



FQP20N60/FQPF20N60

600V,20A N-Channel MOSFET

General Description

The FQP20N60 & FQPF20N60 have been fabricated using an advanced high voltage MOSFET process that is designed to deliver high levels of performance and robustness in popular AC-DC applications. By providing low $R_{DS(on)}$, C_{iss} and C_{rss} along with guaranteed avalanche capability these parts can be adopted quickly into new and existing offline power supply designs.

Product Summary

V_{DS}	700V@150°C
I_D (at $V_{GS}=10V$)	20A
$R_{DS(on)}$ (at $V_{GS}=10V$)	< 0.37Ω

100% UIS Tested
100% R_g Tested



Top View

TO-220

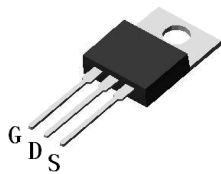

TO-220F

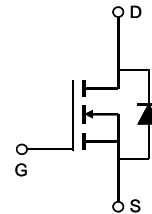
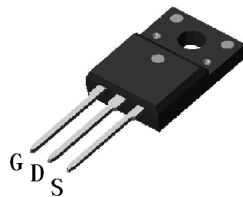

Absolute Maximum Ratings $T_A=25^\circ\text{C}$ unless otherwise noted

Parameter	Symbol	FQP20N60	FQPF20N60	Units
Drain-Source Voltage	V_{DS}	600		V
Gate-Source Voltage	V_{GS}	±30		V
Continuous Drain Current	I_D	$T_C=25^\circ\text{C}$	20	20*
		$T_C=100^\circ\text{C}$	12	12*
Pulsed Drain Current ^C	I_{DM}	80		A
Avalanche Current ^C	I_{AR}	6.5		A
Repetitive avalanche energy ^C	E_{AR}	630		mJ
Single plused avalanche energy ^G	E_{AS}	1260		mJ
Peak diode recovery dv/dt	dv/dt	5		V/ns
Power Dissipation ^B	P_D	$T_C=25^\circ\text{C}$	417	50
		Derate above 25°C	3.3	0.4
Junction and Storage Temperature Range	T_J, T_{STG}	-55 to 150		°C
Maximum lead temperature for soldering purpose, 1/8" from case for 5 seconds	T_L	300		°C

Thermal Characteristics

Parameter	Symbol	FQP20N60	FQPF20N60	Units
Maximum Junction-to-Ambient ^{A,D}	$R_{\theta JA}$	65	65	°C/W
Maximum Case-to-sink ^A	$R_{\theta CS}$	0.5	--	°C/W
Maximum Junction-to-Case	$R_{\theta JC}$	0.3	2.5	°C/W

* Drain current limited by maximum junction temperature.

Electrical Characteristics (T_J=25°C unless otherwise noted)

Symbol	Parameter	Conditions	Min	Typ	Max	Units
STATIC PARAMETERS						
BV _{DSS}	Drain-Source Breakdown Voltage	I _D =250μA, V _{GS} =0V, T _J =25°C	600			V
		I _D =250μA, V _{GS} =0V, T _J =150°C		700		
BV _{DSS} /ΔT _J	Zero Gate Voltage Drain Current	I _D =250μA, V _{GS} =0V		0.8		V/°C
I _{DSS}	Zero Gate Voltage Drain Current	V _{DS} =600V, V _{GS} =0V			1	μA
		V _{DS} =480V, T _J =125°C			10	
I _{GSS}	Gate-Body leakage current	V _{DS} =0V, V _{GS} =±30V			±100	nA
V _{GS(th)}	Gate Threshold Voltage	V _{DS} =5V, I _D =250μA	3.2	3.8	4.5	V
R _{DS(ON)}	Static Drain-Source On-Resistance	V _{GS} =10V, I _D =10A		0.29	0.37	Ω
g _{FS}	Forward Transconductance	V _{DS} =40V, I _D =10A		25		S
V _{SD}	Diode Forward Voltage	I _S =1A, V _{GS} =0V		0.69	1	V
I _S	Maximum Body-Diode Continuous Current				20	A
I _{SM}	Maximum Body-Diode Pulsed Current				80	A
DYNAMIC PARAMETERS						
C _{iss}	Input Capacitance	V _{GS} =0V, V _{DS} =25V, f=1MHz	2448	3061	3680	pF
C _{oss}	Output Capacitance		190	273	360	pF
C _{rss}	Reverse Transfer Capacitance		13	22.8	35	pF
R _g	Gate resistance	V _{GS} =0V, V _{DS} =0V, f=1MHz	0.7	1.4	2.1	Ω
SWITCHING PARAMETERS						
Q _g	Total Gate Charge	V _{GS} =10V, V _{DS} =480V, I _D =20A	48	61	74	nC
Q _{gs}	Gate Source Charge		14	18	22	nC
Q _{gd}	Gate Drain Charge		12	24	36	nC
t _{D(on)}	Turn-On DelayTime	V _{GS} =10V, V _{DS} =300V, I _D =20A, R _G =25Ω		57		ns
t _r	Turn-On Rise Time			125		ns
t _{D(off)}	Turn-Off DelayTime			128		ns
t _f	Turn-Off Fall Time			88		ns
t _{rr}	Body Diode Reverse Recovery Time	I _F =20A, di/dt=100A/μs, V _{DS} =100V	384	480	580	ns
Q _{rr}	Body Diode Reverse Recovery Charge	I _F =20A, di/dt=100A/μs, V _{DS} =100V	8	10.5	13	μC

- A. The value of R_{θJA} is measured with the device in a still air environment with T_A=25° C.
- B. The power dissipation P_D is based on T_{J(MAX)}=150° C, using junction-to-case thermal resistance, and is more useful in setting the upper dissipation limit for cases where additional heatsinking is used.
- C. Repetitive rating, pulse width limited by junction temperature T_{J(MAX)}=150° C, Ratings are based on low frequency and duty cycles to keep initial T_J=25° C.
- D. The R_{θJA} is the sum of the thermal impedance from junction to case R_{θJC} and case to ambient.
- E. The static characteristics in Figures 1 to 6 are obtained using <300 μs pulses, duty cycle 0.5% max.
- F. These curves are based on the junction-to-case thermal impedance which is measured with the device mounted to a large heatsink, assuming a maximum junction temperature of T_{J(MAX)}=150° C. The SOA curve provides a single pulse rating.
- G. L=60mH, I_{AS}=6.5A, V_{DD}=150V, R_G=25Ω, Starting T_J=25° C

TYPICAL ELECTRICAL AND THERMAL CHARACTERISTICS

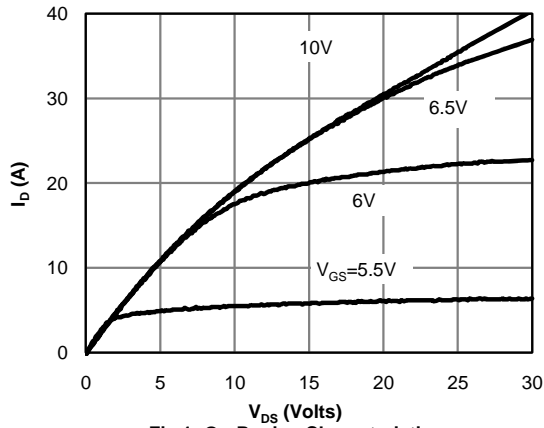

Fig 1: On-Region Characteristics

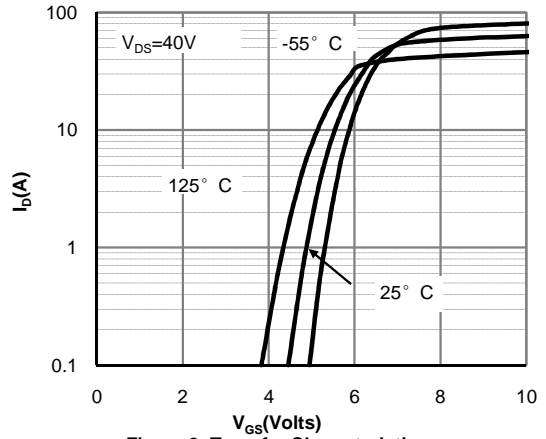

Figure 2: Transfer Characteristics

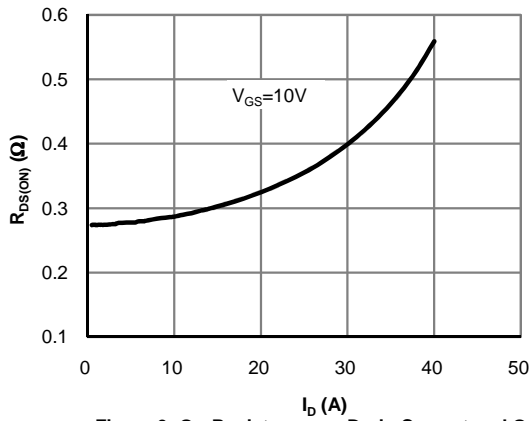

Figure 3: On-Resistance vs. Drain Current and Gate Voltage

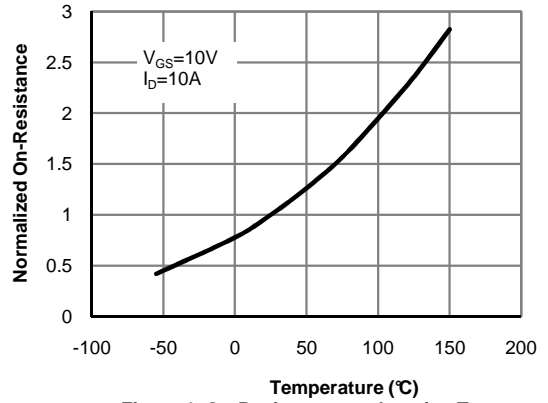

Figure 4: On-Resistance vs. Junction Temperature

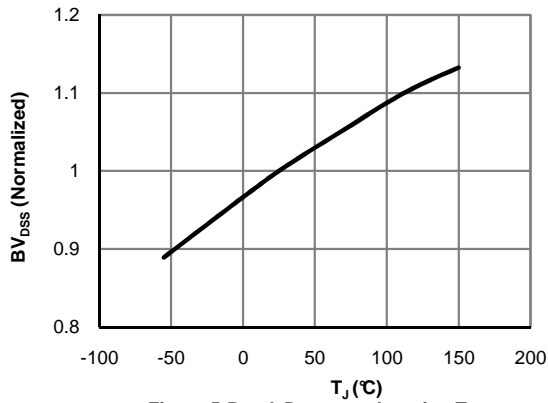

Figure 5: Break Down vs. Junction Temperature

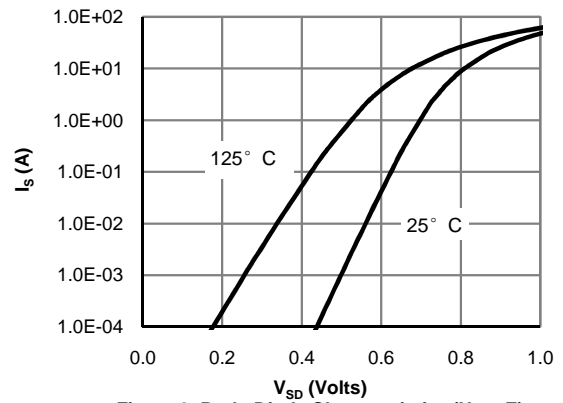

Figure 6: Body-Diode Characteristics (Note E)

TYPICAL ELECTRICAL AND THERMAL CHARACTERISTICS

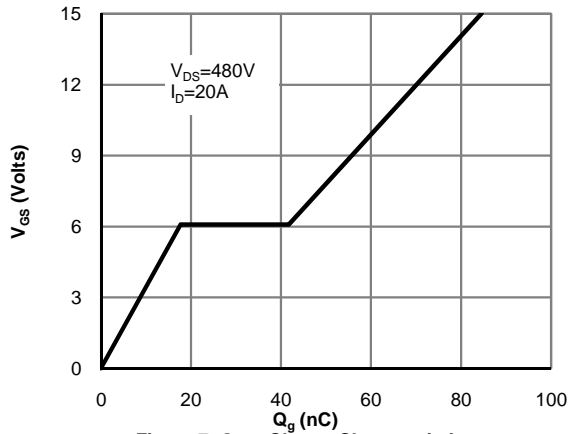

Figure 7: Gate-Charge Characteristics

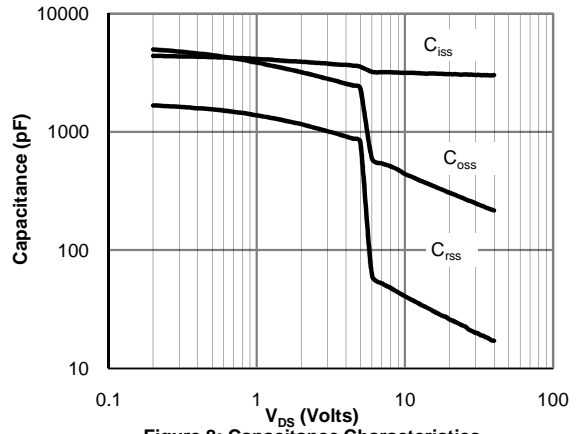

Figure 8: Capacitance Characteristics

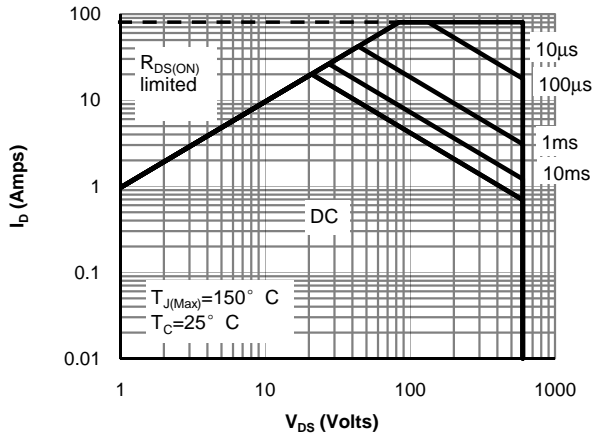

Figure 9: Maximum Forward Biased Safe Operating Area for AOT20N60 (Note F)

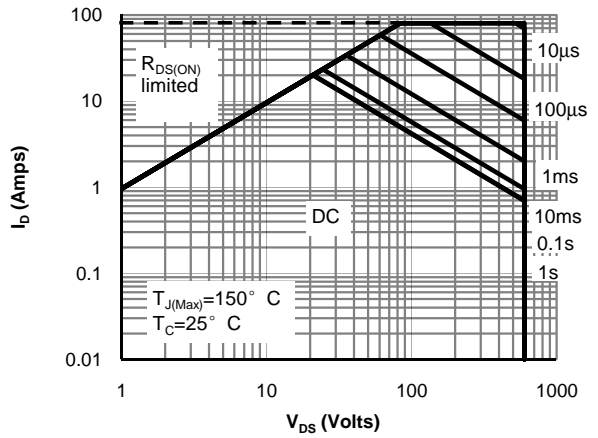

Figure 10: Maximum Forward Biased Safe Operating Area for AOTF20N60 (Note F)

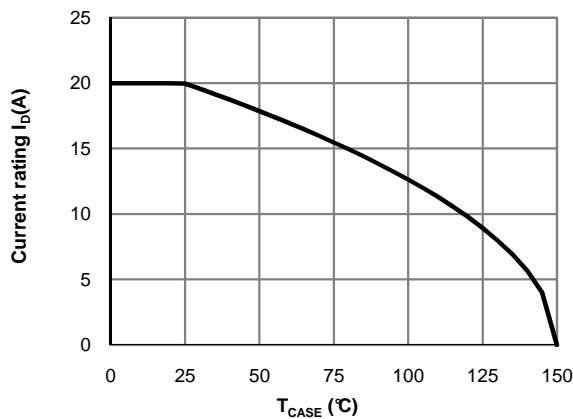

Figure 11: Current De-rating (Note B)

TYPICAL ELECTRICAL AND THERMAL CHARACTERISTICS

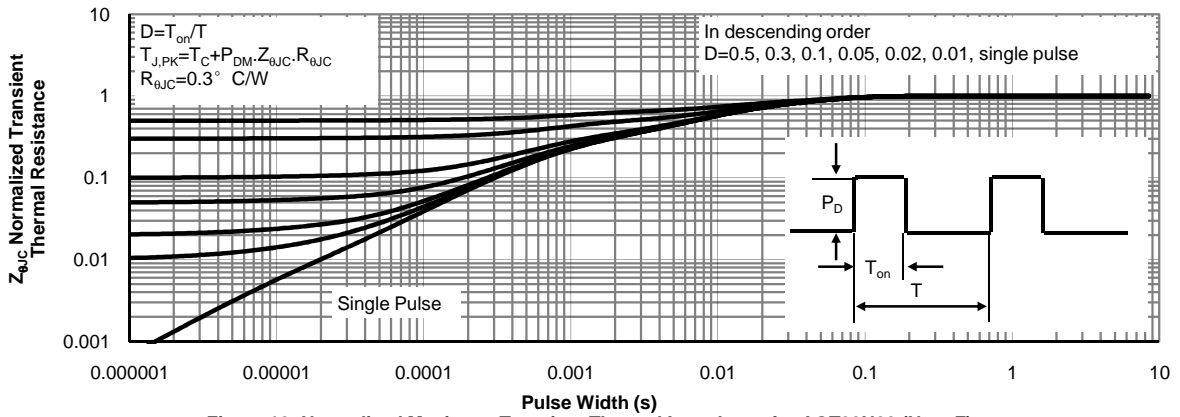

Figure 12: Normalized Maximum Transient Thermal Impedance for AOT20N60 (Note F)

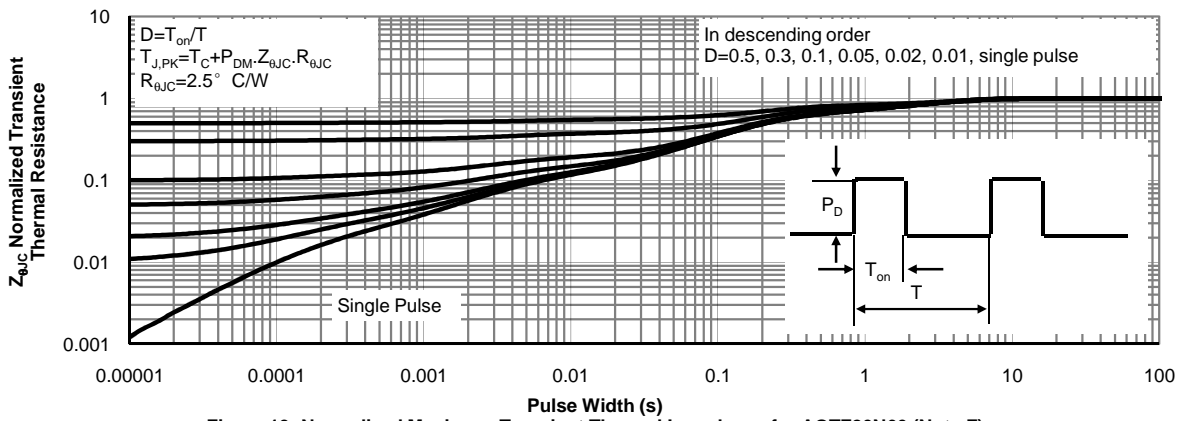
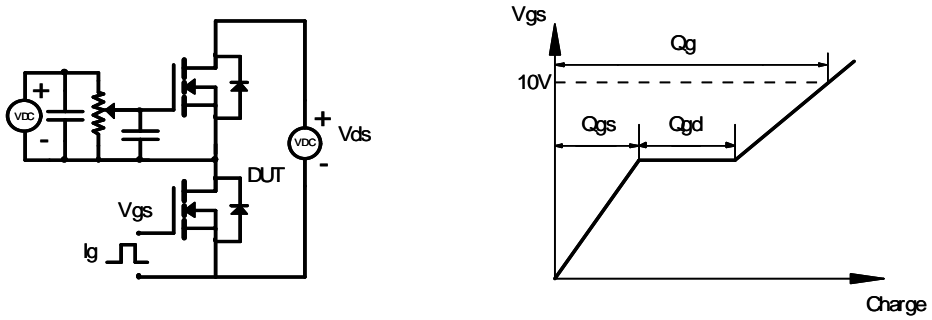
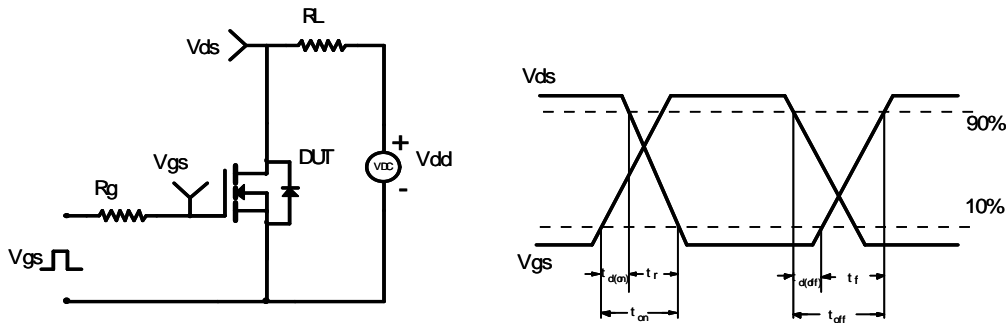

Figure 13: Normalized Maximum Transient Thermal Impedance for AOTF20N60 (Note F)

Gate Charge Test Circuit & Waveform



Resistive Switching Test Circuit & Waveforms



Unclamped Inductive Switching (UIS) Test Circuit & Waveforms

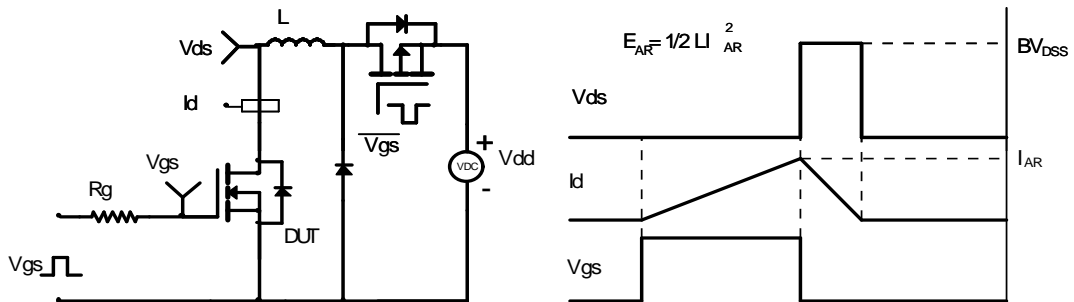

Diode Recovery Test Circuit & Waveforms

