

NE645/646

Dolby Noise Reduction Circuit

Product Specification

DESCRIPTION

The NE645/646 is a monolithic audio noise reduction circuit designed as a direct replacement device for the NE645B/NE646B in Dolby® B-Type noise reduction systems. The NE645/646 is used to reduce the level of background noise introduced during recording and playback of audio signals on magnetic tape, and to improve the noise level in FM broadcast reception. This circuit is available only to licensees of Dolby Laboratories Licensing Corporation, San Francisco, California.

NOTE:

*T.M. Dolby Laboratories Licensing Corporation.

FEATURES

- Accurate record mode frequency response
- Excellent frequency response tracking with temperature and $V_{CC} \pm 0.4$ dB typical
- Excellent back-to-back dynamic response — DC shift less than 20mV typical
- Improved stability of all op amps
- High reliability packaging

APPLICATIONS

- Tape decks
- Dolby surround sound system

PIN CONFIGURATION

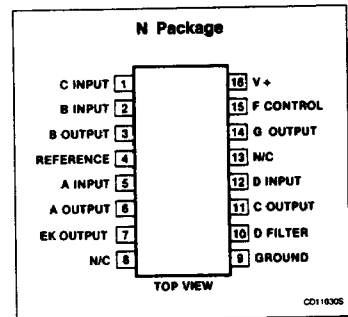

ORDERING INFORMATION

DESCRIPTION	TEMPERATURE RANGE	ORDER CODE
16-Pin Plastic DIP	0 to +70°C	NE645N
16-Pin Plastic DIP	0 to +70°C	NE646N

BLOCK DIAGRAM

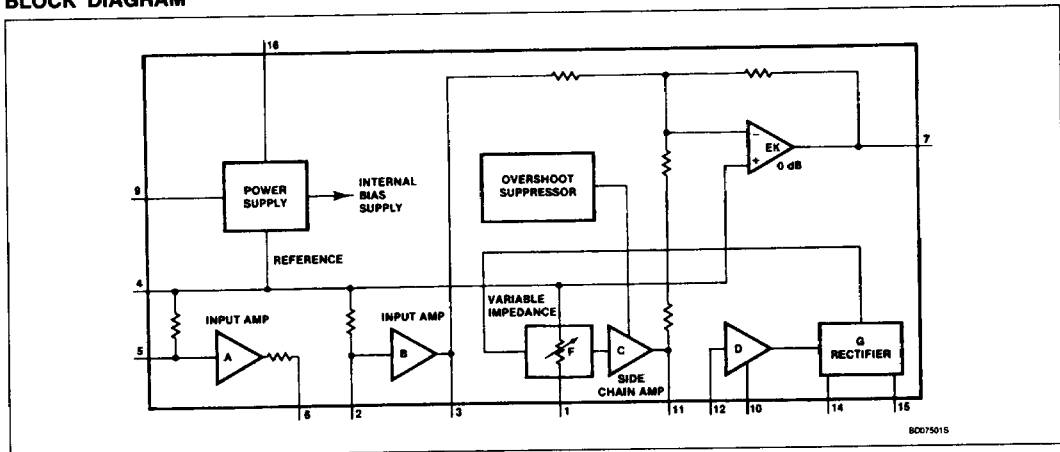

Dolby Noise Reduction Circuit

NE645/646

ABSOLUTE MAXIMUM RATINGS

SYMBOL	PARAMETER	RATING	UNIT
V _{CC}	Supply voltage	24	V
T _A T _{STG}	Temperature range Operating ambient Storage	0 to +70 -65 to +150	°C °C
T _{SOLD}	Lead soldering temperature (10sec max)	+300	°C

DC ELECTRICAL CHARACTERISTICS V_{CC} = 12V, f = 20kHz to 20kHz. All levels referenced to 580mV_{RMS} (0dB) at Pin 3, T_A = +25°C, unless otherwise specified.

SYMBOL	PARAMETER	TEST CONDITIONS	NE645			NE646			UNIT
			Min	Typ	Max	Min	Typ	Max	
V _{CC}	Supply Voltage Range		8		20	8		20	V
I _{CC}	Supply Current	V _{CC} = 12V		16	24		16	24	mA
A _V	Voltage gain (Pins 5-3)	f = 1kHz (Pins 6 and 2 connected)	24.5	26	27.5	24.5	26	27.5	dB
A _V	Voltage gain (Pins 3-7)	f = 1kHz, 0 dB at Pin 3, noise reduction out	-0.5	0	+0.5	-0.5	0	+0.5	dB
	Distortion THD, 2nd and 3rd harmonic	f = 20Hz - 10 kHz, 0dB f = 20Hz - 10 kHz, +10dB		0.05	0.1		0.05	0.2	%
				0.15	0.3		0.2	0.5	%
	Signal handling ¹ (V _{CC} = 12V)	1% dist at 1kHz	+12	+15		+12	+15		dB
S/N	Signal-to-noise ratio ²	Record mode	67	72		64	72		dB
		Playback mode	77	82		74	82		dB
	Record mode Frequency response (at Pin 7) referenced to encode monitor point (Pin 3)	f = 1.4kHz 0dB -20dB -30dB	-1	0	+1	-1.5	0	+1.5	dB
			-16.6	-15.6	-14.6	-17.1	-15.6	-14.1	dB
			-23.5	-22.5	-21.5	-24.0	-22.5	-21.0	dB
		f = 5kHz 0dB -20dB -30dB -40dB	-0.7	+0.3	+1.3	-1.2	+0.3	+1.8	dB
			-17.8	-16.8	-15.8	-18.3	-16.8	-15.3	dB
			-22.8	-21.8	-20.8	-23.3	-21.8	-20.3	dB
		f = 20kHz 0dB -20dB -30dB	-30.2	-29.7	-28.7	-30.2	-29.7	-28.2	dB
			-0.3	+0.7	+1.7	-0.8	+0.7	+2.2	dB
			-18.3	-17.3	-16.3	-18.8	-17.3	-15.8	dB
			-24.5	-23.5	-22.5	-25.0	-23.5	-22.0	dB
	Back-to-back frequency response	Using typical record mode .5 frequency response test points	-1	0	+1	-1.5	0	+1.5	dB
R _{IN}	Input resistance	Pin 5	35	50	65	35	50	65	kΩ
		Pin 2	3.1	4.2	5.3	3.1	4.2	5.3	kΩ
R _{OUT}	Output resistance	Pin 6	1.9	2.4	3.1	1.9	2.4	3.1	kΩ
		Pin 3		80	120		80	120	Ω
		Pin 7		80	120		80	120	Ω
	Back-to-back frequency response shift vs temperature vs supply voltage	0°C to +70°C 8 - 20V		±0.4 ±0.4			±0.4 ±0.4		dB

NOTES:

- See maximum signal handling versus supply voltage characteristics.
- All noise levels are measured CCIR/ARM weighted using a 10k source with respect to Dolby level. See Dolby Laboratories Bulletin 19.

Dolby Noise Reduction Circuit

NE645/646

TYPICAL PERFORMANCE CHARACTERISTICS

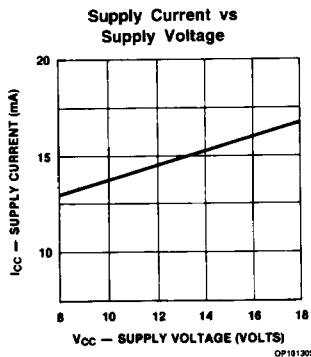
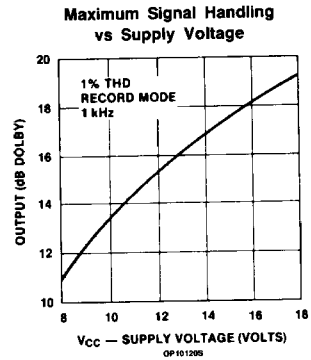
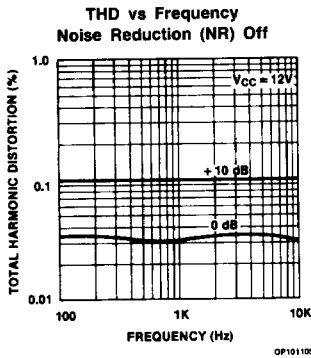
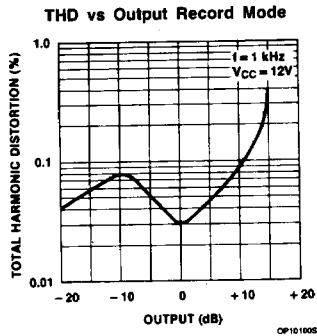
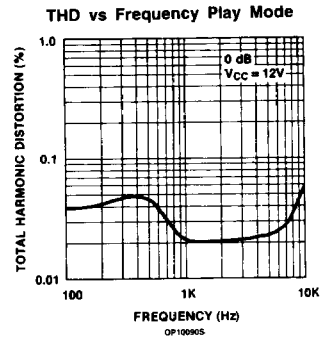
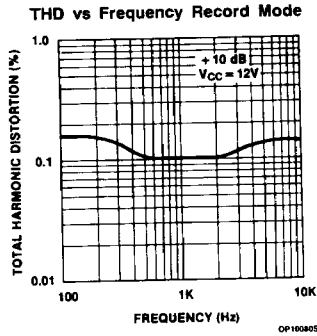
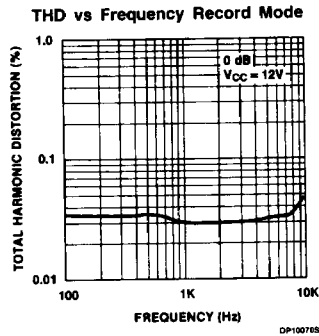

APPLICATION INFORMATION

The NE645/646 is a direct replacement for the NE645B/646B. The NE645/646 incorpo-

rates improved design techniques to insure excellent performance required in Dolby B and C Type Audio Noise Reduction Systems. Critical component values are unchanged

except for C309 on Pin 1 which is now an optional component in specific applications defined by Dolby Laboratories. All circuit parameters are guaranteed at 12V V_{CC}.

Dolby Noise Reduction Circuit

NE645/646

DOLBY ENCODER Output for constant level input (single tone frequency response)

Frequency (kHz)	Input Level (dB)								
	0 (Dolby Level)	-5	-10	-15	-20	-25	-30	-35	-40
0.1	0	0.1	0	0.1	0	0	0	0	0
0.14	0	0.2	0.2	0.2	0.2	0.2	0.1	0.2	0.1
0.2	0	0.3	0.4	0.5	0.5	0.6	0.6	0.5	0.5
0.3	0	0.3	0.6	1.1	1.3	1.3	1.3	1.3	1.3
0.4					2.0	2.1	2.2	2.3	2.1
0.5	0	0.3	0.8	1.8	2.6	2.9	2.9	3.0	2.9
0.6						3.6	3.7	3.8	3.7
0.7	0	0.4	0.9	2.1	3.5	4.3	4.4	4.5	4.4
0.8						4.8	5.0	5.3	5.1
0.9							5.6	5.8	5.6
1.0	0	0.4	1.0	2.3	4.2	5.7	6.1	6.3	6.2
1.2							6.9	7.1	7.1
1.4	0	0.3	0.9	2.3	4.4	6.6	7.5	7.7	7.7
2.0	0.1	0.4	0.9	2.2	4.3	7.0	8.5	8.9	8.9
3.0	0.2	0.6	0.9	1.9	3.9	6.6	8.8	9.7	9.7
5.0	0.3	0.6	1.0	1.7	3.2	5.4	8.2	10.0	10.3
7.0	0.3	0.6	1.0	1.7	2.8	4.7	7.3	9.7	10.4
10.0	0.4	0.7	1.1	1.7	2.6	4.2	6.5	9.1	10.4
14.0	0.5	0.8	1.1	1.8	2.7	4.4	6.5	8.7	10.3
20.0	0.7	0.7	1.2	1.9	2.7	4.4	6.5	8.7	10.3

NOTE:

The figures given in this table are the average response of many of Dolby Laboratories' professional encoders, and are not intended to be taken as required consumer equipment performance characteristics. Thus, no inference should be drawn on the tolerances which licensees must retain in consumer equipment. The figures can, however, be used to plot typical characteristics.

Dolby Noise Reduction Circuit

NE645/646

TEST CIRCUIT

