

MUR8100E, MUR880E

MUR8100E is a Preferred Device

SWITCHMODE™ Power Rectifiers

Ultrafast “E” Series with High Reverse Energy Capability

The MUR8100 and MUR880E diodes are designed for use in switching power supplies, inverters and as free wheeling diodes.

Features

- 20 mJ Avalanche Energy Guaranteed
- Excellent Protection Against Voltage Transients in Switching Inductive Load Circuits
- Ultrafast 75 Nanosecond Recovery Time
- 175°C Operating Junction Temperature
- Popular TO-220 Package
- Epoxy Meets UL 94 V-0 @ 0.125 in.
- Low Forward Voltage
- Low Leakage Current
- High Temperature Glass Passivated Junction
- Reverse Voltage to 1000 V
- Pb-Free Packages are Available*

Mechanical Characteristics:

- Case: Epoxy, Molded
- Weight: 1.9 Grams (Approximately)
- Finish: All External Surfaces Corrosion Resistant and Terminal Leads are Readily Solderable
- Lead Temperature for Soldering Purposes:
260°C Max. for 10 Seconds



ON Semiconductor®

<http://onsemi.com>

ULTRAFAST RECTIFIERS 8.0 A, 800 V – 1000 V

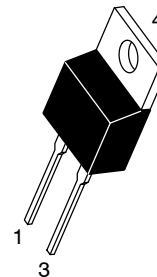
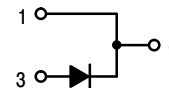

TO-220AC
CASE 221B

MARKING DIAGRAM



- A = Assembly Location
- Y = Year
- WW = Work Week
- G = Pb-Free Package
- U8xxxE = Device Code
xxx = 100 or 80
- KA = Diode Polarity

ORDERING INFORMATION

Device	Package	Shipping
MUR8100E	TO-220	50 Units / Rail
MUR8100EG	TO-220 (Pb-Free)	50 Units / Rail
MUR880E	TO-220	50 Units / Rail
MUR880EG	TO-220 (Pb-Free)	50 Units / Rail

*For additional information on our Pb-Free strategy and soldering details, please download the ON Semiconductor Soldering and Mounting Techniques Reference Manual, SOLDERRM/D.

Preferred devices are recommended choices for future use and best overall value.

MUR8100E, MUR880E

MAXIMUM RATINGS

Rating	Symbol	Value	Unit
Peak Repetitive Reverse Voltage Working Peak Reverse Voltage DC Blocking Voltage	V_{RRM} V_{RWM} V_R	800 1000	V
Average Rectified Forward Current (Rated V_R , $T_C = 150^\circ\text{C}$) Total Device	$I_{F(AV)}$	8.0	A
Peak Repetitive Forward Current (Rated V_R , Square Wave, 20 kHz, $T_C = 150^\circ\text{C}$)	I_{FM}	16	A
Non-Repetitive Peak Surge Current (Surge Applied at Rated Load Conditions Halfwave, Single Phase, 60 Hz)	I_{FSM}	100	A
Operating Junction and Storage Temperature Range	T_J, T_{stg}	-65 to +175	$^\circ\text{C}$

Stresses exceeding Maximum Ratings may damage the device. Maximum Ratings are stress ratings only. Functional operation above the Recommended Operating Conditions is not implied. Extended exposure to stresses above the Recommended Operating Conditions may affect device reliability.

THERMAL CHARACTERISTICS

Characteristic	Symbol	Value	Unit
Maximum Thermal Resistance, Junction-to-Case	$R_{\theta JC}$	2.0	$^\circ\text{C}/\text{W}$

ELECTRICAL CHARACTERISTICS

Characteristic	Symbol	Value	Unit
Maximum Instantaneous Forward Voltage (Note 1) ($I_F = 8.0\text{ A}$, $T_C = 150^\circ\text{C}$) ($I_F = 8.0\text{ A}$, $T_C = 25^\circ\text{C}$)	V_F	1.5 1.8	V
Maximum Instantaneous Reverse Current (Note 1) (Rated DC Voltage, $T_C = 100^\circ\text{C}$) (Rated DC Voltage, $T_C = 25^\circ\text{C}$)	i_R	500 25	μA
Maximum Reverse Recovery Time ($I_F = 1.0\text{ A}$, $di/dt = 50\text{ A}/\mu\text{s}$) ($I_F = 0.5\text{ A}$, $i_R = 1.0\text{ A}$, $I_{REC} = 0.25\text{ A}$)	t_{rr}	100 75	ns
Controlled Avalanche Energy (See Test Circuit in Figure 6)	W_{AVAIL}	20	mJ

1. Pulse Test: Pulse Width = 300 μs , Duty Cycle $\leq 2.0\%$.

MUR8100E, MUR880E

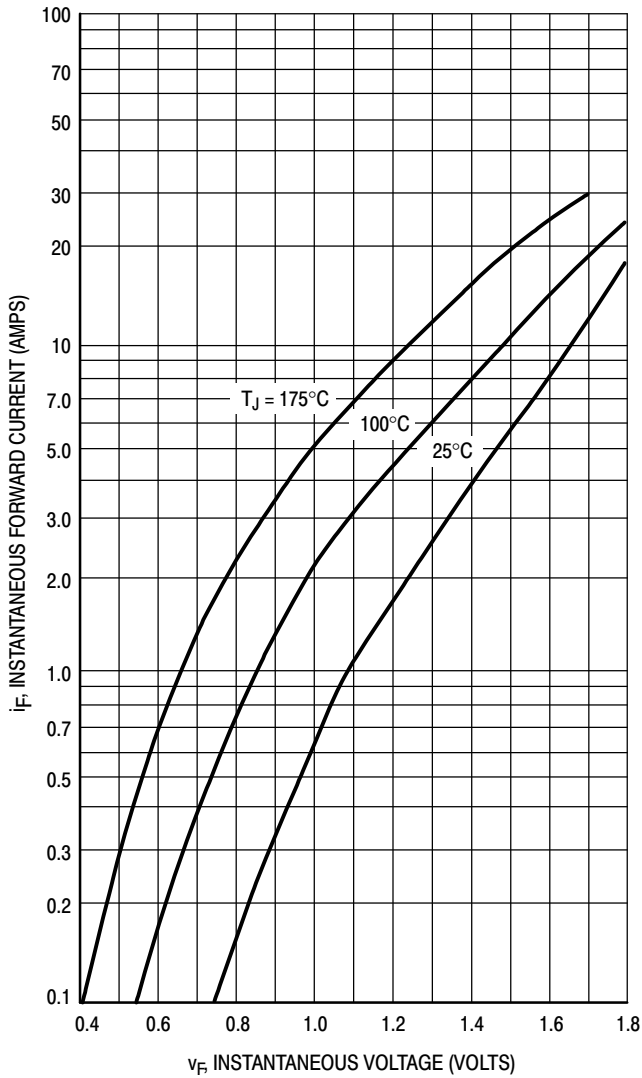

Figure 1. Typical Forward Voltage

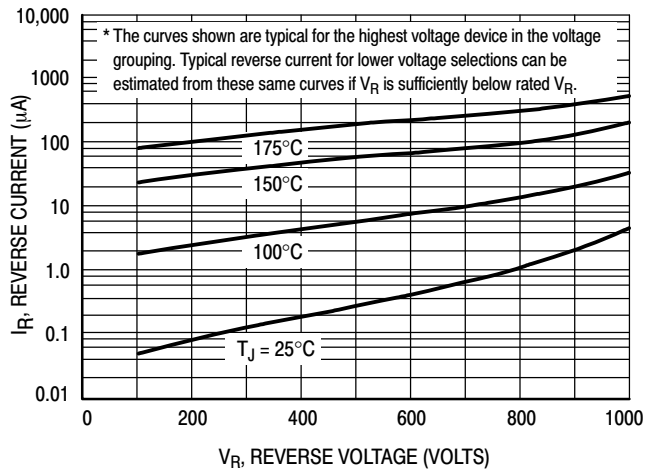

Figure 2. Typical Reverse Current*

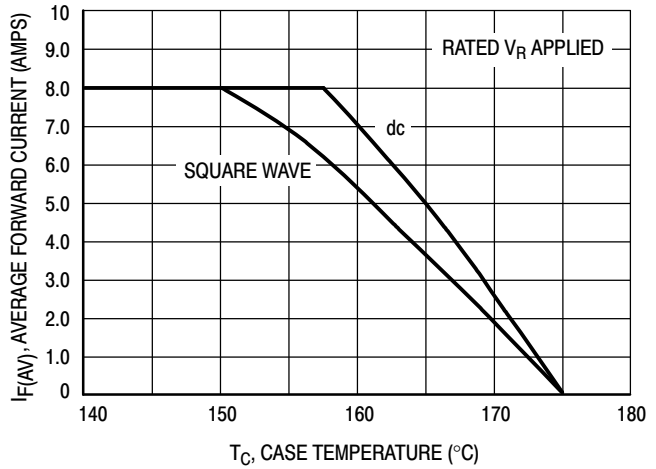

Figure 3. Current Derating, Case

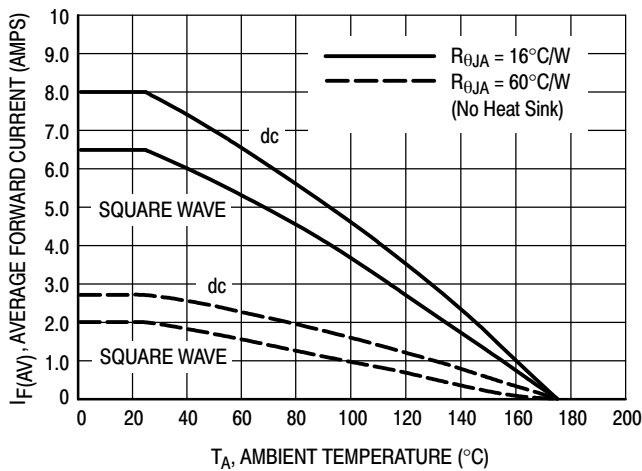

Figure 4. Current Derating, Ambient

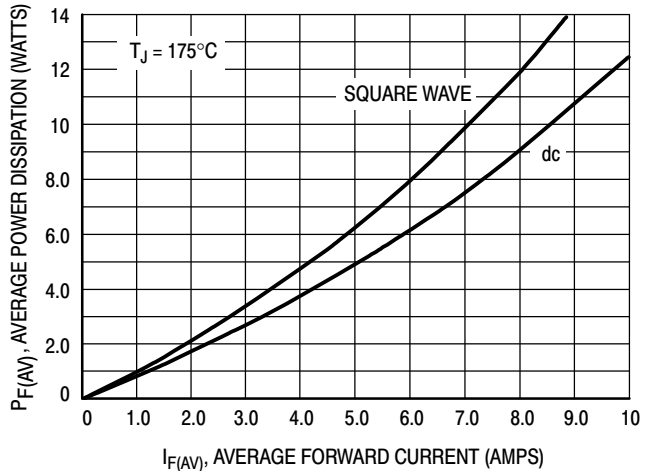

Figure 5. Power Dissipation

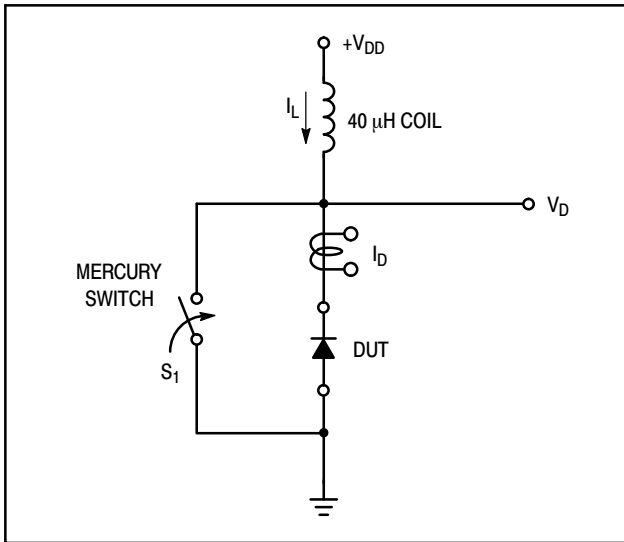

Figure 6. Test Circuit

The unclamped inductive switching circuit shown in Figure 6 was used to demonstrate the controlled avalanche capability of the new “E” series Ultrafast rectifiers. A mercury switch was used instead of an electronic switch to simulate a noisy environment when the switch was being opened.

When S_1 is closed at t_0 the current in the inductor I_L ramps up linearly; and energy is stored in the coil. At t_1 the switch is opened and the voltage across the diode under test begins to rise rapidly, due to di/dt effects, when this induced voltage reaches the breakdown voltage of the diode, it is clamped at BV_{DUT} and the diode begins to conduct the full load current which now starts to decay linearly through the diode, and goes to zero at t_2 .

By solving the loop equation at the point in time when S_1 is opened; and calculating the energy that is transferred to the diode it can be shown that the total energy transferred is equal to the energy stored in the inductor plus a finite amount of energy from the V_{DD} power supply while the diode is in

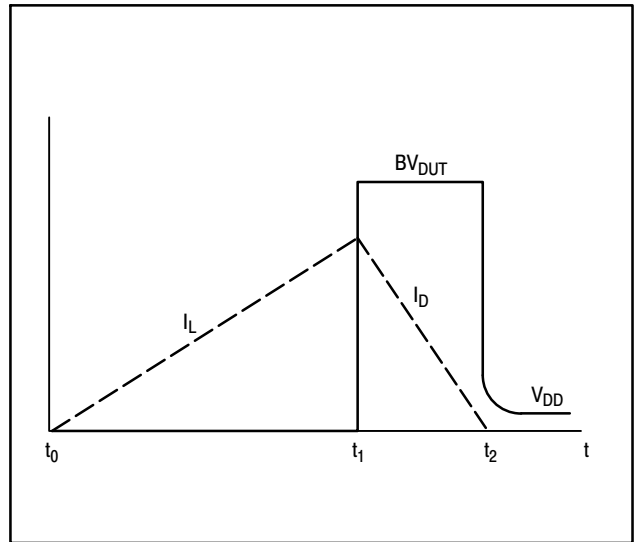

Figure 7. Current–Voltage Waveforms

breakdown (from t_1 to t_2) minus any losses due to finite component resistances. Assuming the component resistive elements are small Equation (1) approximates the total energy transferred to the diode. It can be seen from this equation that if the V_{DD} voltage is low compared to the breakdown voltage of the device, the amount of energy contributed by the supply during breakdown is small and the total energy can be assumed to be nearly equal to the energy stored in the coil during the time when S_1 was closed, Equation (2).

The oscilloscope picture in Figure 8, shows the MUR8100E in this test circuit conducting a peak current of one ampere at a breakdown voltage of 1300 V, and using Equation (2) the energy absorbed by the MUR8100E is approximately 20 mjoules.

Although it is not recommended to design for this condition, the new “E” series provides added protection against those unforeseen transient viruses that can produce unexplained random failures in unfriendly environments.

EQUATION (1):

$$W_{AVAL} \approx \frac{1}{2} L I_{LPK}^2 \left(\frac{BV_{DUT}}{BV_{DUT} - V_{DD}} \right)$$

EQUATION (2):

$$W_{AVAL} \approx \frac{1}{2} L I_{LPK}^2$$

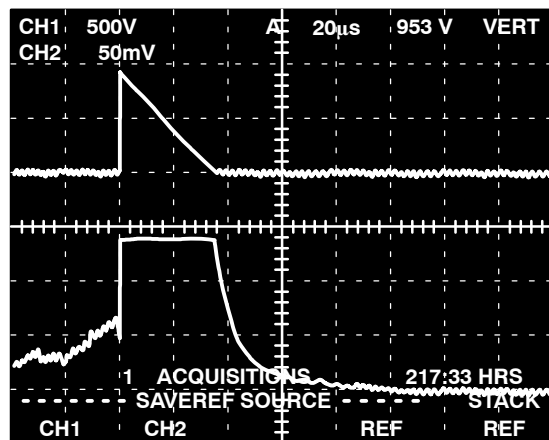

CHANNEL2:

I_L
0.5 AMPS/DIV.

CHANNEL1:

V_{DUT}
500 VOLTS/DIV.

TIME BASE:

20 μ s/DIV.

Figure 8. Current–Voltage Waveforms

MUR8100E, MUR880E

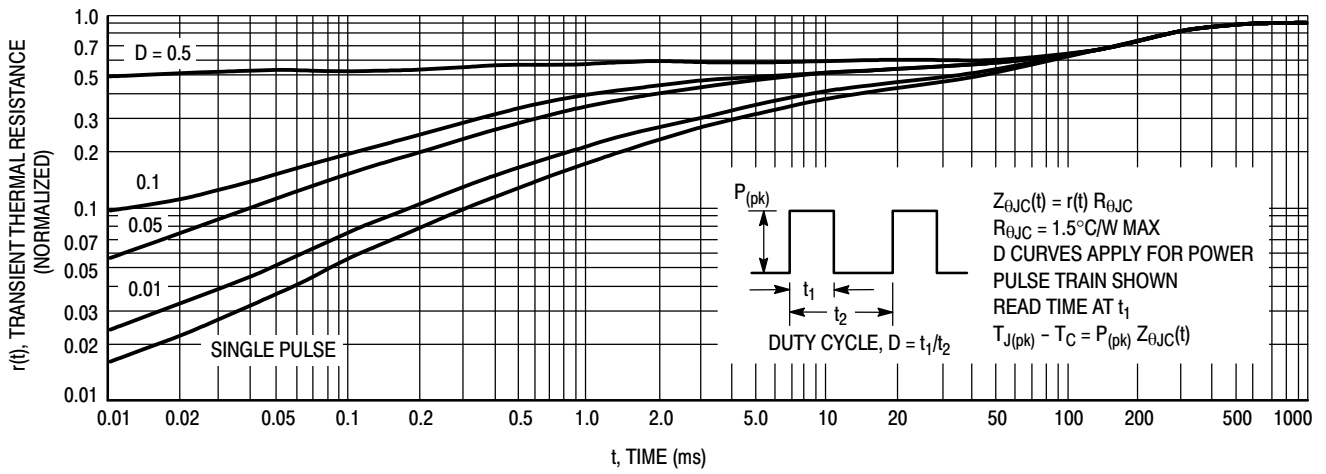

Figure 9. Thermal Response

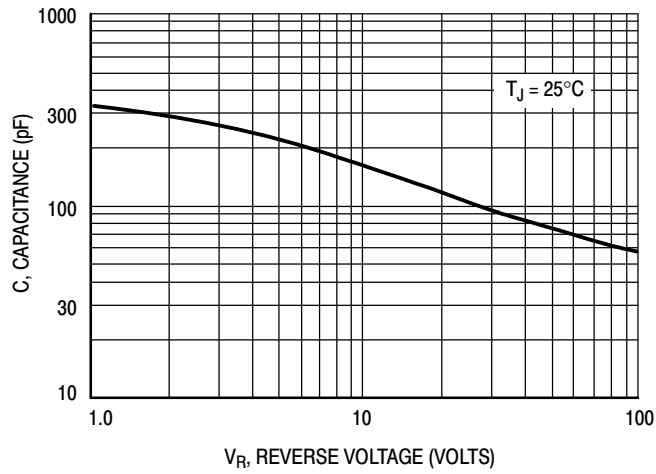

Figure 10. Typical Capacitance

MECHANICAL CASE OUTLINE

PACKAGE DIMENSIONS



TO-220, 2-LEAD CASE 221B-04 ISSUE F

DATE 12 APR 2013



SCALE 1:1

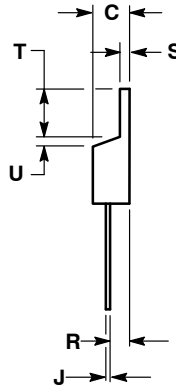
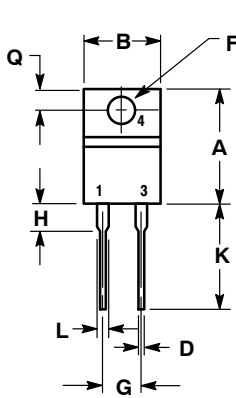

NOTES:

1. DIMENSIONING AND TOLERANCING PER ANSI Y14.5M, 1982.
2. CONTROLLING DIMENSION: INCH.

DIM	INCHES		MILLIMETERS	
	MIN	MAX	MIN	MAX
A	0.595	0.620	15.11	15.75
B	0.380	0.405	9.65	10.29
C	0.160	0.190	4.06	4.82
D	0.025	0.039	0.64	1.00
F	0.142	0.161	3.61	4.09
G	0.190	0.210	4.83	5.33
H	0.110	0.130	2.79	3.30
J	0.014	0.025	0.36	0.64
K	0.500	0.562	12.70	14.27
L	0.045	0.060	1.14	1.52
Q	0.100	0.120	2.54	3.04
R	0.080	0.110	2.04	2.79
S	0.045	0.055	1.14	1.39
T	0.235	0.255	5.97	6.48
U	0.000	0.050	0.000	1.27

STYLE 1:
PIN 1. CATHODE
2. N/A
3. ANODE
4. CATHODE

STYLE 2:
PIN 1. ANODE
2. N/A
3. CATHODE
4. ANODE

DOCUMENT NUMBER:	98ASB42149B	Electronic versions are uncontrolled except when accessed directly from the Document Repository. Printed versions are uncontrolled except when stamped "CONTROLLED COPY" in red.
DESCRIPTION:	TO-220, 2-LEAD	PAGE 1 OF 1

ON Semiconductor and are trademarks of Semiconductor Components Industries, LLC dba ON Semiconductor or its subsidiaries in the United States and/or other countries. ON Semiconductor reserves the right to make changes without further notice to any products herein. ON Semiconductor makes no warranty, representation or guarantee regarding the suitability of its products for any particular purpose, nor does ON Semiconductor assume any liability arising out of the application or use of any product or circuit, and specifically disclaims any and all liability, including without limitation special, consequential or incidental damages. ON Semiconductor does not convey any license under its patent rights nor the rights of others.

ON Semiconductor and  are trademarks of Semiconductor Components Industries, LLC dba ON Semiconductor or its subsidiaries in the United States and/or other countries. ON Semiconductor owns the rights to a number of patents, trademarks, copyrights, trade secrets, and other intellectual property. A listing of ON Semiconductor's product/patent coverage may be accessed at www.onsemi.com/site/pdf/Patent-Marking.pdf. ON Semiconductor reserves the right to make changes without further notice to any products herein. ON Semiconductor makes no warranty, representation or guarantee regarding the suitability of its products for any particular purpose, nor does ON Semiconductor assume any liability arising out of the application or use of any product or circuit, and specifically disclaims any and all liability, including without limitation special, consequential or incidental damages. Buyer is responsible for its products and applications using ON Semiconductor products, including compliance with all laws, regulations and safety requirements or standards, regardless of any support or applications information provided by ON Semiconductor. "Typical" parameters which may be provided in ON Semiconductor data sheets and/or specifications can and do vary in different applications and actual performance may vary over time. All operating parameters, including "Typicals" must be validated for each customer application by customer's technical experts. ON Semiconductor does not convey any license under its patent rights nor the rights of others. ON Semiconductor products are not designed, intended, or authorized for use as a critical component in life support systems or any FDA Class 3 medical devices or medical devices with a same or similar classification in a foreign jurisdiction or any devices intended for implantation in the human body. Should Buyer purchase or use ON Semiconductor products for any such unintended or unauthorized application, Buyer shall indemnify and hold ON Semiconductor and its officers, employees, subsidiaries, affiliates, and distributors harmless against all claims, costs, damages, and expenses, and reasonable attorney fees arising out of, directly or indirectly, any claim of personal injury or death associated with such unintended or unauthorized use, even if such claim alleges that ON Semiconductor was negligent regarding the design or manufacture of the part. ON Semiconductor is an Equal Opportunity/Affirmative Action Employer. This literature is subject to all applicable copyright laws and is not for resale in any manner.

PUBLICATION ORDERING INFORMATION

LITERATURE FULFILLMENT:

Email Requests to: orderlit@onsemi.com

ON Semiconductor Website: www.onsemi.com

TECHNICAL SUPPORT

North American Technical Support:
Voice Mail: 1 800-282-9855 Toll Free USA/Canada
Phone: 011 421 33 790 2910

Europe, Middle East and Africa Technical Support:

Phone: 00421 33 790 2910

For additional information, please contact your local Sales Representative