

Cold Cathode Fluorescent Lamp CCFL-Inverter

Cold Cathode Fluorescent Lamp

CCFL-Inverter

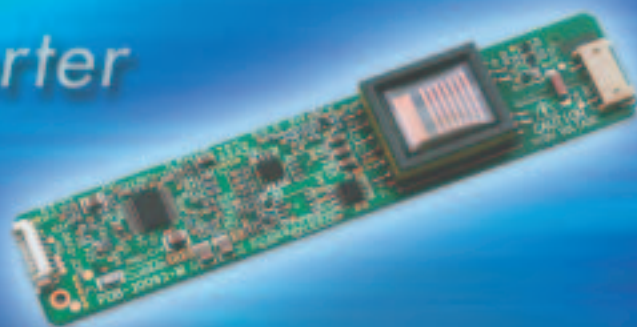

Brighter, Thinner and More Efficient . . .

Sanken Total Solution for

— From CCFLs (Cold Cathode Fluorescent Lamps) to Devices, Inverters and Power Supply Modules —

Liquid crystal displays such as those in TV sets and monitors are larger in size, brighter and sharper almost every day. Sanken offers CCFLs with high luminance and long life, power supplies with small size and large capacity and power supply ICs with high efficiency and low noise. They are developed and manufactured under Sanken's consistent system, just starting from the production of semiconductors. Sanken contributes to the improvement of image quality, thinning and shrinking and energy saving of these modern displays by offering a unique total solution.

Notebook PC

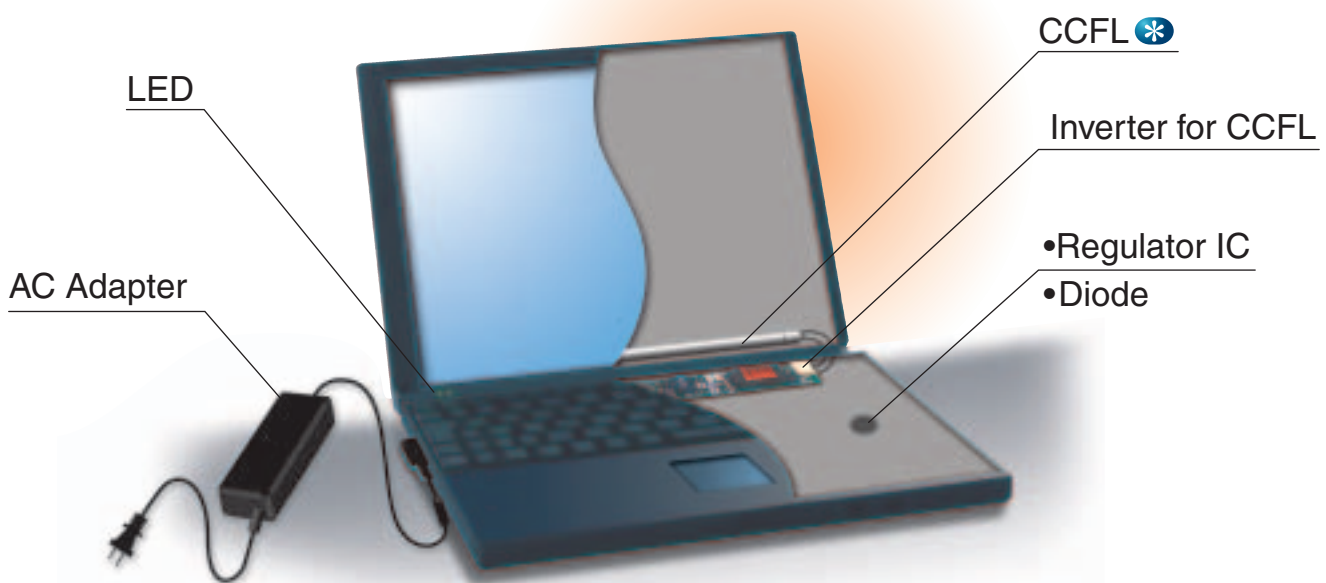

* Example for a 15" display:
308 mm length CCFL x 1

Displays

LCD monitor

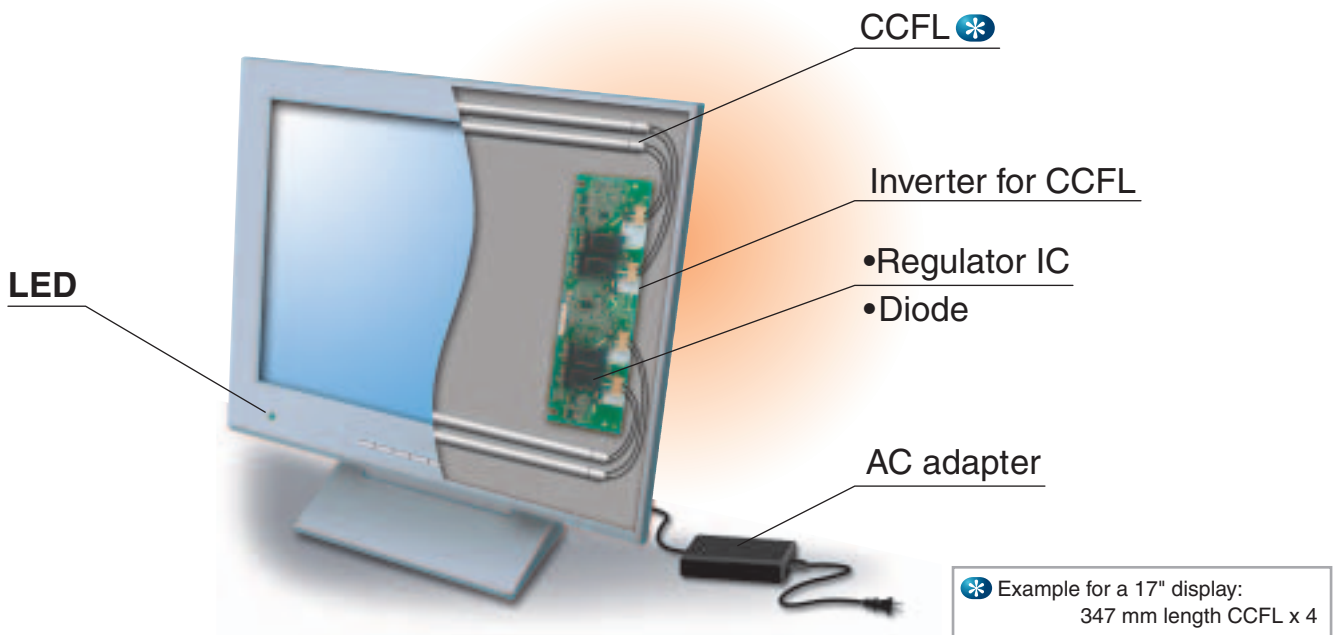

LCD television

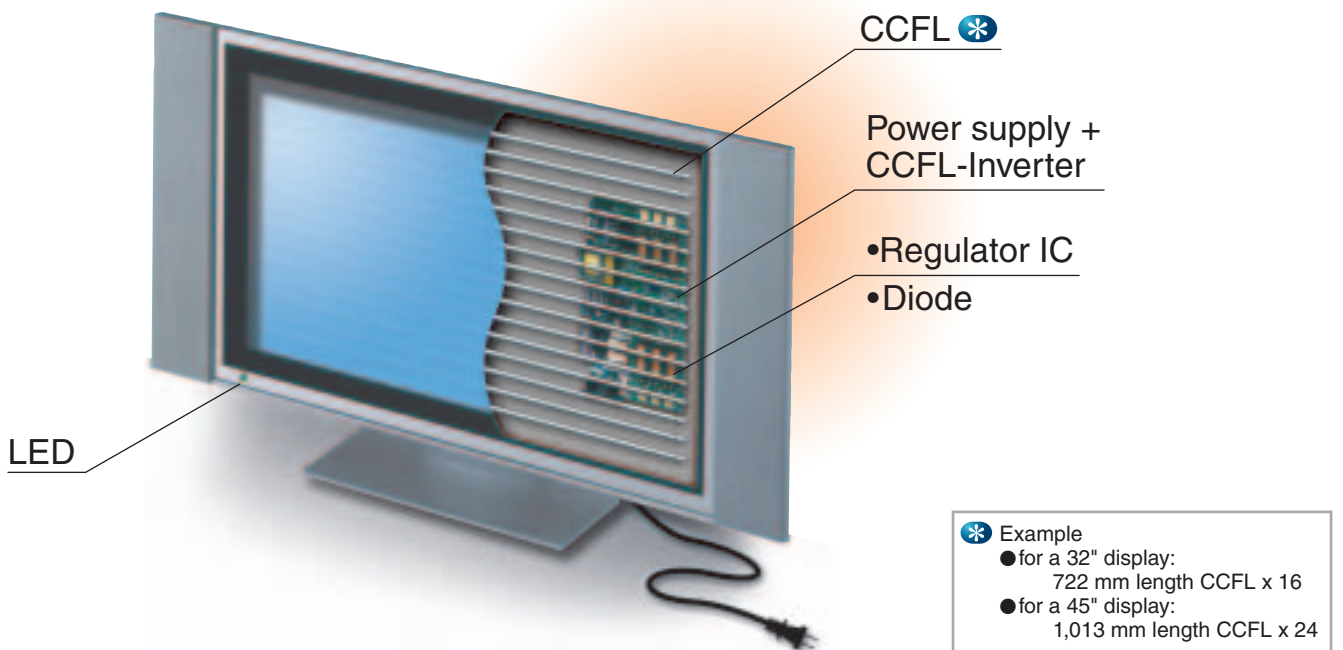

Application Notices for Using CCFL & Inverter

When using the products described in this catalog, please take into consideration the application notices for a safety design.

The misuse of products might cause electric shock, damage, combustion, etc.

When individual/specific notices exist in addition to these application notices, the individual/specific notices shall prevail.

When you adopt our products, please conclude a contract for the confirmation of the specifications, and use them properly based on the recommendation and notice described.

Caution:

- As the products described in this catalog possess high voltage, please do not touch when operated. Otherwise, electric shock may happen.

Notice:

- The contents of this catalog are subject to change without notice for modification.
Please check updated information when using.
- As the products described in this catalog are specifically designed to drive CCFL, please do not use the products for other applications.
- The products described in this catalog should be stored under the conditions specified in the catalog and specifications.
- Please do not store the products in an environment of dusty and corrosion gas atmosphere (salt, acid, alkaline, etc.)
- We are always trying to improve the quality and reliability. However, the defects and malfunction are inevitable at a certain probability. Therefore, as a responsibility of a user, please ensure safety design and verification in the equipment and whole system not to cause human accident, fire, social damage etc. as a result of the product failure.
- As the products are designed to be used in general electric equipment (homeappliances, office equipment, communication terminals, measuring equipment,

etc.), please provide the adequate fail-safe protection, when using the products in the medical equipment which treats the human life directly or for the control of transportation vehicle the failure of which may endanger the human lives.

- Please do not use the products in an environment of high temperature, high humidity, dust or corrosive gas atmosphere.
Please use them in dew-free condition to prevent the damage and electric shock.
- Although a protection circuit is built-in, it may malfunction depending on the application conditions and power supply capacity. In such cases, it is recommended to provide an individual protection circuit.
- Please provide the protection against the surge voltage due to lightning. Abnormal voltage may cause damage.
- To avoid the failure by a short circuit at high voltage portion, please prevent any foreign article from entering after assembling.
- As CCFL contains mercury gas, it is dangerous to inhale it. when the CCFL is broken.
- The products are not designed to assure the radiation ray-proof.
- The contents of this catalog should not be duplicated or transcribed without our prior written consent.

Notices for Handling:

- As the products use thin wire, please refrain from the following actions not to cause wire break.
Do not stack the products.
Do not touch the product with a tool, etc.
- Please do not apply excessive stress on assembling to avoid the damage by die crack, etc.
- When assembling the products described in this catalog on a chassis, please secure appropriate spacing from high voltage portion in accordance with the safety regulation.
- As CCFL described in this catalog is made of glass, please be careful of shock, drop, etc.

Contents

CCFL

Features	2
Light emitting principle	3
Emission Wavelength of invisible light	3
Ambient Temperature (Lamp Surface Temperature) Characteristics ...	3
Mercury Vapor Pressure and Amount	4
Distribution of Lamp Surface Temperature and Mercury ...	4
Part Numbering System	5
Outline and Structural Drawings	5
Outer Lead	5
Characteristic Diagram	6
Life	9
1 List of Product Lives	9
2 Life Determination	10
3 Precautions at end of Lamp Life	11
4 Examples of Lamp Failures	11
5 Notes on Lamp Lighting Waveform	13
6 Fall of Luminance of CCFL and System	15
Measurement	16
1 Measuring equipments	16
2 Measuring Method	17
3 Selection of Lamp Specifications	20
(Confirmation of Matching of Lamp Specifications and Backlight)	
4 Terminology	21
5 Equipment Error of Topcon Luminance Colorimeter (BM-type)...	22
Difference between Current Dimming and PWM Dimming ...	24
Leakage Current of CCFL at LCD Module	25
Electrical Characteristics in Backlight System	27
1 Lighting start voltage in System	27
2 Lamp Voltage and Lamp Power in System	28

CCFL Inverter

Selection Guide for CCFL-Inverters for Measurement and Aging ...	29
SCF-0278	30
SCF-0281	32
Accessories for SCF-0278/SCF-0281	34
SCF-0290	36

Control IC for CCFL-Inverter

Regulator IC

Linear Regulator IC	39
Switching mode Regulator IC	40
Dual Output Regulator IC	41

Diode

Rectifier Diode	42
Fast Recovery Diode	42
Schottky Barrier Diode	42

AC Adapter

● Features

- We develop leading edge technologies such as hard glass, unique mercury enclosing method, hard outer lead, and cup electrode, and our CCFL is now the de facto standard of CCFL industry.
- Various diameters ($\phi 1.8-4.0$ mm) and lengths (150-1,300 mm) are available for selection.
- By changing phosphor, the color temperature matching each LCD system can be set (4,500K-20,000K).
- Our electrode is low power consumption type at low lamp voltage by the hollow effect of the cup electrode.
- By adopting the cup electrode, longer product life is realized.
- Since the sealed part is closely adhered to the tungsten wire with the compression seal of hard glass, there is no slow leak by heat stress etc. (see the expansion curve of hard glass and tungsten.)
- Our hard glass is excellent in the UV cut effect. Please refer to the Comparison of UV Emissions on page 8. In addition, UV cut glass is also available. Please contact our office.
- By our unique mercury enclosing method, the amount of enclosed mercury can be stabilized, and also adjusted as requested.
- Lighting start voltage, emission efficiency, service life, heat dissipation, lamp voltage, etc. can be selected by the ratio of neon argon mixture gas, enclosure pressure, and type of electrode.
- By our unique phosphor coating method, equalization of a luminance distribution in the lamp axial direction and low luminance degradation are realized. The product with the improved luminance distribution for direct backlight system is also available. Please contact our office.
- The darkness starting characteristic is improved by our unique method. For this reason, since our lamp has polarity, be careful of wire connection.
- By using niobium (Nb) material with the low sputtering rate for the cup electrode, consumption of the mercury by sputtering can be limited for longer life.

[Example] Sputtering rate by mercury ions (Hg^+400eV) = Ni 0.72, Nb 0.34

Due to this effect, short electrode (Nb: 4mm electrode) for Notebook PC and low gas pressure (high luminance and high efficiency) for monitors are achieved.

The expansion curve of hard glass and tungsten

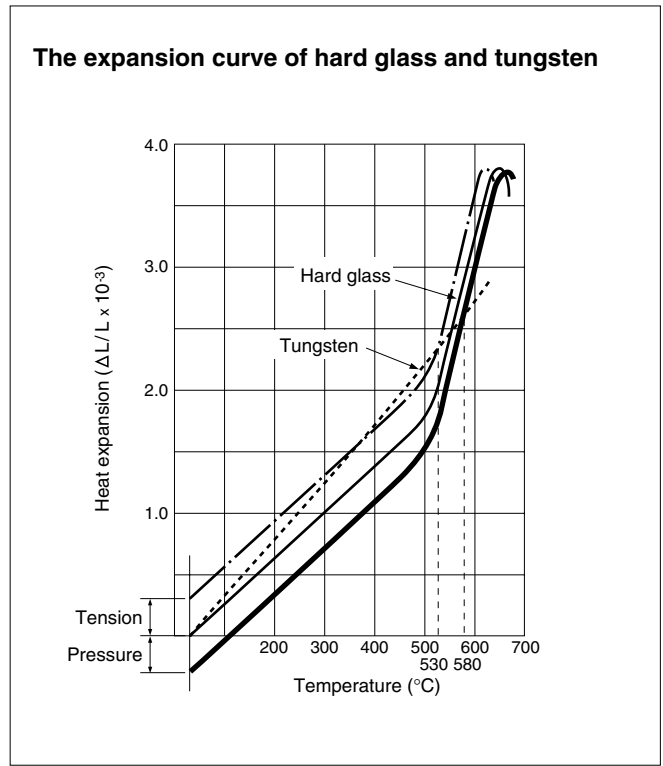

●Light emitting principle

Rare gas (Ne-Ar mixed gas) and appropriate amount of mercury vapor are sealed in the cold cathode fluorescent lamp. When high electric field is applied to the lamp, electrons are accelerated to cause elastic collision with rare gas, with mercury

atoms by adjusting the speed, and then for the radiation of ultraviolet ray (primarily 253.7 nm) is emitted.

Phosphor absorbs the ultraviolet ray and is excited to convert it into visible light by energy conversion.

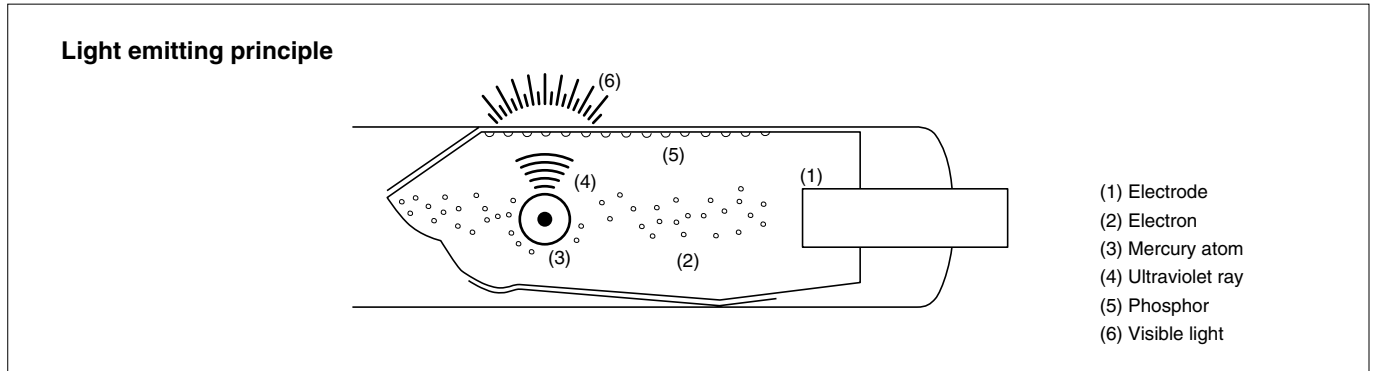

●Emission wavelength of invisible light

● The CCFL always emits UV rays (313,365 nm) in addition to visible light. See Comparison of UV Emissions on page 8. Note that UV emissions adversely affect the backlight components (reflector, light guide, etc.). See Chapter 6, “Fall of Luminance of CCFL and System,” page 15, for further details.

● The CCFL emits infrared rays (912 nm) in the initial lighting period in addition to visible light. The IR wavelength is almost the same as the remote controller wavelength, possibly causing malfunction of the remote controller. This is particularly evident in the low temperature start-up. Contact our Engineering Dept for effective countermeasures.

●Ambient Temperature (Lamp Surface Temp.) Characteristics

● As mercury vapor pressure is largely depended on the ambient temperature (lamp surface temperature), the fluorescent lamp has its ambient temperature (lamp surface temperature) characteristics.

Ambient temperature (surface temperature) low:

Emission efficiency becomes low because of low excitation caused by shortage of mercury vapor pressure.

Ambient temperature (surface temperature) high:

Emission efficiency becomes low because radiated ultraviolet ray is reabsorbed by outer mercury.

In general, the thinner lamp, makes the re-absorption ratio lower, therefore the optimal temperature becomes higher.

● If the heat dissipation state of a system is bad, lamp surface temperature will become higher than the optimal value, and luminance will be lowered. Cautions are required, when driving with large current, or when using many lamps together.

* Although luminance can be increased by lowering gas pressure, even when the heat dissipation state is not good, it will result in shorter life.

● If the heat dissipation state of a system is too good, lamp wall

temperature will become lower than the optimal value, and luminance will fall. Cautions are especially required, when lamp is thin or the drive current is low.

* Regarding the luminance fall under a good heat dissipation state, although the increase of luminance can be achieved by increasing the gas pressure, it will result in the increase of the lamp electric power.

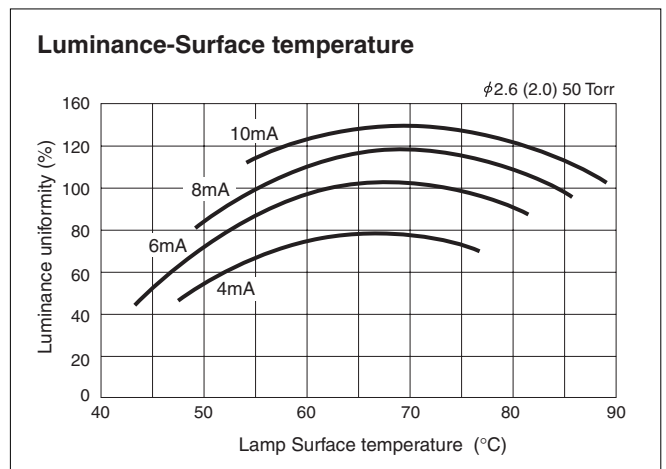

●Mercury Vapor Pressure and Volume

Mercury vapor pressure and volume, depended on ambient temperature, have the characteristics shown in the figure below.

Mercury vapor pressure is depended on ambient temperature, and mercury vapor volume is depended on ambient temperature and

lamp volume. Lamp surface temperature at lighting is 40 to 90°C depending on the lamp current. Amount of mercury actually required to vaporize to light the lamp is about a few μg.

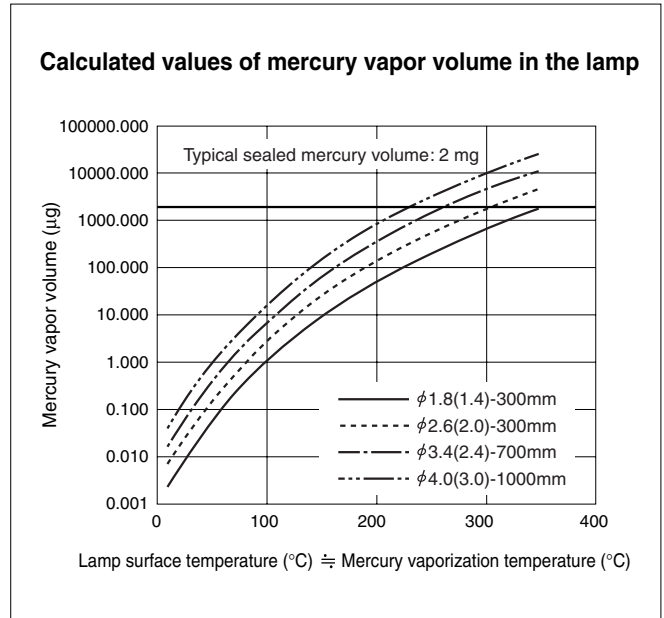
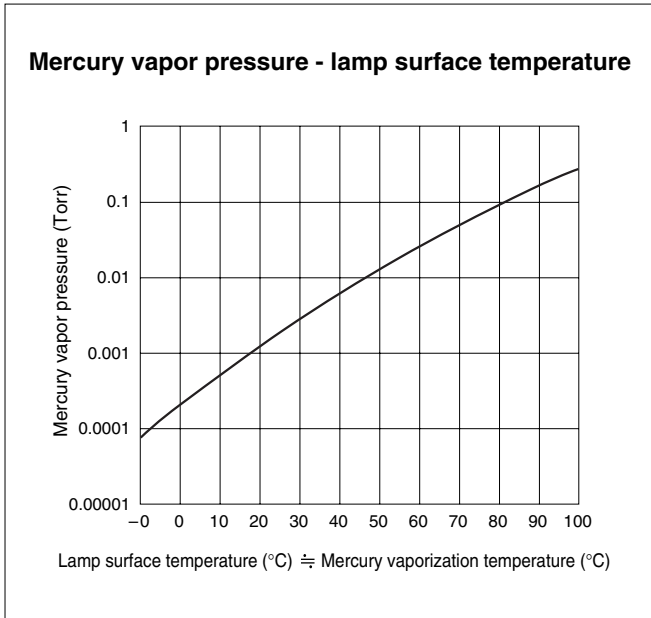

●Distribution of lamp surface temperature and mercury

With Sanken CCFLs except those for TV sets, a nearly equal volume of mercury is intentionally placed on both ends of the lamp near the electrode (outside the effective emission area). This is to increase lamp life (low temperature life in particular).

At lighting, as temperature inside the lamp rises, mercury is vaporized to high pressure and diffused.

At lights-out, the evaporated mercury returns to liquid mercury and is adhered inside the lamp. Because of this, mercury near the electrode gradually (taking long time) moves to the effective lighting area, but the volume of mercury thus moved is not so significant as to cause the decrease of back-light luminance.

When the lamp surface temperature distribution is inappropriate, however, mercury is gathered to the coldest area, and it will shorten the life of the lamp. For details, see Section 4-2, "Defects Caused by Mercury Migration due to Gradient of Lamp Surface Temperature," on page 11.

It is very difficult to judge whether the lamp wall temperature distribution in a unit state is proper or not by measuring the lamp wall temperature directly. Instead, it can be judged whether a lamp wall temperature distribution is proper or not by checking the distribution of mercury. Please contact our Engineering Dept. about the detailed check method.

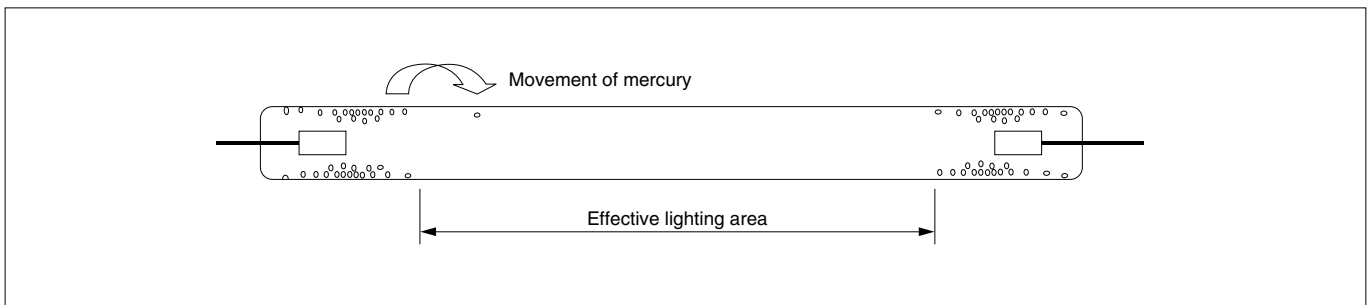

● Part Numbering System

S S 18C 3105 E4 3 85 C 290 290 0 S

Lamp shape
S: Straight
U: U shape

Specifications
S: Standard
V: UV Cut Glass

Diameter and thickness of lamp
Diameter Thickness of lamp
18: ϕ 1.8 A: 0.10 F: 0.35
 B: 0.15 G: 0.40
 C: 0.20 H: 0.45
 D: 0.25 J: 0.50
 E: 0.30

Lamp length
3105: 310.5mm
10100: 1010.0mm
The length of the U-shape lamp is the bending length.

Measuring equipment
Non: Measured value of BM-7
S: Measured value of SR-3

Lamp assy type
0: Without harness
□: With harness

Chromaticity y (Sanken value)
290: 0.290

Chromaticity x (Sanken value)
290: 0.290

Phosphor	red			green			blue		
A	611nm (Y20)			544nm (LAP)			450nm (SCA)		
B	611nm (Y20)			544nm (LAP)			450nm (BAM)		
C	611nm (Y20)			544nm (LAP)			450nm (New BAM)		
D	611nm (Y20)			544nm (LAP)			450nm (New BAM: coat)		
E	611nm (Y20)			515nm (BAM)			450nm (New BAM: coat)		
F	620nm (YPV)			515nm (BAM)			450nm (New BAM: coat)		
G	658nm (MGO) + 611nm (Y20)			544nm (LAP)			450nm (New BAM: coat)		

Ar ratio
3: 3%
5: 5%
A: 10%

Electrode (type in alphabet, length in numeral)
Electrode type Electrode length
E: Niobium cup electrode 4: 4mm
N: Nickel cup electrode 6: 6mm
 8: 8mm

Gas pressure (in numeral and alphabet)
When the Torr value has two digits, the said value is indicated.
When the Torr value has three digits, the values are as described below.
1Torr = 133kPa
A0: 100Torr D0: 130Torr G0: 160Torr K0: 190Torr
B0: 110Torr E0: 140Torr H0: 170Torr L0: 200Torr
C0: 120Torr F0: 150Torr J0: 180Torr

The above data are the result of measurement under the following condition: straight lamp, standard specifications, 1.8mm diameter, 0.2 mm thickness, 310.5 mm lamp length, Nb4mm electrode, and 3% Ar ratio, Gas pressure 85 Torr, new BAM Blue phosphor, chromaticity x=0.290, y=0.290, without harness, and measured by SR-3

● Outline and Schematic Drawings

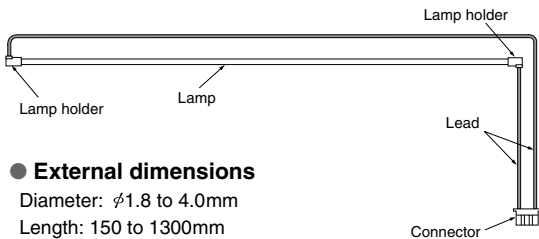

● External dimensions

Diameter: ϕ 1.8 to 4.0mm
Length: 150 to 1300mm

The product is manufactured with the above combination.
For lamp length other than the above, please consult with us.

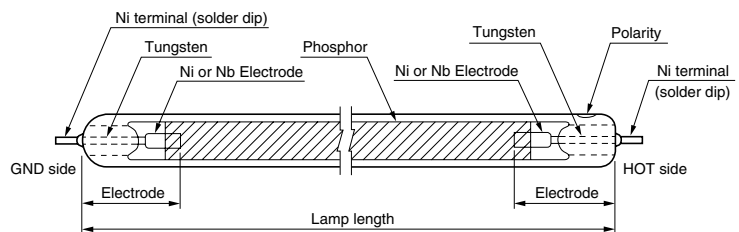

● Outer lead:

For an outer lead, the ϕ 0.8 nickel (Ni) terminal is pre-soldered. The terminal length is normally 1.5 to 2 mm, but desired length is available.

It is to be noted that the nickel terminal cannot be bent like a

Jumet wire.

For soldering, it is recommended that the core of the lead is formed in ring shape as shown in the drawing and this ring is inserted into the nickel terminal.

Example of lead connection

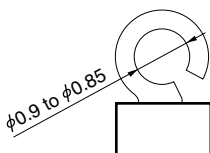

Example of soldering

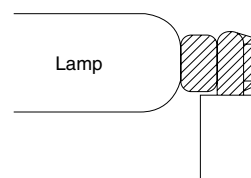

● Characteristics Diagrams

Lamp surface luminance - lamp diameter
(25°C, Ni-cup electrode)

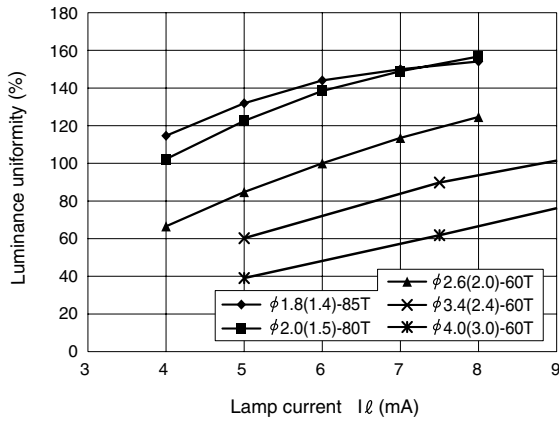

Lamp voltage - Lamp current
(319 mm lamp)

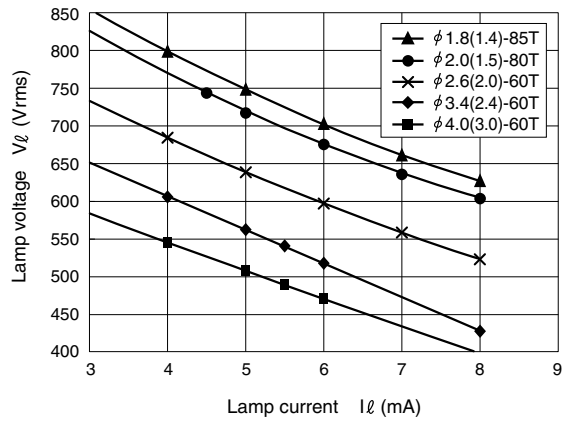

Efficiency - lamp diameter
(25°C, Ni-cup electrode)

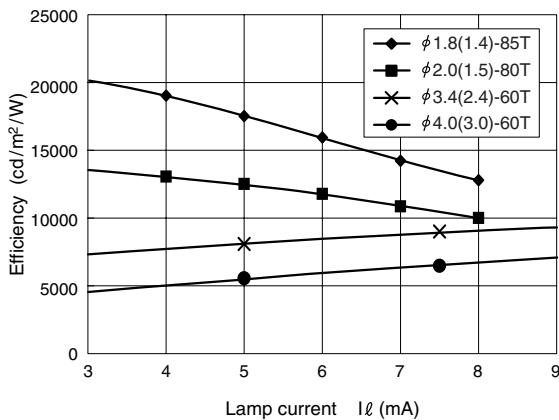

Lamp voltage - Lamp length
(Lamp current 6 mA, 25°C)

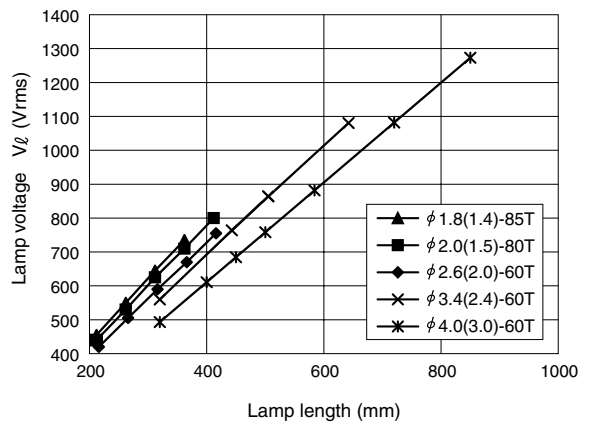

Time to become bright

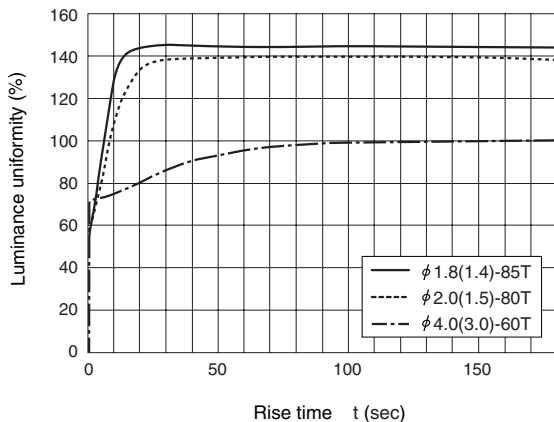

Lamp length - Lighting start voltage
(25°C)

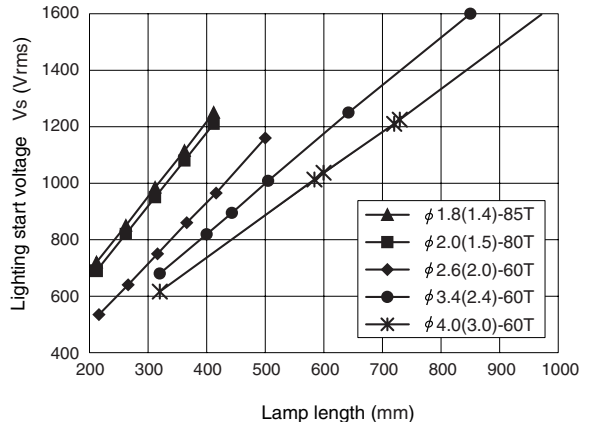

Lamp length - Lighting start voltage
(0°C)

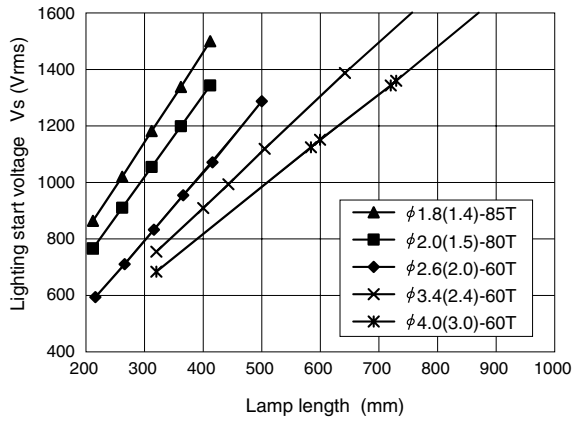

Gas pressure - Luminance
(φ2.6, 25°C)

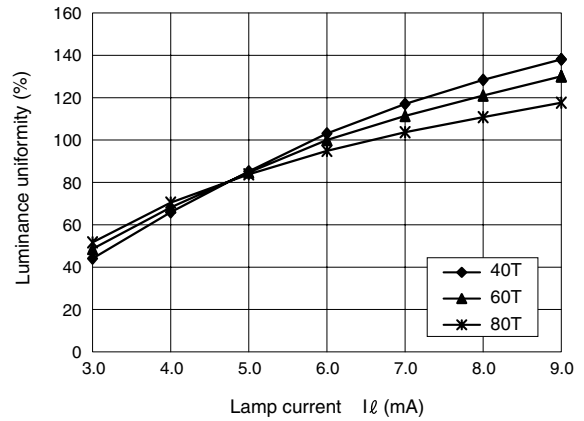

Lamp voltage - Gas pressure
(315 mm lamp, lamp current 6 mA, 25°C)

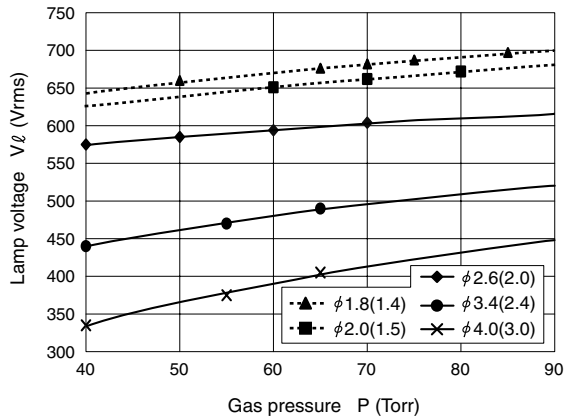

Ambient temp. - Lighting start voltage
(lamp length: 319 mm)

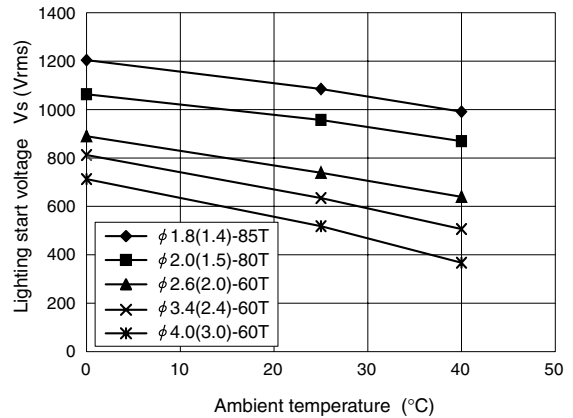

Lighting start voltage - Gas pressure
(315 mm lamp, lamp current 6 mA, 25°C)

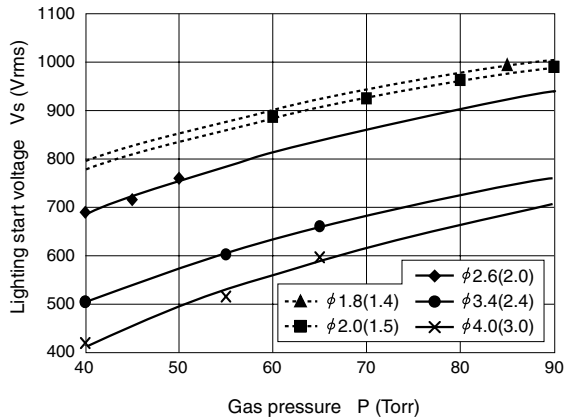

Total luminous flux - Lamp current
(Ta = 25°C, lamp length: 315 mm)

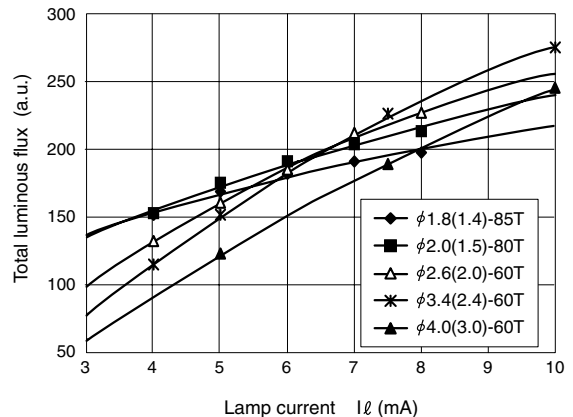

Total luminous flux - Lamp power
($T_a=25^\circ\text{C}$, lamp length: 315 mm)

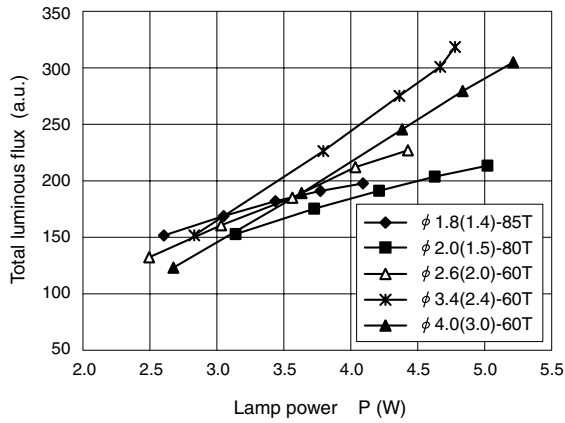

Ambient temp. - Life coefficient

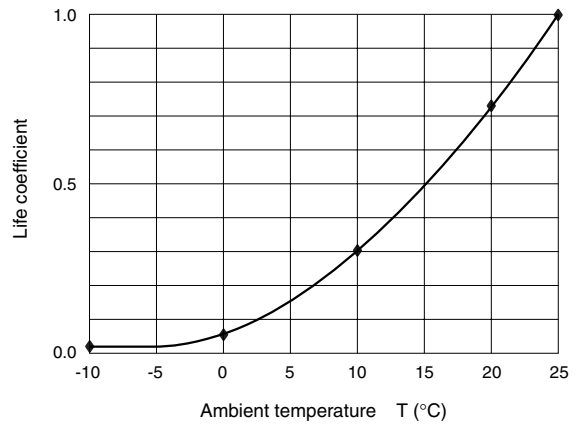

Comparison of UV emissions (ϕ 4.0 (3.0), lamp current 5.0 mA)

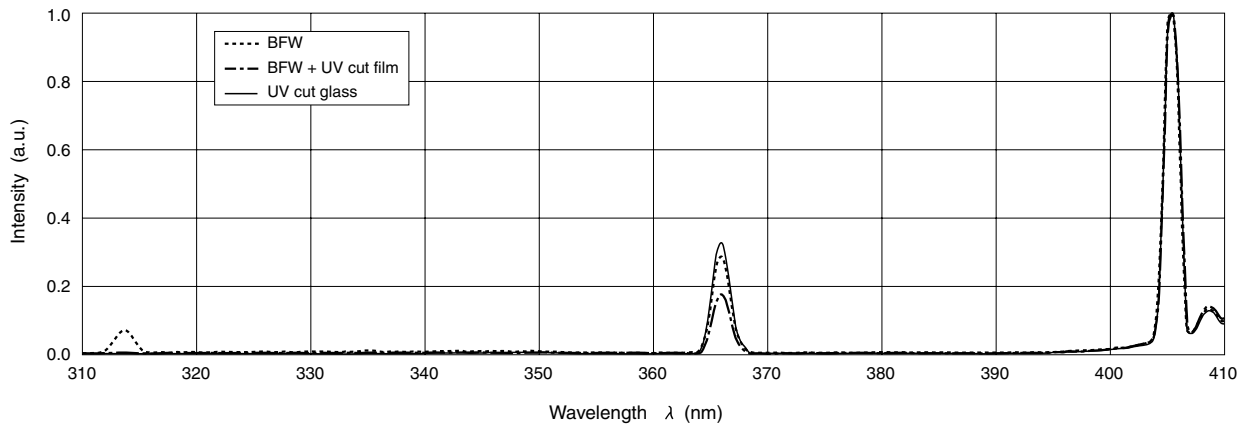

CCFL illuminant spectrum

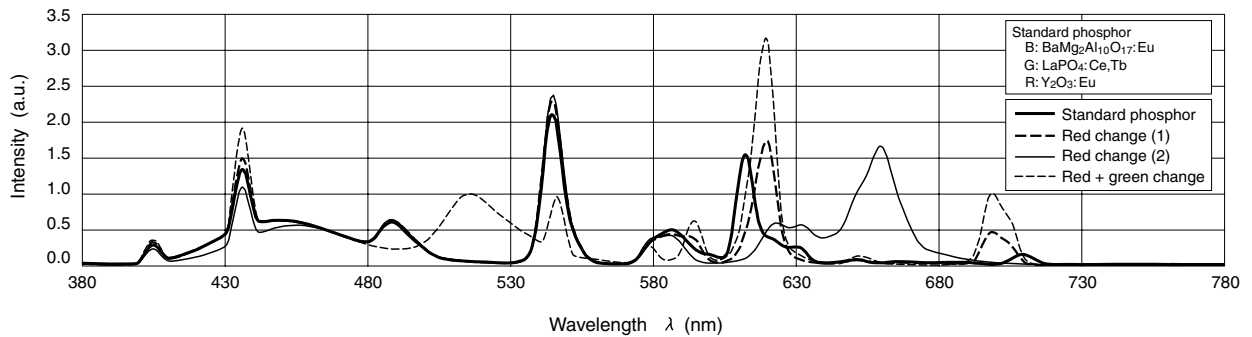

Life

1 List of Product Life

* Life of standard phosphor

● CCFLs for Notebook PCs

		$\phi 1.8 (1.4)$, electrode length: 6 mm (Ni)/4 mm (Nb)					
		Standard Ar ratio: 5% 10.0kPa (75 Torr)		Standard Ar ratio: 5% 10.6kPa (80 Torr)		Standard Ar ratio: 5% 11.3kPa (85 Torr)	
Electrode		Ni	Nb	Ni	Nb	Ni	Nb
Lamp current		min / typ	min / typ	min / typ	min / typ	min / typ	min / typ
3mA		30,000 / 40,000	27,000 / 32,000	30,000 / 40,000	30,000 / 40,000	30,000 / 40,000	30,000 / 40,000
4mA		28,000 / 36,000	22,000 / 27,000	30,000 / 35,000	25,000 / 32,000	30,000 / 37,000	28,000 / 36,000
5mA		22,000 / 28,000	17,000 / 22,000	25,000 / 30,000	20,000 / 25,000	27,000 / 32,000	22,000 / 28,000
6mA		17,000 / 20,000	12,000 / 16,000	20,000 / 25,000	15,000 / 18,000	22,000 / 27,000	17,000 / 20,000
7mA		12,000 / 15,000	7,000 / 11,000	15,000 / 20,000	10,000 / 13,000	17,000 / 22,000	12,000 / 15,000

● CCFLs for Notebook PCs

		$\phi 2.0 (1.5)$, electrode length: 6 mm (Ni)/4 mm (Nb)					
		Standard Ar ratio: 5% 9.3kPa (70 Torr)		Standard Ar ratio: 5% 10.0kPa (75 Torr)		Standard Ar ratio: 5% 10.6kPa (80 Torr)	
Electrode		Ni	Nb	Ni	Nb	Ni	Nb
Lamp current		min / typ	min / typ	min / typ	min / typ	min / typ	min / typ
3mA		30,000 / 40,000	30,000 / 40,000	30,000 / 40,000	30,000 / 40,000	30,000 / 40,000	30,000 / 40,000
4mA		30,000 / 35,000	25,000 / 30,000	30,000 / 37,000	27,000 / 32,000	30,000 / 40,000	30,000 / 40,000
5mA		25,000 / 30,000	20,000 / 25,000	27,000 / 32,000	22,000 / 27,000	30,000 / 35,000	25,000 / 30,000
6mA		20,000 / 25,000	15,000 / 20,000	22,000 / 27,000	17,000 / 22,000	25,000 / 30,000	20,000 / 25,000
7mA		15,000 / 20,000	10,000 / 15,000	17,000 / 22,000	12,000 / 17,000	20,000 / 25,000	15,000 / 20,000

● CCFLs for monitors

		$\phi 2.2 (1.8)$, electrode length: 6 mm					
		Standard Ar ratio: 5% 8.0kPa (60 Torr)		Standard Ar ratio: 5% 9.3kPa (70 Torr)		Standard Ar ratio: 5% 10.6kPa (80 Torr)	
Electrode		Ni	Nb	Ni	Nb	Ni	Nb
Lamp current		min / typ	min / typ	min / typ	min / typ	min / typ	min / typ
3mA		50,000 / 65,000	50,000 / 70,000	50,000 / 70,000	50,000 / 70,000	50,000 / 70,000	50,000 / 70,000
4mA		50,000 / 60,000	50,000 / 65,000	50,000 / 65,000	50,000 / 70,000	50,000 / 70,000	50,000 / 70,000
5mA		45,000 / 55,000	50,000 / 60,000	50,000 / 60,000	50,000 / 65,000	50,000 / 65,000	50,000 / 70,000
6mA		40,000 / 50,000	45,000 / 55,000	45,000 / 55,000	50,000 / 60,000	50,000 / 60,000	50,000 / 70,000
7mA		35,000 / 45,000	40,000 / 50,000	40,000 / 50,000	50,000 / 55,000	45,000 / 55,000	50,000 / 65,000
8mA		25,000 / 35,000	30,000 / 40,000	35,000 / 45,000	40,000 / 50,000	40,000 / 50,000	50,000 / 60,000

● CCFLs for TV and monitors

		$\phi 2.4 (2.0)$, $\phi 2.6 (2.0)$, $\phi 3.0 (2.0)$, electrode length: 8 mm					
		Standard Ar ratio: 5% 6.7kPa (50 Torr)		Standard Ar ratio: 3% 8.0kPa (60 Torr)		Standard Ar ratio: 3% 9.3kPa (70 Torr)	
Electrode		Ni	Nb	Ni	Nb	Ni	Nb
Lamp current		min / typ	min / typ	min / typ	min / typ	min / typ	min / typ
3mA		50,000 / 70,000	50,000 / 70,000	50,000 / 70,000	50,000 / 70,000	50,000 / 70,000	50,000 / 70,000
4mA		50,000 / 70,000	50,000 / 70,000	50,000 / 70,000	50,000 / 70,000	50,000 / 70,000	50,000 / 70,000
5mA		50,000 / 60,000	50,000 / 70,000	50,000 / 70,000	50,000 / 70,000	50,000 / 70,000	50,000 / 70,000
6mA		40,000 / 60,000	50,000 / 70,000	50,000 / 60,000	50,000 / 70,000	50,000 / 70,000	50,000 / 70,000
7mA		30,000 / 50,000	50,000 / 70,000	40,000 / 60,000	50,000 / 70,000	50,000 / 60,000	50,000 / 70,000
8mA		25,000 / 40,000	40,000 / 55,000	30,000 / 50,000	50,000 / 70,000	40,000 / 60,000	50,000 / 70,000

● CCFLs for TV

		$\phi 3.4 (2.4)$, electrode length: 8 mm				$\phi 4.0 (3.0)$, electrode length: 8 mm	
		Standard Ar ratio: 5% 6.7kPa (50 Torr)		Standard Ar ratio: 5% 8.0kPa (60 Torr)		Standard Ar ratio: 5% 8.0kPa (60 Torr)	
Electrode		Ni	Nb	Ni	Nb	Ni	Nb
Lamp current		min / typ	min / typ	min / typ	min / typ	min / typ	min / typ
4mA		60,000 / 70,000	70,000 / 80,000	60,000 / 70,000	70,000 / 80,000	60,000 / 80,000	70,000 / 90,000
5mA		55,000 / 65,000	65,000 / 75,000	60,000 / 70,000	70,000 / 80,000	60,000 / 80,000	70,000 / 90,000
6mA		50,000 / 60,000	60,000 / 70,000	55,000 / 65,000	65,000 / 75,000	60,000 / 75,000	70,000 / 85,000
7mA		45,000 / 55,000	55,000 / 65,000	50,000 / 60,000	60,000 / 70,000	55,000 / 70,000	65,000 / 80,000

2 Definition of Life

The life of a CCFL is defined by one of the following events:

[Definition of End of Life of CCFL]

- (1) Luminance falls to 50% or less of the initial value.
- (2) Normal lighting is no more available. (*)
- (3) Lamp voltage or Lighting start voltage exceeds the specified value.

(*) Flickering, pink lighting, no lighting, etc.

Note: Flickering of a CCFL is due to the presence of impure gases residual in the lamp or having entered the lamp from the environment. Flickering may disappear when turning the lamp off and then on but recurs when the lamp is continuously lit for an extended period of time. The amount of impure gases decreases because they are captured in the spatter as the lamp is repeatedly lit and extinguished.

Flickering due to residual impure gases:

Occurring in the initial lighting period (initial period following production), flickering of this type is likely to occur in a high ambient temperature atmosphere.

Flickering due to impure gases entering the lamp from outside:

Flickering of this type is called as slow leak, due to impure gases entering the lamp when the lamp is stored for a long period of time. Flickering decreases temporarily, when the lamp is repeatedly lit and extinguished but recurs some time after. Ingress of a large quantity of impure gases results in non-lighting of the lamp.

The life of a CCFL ends mainly due to electrode spattering and phosphor deterioration.

The lamp diameter is closely related to these causes of life expiration.

- $\phi 1.8$ (1.4) thru $\phi 2.6$ (2.0) for Notebook PCs and monitors;
- $\phi 3.0$ (2.0) for TV

Electrode spattering is the major determinant of life because of the large current density relative to the discharge area of the electrode.

- $\phi 3.0$ (2.4), $\phi 3.4$ (2.4), $\phi 4.0$ (3.0) for TV

Decreased luminance maintenance ratio due to phosphor deterioration is the major determinant of life because of the small current density relative to the discharge area of the electrode and low electrode spattering.

2-1 Life Ending Mode of Electrode Spattering

Electrode spattering occurs due to the depletion of effective mercury and sealing gas (Fig. 1).

[Depletion of Effective Mercury]

- Radiation from mercury lessens and the lamp turns dark when mercury in the lamp (effective mercury) is captured in the spatter and depleted (low luminance \rightarrow no lighting).

[Depletion of Sealing Gas]

- The electrical characteristics deviate to cause pink lighting, when the sealing gas in the lamp is captured in the spatter and depleted.

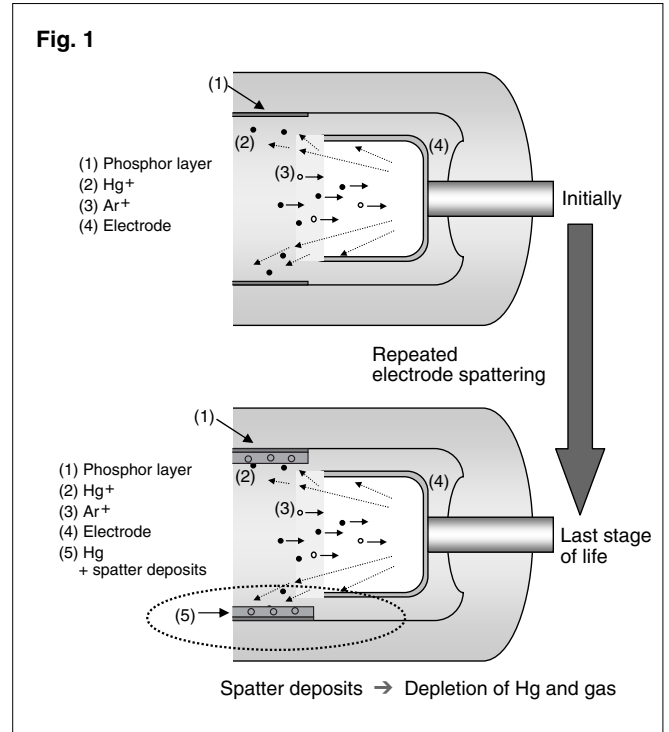

2-2 Life Ending Mode due to Deteriorated

Phosphor deteriorates due to:

- Mercury adsorption:
Emission efficiency falls due to the adsorption of mercury on phosphor.
- Ion bombardment:
Emission efficiency falls due to structural deterioration of the phosphor surface layer.

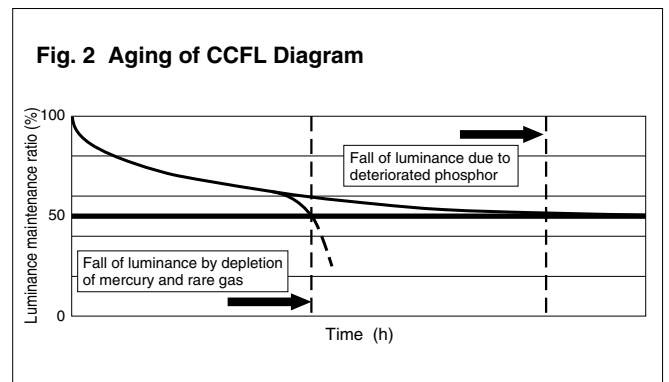

3 Precautions at End of Lamp Life

When running a CCFL continuously after its life expiry date, the spatter deposits grow in size and may connect to the electrode. The spatter deposits, once connected to the electrode, become red-hot and increase the glass surface temperature to above 300°C (for certain areas, typically, within about 5 mm from the tip of a cup electrode). Gas consumption is accelerated to increase both the lighting start voltage and lamp voltage.

Note that the following failures can occur:

- Electrode temperature and lamp current increase due to gas consumption

Increased gas consumption increases ion bombardment to the

electrode and thus raises the electrode temperature. Increased gas consumption also distorts the lighting waveform. Usually, lamp current is fed back by an inverter to stabilize the waveform. The average of the lamp current is generally detected and if the distortion of the lighting waveform becomes large, the difference between effective and average current increases with the result that the current value is increased to be more than the detected current, thereby increasing the electrode temperature.

The effect of increased electrode temperature on the adjacent components should be considered in the system design.

4 Examples of Lamp Failure

Lamp failures include pink lighting, uneven mercury migration due to improper gradient of the lamp surface temperature, and irregular lighting waveform and optical waveform.

4-1 Pink Lighting

Pink lighting is classified into three types as follows:

Mode	Phenomena	Features	Causes
a	Entire pink lighting	The symptom continues.	Mercury depletion
b	Initial partial pink lighting	Disappears in a few minutes.	Uneven Mercury migration
c	Initial full pink lighting	Disappears shortly.	Ar gas depletion

a. Entire pink lighting

[Cause] Mercury depletion (at the end of life)

The lamp lights in pink over its entire length for many hours when mercury is depleted as a result of excessive spatter deposits as mentioned above.

b. Initial partial pink lighting

[Cause] Uneven mercury migration

When the uneven mercury migration occurs, mercury vapor is low in some specific areas and emissions (in pink) from Ne-Ar discharge only are visible. In a few minutes, as the lamp temperature rises, the mercury vapor increases to provide white luminescence from mercury and dispel pink lighting.

c. Initial entire pink lighting

[Cause] Ar gas depletion

Normally, Ar gas stimulates mercury to discharge UV rays and phosphor is excited to emit radiations. Discharge of UV rays from mercury is delayed, when Ar gas is low. As a result, the entire lamp emits radiations (pink) by only Ne discharge for about several tens of seconds before luminance stabilizes.

4-2 Failures Mode due to Uneven Mercury Migration caused by Presence of Gradient in Lamp Surface Temperature

The surface temperature of a CCFL is nearly uniform over the emitting section (flat section) while it is relatively high near the electrodes on both sides (Fig. 3). (The temperature is slightly

different between both electrodes; the ground side is generally higher than the other.)

On lighting the lamp, mercury present near the electrodes migrates uniformly over the entire flat section. Mercury near the ground-side electrode will never migrate to the hot-side electrode area.

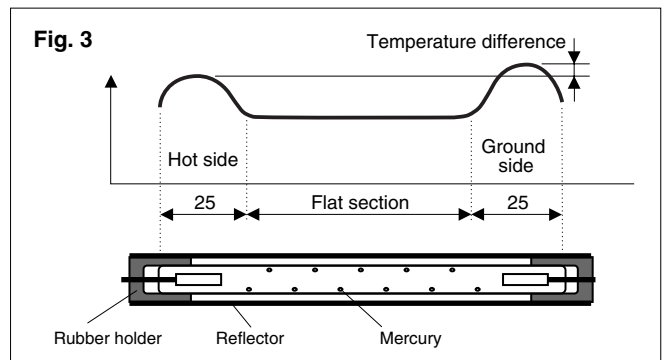

(1) In the case that temperature gradient exists on the flat section between electrodes (Fig. 4)

Mercury gathers on the coldest area (migration) and is depleted on the opposite side if the lamp surface temperature is not uniform over the entire flat section between electrodes. Mercury vapor is low and a dark area appears when mercury is significantly depleted. Even if a dark area does not appear, lack of mercury vapor increases spattering at the electrode and shortens the life of the lamp.

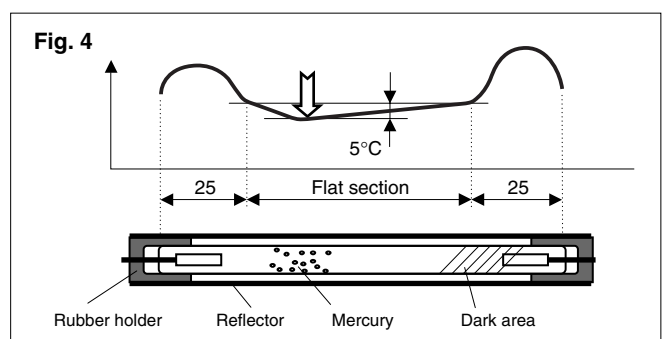

(2) In the case that the lamp end is the coldest area (Fig. 5) Mercury gathers on the lamp ends, when the temperature of the lamp ends is lower than that of the flat section. Mercury vapor decreases and the dark portion appears at the center of the lamp.

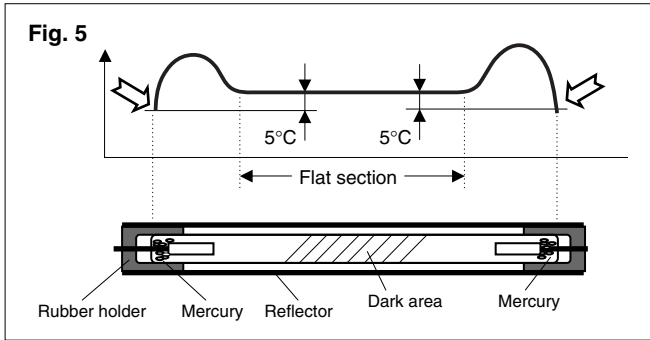

4-3 Failure Mode due to Irregular Lighting Waveform

Excessively distorted lighting waveforms lead to uneven mercury migration or gas consumption. Sanken defines the lighting waveform by the level of imbalance and crest factor. See Chapter 5, “Notes on Lamp Lighting Waveform.” Lamp life is prolonged by improving the imbalance and crest factor.

4-4 Failure Mode due to Irregular Optical Waveform

Mercury vapor pressure falls and the lamp lights unstably affecting the luminescence when the lamp surface temperature falls. Figure 6 shows a typical failure. The optical waveform fluctuates to generate flickers even though the lighting waveform and the lamp voltage are stable.

Fig. 6 Optical and Lighting Waveforms (Lamp Current and Lamp Voltage Waveforms)

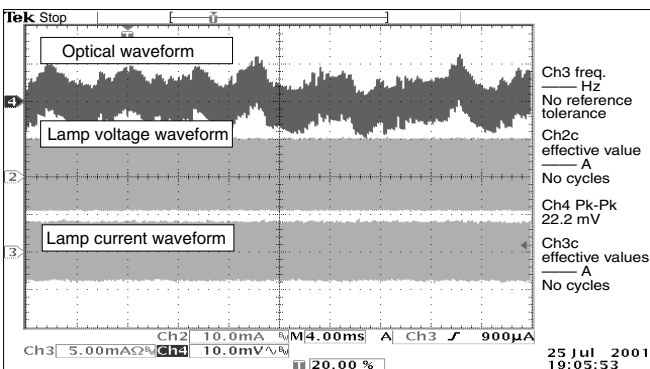
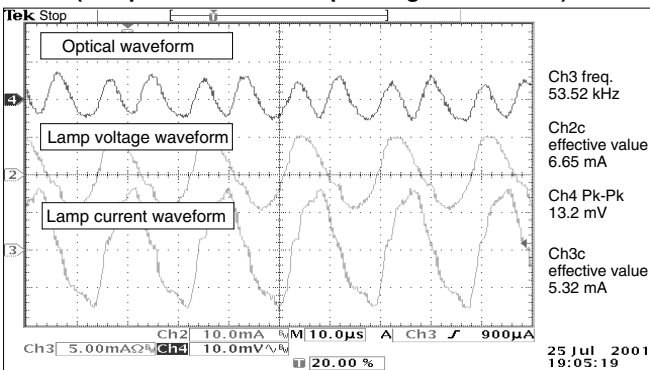

The dimming range changes because the lamp surface temperature varies with heat dissipation of the system and the lighting waveform of the inverter. Before setting the dimming range, check the optical waveform that appears under the operating conditions of the lowest lamp surface temperature (low temperature, minimum dimming) using the actual system.

Lamp surface temperature decreases due to the reasons mentioned below. The customer is requested to consider this point in the system design.

< Factors of Lamp Surface Temperature Fall >

Item	Factor of Lamp Surface Temperature Fall	Remarks
Ambient temp	Low	Fall of ambient temp → Rise of lamp voltage
Lamp dia.	Large	The smaller the lamp dia., the more sensitive the lamp is to ambient temp.
Gas pressure	Low	Caution: Luminance may fall if gas pressure is increased.
Reflector cap	Small	Lamp surface temperature will fall when the system’s heat dissipation is appropriate.
Dimming	Large burst dimming	Compared to current dimming at the same lamp current (effective value).
Soft start time	*1 Long	Compared at the fixed peak current, duty and burst frequency.
Burst frequency	*2 High	Compared at the fixed peak current, duty and soft start time.
Lighting frequency	Low	High lighting frequency → Large leakage → Beware of possible deterioration of lighting waveform.

*1 & 2: Take into consideration the following points when setting the soft start time and burst frequency:

Soft start time:

Should be as short as possible without overshoots of lamp current. For reference: 100 to 200 μs max.

Burst frequency:

The lamp turns off before the rated current flows, if the frequency is too high. Use a frequency not to turn off till the rated current flows.

Reference values: 150 to 500 Hz.

4-5 Life Factor Analysis of Defective Lamps

Defective lamps are analyzed at Sanken for both CCFL factors and system factors considering the following points:

[Items for Analysis]

(1) Electrical and Optical Characteristics: Lighting start voltage, lamp voltage, luminance and chromaticity
When the lamp is ready to be lit, the lighting start voltage and lamp voltage are measured in the NF circuit. The gas depletion

is generally accelerated at the end of life to raise the lighting start voltage and the lamp voltage.

Ar depletion is accelerated if the lighting waveform is irregular (see Chapter 5, “Notes on Lamp Lighting Waveform”). The Ar ratio is correctly measured by a gas analysis (destructive test) but Ar depletion can roughly be estimated by checking the lighting condition.

Sanken has no Ar gas blend process, since it procures blended units. The Ar gas ratio does not decrease in our manufacturing process.

(2) Mercury Volume: Measurement of Effective and Ineffective Mercury Volume

Low mercury volume at manufacturing is a cause of short life of the lamp. It can be determined whether the problem is attributable to manufacturing process or not by measuring the mercury volume (both effective and ineffective) of the defective lamp.

(3) Mercury Distribution: Mercury distribution is measured using X-rays, etc.

The actual unit is required to determine if uneven mercury migration is due to a general manufacturing issue or a specific issue of the application. Sanken requests the customer to return the defective lamp as mounted on the actual product.

(4) Spattering: Wearing of the electrode and spattering conditions are measured using X-rays, etc.

Life factors are estimated by observing the spattering conditions. If gas pressure is low at manufacturing, spattering is accelerated to shorten the life of the lamp. It is difficult to determine whether the problem is attributable to manufacturing process or application by simply checking the defective lamp alone. Sanken requests an analysis at the actual product (PC).

Sanken estimates the cause of the defects by the above analyses. To estimate more accurately, we need the CCFL as it mounted in the system. The modern systems (actual units) are increasingly thin and use magnesium housing, thereby presenting severe environments for CCFLs. Analysis of lamps in these new environments is becoming increasingly important.

5 Notes on Lamp Lighting Waveform

5-1 Lighting Waveform

Heavily distorted lighting waveforms lead to uneven mercury migration and gas consumption. Sanken defines the distortion of lighting waveforms by the level of imbalance and crest factor. Sanken recommends the application within $\pm 10\%$ allowance for the level of imbalance and $\sqrt{2} \pm 15\%$ for the crest factor.

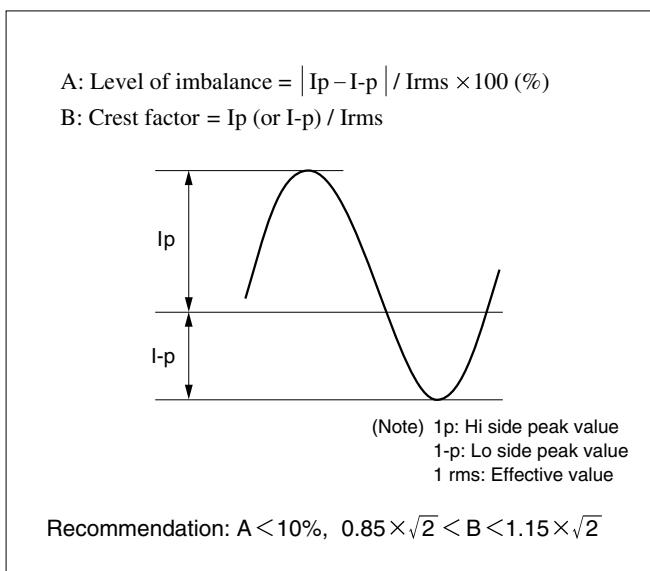

When the lighting waveform is asymmetrical, the Hg^+ ions in the discharge space are strongly attracted to either of the two electrodes, resulting in uneven mercury migration.

For a high crest factor, Ne and Ar ions (Ar ions in particular) impinge on the electrode and are depleted (clean-up). This event occurs particularly in a low temperature environment.

Lighting waveforms are more distorted, when the CCFL is used in an LCD module than used separately. Please confirm this phenomenon on your actual machine. The Sanken inverters are designed in consideration of this phenomenon .

< Method for Improving Imbalance and Crest Factor >

The following methods are available for improving imbalance and crest factor:

- [Methods for improving imbalance and crest factor]**
- (1) Inverter:
 Perform the following inverter-side changes:
 Lamp power, driving frequency, capacitance of ballast capacitor and of resonance capacitor
- (2) Unit:
 Increase the distance between lamp surface and reflector to the maximum extent.
- (3) Lamp:
 (1) Increase the Ar gas ratio
 (2) Increase gas pressure
 (3) Use a lamp of a larger diameter
 Note that luminance may fall, when you select the lamp-related measures.

5-2 Lighting Frequency

Refer to the following table for the recommended lighting frequencies. When the lamp diameter is smaller, the higher lighting frequency should be set. When the lighting frequency is too high, it is likely to increase leakage and to distort the waveform. When the lighting frequency is too low, lighting waveforms are easily distorted to make lighting unstable.

< Recommended lighting frequency >

Lamp I.D.	φ1.4	φ1.5	φ1.8	φ2.0	φ2.4	φ3.0
min	45kHz	45kHz	40kHz	35kHz	30kHz	30kHz
typ	60kHz	55kHz	50kHz	50kHz	45kHz	45kHz

Refer to the lighting frequency-related data.

Fig. 7 Luminance - lamp current characteristics

Lamp: φ2.0 (1.5) × 292mm Ar3% - 9.31kPa (70Torr)
INV: NF circuit (AS-114A), C_B=22pF, T_a=25°C

CCFL only

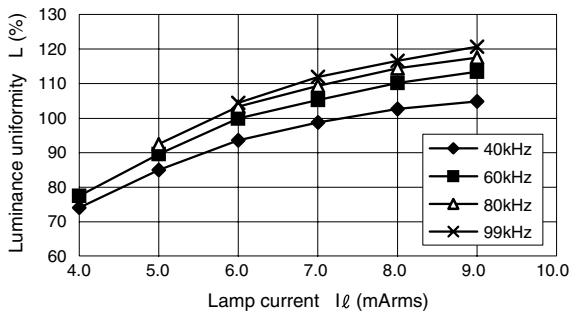

Fig. 8 Luminance/emission efficiency - lighting frequency

CCFL only

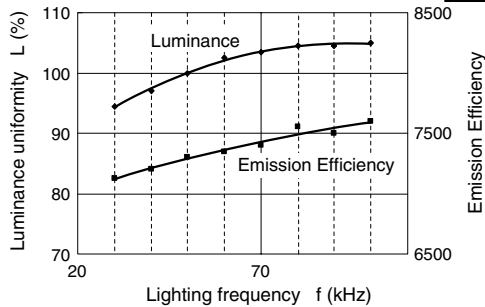

Fig. 9 Luminance/leakage current - lighting frequency

LCD backlight system

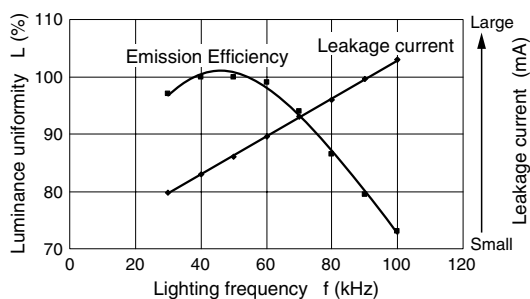

Fig. 10 Lamp voltage - lighting frequency characteristics

CCFL only

Lamp: φ1.8 (1.4) × 254mm, Ar5% - 85Torr, Nb4
INV: NF circuit (AS-114A), C_B=22pF, T_a=25°C

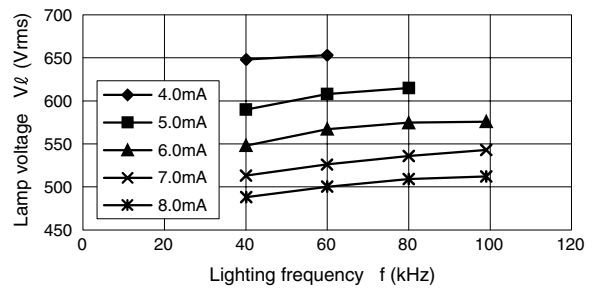

Fig. 11 Lamp voltage - lighting frequency characteristics

LCD backlight system

Lamp: φ1.8 (1.4) × 254mm, Ar5% - 85Torr, Nb4
INV: NF circuit (AS-114A), C_B=22pF, T_a=25°C

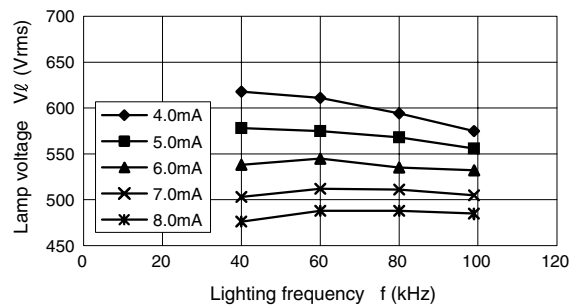
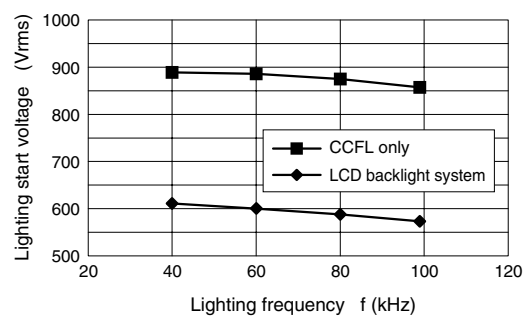

Fig. 12 Lighting start voltage - lighting frequency characteristics

CCFL only

LCD backlight system

Lamp: φ1.8 (1.4) × 254mm, Ar5% - 85Torr, Nb4
INV: NF circuit (AS-114A), C_B=22pF, T_a=25°C



[Cautions] Lamp voltage and Lighting start voltage of a CCFL used as an independent lamp are different from those of a CCFL used in a system.

Luminance of a CCFL, when used as an independent lamp, increases with increasing frequency. For a CCFL used in a system, the leakage current increases and efficiency deteriorates, when the frequency is increased.

5-3 Lighting start voltage

Lighting start voltage of a CCFL increases, as temperature becomes lower. Lighting start voltage of a CCFL used in an LCD backlight system can be higher or lower than the lighting start voltage of a CCFL used separately.

[Lighting start voltage when using a ballast capacitor]

Edge light: CCFL only > LCD backlight system

Directly below: CCFL only < LCD backlight system

[Lighting start voltage for a ballast capacitorless system]

Edge light: CCFL only > LCD backlight system

Directly below: CCFL only > LCD backlight system

When designing an inverter, confirm the lighting start voltage assuming use of the lamp in the LCD backlight system at low temperature.

5-4 Protection Function

For the design of an inverter, Sanken recommends providing a protection function in consideration of the lamp life and other factors described above. For details, contact our Engineering Dept.

6 Decreased Luminance of CCFL and System

Luminance of a system is lost faster than that of the lamp itself. This is because the backlight components (reflector, light guide, etc.) gradually deteriorate by exposure to the UV rays and heat from the lamp (Fig. 13).

The Sanken's CCFL is warranted for life as an independent lamp. The warranty does not apply to the life of the CCFL used in a system.

The Sanken's CCFL uses special glass for reducing UV emissions. CCFLs made of UV cut glass are also available. Contact our Engineering Dept for details.

Fig. 13 Results of Normal Temperature Backlight Test of 14.1-in Notebook PC (One CCFL: ϕ 2.0, lamp current 6 mA)

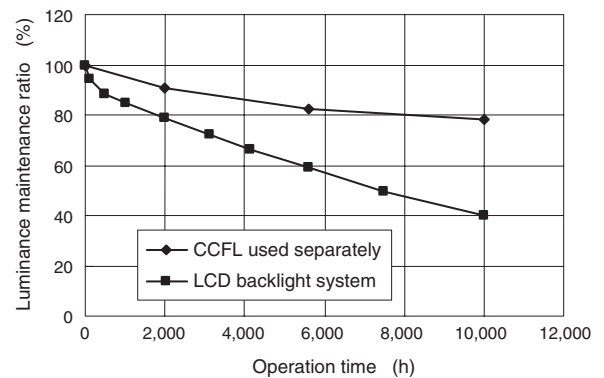

● Measurement

Specific precautions are required for measuring the CCFL, because, in addition to electrical features related to high voltage and high frequency, optical features of the very small and non-planar

(cylindrical) area peculiar to CCFLs are involved. Precautions and suggestions for the measurement of CCFLs are described below for your reference.

1 Measuring Equipment

The measuring equipment (including power supply, measuring instruments, etc.) is introduced below.

1-1 Power Supply and Electrical Measuring Instruments

1-1-1 Power Supply

A power supply generating 40 to 60 kHz frequency close to sine waves is generally used for CCFL measurement. Sanken uses a DC stabilized power supply combined with an inverter adapted to the customer specification or a specially designed integrated power supply (NF Corporation Model AS114 cold cathode discharge characteristics testing system). The output voltages of either power supply are variable and measurement is performed after confirming that there is no variation which may affect the measurement.

1-1-2 Measuring Instruments

The AC measuring instruments as well as instruments built-in in the power supply indicate the results of measurement in the effective values. The standard instruments used at Sanken are listed below for your reference.

Current measurement:

Yokogawa Electric YEW Model 2016 high-frequency AC ammeter

Voltage measurement:

NF Corporation Model AS114 cold cathode discharge characteristics test system

1-1-3 Circuitry

The measuring circuit is described below.

- (1) Figs. 14 and 15 show examples of the electrical characteristics measuring circuits used at Sanken.

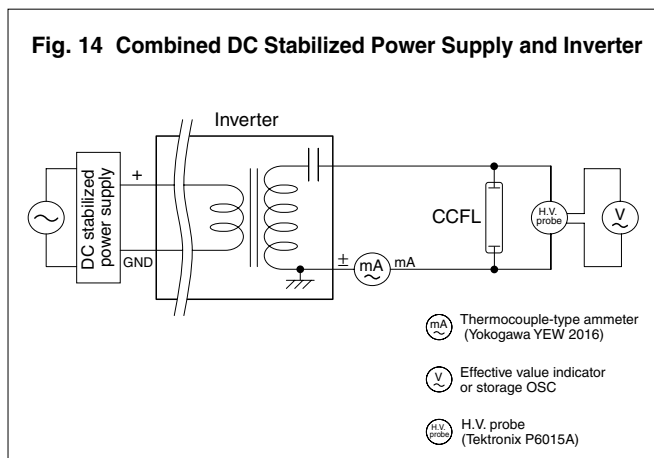
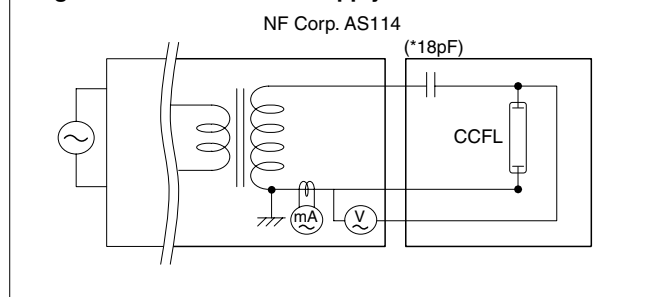

Fig. 15 Dedicated Power Supply



- (2) The circuit diagram shall indicate the manufacturer name and the type number of measuring instruments in use. When a dedicated power supply is used, the manufacturer name and the type number shall be also indicated.
- (3) Cables connecting the instruments to the lamp shall conform to the relevant standards for cables (pressure withstand, etc.). The cable length must be as short as possible to prevent leakage current generated by high frequency and high voltage.

1-2 Optical Measuring Equipment

1-2-1 Place for Measurement

The measurement shall take place at a place where the lamp surface is not affected by wind and the conductive object should not be located near the lamp to prevent leakage current. Ambient temperature of the place of measurement shall be $25 \pm 2^\circ\text{C}$, unless a particular environmental temperature is specified by the customer (lighting start voltage, etc.). The place of measurement must be free from wind and vibration that may affect measurement. The measuring system must be free from the effects of reflected radiations from nearby objects or the effects must be negligible.

1-2-2 Instruments

A spectroradiometer or a luminance colorimeter is used to measure luminance and chromaticity. The spectroradiometer is controlled by the calibration system traceable to the national standard. The luminance colorimeter is so calibrated as to reproduce the values of the master CCFL measured by the calibrated spectroradiometer.

Sanken uses the Topcon Model SR3 spectroradiometer, which is deemed as the de facto industry standard. The Topcon Model BM7 luminance colorimeter has been used in the LCD industry as the standard measuring instrument. Sanken has made a comprehensive investigation into instrumental error, accuracy and

other features of the equipment and recommends Model SR3 spectroradiometer for measuring luminance and chromaticity of CCFLs.

The accuracy of measurement is compared in the table below for your reference.

Instrument	Accuracy *1 of luminance	Accuracy *1 of chromaticity	Accuracy *2 of chromaticity
Spectroradiometer SR3	±2%	Within ±0.002	Within ±0.005
Luminance colorimeter BM7	±4%	Within ±0.002	Within ±0.03

*1: When measuring Std A Light Source

*2: For radiations equivalent to CCFL (reference only)

1-2-3 Measurement Diagram

The following conditions must be satisfied when measuring optical characteristics:

- (1) Optical characteristics shall be measured as shown in Fig. 16.
- (2) The measurement diagram shall indicate the supplier's name and the type number of the instruments in use.

- (3) The measuring diagram shall indicate the dark box, fixing method and the measuring distance.

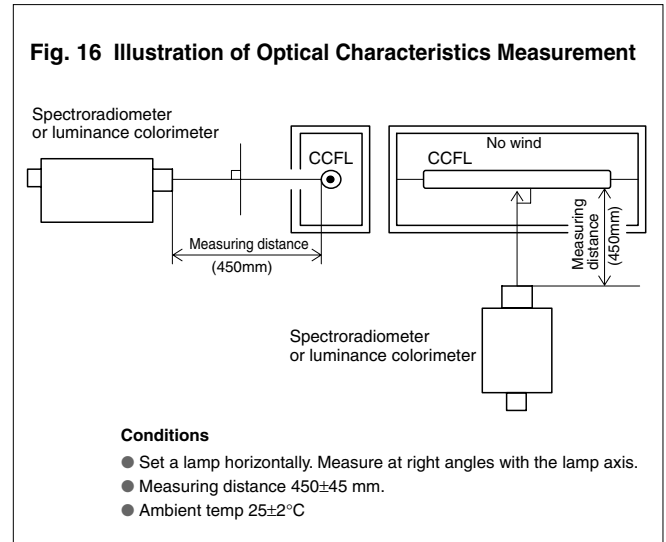

2 Measuring Method

This section describes the actual measuring methods and precautions.

2-1 Measurement of Electrical Characteristics (Lighting start voltage, and Lamp Voltage and Current)

2-1-1 Lamp Position

The lamp shall be set horizontally. Exert caution to prevent the heat of the lamp from affecting the temperature to be measured.

2-1-2 Measurement of lighting start voltage

The lamp starts discharging, as the voltage is gradually increased. Increase the voltage further until major discharge occurs. Then, measure the voltage. Since measured values may vary significantly for the reasons mentioned below, please confirm the measuring method before starting the measurement.

- Measured values are different subject to the measuring points, for example, transformer output side or lamp side (before or after the ballast capacitor). Sanken measures on the lamp side.
- Measured values are different subject to the capacitance of the ballast capacitor.
- For the ballast capacitor-less inverter, the transformer output voltage equals lamp voltage.

Sanken takes all measurements on the lamp side. The peak voltage across both ends of the lamp is measured by the NF AS114 system using its peak hold function. (See Fig. 17 V-I Characteristics Diagram.)

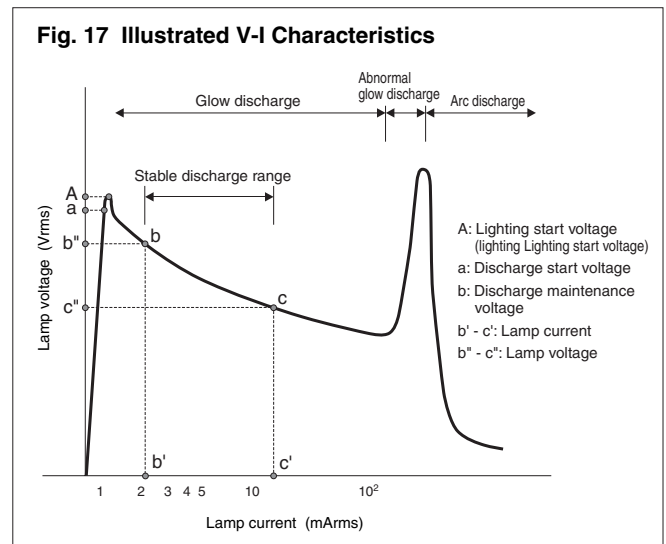

2-1-3 Setting of Lamp Current

The lamp current is set to the specified value. (The high frequency ammeter is connected to the GND side.)

2-1-4 Measurement of Lamp Voltage

After the specified lamp current is set, the stabilized lamp voltages (at both ends of the lamp) are measured. Note that the precautions stated in Section 2-1-2, "Measurement of lighting start voltage," can also apply hereto.

2-1-5 Precautions for Measurement

- (1) The high voltage probe for measuring the lamp voltage should

be of a small capacitance type as far as possible to minimize the effect of leakage current flowing to the probe on the measurement. Sanken uses the Tektronix high voltage probe Model P6015A for measuring high voltages. The measurement of absolute values with a probe is very difficult because of large changes in stray capacitance viewed from the lamp. Capacitance of the NF AS114 instrument is about 2.5 pF, or the smallest of all currently available instruments. The stable measurement is assured with minimal effects of leakage current on the measurement.

- (2) Before lighting the lamp and measuring the Lighting start voltage, ensure that the lamp surface temperature and the ambient temperature are well balanced.

2-2 Measurement of Optical Characteristics (Luminance and Chromaticity)

2-2-1 Measuring Points

The measuring point is at the center of the lamp and within the visual angle of the measuring instrument (represented by the black circle in Fig. 18) (spectroradiometer or luminance colorimeter). The measuring point is sufficiently small in relation to the internal diameter of the lamp and luminance and chromaticity should not vary, even if the position of the measuring point is changed slightly. The measuring point is on the cylindrical surface, but the surface is considered flat by sufficiently reducing the size of the measuring point (Fig. 18). The visual angle of the instrument (spectroradiometer or luminance colorimeter) is set to 0.1 degrees for measurement of the luminance and chromaticity of a CCFL.

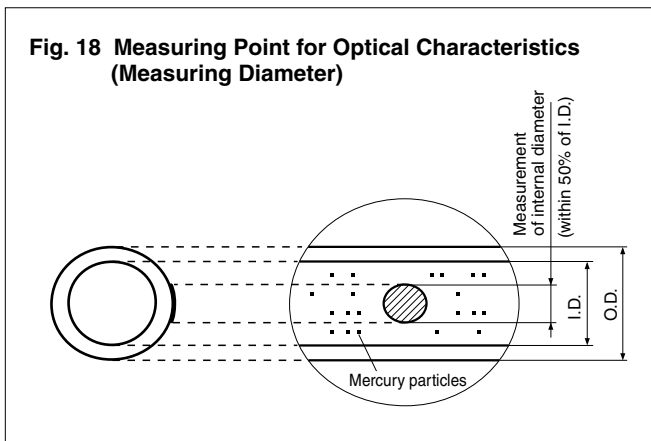

At Sanken, signals from the CCD camera installed on the SR3 finder are imaged on a monitor for checking and making necessary adjustments as required (Fig. 19). This reduces the shift of the measuring position for those engaged in the measurement.

2-2-2 Measuring Distance

Measuring distance is defined as the distance between the lamp surface and the receiving lens of the instrument. The focal point is set on the lamp surface. Sanken standard measuring distance is 450±45 mm.

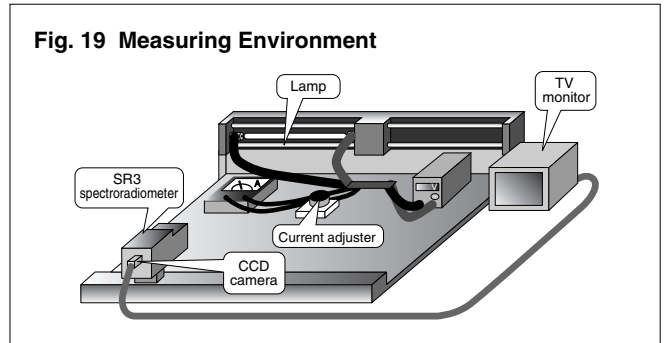

2-2-3 Time for Measurement

Measurement starts after luminance stabilizes. Since the time required for luminance to stabilize depends upon the time required for the lamp temperature to stabilize, it varies subject to lamp diameter, gas pressure, etc. (Fig. 20).

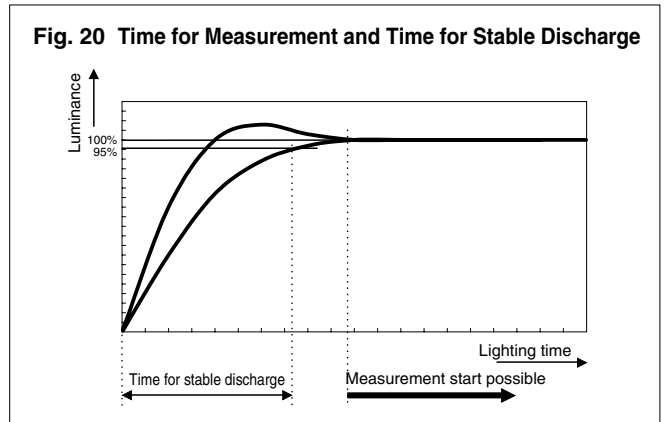

2-2-4 Measurement of Luminance and Chromaticity

Set the spectroradiometer or the luminance colorimeter vertically to the measuring surface and measure under the above conditions.

2-2-5 Precautions for Measurement

- (1) Avoid the influence of the shadow of mercury particles adhered to the lamp surface.
- (2) Since high frequency and high voltage are applied for lighting the CCFL, care must be taken of electric shock to human body, short circuit to metallic objects and firing or generation of smoke due to sparks.
- (3) Since very small amount of mercury is contained in the lamp, handle the lamp carefully to prevent inhalation of mercury particles, when it is broken.

2-2-6 Instrumental Error of Optical measuring Equipment

In general, each optical measuring instrument is likely to present different measurement values and even among the instruments of the same model, such differences of measured values (instrumental error) are found to the extent that the measured values need to be compensated. Instrumental error is briefly explained below for your reference.

One type of instrumental error of optical measuring instruments originates from manufacturer's calibration (accuracy limit) and another type is attributable to long-term use of the instrument (aging).

(1) Instrumental Error Originating from Manufacturer's Calibration (accuracy)

The accuracy of measurement of the luminance and chromaticity of the SR3 spectroradiometer which is the current standard equipment in the industry and the BM7 luminance colorimeter which was used as the standard equipment in the past, is summarized in the table below (quoted from the manufacturer's specifications).

Instrument	Accuracy *1 of luminance	Accuracy *1 of chromaticity	Accuracy *2 of chromaticity
Spectroradiometer SR3	±2%	Within ±0.002	Within ±0.005
Luminance colorimeter BM7	±4%	Within ±0.002	Within ±0.03

*1: When measuring Std A Light Source
*2: For radiations equivalent to CCFL (reference only)

Accuracy of chromaticity measurement published by the manufacturer is ±0.002 for both SR3 and BM7 as shown in the table above (Accuracy of Chromaticity *1). The user tends to believe that the instrumental error (accuracy) of the newly purchased or manufacturer-calibrated instrument is a maximum ±0.002 for chromaticity measurement.

Actually, however, the published accuracy is subject to the condition of using the Standard A Light Source (see Note *1). The declared accuracy is not achievable with CCFLs that have different color temperatures.

Then, what level of the accuracy (instrumental error after calibration) can we expect for the CCFL?

According to the equipment manufacturer, the accuracy of the SR3 spectroradiometer is ±0.005 for the CCFL. The accuracy of the BM7 luminance colorimeter is ±0.03 of the maximum value. This is because each tristimulus value is calculated by measuring the intensity of radiations passing through three RGB glass filters, and dispersion of the spectral transmittance of color glass filters installed in the instrument thus becomes the most important factor.

For supplementary information:

- Refer to Section 4, "Terminology," for the reference light.
- Refer to Section 5, page 22, for instrumental error of the Topcon luminance colorimeter (BM-series).

(2) Instrumental Error due to Aging (long-term use)

Measurement becomes unstable, when the instrument is used over a long period of time. Generally, the measured chromaticity tends to shift to the higher side, while the measured luminance tends to shift to the lower side. Major reasons of these shifts include variation in the transmittance of the optical system due to stains, variation in the sensitivity of receiving elements and change in the resistance of the board due to humidity. To deal with the inevitable instrumental error and

shift from the absolute value caused by aging, the user must control the variation within a certain allowable range by compensating the measured values and calibrating the equipment periodically.

(3) Instrumental Error with Measuring Instrument beyond Control

With respect to these two types of instrumental error, each manufacturer warrants and controls the measured values by setting compensation values for each piece of equipment and implementing periodical calibration using their standard measuring instruments and standard light source.

However, the instrumental error of uncontrollable measuring instruments is, in reality, totally unknown. The same measurement results are never warranted, even when using measuring instruments of the same type for the reasons stated above. To compare with the measurements by uncontrollable instruments, we need to measure the same light source under the same conditions to evaluate the instrumental error.

(4) Standardization of Measured Values

As discussed in paragraphs (1) through (3) above, the measurement in absolute values is difficult for the measuring instrument for luminance and chromaticity. Lamp manufacturers and backlight manufacturers must evaluate correlation of measured values between them by setting correction factors for the relevant data. For example, the measured values for the same lamp by the lamp manufacturer and the backlight manufacturer are compared in the table below respectively after data conversion using the correction values shown in the parentheses.

	Luminance (cd/m ²)	Chromaticity x	Chromaticity y
Measured by backlight manufacturer	36000	0.260	0.272
Measured by lamp manufacturer	40000	0.250	0.260
Correction factor for evaluation	0.90 (ratio)	-0.01 (difference)	-0.012 (difference)

At Sanken, luminance data are converted by ratio and chromaticity by relativity. To compare the measured values by the backlight manufacturer with data of the lamp manufacturer using the correction factors, we use the equations shown in the table of Results of Conversion to Measured Values of Lamp Manufacturer.

	Luminance (cd/m ²)	Chromaticity x	Chromaticity y
Measured by backlight manufacturer	L1	x1	y1
Converted to measured values of lamp manufacturer	L1/0.9	x1 - 0.01	y1 - 0.012

Periodical checking of instrumental error and evaluation of both parties' measured values after correction are essential in the optical measurement of CCFL.

2-3 Measuring Effective Emission Length

Effective emission length is the section of emission length where luminance is at least 80% of the luminance measured at the center of the lamp with luminance roughly uniformly distributed along the axis of the lamp (Fig. 21). Measurement must be taken when luminance is sufficiently stable. The effective length is varied by lamp diameter, electrode type, etc.

2-4 Measurement of Time required for Stable Discharge

Time to stable discharge is the time for a CCFL to reach 95% of the luminance that is measured five minutes after applying the lighting voltage, assuming this to be 100% (Fig. 20).

It is important for the measurement that the lamp temperature and the ambient temperature are constant.

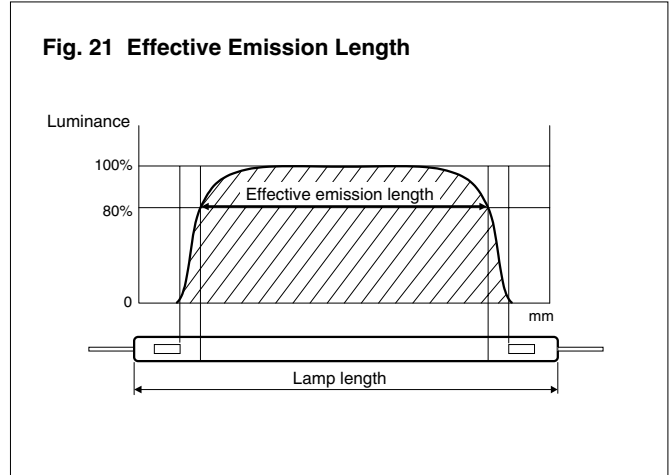

3 How to determine the Lamp Specifications (Verification of Matching of Lamp Specifications with Backlight)

The requirements for chromaticity for CCFLs are defined by the chromaticity required by the backlight. Backlight specifications and lamp specifications are correlated as shown below. At first, the correlation is confirmed and then lamp specifications are calculated.

Due to various improvements of the backlight LCD and the color filter, the established correlation between system and backlight or lamp can be no more effective. If we aim at the center value of

the CCFL requirement, the center value of the backlight requirement is missed. To ensure stable chromaticity for backlights at all times, chromaticity correlation between CCFL and backlight surface must be established and both requirements must be matched by aligning the center values of the CCFL and the backlight requirements (refer to Reference Materials for Selection of Lamp Specifications).

[Reference Materials for Selection of Lamp Specifications]

A Typical Procedure to Match Backlight and Lamp

Results of measurement of B/L and Lamp	Instrument	Luminance	x	y
B/L Spec Center		L1	x1	y1
B/L measured value	SR-3	L2	x2	y2
Lamp Spec Center		L3	x3	y3
Lamp measured value (B/L measured unit)	SR-3	L4	x4	y4

		Luminance	x	y
Center of CCFL only	max	—	typ +0.01	typ +0.01
	typ	$L4 - (L2 - L1)$	$x4 - (x2 - x1)$	$y4 - (y2 - y1)$
	min	—	typ -0.01	typ -0.01

(max. and min. values apply to general cases)

Conclusion

Value for lamp only to match B/L typical chromaticity	Chromaticity	Typical value for center of lamp alone	Correction factor (for the current CCFL standard value)
	x	$x4 - (x2 - x1)$	$\{x4 - (x2 - x1)\} - x3$
	y	$y4 - (y2 - y1)$	$\{y4 - (y2 - y1)\} - y3$

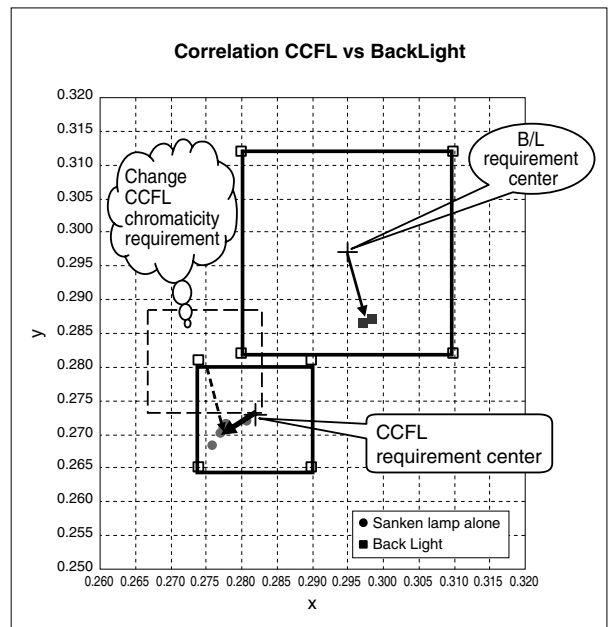

* In the above figure, we can aim at the center value of B/L chromaticity requirement by shifting the center value of the CCFL requirement in a manner that the deviation of CCFL chromaticity from the center of the standard equals the deviation of B/C chromaticity from the center value of the requirement.

4 Terminology

The terms relating to the CCFL are defined below.

◆ Luminance

The volume of luminous flux per unit area. Generally it represents the level of luminance of the light emitting (reflection/transmission) from surface.

Unit: cd/m^2 . nt or nit is also used.

◆ Luminous intensity

The level of luminous flux per unit solid angle, which is emitting from a light source to all directions. Generally it represents the intensity of point source light. Unit: candela (cd). Solid angle: The surface area of a unit sphere ($r = 1\text{m}$) is equivalent to a solid angle of 4π .

◆ Illuminance

The ratio of light flux per unit surface, which falls from all directions to a minute surface. Unit: lux (lx) = lm/m^2

Illuminance is the volume of incident luminous flux per unit area. Luminous radiance is the volume of emitting luminous flux per unit area. Luminance is the luminous intensity emitting from per unit area with directional movement.

◆ Chromaticity

Numerically defined types of color excluding luminance. It is neither luminance nor luminous intensity but the color quality of the light, which is defined by chromaticity coordinate whose hue to chroma of the light is correlated. Chromaticity is generally plotted by x- and y-coordinate values. Representation on plane coordinates is called as a chromaticity diagram.

◆ Color temperature

Assuming that object and celestial body radiations in the visible range are blackbody radiations, the black body temperature having the chromaticity same as that of the radiations. Unit: Kelvin (K). The higher the color temperature, the light contains more short-wave radiations with bluish color. The lower the color temperature, the light contains more long-wave radiations with reddish color.

◆ Blackbody radiation

Thermal emission from the object (blackbody) which is assumed to absorb all wavelengths radiations.

Blackbody radiation is influenced only by temperature and its magnitude is given by Planck's law.

◆ Luminous flux

The value of radiant flux evaluated by CIE standard spectral luminous efficiency and the maximum visibility. Generally it represents the volume of light. Unit: lumen (lm)

◆ Quantity of light

He volume of luminous flux that is integrated by time.

Unit: lumen-sec (lm-s).

◆ Spectral distribution

Distribution of radiation wavelengths which is included in a small wavelength range with λ at its center.

◆ CIE standard spectral luminous efficiency

The inverse of the relative value for the radiance of monochromatic radiation of wavelength λ , where monochromatic radiation of the wavelength λ is determined equal to the luminance of radiations that are the standard for comparison under certain conditions of observation. The spectral luminous efficiency is normally standardized to have the maximum value of unity (1). The standard spectral luminous efficiency refers to the values agreed at CIE (International Commission on Illumination).

$V(\lambda)$: standard spectral luminous efficiency with photopic vision
(max. visibility: 555 nm 683 lm/W)

$V'(\lambda)$: standard spectral luminous efficiency with scotopic vision
(max. visibility: 507 nm 1700 lm/W)

◆ Visible radiation

The radiation which enters human eyes and excite a visual sense. (Within the range of radiations recognized by human being) Generally, the radiation in the wavelength range of 380 nm to 780 nm is called visible radiations (visible light).

◆ Light of standard

Color temperature is measured by a color temperature meter. The light source used as the standard for the color temperature meter is called as the standard light source. CIE classifies the light of standard as A, B, C or D.

Light of standard A is the light of the perfect radiator of 2856K. To generate this light, a gas-filled tungsten lamp (transparent lamp) close to 2856K is used. This standard was set in 1968, and is very different from the chromaticity of CCFLs. Accuracy for measuring the CCFL equivalent radiations cannot be within the manufacturer warranted accuracy of ± 0.002 .

Light of standard B is the light of 4874K. Light of standard C is equivalent to the light of 6774K. These lights simulate sun light. Radiations of 4875K are yellowish daylight while those of 6774K resemble to bluish daylight. To generate these lights, a filter (Davis-Gibson filter B or C) with a solution of a specified composition is mounted on lamp A.

Light of standard D65 represents daylight of a color temperature of approximately 6504K. Spectral distribution is statistically studied under natural sunlight and the values are specified by wavelength. CIE has developed and published the method to calculate the spectral distribution of daylight of any color temperature in the 4000K to 25000K range to describe light D. D65 is one of the radiations defined by the above method. The light of standard shows that it is equal to sunlight itself or radiations from the perfect blackbody.

5 Error of Topcon Luminance Colorimeter (BM-series)

The Topcon BM-series luminance colorimeter combines spectroscopic transmittance of the optical system with color glass filters and receptor elements to approximate the spectroscopic responsivity of color-matching function.

Spectroscopic transmittance of color glass filters is the most important factor for approximating the spectroscopic responsivity. If characteristics of color glass filters are uniformly fabricated, instrumental error will be reduced. However it is difficult to realize that, and even among products of the same series (BM-5A, BM-7, etc.), there is certain variation in spectroscopic characteristics.

Spectroscopic responsivity of equipment is defined in accordance with JIS Z 8724 Methods of Measurement for Light Source Color.

However, even if the JIS requirements are satisfied, some products have different spectroscopic characteristics as shown below.

* BM-(1) and BM-(2) in the figure below are not actual products.

Because products are calibrated by using the standard light source A, no instrumental error occurs in terms of light A.

Fig. 22 Spectroscopic Characteristics (y)

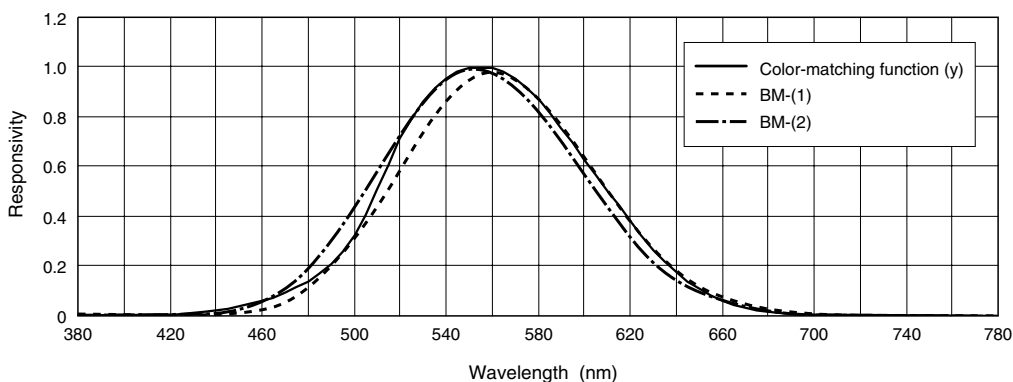

Let us assume measuring other light sources with respect to spectroscopic characterization.

Assume two imaginary sample light sources 1 and 2 with their peak wavelengths have 40 nm difference like the figure shown below. If two BMs with spectroscopic characteristics BM-(1) and (2), are used to measure sample light source 1, Instrumental error

between the two BMs will be small. However when sample light source 2 is measured, the instrumental error between the same two BMs will increase. (Two BMs have a similar sensitivity for sample light source 1 while they clearly show instrumental error for sample light source 2.)

Fig. 23

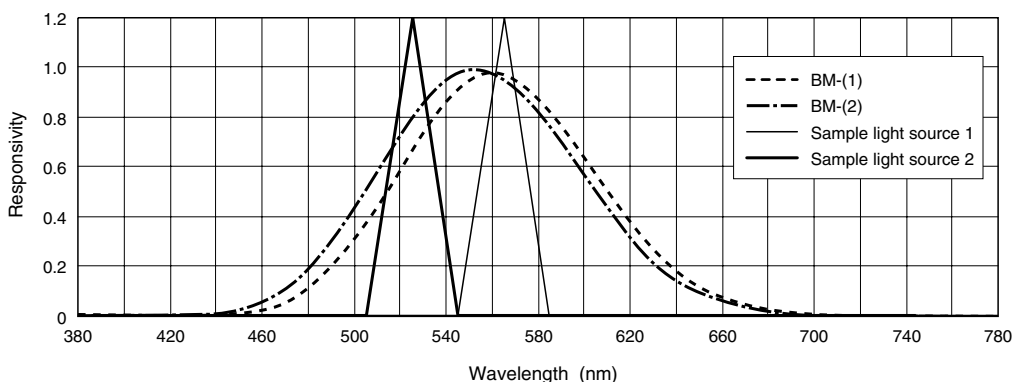

Instrumental error between two BMs can increase, even when measuring a light source with the same peak wavelength. For example, in the figure below, instrumental error is greater when sample light source 4 was measured rather than when sample light

source 3 was measured. (For sample light source 3, the output exists only in the area where the BM sensitivity is nearly identical while for sample light source 4, the output also exists in areas where the difference in sensitivity between two BMs increases.)

Fig. 24

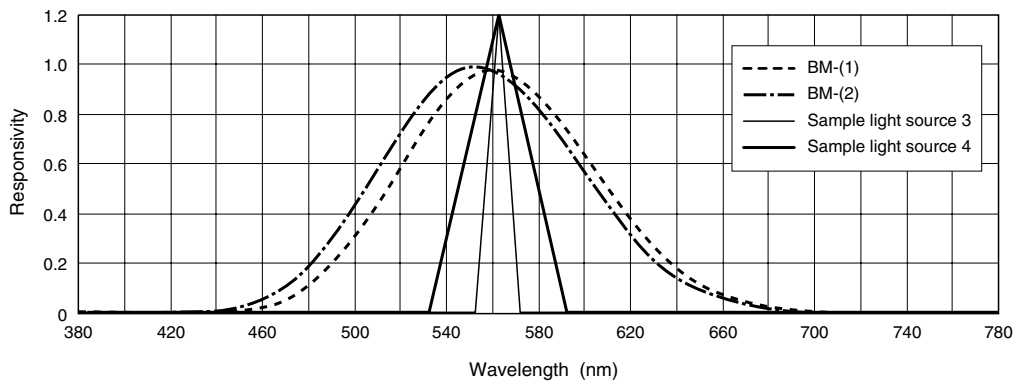

As described above, the instrumental error is closely related to the spectral characteristics of the instrument and the light source to be measured. This also applies to the tristimulus values XYZ.

Therefore it is impossible to define BMs' instrumental error uniformly.

● Current Dimming and PWM Dimming

PWM dimming has a wider adjustable range than current dimming. The adjustable range of current dimming is normally about 50%. Less than 50% dimming is available with PWM dimming. Current dimming and PWM dimming on a self-excited inverter are compared in term of effective current and power on the luminance change graph shown below for your reference.

In the case of PWM dimming, even when the drive current (effective value) is the same as in current dimming, lamp voltage

and power tend to decrease, if the dimmer is turned down too much. This will lead to an abnormally low lamp surface temperature, making discharge unstable. In PWM dimming, if you overuse soft starts even though they are of the same duty, the lamp surface temperature falls making discharge unstable. It is recommended to determine whether the discharge is unstable or not by observing optical waveforms for the system.

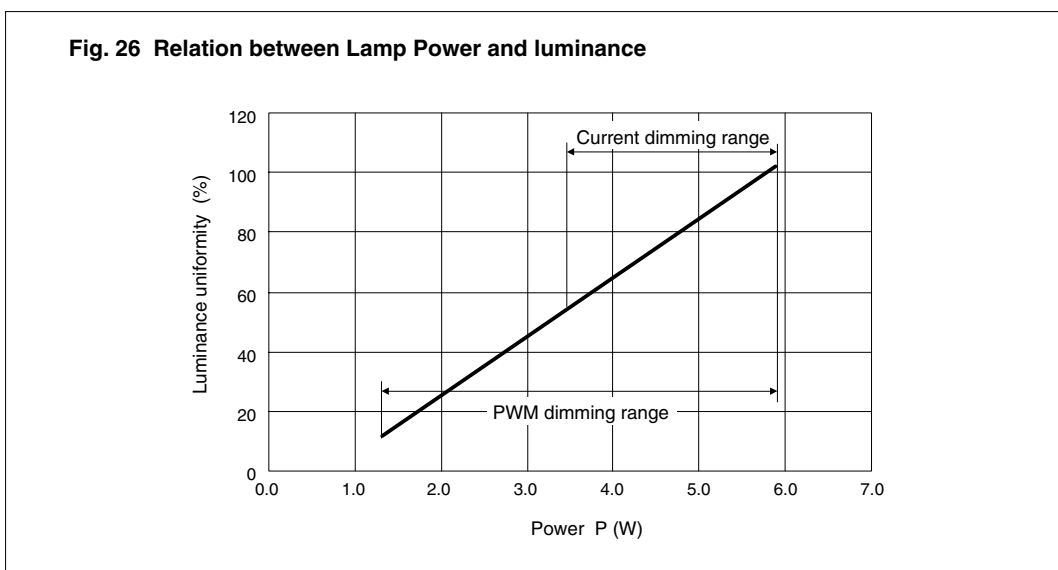
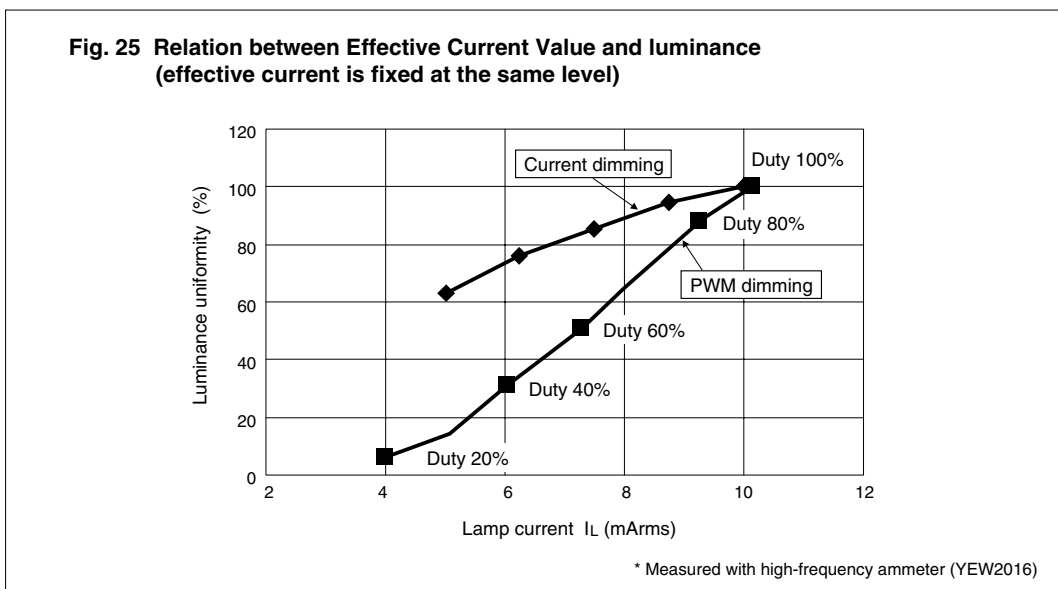

● CCFL leak current at the LCD Module

How to reduce the leak current

It is impossible to eliminate the leak current perfectly. There is an effect that a stray capacitance decreases the lighting start voltage. Therefore, it is recommended to decrease the leak current to the possible level in consideration of matching with Inverter.

$$\text{Leak current } I_s = 2\pi f C_s V_L$$

(1) By lowering the driving frequency f

If the driving frequency f is made too low, electric discharge becomes unstable and the luminance is decreased. In consideration of the luminance efficiency of the lamp, 50-60 kHz is currently prevalent. As the lamp diameter is smaller, it is necessary to raise the frequency for stable lighting.

(2) By reducing the stray capacitance Cs

$$C_s = \epsilon S/d$$

Widen the distance "d" between the high voltage wiring / lamp and the conductor portion (reflector, chassis etc.).

For example, a non-conductive reflector should be reviewed.

It is to be noted, however, that the metallic reflector has an effect of lowering the lighting start voltage.

(3) By reducing the Lamp Voltage VL (Reducing the lamp impedance)

The lamp voltage depends on the CCFL characteristics.

As the CCFL is thinner and longer, the lamp voltage becomes higher. As the gas pressure is higher, the impedance tends to be higher.

[Appendix] How to measure leak current

As a measuring method of the lamp current, please see "Case A" which is recommendable and "Case B" (not recommendable) as follows.

The measurement point of current is shown.

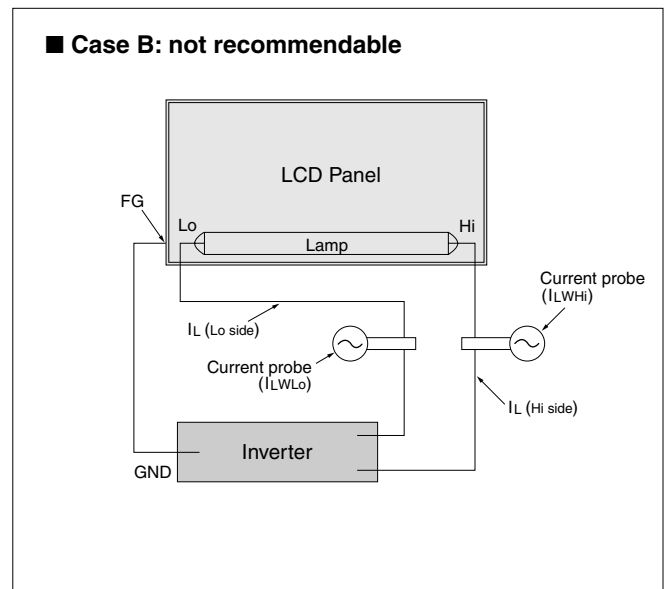
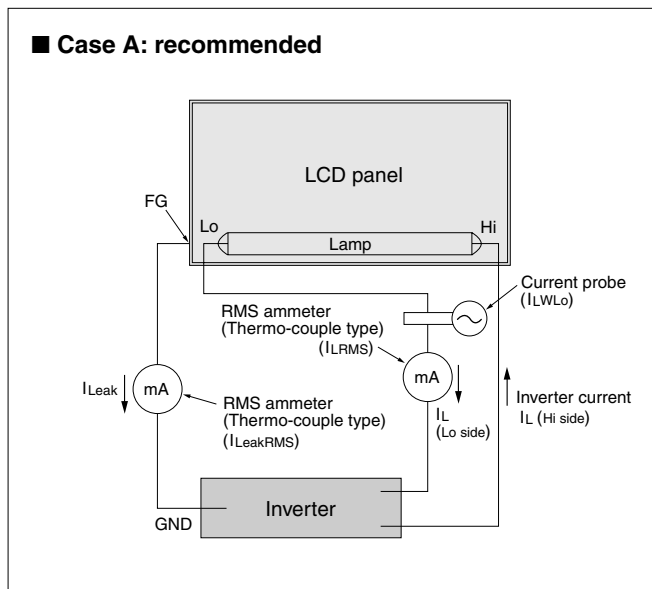

● **Case A**

Measure the lamp current and leak current with the RMS ammeter (Thermo-couple type). This is because the ammeter value is more accurate than the calculated value of the oscilloscope. The oscilloscope is used for checking the lamp current waveform (Crest & Imbalance Factor).

● **Case B**

This is a measuring method in which the difference between high side (IL) and low side (IL) is deemed as leak current {IL(Hi) – IL(LO)}. However, the accurate leak current cannot be obtained, because the current value (Hi side IL) is the value of the synthesized current (IL+I leak).

(Not scalar, but the sum of vector should be used.)

● **For your reference, let us explain the synthesis of the vector of Fig. 27.**

The sum of vector of lamp current and the leak current is equivalent to the current of the inverter.

The phase of inverter current advances against lamp current about 34.3° due to the influence of the C component of the panel.

As a result, inverter current, lamp current and leak current will be 7.3 mA, 6mA and 4. 1mA respectively.

This is expressed by the following equation:

- Inverter Current 7.3 mA
- Lamp Current 6 mA
- Leak Current 4.1 mA

$$\begin{aligned} \text{Inverter current [IL (Hi side)]} &= \sqrt{(I_{\text{Leak}})^2 + (I_{\text{L (Lo side)}})^2} \\ &= \sqrt{(4.1\text{mA})^2 + (6\text{mA})^2} \\ &= 7.3 \text{ mA} \end{aligned}$$

● **Incidentally, refer to Fig. 28 for the difference between the voltage phase and the current phase.**

The phase difference is 0 for component R (resistance), delays 90° for L component (coil) and advances 90° for component C (capacitor).

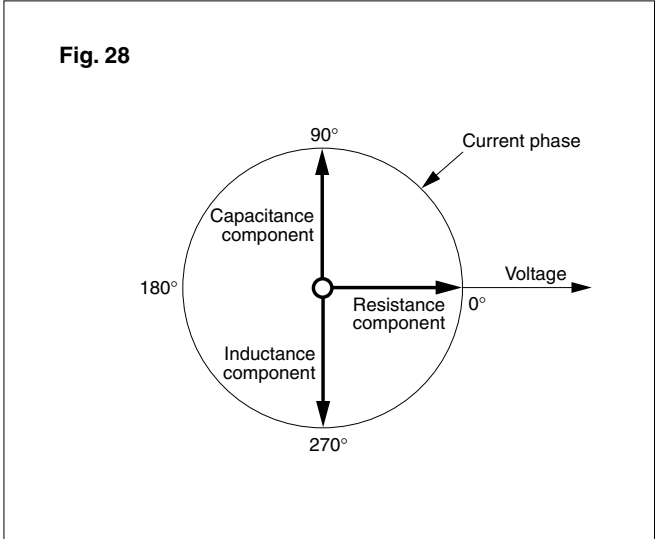
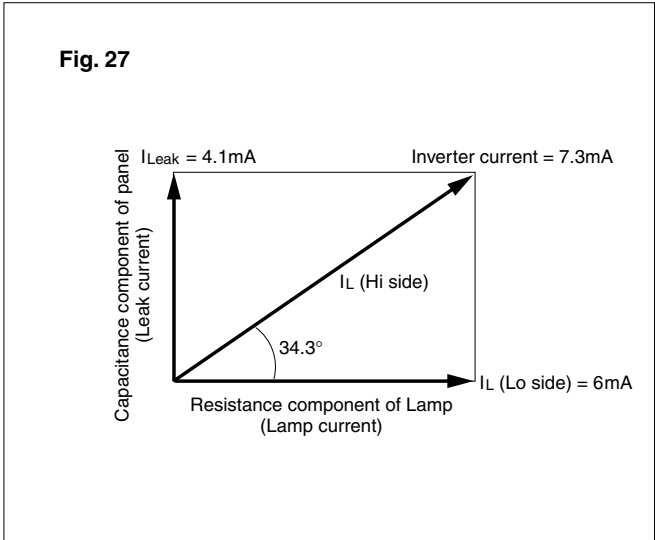

●Electrical Characteristics at Backlight System

The output voltage and current of the inverter to drive CCFLs are likely to be subject to the effect of stray capacitance, because the inverter applies high frequency and high voltage to the lamp which is a high impedance load.

Therefore, it is impossible to directly measure the voltage characteristics of a lamp (lighting start voltage and lamp voltage) in

the system. The lamp voltage and lamp current will change, when a probe is connected to high voltage terminals. For a ballast capacitor type, the effect of voltage division with the probe capacitance cannot be neglected.

A typical method to measure the voltage characteristics of a lamp in a system is described below for your reference.

1 Lighting start voltage at System

1-1 Measuring procedure of lighting start voltage

- (1) Prepare an inverter for the measurement which can vary the input voltage for variable outputs of the transformers.
- (2) Measure the input/output voltage characteristics of the measuring inverter (Fig. 29) before starting measurement of the lighting start voltage. Measure the transformer output voltage in no load state (output OPEN). Also measure the transformer output voltage, when using a ballast capacitor type.
- (3) Connect the measuring inverter to the lamp alone and measure the lighting start voltage V_{in1} (inverter input voltage) for the lamp only.
- (4) Mount the lamp in the system and measure in the step 3 above the lighting start voltage V_{in2} (inverter input voltage) for the system.
- (5) Using the values measured in steps (3) and (4), obtain the lighting start voltage for the lamp alone and for the system (V_{out1} and V_{out2} ; transformer output voltage) from the inverter input/output voltage characteristics in Fig. 29.

which the lamp and the conductive area are kept apart from each other, reduction in the lighting start voltage due to the effect of adjacent metal frames is hardly anticipated. Check capacitance of the ballast capacitor and the lighting frequency.

- For the separately-excited ballast capacitorless inverter, output voltage will vary (in relation to lighting frequency) because the resonance frequency of the high voltage circuit is affected by the stray capacitance. Always check the lighting on the actual system. Check the lighting frequency under the actual system condition.
- The lighting start voltage of a CCFL reaches the peak value at low temperature. Check at the low temperature (0°C) under the actual machine condition.
- When measuring inverter input voltages V_{in1} and V_{in2} (inverter input voltages), apply the voltages V_{in1} and V_{in2} directly, instead of gradually increasing the inverter input voltage to determine if the lamp lights in a few seconds or not.
- The inverter for the measurement is designed to vary the transformer output by varying the input. Ordinary inverters are controlled in a manner that the transformer output is constant, even if the input is varied. Contact our Engineering Dept or the inverter supplier for detailed converter specifications.

Fig. 29 Inverter Input/Output Voltage Characteristics

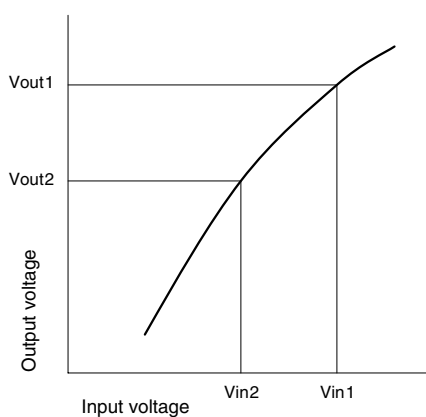

V_{in1} : Lighting start voltage for lamp only
 V_{in2} : Lighting start voltage for the system
 V_{out1} : Lighting start voltage for lamp only
 V_{out2} : Lighting start voltage for the system

[Cautions]

- When using a ballast capacitor type inverter, the voltage applied to the lamp falls due to the relation between capacitance of the ballast capacitor and the stray capacitance. For a laptop PC or a monitor, reduction in the lighting start voltage due to the effect of adjacent metal frames is expected. In the case of a directly-below type in

1-2 Setting Standard for Lighting start voltage for System

Set the standard for the Lighting start voltage for the system as follows:

	Lighting start voltage		Measuring position
	typ	max	
Lamp requirement	VL typ	VL max	Lamp ends
System requirement	V_{out2}	V_{max}	Transformer output

VL typ: Typical lighting start voltage at ends of the lamp (standard value for the lamp)

VL max: Max. lighting start voltage at ends of the lamp (standard value for the lamp)

V_{out2} : Typical value of transformer output at lighting in the system (standard value for the system)

V_{max} : Maximum value of transformer output at lighting in the system (standard value for the system)

$$V_{max} = VL_{max} - VL_{typ} + V_{out2}$$

[Cautions]

- A typical lamp should be used when performing the measurement. When ordering from us, specify the standard product for the

measurement.

- The standard for the lighting start voltage for the system should be defined at the inverter transformer output. When using a ballast capacitor type inverter, the value of the ballast capacitor should be

stated. The lighting start voltage varies with the value of the ballast capacitor.

- Specify the lighting start frequency of the inverter. Lighting start voltage varies with the starting frequency.

2 Lamp Voltage and Lamp Power at System

2-1 Measuring Method of Lamp Voltage and Lamp Power

- (1) In the system state, connect the voltage probe to the lamp at the high voltage side and connect the current probe to the lamp at the low voltage side.
- (2) Measure the voltage-current characteristics of the lamp by varying the output of the measuring inverter before starting measurement of lamp voltage and lamp power. Take measurements at the system in thermally saturated state.
- (3) Remove the voltage probe from the high voltage side and measure the lamp current for each lamp under the rated system condition (max. dimming). Take measurements when the system has reached thermal saturation. The lamp current is measured on the low voltage side of the lamp.
- (4) Determine the lamp voltage corresponding to the current value measured in step (3) using the data from step (2) and find the lamp power for each lamp. The sum of the lamp power values is the total power (WL) of the backlight.
- (5) Inverter efficiency (η) is defined by the ratio of total power of the backlight (WL) to input power of the inverter (W_{in}).

$$\text{Inverter efficiency } \eta = (WL/W_{in}) \times 100 (\%)$$

[Cautions]

- Connect the GND of the case of the system to the GND of the inverter without fail.
- When using two or more lamps, match the phase of the voltage applied to each lamp. In system design, consider the insulation distance between neighboring lamps (lamp leads) when phase inversion is expected in the application.
- In the design of your inverter, consider the leakage current (reactive power) when determining power.
- Specify for us the inverter starting frequency that is determined under the actual machine condition. Lamp voltage varies with the lighting frequency.
- Measurement of the lamp current in the backlight system of the both-ends high voltage type is practically difficult. Sanken recommends, for example, installing a current measuring terminal, etc. at the neutral point of the transformer.

●Table of CCFL Inverter for Measurement and Aging

Type	Corresponding CCFL outer diameter	Corresponding CCFL length	Lamp power	Lamp current (per 1 lamp)	DC input voltage (min)	Open circuit output voltage (min)	Dimming control	Outline (mm)	Page
SCF-0278	φ1.8/2.0/2.2mm	270 to 320mm	4.2W x 1 lamp	7mA	12±1.2V	1,500Vrms	Current	95 x 19.8 x 10	30
SCF-0281	φ2.0/2.2mm	270 to 320mm	4.2W x 1 lamp	8.3mA	12±1.2V	1,500Vrms	Current	95 x 19.8 x 10	32
SCF-0290	φ3.0 to 4.0mm	700 to 1,000mm	12.0W x 1 lamp	16.4mA	20±2.0V	1,600Vrms	Current/PWM	25 x 12.8 x 13	36

We will offer custom design for mass production inverters.

Please contact Sanken sales office.

CCFL Inverter

● SCF-0278 (4.2W x 1 lamp)

● Features

- Built in On/Off control function
- Regulated lamp current
- Built-in dimming control circuit. (Current mode)
- Insulation case and cable (MP-0073, 0074) attached
- Applications: 13-15 inches LCD size class for evaluation, aging test
 Suitable Sanken's CCFL: Lamp length 270 to 320 mm
 : Outer diameter ϕ 1.8, 2.0, 2.2 mm

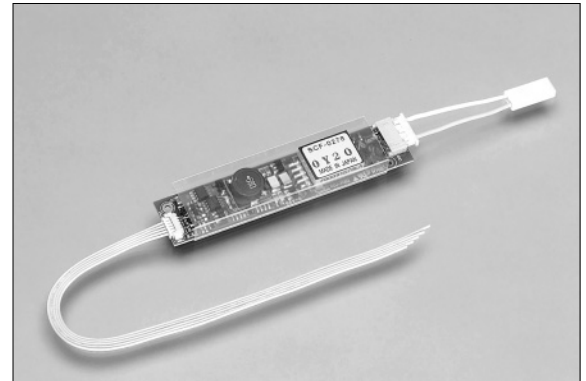

● Outline and dimensions

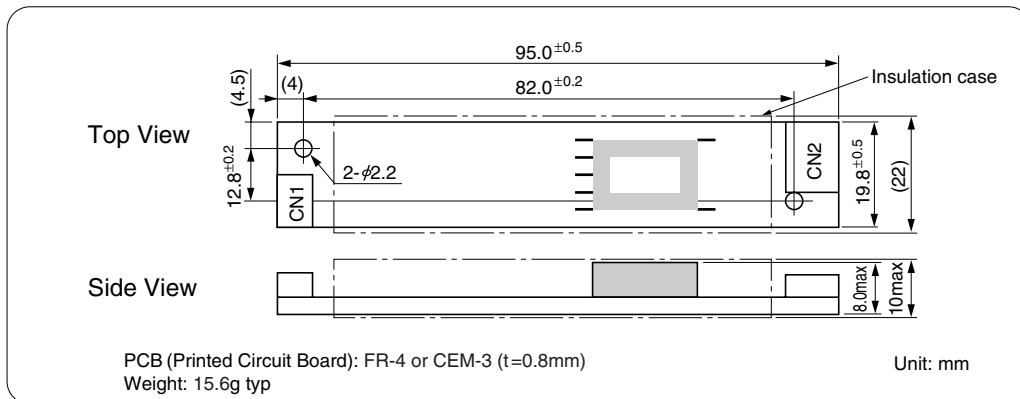

● Connector Terminal Number and Function

With input and output cables

Terminal	Terminal No.	Symbol	Function	Connector type name / Manufacturer
CN 1 (Input)	1	V _{IN}	DC input voltage	53261-0590 / molex
	2	GND	Input GND	
	3	V _{rmt}	On-Off control	
	4	R _{br}	Dimming control	
	5	N.C		
CN 2 (Output)	1	Lamp-H	Output high side	SM02(8.0)B-BHS-TB / JST
	3	Lamp-L	Output low side	

● Application Circuit

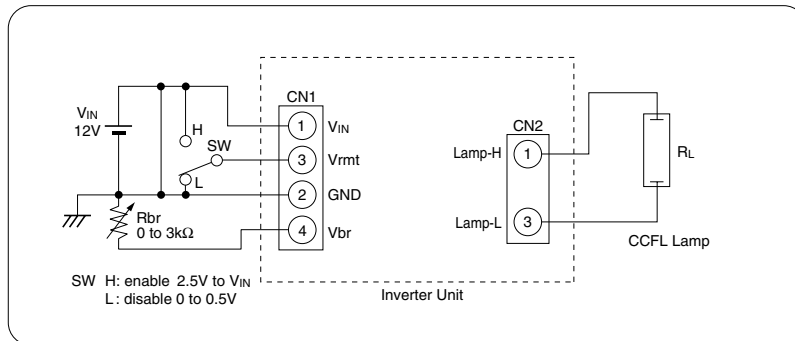

● Absolute maximum ratings

Item	Symbol	Ratings	Unit	Remarks
DC input voltage	V_{IN}	0 to 15	V	
On/Off voltage	V_{rmt}	0 to 15	V	
Dimming resistance (voltage)	R_{br} (V_{br})	0 to 5 (0 to 2)	k Ω (V)	
Lamp power	P_L	4.9	W	$R_L \leq 100k\Omega$
Operating temp	T_{opr}	0 to 60	$^{\circ}C$	
Storage temp	T_{stg}	-20 to 80	$^{\circ}C$	
Humidity	RH	95	%RH	Maximum wet-bulb temperature 38 $^{\circ}C$ No dew condensation

● Electrical characteristics

Conditions: at $T_{opr}=25^{\circ}C$, $V_{IN}=12V$ (unless otherwise specified)

Item	Symbol	Specifications			Unit	Remarks
		min	typ	max		
Recommended input voltage range	V_{IN}	10.8	12	13.2	V	
Input current	I_{IN}	—	—	500	mA	$V_{IN}=12V$, $I_L=7mA_{max}$
Driving frequency	f_{sw}	45	50	55	kHz	$R_L=85k\Omega$
Lamp current	I_L	—	7.0	—	mArms	$R_L=85k\Omega$, $R_{br}=0\Omega$
		—	4.0	—	mArms	$R_L=85k\Omega$, $R_{br}=3k\Omega$
Lamp power	P_L	—	4.2	—	W	$R_L=85k\Omega$
Open voltage	V_o	1500	—	—	Vrms	$V_{IN}=12V$, $R_L=100M\Omega$

● Dimming characteristics

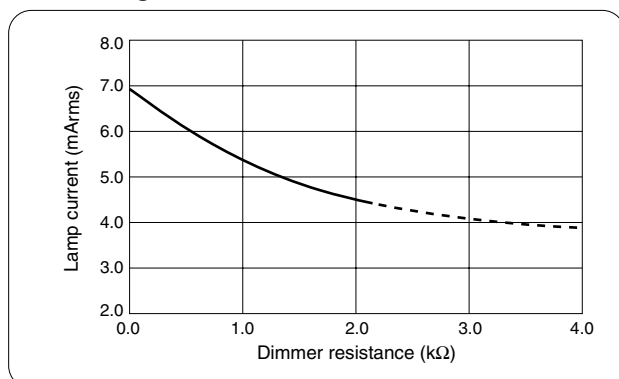

[Cables included as accessories]

- (1) Input cable: MP-0073 (Cable length 200mm)
 - (2) Output conversion connector: MP-0074 (3 pin type → 2 pin type)
- Adopted socket housing: BHRS-02VS-1

CCFL Inverter

● SCF-0281 (4.8W x 1 lamp)

● Features

- On/Off terminal provided
- Regulated lamp current
- Dimming control function using external resistor. (Current mode)
- Insulation case and cable (MP-0073, 0074) attached
- Applications: LCD panel size of 13 – 15 inches class, evaluation, operation test

Applicable Sanken's CCFL: Lamp length 270 to 320mm
 : Outer diameter ϕ 1.8, 2.0, 2.2mm

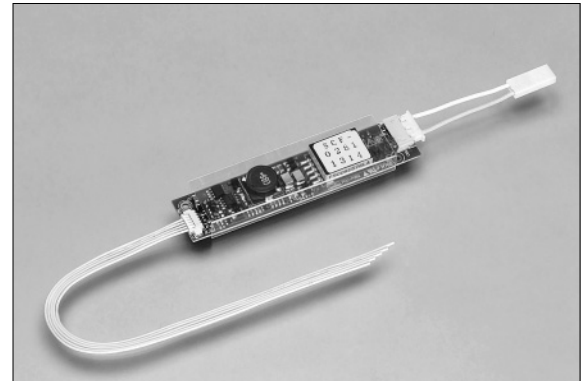

● Outline and dimensions

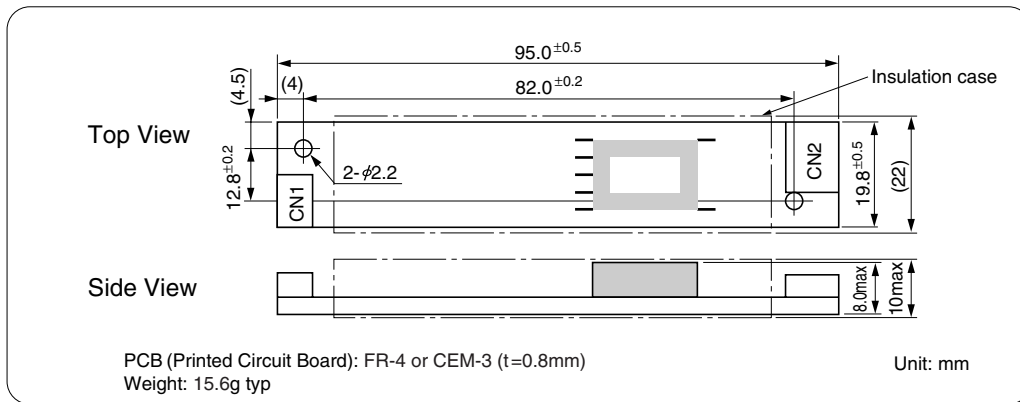

● Connector Terminal Number and Function

With input and output cables

Terminal	Terminal No.	Symbol	Function	Connector type name / Manufacturer
CN 1 (Input)	1	V_{IN}	DC input voltage	53261-0590 / molex
	2	GND	Input GND	
	3	Vrmt	On-Off control	
	4	Rbr	Dimming control	
	5	N.C		
CN 2 (Output)	1	Lamp-H	Output high side	SM02(8.0)B-BHS-TB / JST
	3	Lamp-L	Output low side	

● Application Circuit

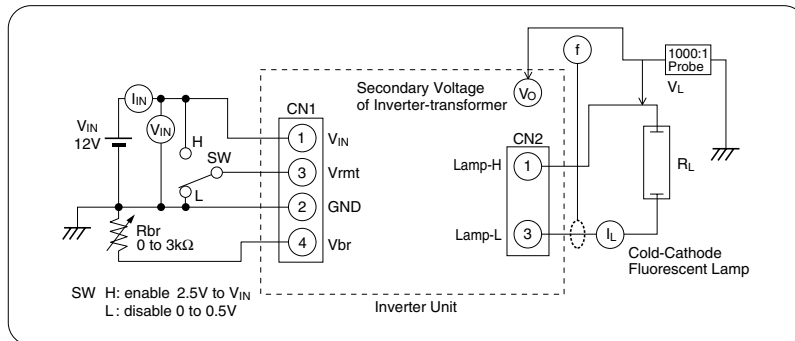

● Absolute maximum ratings

Item	Symbol	Ratings	Unit	Remarks
DC input voltage	V_{IN}	0 to 14	V	
On/Off voltage	V_{rmt}	0 to 14	V	
Dimming resistance (voltage)	R_{br} (V_{br})	0 to 5 (0 to 2)	$k\Omega$ (V)	
Lamp power	P_L	4.9	W	$R_L \leq 70k\Omega$
Operating temp	T_{opr}	0 to 50	$^{\circ}C$	
Storage temp	T_{stg}	-20 to 80	$^{\circ}C$	
Humidity	RH	95	%RH	Maximum wet-bulb temp. 38 $^{\circ}C$ No dew condensation

● Electrical characteristics

Conditions: at $T_{opr}=25^{\circ}C$, $V_{IN}=12V$ (unless otherwise specified)

Item	Symbol	Specifications			Unit	Remarks
		min	typ	max		
Recommended input voltage range	V_{IN}	10.8	12	13.2	V	
Input current	I_{IN}	—	—	600	mA	$V_{IN}=12V$, $I_L=8.3mA_{max}$
Driving frequency	f_{sw}	45	50	55	kHz	$R_L=70k\Omega$
Lamp current	I_L	—	8.3	—	mArms	$R_L=70k\Omega$, $V_{br}=0V$
		—	4.8	—	mArms	$R_L=70k\Omega$, $V_{br}=2kV$
Lamp power	P_L	—	4.8	—	W	$R_L=70k\Omega$
Open voltage	V_o	1500	—	—	Vrms	$V_{IN}=12V$, $R_L=100M\Omega$

● Dimming characteristics

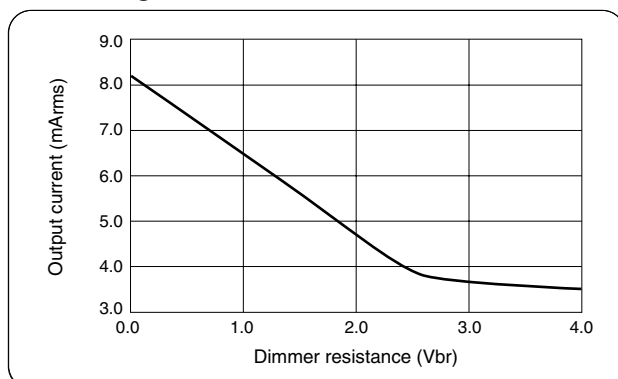

[Cables provided as accessories]

- (1) Input cable: MP-0073 (Cable length 200mm)
 - (2) Output conversion connector: MP-0074 (3 pin type → 2 pin type)
- Adopted socket housing: BHSR-02VS-1

CCFL Inverter

●Accessories for SCF-0278 / SCF-0281

Parts for Input Cable MP-0073

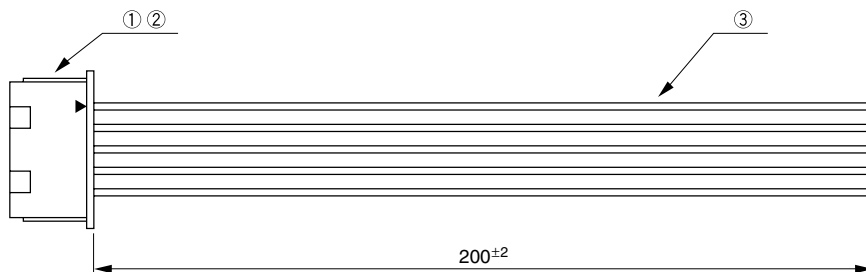

Part list

Item	Type	Manufacturer	Part No.	Quantity	Remarks
①	Housing	molex	51021-0500	1	
②	Terminal	molex	50058-8xx	5	
③	Covering wire	Sumitomo, etc.	UL1061AWG#28 (White)	1100mm	No terminal treatment

Parts for Output-Conversion-Cable (3 pin type → 2 pin type) MP-0074

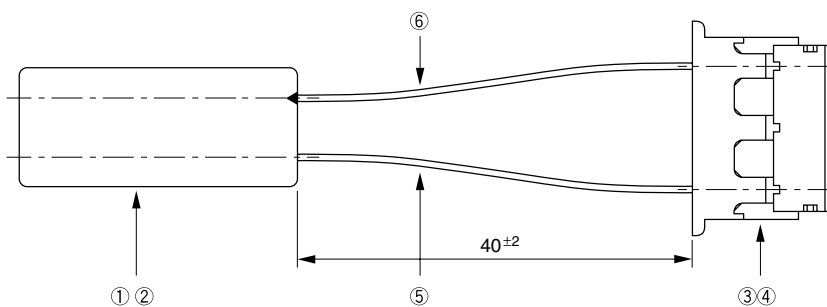

Part list

Item	Type	Manufacturer	Part No.	Quantity	Remarks
①	Housing	JST	BHSMR-02VS	1	
②	Contact	JST	SBHSM-002T-P0.5	2	
③	Housing	JST	BHR-03VS-1	2	
④	Contact	JST	SBH-001T-P0.5	2	
⑤	Covering wire	Nissei, etc.	UL3239AWG#24(White)	45mm	
⑥	Covering wire	Nissei, etc.	UL3239AWG#24(Pink)	45mm	



CCFL Inverter

● SCF-0290 (12.0W x 1 lamp)

● Features

- Series resonance type using dedicated control IC
- On/Off terminal provided
- Analog and PWM dimming functions provided
- Ballast capacitor-less
- Low distortion lamp current
- Protection functions (Open lamp, lamp hi side or lo side vs. GND short circuit)
- Constant driving frequency of lamp current
- High efficiency (Power efficiency 80% min.)
- Regulated lamp current
- Applications: LCD panel size of 30 – 40inch class, evaluation, operation test

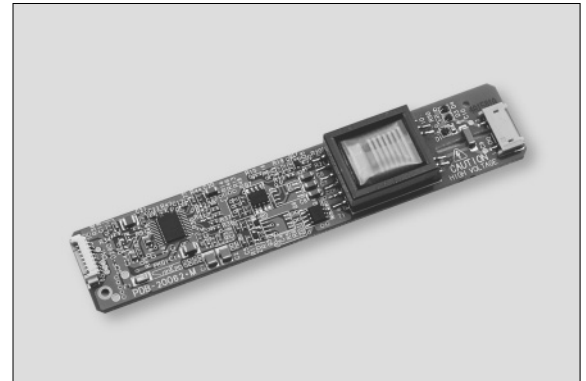

Applicable Sanken's CCFL: Lamp length 700 to 1,000mm

: Outer Diameter $\phi 3.0\text{mm}$ (I.D. 2.0mm) to $\phi 4.0\text{mm}$ (I.D. 3.0mm)

● Outline and dimensions

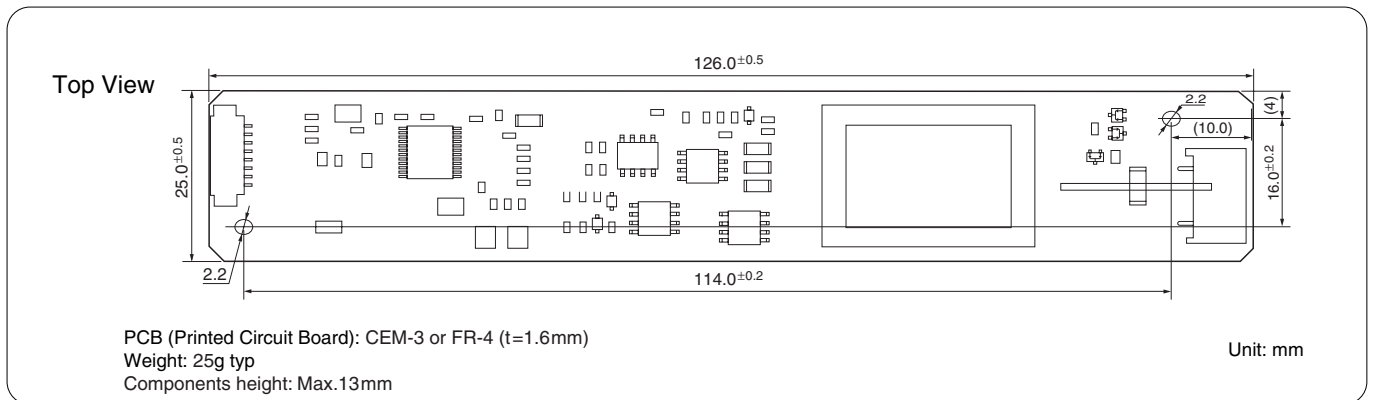

● Terminal Number and Function

Terminal	Terminal No.	Symbol	Function	Connector type name / Manufacturer
CN 1 (Input)	1	V _{IN}	DC input voltage (20V±10%)	53261-0810 / molex
	2			
	3	V _{cnt}	Enable: 2.5 to 5.0V, Disable: 0 to 0.8V	
	4	GND	Input GND (0V)	
	5			
	6	A-dim	Analog dimming	
	7	P-dim	PWM dimming	
	8	C-GND	Control GND	
CN 2 (Output)	1	V _{out-Hi}	CCFL Hi side (780V, 16mA)	SM02(8.0)B-BHS-TB / JST
	2	V _{out-Lo}	CCFL Lo side	

● Absolute maximum ratings

Item	Symbol	Ratings	Unit	Remarks
DC input voltage	V_{IN}	-0.3 to 24	V	Recommended input voltage: +20V typ $\pm 10\%$
ON/OFF control voltage	V_{cnt}	-0.3 to V_{IN}	V	Disable: 0 to 0.8V, Enable 2.5 to 5 V
Analog dimming voltage	V_{ad}	-0.3 to 4	V	Max brightness: 0V, Min brightness: 3.3V
PWM dimming voltage	V_{pd}	-0.3 to 4	V	Max brightness: 0 to 0.5V, Min brightness: 1.6V
Operating temperature range	T_a	-5 to +55	$^{\circ}\text{C}$	Max 40 $^{\circ}\text{C}$ (13 to 16mA)
Storage temperature range	T_{stg}	-20 to +80	$^{\circ}\text{C}$	
Operating humidity range	RH	20 to 95	%RH	Maximum wet-bulb temperature 38 $^{\circ}\text{C}$ No dew condensation
Storage humidity range	RH	5 to 95	%RH	

● Electrical characteristics

Item	Symbol	Condition	Specifications			Unit	Remarks
			min	typ	max		
Input current	I_{IN}	$V_{ad}=V_{pd}=0\text{V}$	—	(0.74)	0.85	A	*1
Driving frequency	f_{sw}		44	(49)	54	kHz	
Output current	I_o		15.8	16.4	17.0	mA	
	I_{o-ad}	$V_{ad}=3.3\text{V}$, $V_{pd}=0\text{V}$	2.2	2.8	3.4	mA	*1
	I_{o-pd}	$V_{ad}=0\text{V}$, $V_{pd}=1.60\text{V}$	5	6	7	mA	
Open voltage	V_o	$V_{ad}=V_{pd}=0\text{V}$	1,600	—	2,000	V _{rms}	*2
Lamp voltage	V_L		—	(780)	—	V _{rms}	Standard lamp
Dimming frequency	f_{PWM}	$V_{ad}=0\text{V}$, $V_{pd}=1.60\text{V}$	180	(220)	260	Hz	
OPEN detect	OLP	$V_{ad}=V_{pd}=0\text{V}$	(0.6)	(1.0)	(1.4)	mArms	*3



*1: At the specified impedance connection (lamp equivalent resistance 50k Ω /25W min.)

*2: $V_{IN} = 18\text{V}$ at no load

*3: Stop the inverter operation at load open.

Control IC for CCFL Inverter

●Control IC for CCFL Inverter

	Part Number		
	STR-H2003	STR-H2005	STR-H2022
			
Package	VSOP24	TSSOP16	VSOP30
Input voltage	6.7 to 25V	6.9 to 24V	10.5 to 28V
High voltage driver	—		Built-in 150 V driver
Control	PWM with constant driving frequency		
	Full bridge series resonance type		
	P-N MOS drive		All Nch MOS drive
Protection Function	Output OPEN protection		
	Output short protection	High-speed OCP	
	Delay latch protection		
	Two soft starts functions: at power on and starting burst dimming		
	—	Protection against abrupt change in input	—
Synchronization	—		Driving frequency sync
	—		Horizontal signal sync
	—		Bridge phase sync
	—		Auto reset from out-of-phase

*Contact your nearest sales office for details.

Regulator IC

● Linear Regulator IC (built-in low loss circuit, and overcurrent and overheat protection circuits*)

* : No overheat protection for SI-3000V series

● Surface Mount Type

Series Name	Output current (A)	Output voltage (V)							Variable (ref. voltage) (V)					Package	Low consumption current at OFF	Output ON/OFF	Overcurrent protection characteristics
		1.8	2.5	3.3	5	9	12	15	1.0	1.1	1.25	1.28	2.5				
SI-3000LUS	0.25	◎	◎	◎	◎									SOT89-3	—	—	Current limiting
SI-3000LU	0.25	◎	△	◎	◎						◎			SOT89-3	○	○	Current limiting
SI-3000HM	0.5			△	△	△	△		△				△	TO252-5	○	○	Foldback
SI-3000LSA	1.0	◎	◎	◎	◎									SOP8	○	○	Foldback
SI-3000KS	1.0	◎	◎	◎								◎		SOP8	○	○	Current limiting
SI-3000KMS	1.0	◎	◎	◎	◎	◎	△	△						TO252-3	—	—	Foldback* ¹
SI-3000KM	1.0	◎	◎	◎	◎	◎	◎	△	◎			◎		TO252-5	○	○	Foldback* ²
SI-3000KD	1.0	◎	◎	◎	◎	△	△	△	◎			◎		TO263-5	○	○	Foldback* ³
SI-3000LLSL	1.5								◎					SOP-8	○	○	Foldback
SI-3000ZD	3.0		◎	◎						◎				TO263-5	○	○	Foldback

△ : Samples being distributed ◎ : Available
 *1: Current limiting for SI-3018KMS/3025KMS/3033KMS
 *2: Current limiting for SI-3012KM/3018KM/3025KM/3033KM
 *3: Current limiting for SI-3012KD/3018KD/3025KD/3033KD

● Thru-hole Type

Series Name	Output current (A)	Output voltage (V)								Variable (ref. voltage) (V)			Package	Low consumption current at OFF	Output ON/OFF	Overcurrent protection characteristics		
		1.8	2.5	3.3	5	9	12	15	15.7	24	1	1.1					2.55	
SI-3000B	0.27									◎				◎	TO220F-5	—	○	Foldback
SI-3000N	1.0				◎	△	◎	◎							TO220F-3	—	—	Foldback
SI-3003N	1.0				◎		◎	◎							TO220F-3	—	—	Current limiting
SI-3000F	1.0				◎	◎	◎	◎	◎	◎			◎		TO220F-5	—	○	Foldback
SI-3000KF	1.0	◎	△	◎	△	△	△	△			◎				TO220F-5	○	○	Foldback
SI-3001N	1.5				◎	◎	◎	◎		◎					TO220F-3	—	—	Foldback
SI-3000C	1.5			◎	◎	◎	◎	◎		◎					TO220F-5	—	○	Foldback* ⁴
SI-3000R	1.5				◎										TO220F-5	—	○	Current limiting
SI-3002N	2.0				◎	◎	◎	◎							TO220F-3	—	—	Foldback
SI-3000V	2.0				◎		◎	◎							TO3P	—	—	Foldback
SI-3000J	2.0				◎	◎	◎	◎							TO220F-5	—	○	Foldback
SI-3000ZF	3.0		◎	◎								◎			TO220F-5	○	○	Foldback

△ : Under development ◎ : Available
 *4: Current limiting for SI-3033C

Regulator IC

● Switching mode Regulator IC (built-in overcurrent and overheat protection circuits)

● Surface Mount Type

Series Name	Output current (A)	Output voltage (V)						Variable (ref. voltage) (V)			Withstand Voltage (V)	Package	Low consumption current at OFF	Output ON/OFF	Overcurrent protection characteristics
		2.5	3.3	5	9	12	15	1.0	1.1	1.3					
SAI	0.4				○	○					35	PS-4	—	—	Current limiting
	0.5		○	○											
SI-8000W	0.6		○	○							35	SOP-8	—	—	Foldback
SI-8000JD	1.5		○	○	○	○					43	TO263-5	○	○	Foldback
SI-8000SD	3.0		○	○							43	TO263-5	—	○	Current limiting
SPI-8000A	3.0							○			53	HSOP16	○	○	Foldback
SI-8000RD	3.0		△	○							30*	TO263-5	—	○	Current limiting

*: 21V for SI-8033RD

● Thru-hole Type

Series Name	Output current (A)	Output voltage (V)						Variable (ref. voltage) (V)			Withstand Voltage (V)	Package	Low consumption current at OFF	Output ON/OFF	Overcurrent protection characteristics
		2.5	3.3	5	9	12	15	1.0	1.5	2.55					
SI-8000E	0.6			○		○					43	TO220F-5	—	—	Current limiting
SI-8000JF	1.5	○	○		○	○			○		43	TO220F-5	○	○	Foldback
SI-8000GL	1.5			○				○			53	DIP8	○	○	Foldback
SI-8000S	3.0		○	○	○	○	○				43*	TO220F-5	—	○	Current limiting

*: 35V for SI-8033S

● Surface Mount & Sync Rectifier Control Type

Series Name	Oscillating frequency (kHz)	Output voltage (V)						Variable (ref. voltage) (V)			Withstand Voltage (V)	Package	Low consumption current at OFF	Output ON/OFF	Overcurrent protection characteristics
		2.5	3.3	5	9	12	15	1.0	1.1	1.3					
SI-8011NVS	250								○		25	SSOP-24	—	○	Foldback
SI-8511NVS	400								○		25	SSOP-24	—	○	Foldback

● Built-in Flywheel Diode (Schottky Barrier Diode) Type

Series Name	Output current (A)	Output voltage (V)						Variable (ref. voltage) (V)			Withstand Voltage (V)	Package	Low consumption current at OFF	Output ON/OFF	Overcurrent protection characteristics
		2.5	3.3	5	6.5	12	15	1.0	1.1	2.55					
STA810M	1.5				○						43	SIP-8	○	○	Foldback
STA820M	3.0		△	○							31	SIP-8	—	○	Foldback

● Dual Output Regulator IC

Part Number		Output voltage (V)	Output current (A)	Package	Regulator type	Built-in Functions			Low consumption current at OFF
						Overcurrent protection	Thermal Protection	ON/OFF control	
SDI02	ch1	5.0	0.5	PS-16	Dropper	Vo shutdown after operation	○	○	—
	ch2	5.0	0.5			Vo shutdown after operation	○	○	
SPI-8001TW	ch1	Variable (1.0 to 16V)	1.5	HSOP-16	Step-down switching	Foldback	○	○	○
	ch2	Variable (1.0 to 16V)	1.5			Foldback	○	○	
SPI-8002TW	ch1	Variable (1.0 to 24V)	1.5	HSOP-16	Step-down switching	Foldback	○	○	○
	ch2	Variable (1.0 to 24V)	1.5			Foldback	○	○	
SI-3002KWF	ch1	3.3	1.0	TO220F-5	Dropper	Foldback	○	○	—
	ch2	2.5	1.0			Foldback	○	○	
SI-3002KWD	ch1	3.3	1.0	TO263-5	Dropper	Foldback	○	○	—
	ch2	2.5	1.0			Foldback	○	○	
SI-3002KWM	ch1	3.3	1.0	TO252-5	Dropper	Foldback	○	○	—
	ch2	2.5	1.0			Foldback	○	○	
SI-3003KWF	ch1	2.5	1.0	TO220F-5	Dropper	Foldback	○	○	—
	ch2	1.8	1.0			Foldback	○	○	
SI-3003KWD	ch1	2.5	1.0	TO263-5	Dropper	Foldback	○	○	—
	ch2	1.8	1.0			Foldback	○	○	
SI-3003KWM	ch1	2.5	1.0	TO252-5	Dropper	Foldback	○	○	—
	ch2	1.8	1.0			Foldback	○	○	

Diode

●Rectifier Diode

Part Number	V _{RM} (V)	I _{F(AV)} (A)	Package	I _{FSM} (A)	T _j (°C)	T _{stg} (°C)	V _F (V) max	I _F (A)	I _R (μA)	I _R (H) (mA)	Ta (°C)	R _{th(j-l)} (°C/W)	Mass (g)
				50Hz Single Half Sine Wave					V _R =V _{RM} max	V _R =V _{RM} max			
RM 4AM	600	1.8(3.2)	Axial (φ6.5/φ1.4)	350	-40 to +150	0.92	3.5	10	50	100	8	1.2	
RBV-406		4.0	RBV-40	80	-40 to +150	1.10	2.0	10	100	100	5.0	4.05	

●Fast Recovery Diode

Part Number	V _{RM} (V)	I _{F(AV)} (A)	Package	I _{FSM} (A)	T _j (°C)	T _{stg} (°C)	V _F (V) max	I _F (A)	I _R (μA)	I _R (H) (mA)	Ta (°C)	t _{rr} ^① (ns)		t _{rr} ^② (ns)		R _{th(j-l)} (°C/W)	Mass (g)
				50Hz Single Half Sine Wave					V _R =V _{RM} max	V _R =V _{RM} max		I _F /I _{RP} (mA)	I _F /I _{RP} (mA)				
RU 3YX	100	2.0	Axial (φ4.0/φ0.98)	50	-40 to +150	0.95	2.0	10	300	100	0.2	10/10	0.08	10/20	12	0.6	
EU 1Z	200	0.25	Axial (φ2.7/φ0.78)	15	-40 to +150	2.5	0.25	10	150	100	0.4	10/10	0.18	10/20	17	0.3	
AL01Z		1.0	Axial (φ2.5/φ0.6)	25	-40 to +150	0.98	1.0	100	0.5	100	50	100/100	35	100/200	22	0.13	
FML-G12S		5.0	TO-220F2Pin	65	-40 to +150	0.98	5.0	250	1	100	40	100/100	30	100/200	4.0	2.1	
FMX-G12S			TO-220F2Pin	65	-40 to +150	0.98	5.0	100	20	100	30	100/100	25	100/200	4.0	2.1	
SPX-62S		6.0	Surface mount (D pack) Center-tap	80	-40 to +150	0.98	3.0	50	10	100	30	100/100	25	100/200	5.0	0.41	
FMX-G22S		10.0	TO-220F2Pin	150	-40 to +150	0.98	10.0	200	50	100	30	500/500	25	500/1000	4.0	2.1	
EU 2		400	1.0	Axial (φ2.7/φ0.78)	15	-40 to +150	1.4	1.0	10	300	100	0.4	10/10	0.18	10/20	17	0.3
SFPL-64	Surface mount (SFP)			25	-40 to +150	1.3	1.0	10	0.05	150	50	100/100	30	100/200	20	0.07	
FML-24S	10.0		TO-220F (Center-tap)	70	-40 to +150	1.3	5.0	100	0.2	100	50	100/100	35	100/200	4.0	2.1	
AG01A	600	0.5	Axial (φ2.5/φ0.6)	15	-40 to +150	1.8	0.5	100	0.5	100	100	100/100	50	100/200	22	0.13	
FMX-G16S		5.0	TO-220F2Pin	50	-40 to +150	1.5	5.0	50	15	150	30	100/100	25	100/200	4.0	2.1	
FMG-26S		6.0	TO-220F (Center-tap)	50	-40 to +150	2.2	3.0	500	3	100	100	100/100	50	100/200	4.0	2.1	
FMD-G26S		10.0	TO-220F2Pin	100	-40 to +150	1.7	10.0	100	0.3	100	50	500/500	30	500/1000	4.0	2.1	
FML-36S		20.0	FM80 (Center-tap)	100	-40 to +150	1.7	10.0	100	0.3	100	65	500/500	35	500/1000	2.0	5.5	

●Schottky Barrier Diode

Part Number	V _{RM} (V)	I _{F(AV)} (A)	Package	I _{FSM} (A)	T _j (°C)	T _{stg} (°C)	V _F (V) max	I _F (A)	I _R (μA)	I _R (H) (mA)	Ta (°C)	R _{th(j-l)} (°C/W)	Mass (g)
				50Hz Single Half Sine Wave					V _R =V _{RM} max	V _R =V _{RM} max			
EK 04	40	1.0	Axial (φ2.7/φ0.6)	40	-40 to +150	0.55	1.0	5	35	150	20	0.3	
SFPB-54			Surface mount (SFP)	30	-40 to +150	0.55	1.0	1	35	150	20	0.07	
EK 14		3.0	1.5	Axial (φ2.7/φ0.78)	40	-40 to +150	0.55	2.0	5	70	150	17	0.3
SFPB-64			2.0	Surface mount (SFP)	60	-40 to +150	0.55	2.0	5	70	150	20	0.07
SFPB-74			Surface mount (SFP)	60	-40 to +150	0.5	2.0	5	100	150	20	0.07	
SPB-G34S			Surface mount (D pack) Center-tap	50	-40 to +150	0.55	3.0	3.5	100	150	5	0.29	
SPB-G54S			Surface mount (D pack) Center-tap	60	-40 to +150	0.55	5.0	5	175	150	5	0.29	
SFPB-56	60	0.7	Surface mount (SFP)	10	-40 to +150	0.62	0.7	1	30	150	20	0.07	
EK 16	60	1.5	Axial (φ2.7/φ0.78)	25	-40 to +150	0.62	1.5	1	55	150	17	0.3	
RK 36			2.0	Axial (φ4.0/φ0.98)	40	-40 to +150	0.62	2.0	2	70	150	12	0.6
SFPB-76		Surface mount (SFP)		40	-40 to +150	0.62	2.0	2	70	150	20	0.07	
SPB-G56S		5.0	Surface mount (D pack) Center-tap	60	-40 to +150	0.7	5.0	3	125	150	5	0.29	
FME-2106		10	TO-220F (Center-tap)	60	-40 to +150	0.72	5.0	1	35	150	4	2.1	
FMW-2156		15	TO-220F (Center-tap)	100	-40 to +150	0.7	7.5	5	175	150	4	2.1	
FMB-2306		30	TO-220F (Center-tap)	150	-40 to +150	0.7	15	8	400	150	4	2.1	
FMB-36M	FM80 (Center-tap)		150	-40 to +150	0.62	15.0	10	525	150	2	5.5		
SFPB-69	90	1.5	Surface mount (SFP)	40	-40 to +150	0.81	1.5	2	55	150	20	0.07	
FMB-29L	100	8.0	TO-220F (Center-tap)	60	-40 to +150	0.81	4.0	5	125	150	4	2.1	
FME-220A		20	TO-220F (Center-tap)	120	-40 to +150	0.85	10	1	100	150	4	2.1	
FME-230A		30	TO-220F (Center-tap)	150	-40 to +150	0.85	15	1.5	150	150	4	2.1	

AC Adapter (SEA, SEB and SEC Series)

● Features

- Small-size switching AC adapter with large capacitance
- Circuitry with improved power factor. Complies with harmonic regulations (SEB100P2, SEC150P2, SEC165P2).
- Continuous input system accepted worldwide.
- Peak current (1.2 to 1.3 times the rated power).
- Conforms to the world standards:
UL1950, C-UL, TÜV (EN60950), Electrical Appliance and Material Safety Law (J60950), CE marking
- Reduced noise terminal voltage.
VCCI Class-2, FCC Class-B, EN55022
- Protection functions
Overcurrent protection (constant current Current limiting), and overvoltage and thermal protection

Application: Notebook PC, LCD monitor, LCD TV, office machine, information terminal equipment, portable measuring instrument, small-size printer, handheld equipment, etc.



● Specifications

SEA Series

Model	SEA40N2/N3				SEA60N2/N3	
	SEA40N*-12.0	SEA40N*-13.8	SEA40N*-16.0	SEA40N*-24.0	SEA60N*-12.0	SEA60N*-16.0
Rated input voltage	AC100–240V				AC100–240V	
Input voltage range	AC90 to 264V				AC90 to 264V	
Input current	0.8A max.				1.3A max.	
Power at no load	1 W max. (rated input)				1 W max. (rated input)	
Efficiency (typ)	81%	82%	83%	85%	81%	83%
Power factor	60%Typ (AC100V) / 43%Typ (AC240V)				–	
Inrush current	100A max. (at cold start)				100A max. (at cold start)	
Leakage current	120 μ A max (V_{IN} =240V 60Hz)				120 μ A max (V_{IN} =240V 60Hz)	
Output power (rated)	30W	35W	40W	40W	42W	53W
Output power (max.)	40W	45W	50W	50W	52W	70W
Rated output voltage	12.0V	13.8V	16.0V	24.0V	12.0V	16.0V
Rated output current	2.50A	2.50A	2.50A	1.67A	3.50A	3.36A
Output current range	0 to 3.33A	0 to 3.26A	0 to 3.13A	0 to 2.08A	0 to 4.37A	0 to 4.37A
Ripple noise	350mVp-p				350mVp-p	
Protection	Overcurrent protection (constant current), and overvoltage and thermal protection				Overcurrent protection (constant current), and overvoltage and thermal protection	
Dimensions	94 x 45 x 26 mm (220g max.)				114.5 x 49.5 x 27 mm (270g max.)	

AC Adapter

SEB Series

Model	SEB55N2		SEB80N2			SEB100N2		
	SEB55N2-16.0	SEB55N2-24.0	SEB80N2-16.0	SEB80N2-19.0	SEB80N2-24.0	SEB100N2-15.6	SEB100N2-19.0	SEB100N2-24.0
Rated input voltage	AC100–240V		AC100–240V			AC100–240V		
Input voltage range	AC90 to 264V		AC90 to 264V			AC90 to 264V		
Input current	0.9A max.		1.8A max.			1.2A max.		
Power at no load	0.8W max. (rated input)		0.8W max. (rated input)			0.5W max. (rated input)		
Efficiency (typ)	84%	87%	85%	86%	86%	85%	85%	85%
Inrush current	100A max. (at cold start)		60A max. (at cold start)			80A max. (at cold start)		
Output power (rated)	40W		60W			80W		
Output power (max.)	55W		80W			100W		
Rated output voltage	16.0V	24.0V	16.0V	19.0V	24.0V	15.6V	19.0V	24.0V
Rated output current	2.50A	1.67A	3.75A	3.16A	2.50A	5.00A	4.22A	3.33A
Output current range	0 to 3.44A	0 to 2.29A	0 to 5.00A	0 to 4.20A	0 to 3.33A	0 to 5.50A	0 to 5.27A	0 to 4.16A
Ripple noise	500mVp-p		350mVp-p			350mVp-p		
Protection	Overcurrent protection (constant current), and overvoltage and thermal protection		Overcurrent protection (constant current), and overvoltage and thermal protection			Overcurrent protection (constant current), and overvoltage and thermal protection		
Dimensions	83 x 39 x 27mm (200g max.)		127 x 51 x 28mm (250g max.)			140 x 56 x 28mm (400g max.)		

SEC Series

Model	SEC150P2		SEC165P2	
	SEC150P2-15		SEC165P2-19	SEC165P2-24
Rated input voltage	AC100–240V		AC100–240V	
Input voltage range	AC90 to 264V		AC90 to 264V	
Input current	1.7A max.		2.2A max.	
Power at no load	0.6W max. (rated input)		0.6W max. (rated input)	
Efficiency (typ)	85%		86%	86%
Power factor	0.8 min.		0.8 min.	
Inrush current	100A max. (at cold start)		100A max. (at cold start)	
Output power (rated)	120W		150W	
Output power (max.)	150W		175W	
Rated output voltage	15.0V		19.0V	24.0V
Rated output current	8.00A		7.90A	6.25A
Output current range	0 to 10.0A		0 to 9.2A	0 to 7.3A
Ripple noise	400mVp-p		350mVp-p	
Protection	Overcurrent protection (constant current), and overvoltage and thermal protection		Overcurrent protection (constant current), and overvoltage and thermal protection	
Dimensions	145 x 65 x 38mm (650g max.)		175 x 70 x 41mm (800g max.)	

●Website <http://www.sanken-ele.co.jp>

SANKEN ELECTRIC CO.,LTD.

ISO 9001/14001 Certified

Sanken products are manufactured and delivered to the customer based on a strict quality and environmental control system established and certified by the ISO 9001/14001 international certification standards.

1-11-1 Nishi-Ikebukuro, Toshima-ku, Tokyo
PHONE : 03-3986-6164 FAX : 03-3986-8637

■Products: Products: Power IC, Control IC, Hall IC, Bipolar Transistor, MOS FET, IGBT, Thyristor, Rectifier Diode, LED (Light Emitting Diode), CCFL (Cold Cathode Fluorescent Lamp), Switching Power Supply, UPS (Uninterruptible Power Supply), DC Power Supply, Inverter, Universal Airway Beacon System and Other Power Supplies and Equipments

●The information contained in this document is correct as of October 2005.

This is notification that you, as purchaser of the products/technology, are not allowed to perform any of the following:

1. Resell or retransfer these products/technology to any party intending to disturb international peace and security.
2. Use these products/technology yourself for activities disturbing international peace and security.
3. Allow any other party to use these products/technology for activities disturbing international peace and security.

Also, as purchaser of these products/technology, you agree to follow the procedures for the export or transfer of these products/technology, under the Foreign Exchange and Foreign Trade Law, when you export or transfer the products/technology abroad.



This document uses 100% recycled paper.

PRINTED in JAPAN H1-L04EC0-0510015TA