

# MASTECH®

## MS8253 Series

### DUAL DISPLAY DIGITAL MULTIMETER User's Manual

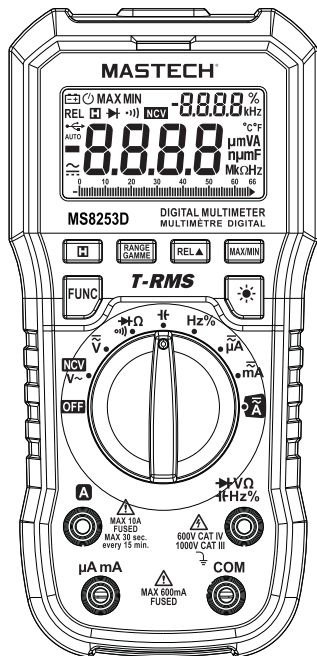

## 1. Safety Information



**Use caution and follow all safety guidelines to prevent electric shock or damage to the meter. Please read carefully all instructions before use. If the equipment is used in a manner not specified by the manufacturer, the protection provided by the equipment may be impaired.**

The multimeter meets the safety standards of EN/UL/CSA 61010-1, 61010-2-030, 61010-2-033 for electronic testing instruments. This meter meets CAT III 1000V, CAT IV 600V installations and a pollution degree of 2.











### 1.1 Preparation

- 1.1.1 When using the meter, follow all standard safety guidelines:
  - For universal protection against electric shock.
  - To prevent the misuse of the instrument.
- 1.1.2 Check the meter for damage during transit.
- 1.1.3 Test leads must be in good condition. Check the insulation and tips before use.
- 1.1.4 Safety can only be guaranteed with leads provided. If leads need to be replaced, they must be replaced with leads of same electrical specifications.

### 1.2 Using the Meter

- 1.2.1 Always set the meter to the proper function and range first.
- 1.2.2 Never exceed protection limits indicated for each measurement.
- 1.2.3 Keep fingers behind the probe barriers while measuring.
- 1.2.4 Always be careful when working with voltages above 60V DC or 30V AC RMS.
- 1.2.5 When using the CAT IV environment, if the measuring voltage between terminals and earth ground exceeds 600V CAT III environments or voltage measurement between the terminal and the earth more than 1000V, do not measure voltage.
- 1.2.6 In manual range, if the circuit value is unknown, start the meter at the maximum range and then adjust accordingly.
- 1.2.7 Remove the leads from the circuit first before switching between functions.
- 1.2.8 Do not power on circuit while measuring resistance, capacitance, diodes and continuity.
- 1.2.9 Never connect the meter's leads across a voltage source while the rotary switch is in the resistance, capacitance, diode or continuity mode.
- 1.2.10 Do not measure capacitance before capacitors are discharged.
- 1.2.11 Do not operate the meter near explosive gas, vapor or dust.
- 1.2.12 Stop using the meter if any abnormality is observed.
- 1.2.13 Do not use the meter unless the battery cover is securely fastened to the meter.
- 1.2.14 Avoid direct exposure to sunlight to ensure extended life of the meter.

## 1.3 Safety Symbols

	Important safety information.
	High voltage with danger.
	Ground.
	Double Insulation (Class II safety equipment).
	Fuse must be replaced as per the specification herein.
	AC (Alternating Current)
	DC (Alternating Current)
	AC & DC (Both direct and Alternating Current)
	Accord with the related EU laws and regulations
	Conforms to UL STD. 61010-1, 61010-2-030 and 61010-2-033; Certified to CSA STD. C22.2, NO. 61010-1, 61010-2-030 and 61010-2-033
<b>CAT III</b>	It is applicable to test and measuring circuits connected to the distribution part of the building's low-voltage MAINS installation.
<b>CAT IV</b>	It is applicable to test and measuring circuits connected at the source of the building's low-voltage MAINS installation.

## 1.4 Maintenance

- 1.4.1 To avoid electric shock or personal injury, repairs/ servicing not covered in this manual should be performed only by qualified personnel.
- 1.4.2 Remove test leads from any circuit before opening battery cover.
- 1.4.3 To avoid false readings that may become dangerous, replace the battery as soon as the  symbol appears.
- 1.4.4 Clean the meter using a damp cloth and mild detergent only; do not use abrasives or chemical solvents.

- 1.4.5 Always move rotary switch to OFF when not using the meter.
- 1.4.6 If meter is not going to be used for an extended period of time, remove battery to prevent damage to the meter.

## 2. Description

- The multimeter is a portable, hand-held yet professional meter that features True RMS measurement display, AC/DC current, AC/DC voltage, Frequency, Capacitance, Resistance, Continuity, Duty Ratio, Diode Testing and a USB adapter for recording readings on a PC. This Meter is easy to use even with one hand, suitable for professional users or amateurs, and ideal for school or home use.
- Both auto and manual range.
- Display hold
- True RMS for AC voltage/current measurements
- Relative measurement
- Maximum measurement
- Minimum measurement
- Display frequency when measuring AC voltage/current
- Automatic Power Off

## 2.1 Part Name

- (1) USB interface (Only for MS8253D)
- (2) NCV detection indicator
- (3) LCD display
- (4) Function buttons
- (5) Rotary switch
- (6) Input sockets
- (7) NCV detection sensor

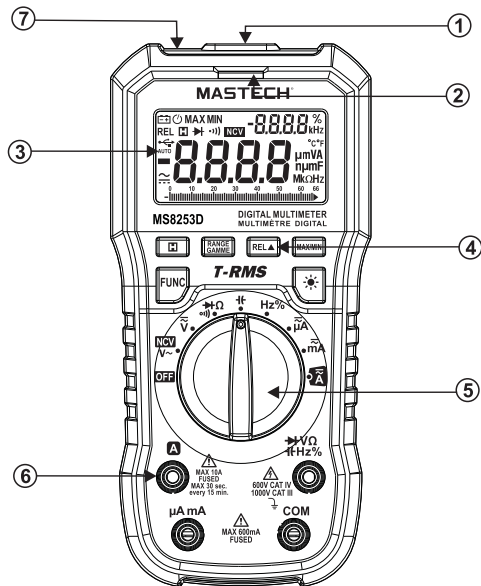

## 2.2 Buttons/Input jack description

- HOLD:** keep current reading on the display  
**FUNC:** switch between functions or AC/DC measurement  
**RANGE:** switch between auto/manual ranges  
**REL:** display relative measurement  
**MAX/MIN:** switch between max/min measurement display  
**☀:** :turn on/off backlight  
**OFF:**Power off position  
**VΩ:** :input jack for voltage, resistance, capacitance, diode, continuity  
**COM:**common terminal  
**μmA:**μA and mA current input terminal  
**A:**input jack for current measurement ( $\leq 10A$ )

## 2.3 LCD display

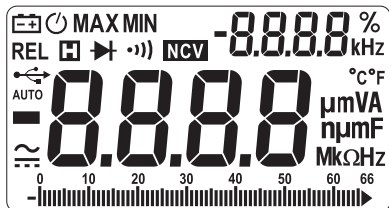

~	Alternating current
≡	Direct current
→	Diode
o))	Continuity
AUTO	Auto range
MAX	Maximum display
MIN	Minimum display
⏻	Auto power off
⊖	Low battery
%	Percentage (duty cycle)
Hz, kHz	Hertz, kilohertz (frequency)
mV, V	Millivolts, volts (voltage)
μA, mA, A	Micro amps, milliamps, amps (current)
nF, μF, mF	Nanofarad, microfarad, millifarad (capacitance)
Ω, kΩ, MΩ	Ohms, kilaohms, megaohms
REL	Relative display
NCV	Non-contact voltage detection
🔌	USB interface active (Only for MS8253D)

## 3. Specifications

Instrument should be calibrated annually at 18°C~28°C and relative humidity of <75%.

### 3.1 General Specifications

- 3.1.1 Auto and manual range
- 3.1.2 Full range overload protection
- 3.1.3 Max. voltage between terminal and ground:
  - CAT IV ,600V DC or AC rms.
  - CAT III ,1000V DC or AC rms
- 3.1.4 Operating altitude: 2000m max.
- 3.1.5 Display: LCD
- 3.1.6 Maximum display value:6599
- 3.1.7 Polarity indication: automatically displays “-”
- 3.1.8 Over range indication: “OL” or “-OL”
- 3.1.9 Sample rate: approx. 0.4s/analog bar graph: approx. 0.04s  
except for current measurement: approx. 1s/bar graph: 0.1s
- 3.1.10 Unit display: functions and unit power
- 3.1.11 Auto power off time: approx. 15 minutes.
- 3.1.12 Power supply: 9V battery
- 3.1.13 Low battery indication: display shows “⊖”
- 3.1.14 Temp. coefficient: less than 0.1 x accuracy/°C
- 3.1.15 Operating temperature: 0~40°C
- 3.1.16 Storage temperature: -10~50°C
- 3.1.17 Dimensions: 180x86x52mm
- 3.1.18 Weight: approx. 250g (without battery)

## 3.2 Technical Indicators

### 3.2.1 True RMS characteristics

- 3.2.1.1 For non-sinusoidal signal measurement, the Meter provides more accurate measurement than the traditional averaging method.
- 3.2.1.2 If in AC current mode, the Meter may display a random reading between 1 and 50 when the input is not active. This will not affect the accuracy of measurement.
- 3.2.1.3 True RMS requires a minimum input level, AC current or voltage should be 2%~100% of the maximum level.

### 3.2.2 DC Voltage

Range	Resolution	Accuracy
660mV	0.1mV	±(0.8% of reading + 3 digits)
6.6V	0.001V	±(0.5% of reading + 5 digits)
66V	0.01V	
660V	0.1V	
1000V	1V	

- Input impedance: 10MΩ
- Overload protection: 660mV range: 250V DC or AC rms. 6.6V-1000V ranges: 1000V DC or 1000V AC rms.
- Max. input voltage: 1000V DC

### 3.2.3 AC Voltage

Range	Resolution	Accuracy
660mV	0.1mV	±(1.5% reading + 5 digits)
6.6V	0.001V	±(1.2% reading + 5 digits)
66V	0.01V	
660V	0.1V	±(1.0% reading + 3 digits)
1000V	1V	

- Input impedance: 10MΩ
- Overload protection: 660mV range: 250V DC or AC rms. 6.6V-1000V ranges: 1000V DC or 1000V AC rms.
- Max. input voltage: 1000V AC
- Frequency response: 50 ~ 60Hz
- Response: True RMS

### 3.2.4 Resistance

Range	Resolution	Accuracy
660Ω	0.1Ω	±(0.8% reading + 5 digits)
6.6kΩ	0.001kΩ	
66kΩ	0.01kΩ	
660kΩ	0.1kΩ	
6.6MΩ	0.001MΩ	
66MΩ	0.01MΩ	±(1.5% reading + 5 digits)

- Open circuit voltage: approx. 1.0V
- Overload protection: 250V DC or AC rms.

## 3.2.5 Capacitance

Range	Resolution	Accuracy
6.6nF	0.001nF	±(4.0% reading + 5 digits)
66nF	0.01nF	
660nF	0.1nF	
6.6μF	0.001μF	±(3.0% reading + 3 digits)
66μF	0.01μF	
660μF	0.1μF	
6.6mF	0.001mF	±(4.0% reading + 5 digits)
66mF	0.01mF	

- Overload protection: 250V DC or AC (RMS)

## 3.2.6 Diode Test

Range	Resolution	Function
	0.001V	Display approximate diode forward voltage value

- Forward DC current: approx. 1mA
- Reverse DC voltage: approx. 3.2V
- Overload protection: 250V DC or AC rms.

## 3.2.7 Circuit Continuity Test

Range	Resolution	Function
	0.1Ω	If the resistance of circuit to be measured is less than 50Ω, the meter's built-in buzzer will sound.

- Open circuit voltage is about 1.0V
- Overload protection: 250V DC or AC (RMS)

## 3.2.8 Frequency

### 3.2.8.1 In V mode:

Range	Resolution	Accuracy
66Hz	0.01Hz	±(1.5% reading + 5 digits)
660Hz	0.1Hz	
6.6kHz	0.001kHz	
66kHz	0.01kHz	
660kHz	0.1kHz	

- Frequency range: 10Hz~10kHz
- Input voltage range: ≥0.2V AC(rms)(as measured frequency increases, voltage will also increase)

### 3.2.8.2 Pass Hz grade:

Range	Resolution	Accuracy
66Hz	0.01Hz	±(1.5% reading + 5 digits)
660Hz	0.1Hz	
6.6kHz	0.001kHz	
66kHz	0.01kHz	
660kHz	0.1kHz	
6.6MHz	1kHz	
66MHz	10kHz	

- Overload protection: 250V DC or AC rms.
- Measurement signal: Vpp=3V AC

### 3.2.8.3 Duty Ratio

Range	Resolution	Accuracy
1.0-99.9%	0.1%	±2.0%

## 3.2.9 DC Current

Range	Resolution	Accuracy
660μA	0.1μA	±(1.0% reading + 5 digits)
6600μA	1μA	
66mA	10μA	
660mA	100μA	
10A	10mA	±(2.0% reading + 5 digits)

- Overload protection:

μA/mA jack: FF 600mA/1000V. A jack: FF 10A/1000V.

- When measuring current larger than 5A, do not continue measurement for greater than 10s. Wait 1 min. after measurement before resuming.

## 3.2.10 AC Current

Range	Resolution	Accuracy
660μA	0.1μA	±(1.5% reading + 5 digits)
6600μA	1μA	
66mA	10μA	
660mA	100μA	
10A	10mA	±(3.0% reading + 5 digits)

- Overload protection:

μA/mA jack: FF 600mA/1000V. A jack: FF 10A/1000V.

- Frequency response: 50 ~ 60Hz

- Response: True RMS

- When measuring current larger than 5A, do not continue measurement for greater than 10s. Wait 1 min. after measurement before resuming.

## 4. Using the Meter

### 4.1 Data Hold

4.1.1 During measurement, if you want to keep the reading on the display, press "**HOLD**" and the reading will be held.

4.1.2 Press "**HOLD**" again to release the hold.

### 4.2 Manual Range

4.2.1 In voltage, current, resistance, capacitance, and frequency modes, the default range is auto.

4.2.2 Press "**RANGE**" to switch to manual range. Each press of the button increases the range, and returns to the lowest range when pressed in the largest range.

4.2.3 Hold down "**RANGE**" for 1 second to return to auto range.

4.2.4 When in Max/Min modes, pressing "**RANGE**" to return to normal measurement.

#### Note:

Frequency cannot be set to manual range.

### 4.3 Relative Mode

4.3.1 Press "**REL**" to enter relative mode. The meter stores the measured value when the button was pressed and compares it to the currently measured value (rel = current reading - stored reading).

### 4.4 Maximum/Minimum Mode

4.4.1 Press "**MAX/MIN**" in any range to show the maximum value recorded; press "**MAX/MIN**" again to show the minimum value recorded; press "**MAX/MIN**" a third time to return the display to normal.



## 4.5 Function Switch

- 4.5.1 In voltage and current modes, press“**FUNC**”to switch between AC and DC modes.
- 4.5.2 In the multi-function position, press“**FUNC**”to switch between resistance, diode and continuity modes.

## 4.6 Backlight

- 4.6.1 Press “” key, turn on or off backlight.

## 4.7 Auto Power Off

- 4.7.1 If the meter is not used for 15 minutes, the meter will automatically turn itself off to save battery power.
- 4.7.2 To turn the meter back on, press any button.
- 4.7.3 Holding “**FUNC**”when turning on the meter will disable auto power off.

## 4.8 USB Communication (Only for MS8253D)

- 4.8.1 Install the included software and USB driver ( See PC CD-ROM software user’s guide) on a PC.
- 4.8.2 Use the included USB cable to connect the meter to the PC; the  symbol appears on the display.
- 4.8.3 Open the installed software and the meter will begin sending the measured data to the software.

## 4.9 NCV (Non-Contact Voltage detection)

- 4.9.1 Move the rotary switch to the NCV position.
- 4.9.2 Move the NCV sensor (top of the meter) toward the object to be tested. If the sensor detects voltage greater than 110VAC (rms), the NCV indicator will flash and the meter will beep.

## Note:

1. Even without indication, voltage may still exist. Do not solely rely on NCV detection to determine in voltage exists. Detection may be affected by socket design, insulation thickness or other factors.
2. NCV indicator may go off when measuring voltage due to the presence of induced voltage.
3. Interference sources may accidentally trigger NCV detector.

## 4.10 DC/AC Voltage

Voltage is the potential difference between two points. The polarity of AC voltage changes over time where DC voltage polarity does not.  
DC voltage ranges: 660.0mV、6.600V、66.00V、660.0V、1000V .AC voltage ranges: 660mV、6.600V、66.00V、660.0V、1000V. 660.0mV range can only be entered through manual range.

Measuring DC/AC voltage:

- 4.10.1 Move the rotary switch to the  position.
- 4.10.2 Connect the red test lead to the V jack and the black lead to the COM jack.
- 4.10.3 Connect the leads in parallel with the circuit under test.
- 4.10.4 The measured voltage will be displayed. For DC measurement, the polarity of the red lead will be indicated.
- 4.10.5 Press“**FUNC**” to switch between DC and AC voltage.

## 4.11 Resistance

Resistance ranges: 660.0 $\Omega$ 、6.600k $\Omega$ 、66.00k $\Omega$ 、660.0k $\Omega$ 、6.600M $\Omega$ 、66.00M $\Omega$ .

To measure resistance:

- 4.11.1 Move rotary switch to the   $\Omega$  position.
- 4.11.2 Connect the red test lead to the  $\Omega$  jack and the black lead to the COM jack.
- 4.11.3 Connect leads to circuit under test.
- 4.11.4 The measured resistance will be displayed.

## 4.12 Continuity

While in resistance mode, press “FUNC” to switch to continuity mode.

- 4.12.1 Connect the red test lead to the  $\Omega$  jack and the black lead to the COM jack
- 4.12.2 Connect leads to circuit under test.
- 4.12.3 If the measured resistance is less than 50 $\Omega$ , the meter’s buzzer will sound.

## 4.13 Diode Test



While in continuity mode, press “FUNC” to switch to diode mode.

- 4.13.1 Connect the red test lead to the V jack and the black lead to the COM jack.
- 4.13.2 Connect leads across the diode under test.
- 4.13.3 The display shows the approx. forward voltage drop.

## 4.14 Capacitance

Capacitance ranges: 6.600nF、66.00nF、660.0nF、6.600 $\mu$ F、66.00 $\mu$ F、660.0 $\mu$ F、6.600mF and 66.00mF.

Measuring capacitance:

- 4.14.1 Move the rotary switch to the  position.
- 4.14.2 Connect the red test lead to the  jack and the black lead to the COM jack.
- 4.14.3 Connect the leads across the capacitor for measurement
- 4.14.4 The measured capacitance will be displayed

## 4.15 Frequency and Duty Cycle

Frequency ranges: 66.00Hz、660.0Hz、6.600kHz、66.00kHz、660.0kHz、6.600MHzV、66.00MHz.

Measuring Frequency:

- 4.15.1 Move the rotary switch to the Hz% position.
- 4.15.2 Connect the red test lead to the Hz% jack and the black lead to the COM jack.
- 4.15.3 Connect the leads across the circuit under test.
- 4.15.4 The measured frequency will be displayed.
- 4.15.5 Press “FUNC” to switch to duty cycle.
- 4.15.6 Repeat steps 2-4 to measure duty cycle.

## 4.16 DC/AC Current

Current ranges: 660.0 $\mu$ A、6600 $\mu$ A、66.00mA、660.0mA、10.00A.

- 4.16.1 Turn off power to the circuit and discharge all capacitors fully.
- 4.16.2 Move the rotary switch to the appropriate current position ( $\mu$ A, mA, or A)
- 4.16.3 Connect the black test lead to the COM jack. If the current to be measured is less than 600mA, connect the red test lead to the  $\mu$ mA jack. If the current to be measured is between 600mA and 10A, connect the red test lead to the A jack.

- 4.16.4 Connect the leads in series to the circuit under test (break circuit and connect red lead to the relatively higher voltage side and black lead to relatively lower voltage side).
- 4.16.5 Turn power back on to circuit and the measured current will be displayed. If the display shows "OL", it means the current exceeds the selected range; move the rotary switch to the next highest range.

## 5. Maintenance

### 5.1 Replacing the Battery and Fuse

**⚠ WARNING**

**To avoid electrical shock or personal injury, before opening the battery cover to replace battery, you should turn the meter off and make sure that the test probe is disconnected from the measurement circuit.**

To avoid wrong readings, electric shock or personal injury, when "⚡" appears on the meter display, replace the battery immediately.

Use only a fuse with specified amperage, fusing rated value, voltage rated value and fusing speed (F1:FF 600mA H 1000V, F2:FF 10A H 1000V)

Please follow below steps to replace battery or fuse:

- 5.1.1. Turn off the power supply of the meter.
- 5.1.2. Pull out all test probes from the input socket.
- 5.1.3. Loosen two screws on the fixed battery cover with screwdriver.
- 5.1.4. Remove the battery cover.
- 5.1.5. Remove the old battery or damaged fuse.

- 5.1.6. Replace with a new battery with 9V (NEDA 1604, 6F22 or 006P ) or a new fuse.
- 5.1.7. Replace the battery cover and tighten the screws.

**Note:**

Pay attention to the polarity of the battery to avoid damage to the meter

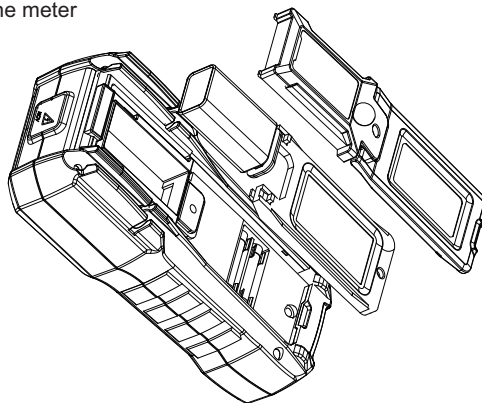

### 5.2 Replacing Test Probe

If insulation on leads is damaged, replace it.

**⚠ WARNING**

**If the test leads need to be replaced, you must use a new one which should meet EN 61010-031 standard, rated CAT III 1000V / CAT IV 600V, 10A or better.**

## 6. Accessories

1)	Test leads		1Pair
2)	Manual		1pcs
3)	Battery	9V 6F22	1pcs
4)	USB interface cable (Only for MS8253D)		1pcs
5)	USB interface software (Only for MS8253D)	CD ROM disc	1pcs

