

# LM1837 Low Noise Preamplifier for Autoreversing Tape Playback Systems

## General Description

The LM1837 is a dual autoreversing high gain tape preamplifier for applications requiring optimum noise performance. It has forward (left, right) and reverse (left, right) inputs which are selectable through a high impedance logic pin. It is an ideal choice for a tape playback amplifier when a combination of low noise, autoreversing, good power supply rejection, and no power-up transients are desired. The application also provides transient-free muting with a single pole grounding switch.

## Features

- Programmable turn-on delay
- Transient-free power-up—no pops
- Transient-free muting

- Low noise—0.6  $\mu\text{V}$  CCIR/ARM in a DIN circuit referenced to 1 kHz
- Low voltage battery operation —4V
- Wide gain bandwidth due to broadband two-amplifier approach—76 dB @ 20 kHz
- High power supply rejection—95 dB
- Low distortion—0.03%
- Fast slew rate—6V/ $\mu\text{s}$
- Short circuit protection
- Internal diodes for diode switching applications
- Low cost external parts
- Excellent low frequency response
- Prevents "click" from being recorded onto the tape during power supply cycling in tape playback applications
- High impedance logic pin for forward/reverse switching

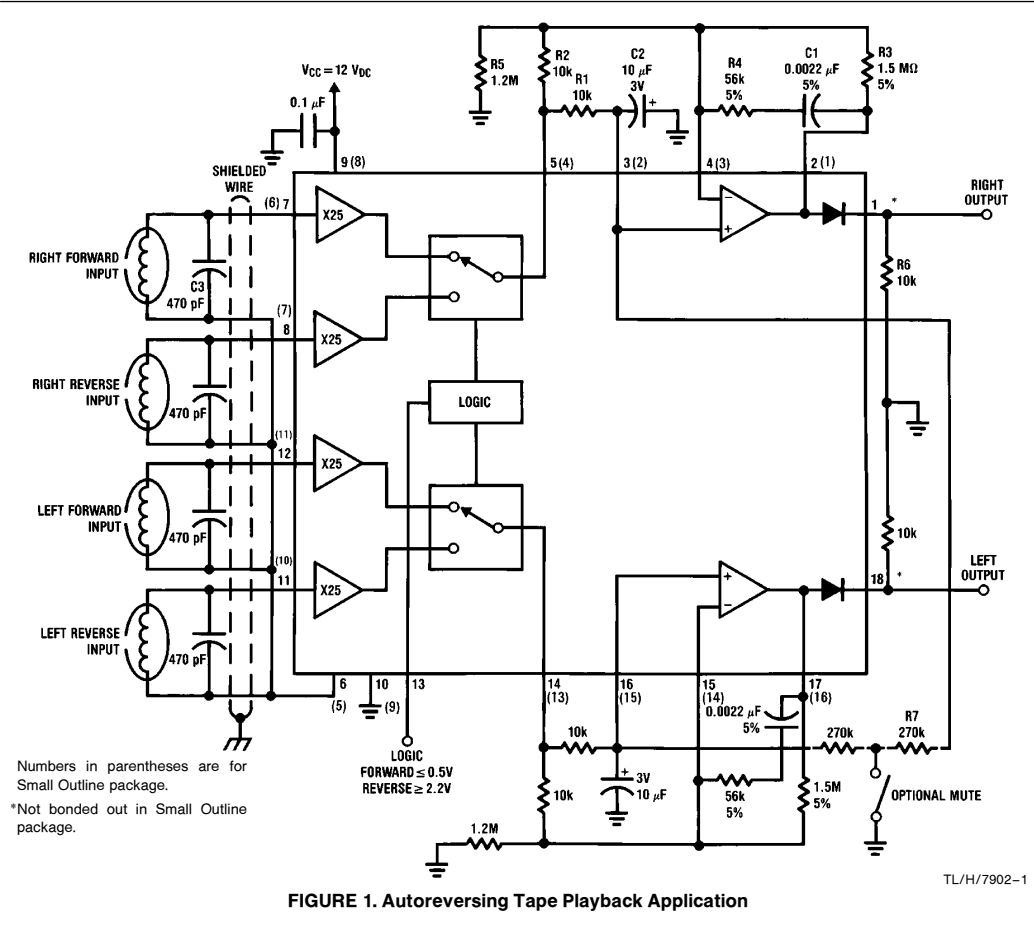

LM1837 Low Noise Preamplifier for Autoreversing Tape Playback Systems

## Absolute Maximum Ratings

If Military/Aerospace specified devices are required, please contact the National Semiconductor Sales Office/Distributors for availability and specifications.

Supply Voltage	18V
Voltage on Pins 1 and 18	18V
Package Dissipation (Note 1)	1390 mW
Storage Temperature	-65°C to +150°C
Operating Temperature	0°C to +70°C
Minimum Voltage on Any Pin	-0.1 V <sub>DC</sub>

### Soldering Information

Dual-In-Line Package	
Soldering (10 seconds)	260°C
Small Outline Package	
Vapor Phase (60 seconds)	215°C
Infrared (15 seconds)	220°C

See AN-450 "Surface Mounting Methods and Their Effect on Product Reliability" for other methods of soldering surface mount devices.

## Electrical Characteristics (T<sub>A</sub> = 25°C, V<sub>CC</sub> = 12V, see Test Circuit, Figure 2)

Parameter	Conditions	Min	Typ	Max	Units
Operating Supply Voltage Range	R5 Removed from Circuit for Low Voltage Operation	4		18	V
Supply Current	V <sub>CC</sub> = 12V		9	15	mA
Total Harmonic Distortion	f = 1 kHz, V <sub>IN</sub> = 0.3 mV, Pins 2 and 17, Figure 2		0.03		%
THD + Noise (Note 2)	f = 1 kHz, V <sub>OUT</sub> = 1V, Pins 2 and 17, Figure 2		0.10	0.25	%
Power Supply Rejection	Input Ref. f = 1 kHz, 1 Vrms	80	95		dB
Channel Separation (Note 3)	f = 1 kHz, Output = 1 Vrms,				dB
Left to Right	Output to Output	40	60		dB
Forward to Reverse		40	60		dB
Signal-to-Noise (Note 4)	Unweighted 32 Hz-12.74 kHz (Note 2)		58		dB
	CCIR/ ARM (Note 5)		62		dB
	A Weighted		64		dB
	CCIR, Peak (Note 6)		52		dB
Noise	Output Voltage CCIR/ ARM (Note 5)		120	200	μV
Input Amplifiers					
Input Bias Current	f = 1 kHz		0.5	2.0	μA
Input Impedance		150			kΩ
AC Gain		27	28	29	dB
AC Gain Imbalance			±0.15	±0.5	dB
DC Output Voltage		2.1	2.5	2.9	V
DC Output Voltage Mismatch	Pins 5 and 14	-200	±30	200	mV
Output Source Current	Pins 5 and 14	2	10		mA
Output Sink Current	Pins 5 and 14	300	600		μA
Logic Level					
Forward				0.5	V
Reverse		2.2			V
Logic Pin Current			2	6	μA
DC Voltage Change at Pins 5 and 14	Change Logic State	-100	±20	100	mV

## Electrical Characteristics ( $T_A = 25^\circ\text{C}$ , $V_{CC} = 12\text{V}$ , see Test Circuit, *Figure 2*) (Continued)

Parameter	Conditions	Min	Typ	Max	Units
Output Amplifiers					
Closed Loop Gain	Stable Operation	5			V/V
Open Loop Voltage Gain	DC		100		dB
Gain Bandwidth Product			5		MHz
Slew Rate			6		V/ $\mu\text{s}$
Input Offset Voltage			2	5	mV
Input Offset Current			20	100	nA
Input Bias Current			250	500	nA
Output Source Current	Pin 2 or 17	2	10		mA
Output Sink Current	Pin 2 or 17	400	900		$\mu\text{A}$
Output Voltage Swing	Pin 2 or 17		11		V <sub>p-p</sub>
Output Diode Leakage	Voltage on Pins 1 and 18 = 18V		0	10	$\mu\text{A}$

**Note 1:** For operation in ambient temperatures above  $25^\circ\text{C}$ , the device must be derated based on a  $150^\circ\text{C}$  maximum junction temperature and a thermal resistance of  $90^\circ\text{C}/\text{W}$  junction to ambient (Dual-In-Line). Small Outline Thermal Resistance is  $100^\circ\text{C}/\text{W}$ .

**Note 2:** Measured with an average responding voltmeter using the filter circuit in *Figure 4*. This simple filter is approximately equivalent to a "brick wall" filter with a passband of 20 Hz to 20 kHz (see Application Hints). For 1 kHz THD the 400 Hz high pass filter on the distortion analyzer is used.

**Note 3:** Channel separation can be measured by applying the input signal through transformers to simulate a floating source (see Application Hints). Care must be taken to shield the coils from extraneous signals. Actual production test techniques at National simulate this floating source with a more complex op amp circuit.

**Note 4:** The numbers are referred to an output level of 160 mV at pins 2 and 17 using the circuit of *Figure 2*. This corresponds to an input level of 0.3 mV<sub>rms</sub> at 333 Hz.

**Note 5:** Measured with an average responding voltmeter using the Dolby lab's standard CCIR filter having a unity gain reference at 2 kHz.

**Note 6:** Measured using the Rhode-Schwarz psophometer, model UPGR.

# Typical Performance Characteristics

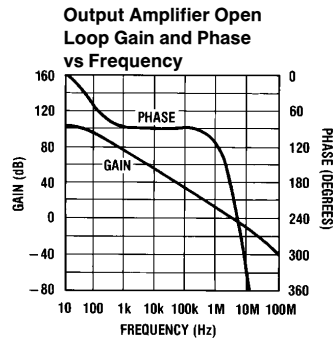
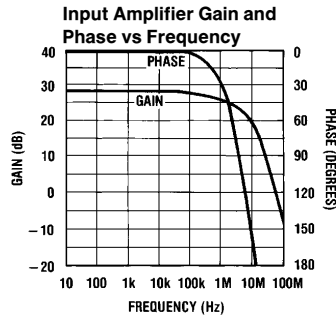
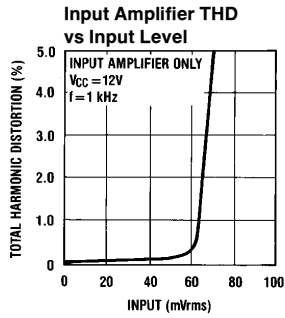

TL/H/7902-2

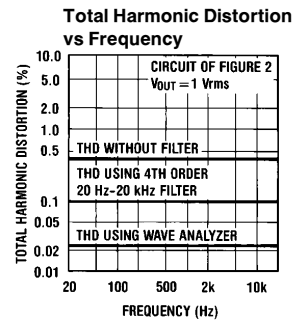
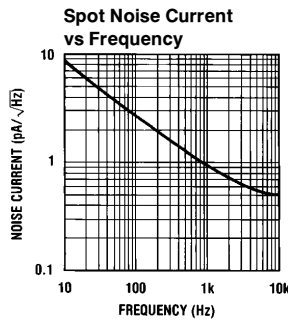
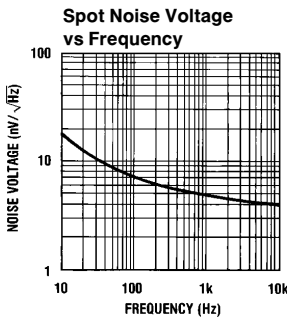

TL/H/7902-3

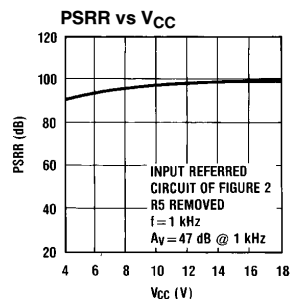
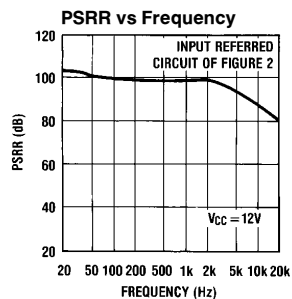
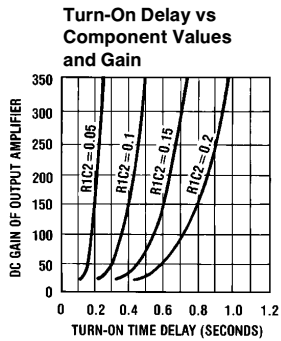

TL/H/7902-4

## Typical Performance Characteristics (Continued)

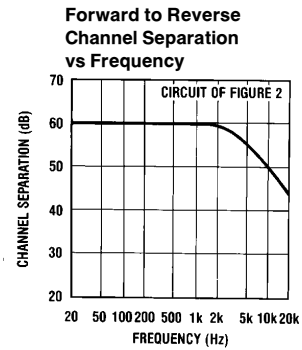
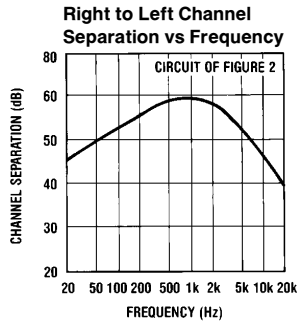
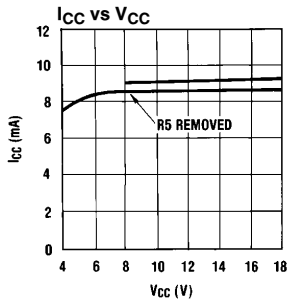

TL/H/7902-5

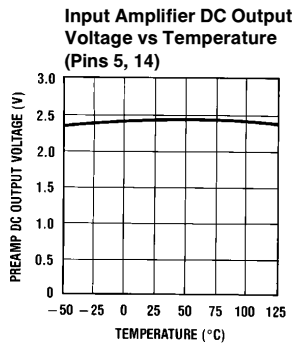

TL/H/7902-6

## Connection Diagrams

**Small Outline Package**

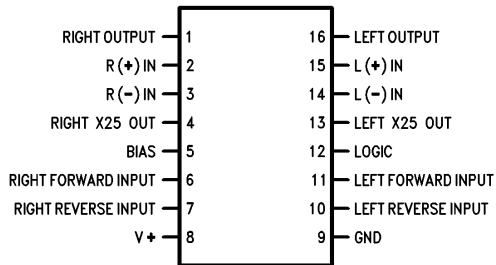

TL/H/7902-7

**Order Number LM1837M**  
See NS Package Number M16B

**Dual-In-Line Package**

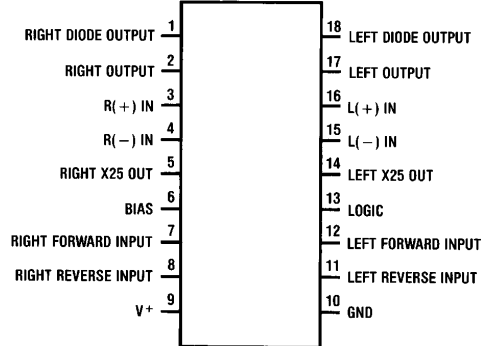

TL/H/7902-8

**Top View**

**Order Number LM1837N**  
See NS Package Number N18A

## External Components *(Figure 1)*

Component	Normal Range of Value and Function	Component	Normal Range of Value and Function
R1, C2	2 k $\Omega$ –40 k $\Omega$ , 0.1 $\mu$ F–10 $\mu$ F (low leakage) Set turn-on delay and second amplifier's low frequency pole. Leakage current in C2 results in DC offset between the amplifier's inputs and therefore this current should be kept low. R1 is set equal to R2 such that any input offset voltage due to bias current is effectively cancelled. An input offset voltage is generated by the input offset current multiplied by the value of these resistors.	R6	2 k $\Omega$ –47 k $\Omega$ Biases the output diode when it is used in DC switching applications. This resistor can be excluded if diode switching is not desired.
R2, R3	2 k $\Omega$ –40 k $\Omega$ , 500 k $\Omega$ –10 M $\Omega$ Sets the DC and low frequency gain of the output amplifier. The total input offset voltage will also be multiplied by the DC gain of this amplifier. It is therefore essential to keep the input offset voltage specification in mind when employing high DC gain in the output amplifier; i.e., 5 mV $\times$ 400 = 2V offset at the output.	C3	100 pF–1000 pF Often used to resonate with tape head in order to compensate for tape play-back losses including tape head gap and eddy current. For a typical cassette tape head, the resonant frequency selected is usually between 13 kHz and 17 kHz.
R4, C1	10 k $\Omega$ –200 k $\Omega$ , 0.00047 $\mu$ F–0.01 $\mu$ F Set tape playback equalization characteristics in conjunction with R3 (calculations for the component values are included in the Application Hints section).	R5	100 k $\Omega$ –10 M $\Omega$ Increases the output DC bias voltage from the nominal 2.5V value (see Application Hints).
		R7	Optionally used for tape muting. The use of this resistor can also provide "no-pop" turn-off if desired (see Application Hints).

## Simplified Schematic

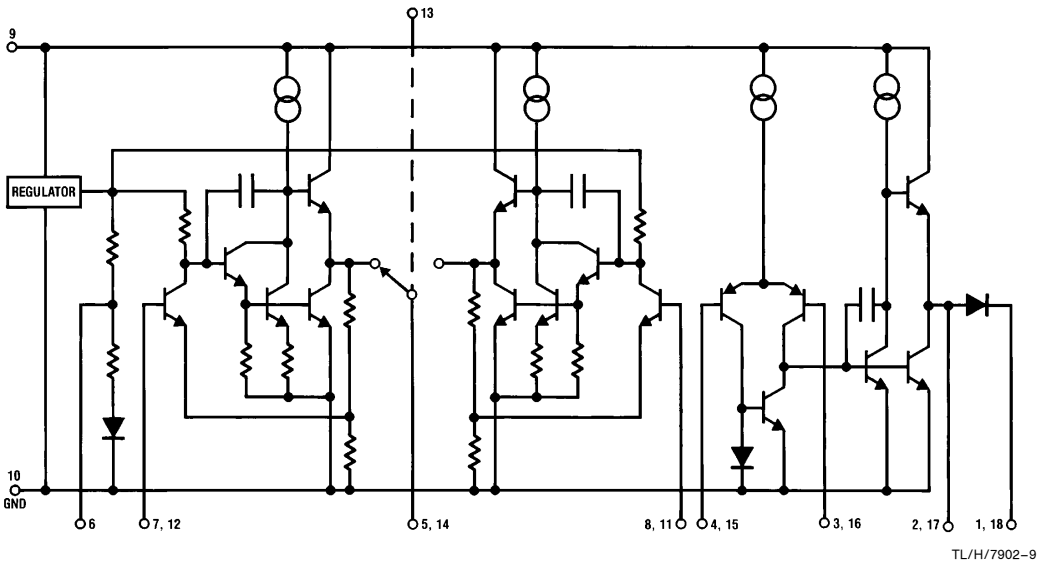

# Application Hints

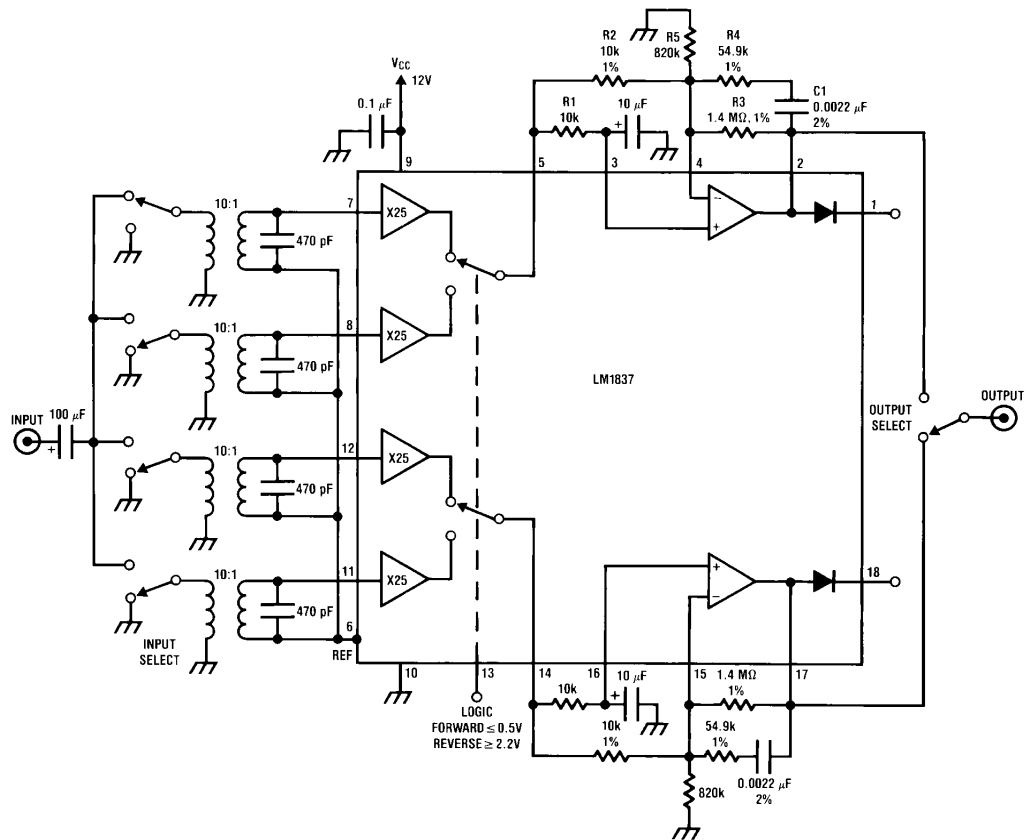

FIGURE 2. General Test Circuit

TL/H/7902-10

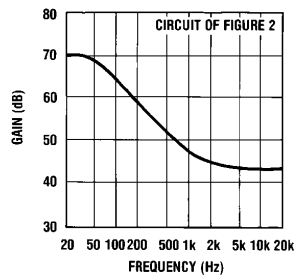

FIGURE 3. Frequency Response of Test Circuit

TL/H/7902-11

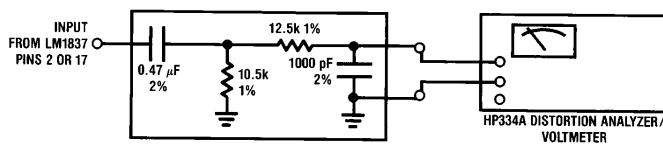

FIGURE 4. Simple 32 Hz-12740 Hz Filter and Meter

TL/H/7902-12

## Application Hints (Continued)

### DISTORTION MEASUREMENT METHOD

In order to clearly interpret and compare specifications and measurements for low noise preamplifiers, it is necessary to understand several basic concepts of noise. An obvious example is the measurement of total harmonic distortion at very low input signal levels. Distortion analyzers provide outputs which allow viewing of the distortion products on an oscilloscope. The oscilloscope often reveals that the “distortion” being measured contains 1) distortion, 2) noise, and 3) 50 or 60 cycle AC line hum.

Line hum can be detected by using the “line sync” on the oscilloscope (horizontal sync selector). The triggering of a constant waveform indicates that AC line pick-up is present. This is usually the result of electro-magnetic coupling into the preamplifier’s input or improper test equipment grounding, which simply must be eliminated before making further measurements!

Input coupling problems can usually be corrected by any one of the following solutions: 1) shielding the source of the magnetic field (using mu metal or steel), 2) magnetically shielding the preamplifier, 3) physically moving the preamplifier far enough away from the magnetic field, or 4) using a high pass filter ( $f_o = 200 \text{ Hz} - 1 \text{ kHz}$ ) at the output of the preamplifier to prevent any line signal from entering the distortion analyzer. Ground loop problems can be solved by rearranging ground connections of the circuit and test equipment.

Separating noise from distortion products is necessary when it is desired to find the actual distortion and not the signal-to-noise ratio of an amplifier. The distortion produced by the LM1837 is predominantly a second harmonic. It is for this reason that the third and higher order harmonics can be filtered without resulting in any appreciable error in the measurement. The filter also reduces the amount of noise in the measured data. Another more tedious technique for measuring THD is to use a wave analyzer. Each harmonic is measured and then summed in an rms calculation. A typical curve is plotted for distortion vs frequency using this method. A typical curve is also included using a 20 Hz to 20 kHz 4th order filter.

To specify the distortion of the LM1837 accurately and also not require unusual or tedious measurements the following method is used. The output level is set to 1 Vrms at 1 kHz (approximately 5 mV at the input). The output is filtered with the circuit of *Figure 4* to limit the bandwidth of the noise and measured with a standard distortion analyzer. The analyzer has a filter that is switched in to remove line hum and ground loop pick-up as well as unrelated low frequency noise. The resulting measurement is fast and accurate.

### SIGNAL-TO-NOISE RATIO

In the measurement of the signal-to-noise ratio, misinterpretations of the numbers actually measured are common. One amplifier may sound much quieter than another, but due to improper testing techniques, they appear equal in measurements. This is often the case when comparing integrated circuit to discrete preamplifier designs. Discrete transistor preamps often “run out of gain” at high frequencies and therefore have small bandwidths to noise as indicated in *Figure 5*.

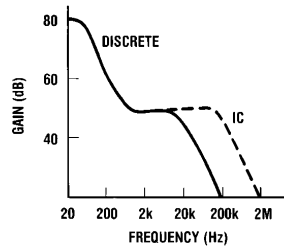

TL/H/7902-13

FIGURE 5

Integrated circuits have additional open loop gain allowing additional feedback loop gain in order to lower harmonic distortion and improve frequency response. It is this additional bandwidth that can lead to erroneous signal-to-noise measurements if not considered during the measurement process. In the typical example above, the difference in bandwidth appears small on a log scale but the factor of 10 in bandwidth (200 kHz to 2 MHz) can result in a 10 dB theoretical difference in the signal-to-noise ratio (white noise is proportional to the square root of the bandwidth in a system).

In comparing audio amplifiers it is necessary to measure the magnitude of noise in the audible bandwidth by using a “weighting” filter.<sup>1</sup> A “weighting” filter alters the frequency response in order to compensate for the average human ear’s sensitivity to certain undesirable frequency spectra. The weighting filters at the same time provide the bandwidth limiting as discussed in the previous paragraph.

The 32 Hz to 12740 Hz filter shown in *Figure 4* is a simple two pole, one zero filter, approximately equivalent to a “brick wall” filter of 20 Hz to 20 kHz. This approximation is absolutely valid if the noise has a flat energy spectrum over the frequencies involved. In other words a measurement of a noise source with constant spectral density through either of the two filters would result in the same reading. The output frequency response of the two filters is shown in *Figure 6*.



## Application Hints (Continued)

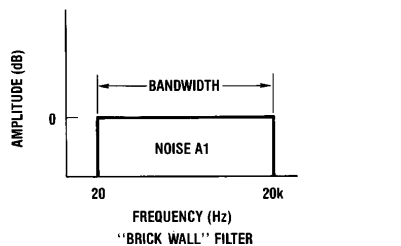

TL/H/7902-14

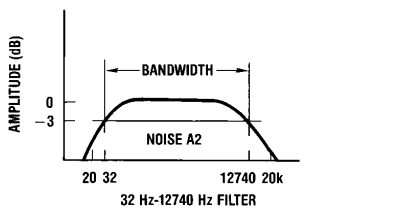

TL/H/7902-15

**FIGURE 6**

Typical signal-to-noise figures are listed for several weighting filters which are commonly used in the measurement of noise. The shape of all weighting filters is similar with the peak of the curve usually occurring in the 3 kHz–7 kHz region as shown in *Figure 7*.

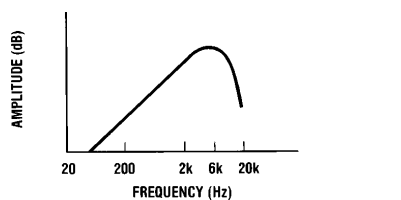

TL/H/7902-16

**FIGURE 7**

In addition to noise filtering, differing meter types give different noise readings. Meter responses include: 1) rms reading, 2) average responding, 3) peak reading, and 4) quasi peak reading. Although theoretical noise analysis is derived using true rms (root mean square) based calculations, most actual measurement is taken with ARM (Average Responding Meter) test equipment.

Unless otherwise noted an average responding meter is used for all AC measurements in this data sheet.

## BASIC CIRCUIT APPROACH

The LM1837 IC incorporates a two stage broadband design which minimizes noise, attains overall DC stability and prevents audible transients during turn-on.

The first stage consists of four direct coupled preamplifiers with internal gain of 25V/V (28 dB). Direct coupling to the tape head reduces input source impedance and external component cost by removing the input coupling capacitor. A typical input coupling capacitor of 1  $\mu$ F has a reactance of 1.5 k $\Omega$  at 100 Hz. The resulting noise due to the amplifier's input noise current can dominate the noise voltage at the output of the playback system. The inputs of the amplifiers are biased from a common reference voltage that is temperature compensated to produce a quiescent DC voltage of 2.5V at the output of the first stage. The input stage bias current that flows through the tape head is kept below 2  $\mu$ A in order to prevent any erasure of tape moving past the head. An added advantage of DC biasing is the prevention of large current transients during the charging of coupling capacitors at turn-on and turn-off. The outputs of the forward and reverse preamplifier are fed to the common output op amp through a logic controlled switch.

The second stage provides additional gain and proper equalization while preventing audible turn-on transients or "pops". The output (pin 2) is kept low until C2 charges through R1. When the voltage on C2 gets close to the DC voltage on pin 5, the output rises exponentially to its final DC value. The result is a transient-free turn-on characteristic.

Internal diodes are provided to facilitate electronic diode switching, popular in automotive applications.

The General Test Circuit illustrates the topography of the system. The components determining the overall frequency response are external due to the extreme sensitivity when matching a DIN equalization curve.

## MUTE CIRCUIT AND LOGIC

The LM1837 can be muted with the addition of two resistors and a grounding switch, as shown in *Figure 1*. When the circuit is not muted the additional resistors have no effect on the AC performance. They *do* have an effect on the DC Q point however.

The difference in the DC output voltages of the input amplifiers is applied across the mute resistors (R7) and the positive input resistors (R1). This results in an additional offset at the input of the output amplifiers. To keep this offset to a minimum R7 should be as large as possible to achieve effective muting. Unmute voltage is the peak signal the preamplifier can swing without turning on the output amplifier under mute conditions:

$$\text{Unmute voltage} = V_{\text{PIN 5, 14}} \left[ \frac{R5//R3}{R2 + R5//R3} - \frac{R7}{R1 + R7} \right]$$

## Application Hints (Continued)

For example: The circuit in *Figure 1* has 2.5V DC at pins 5 and 14, so:

Unmute voltage =

$$2.5V \left[ \frac{1.2M//1.5M}{10k + 1.2M//1.5M} - \frac{270k}{10k + 270K} \right] = 52.3 \text{ mV}$$

It may be necessary to slow the transition of the logic pin if the mute circuit is not used. The forward and reverse pre-amplifier output DC voltages can differ by  $\pm 100$  mV. This rapid DC charge is gained up by the output amplifier and appears as a pop. The circuit of *Figure 8* will slow the DC transition.

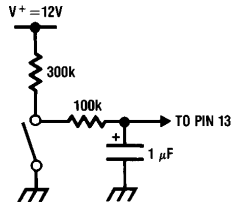

TL/H/7902-17

FIGURE 8. Circuit to Slow Logic

### DESIGN EQUATIONS

The overall gain of the circuit is given by:

$$A_v = 25 \left[ \frac{-R_4 R_3}{R_2(R_3 + R_4)} \right] \left( s + \frac{1}{R_4 C_1} \right) \left( s + \frac{1}{(R_3 + R_4) C_1} \right) \quad (1)$$

Standard cassette tapes require equalization of 3180  $\mu$ s (50 Hz) and 120  $\mu$ s (1.3 kHz). These time constants result in an AC gain at 1 kHz given by:

$$A_v(1 \text{ kHz}) = 25 \left( \frac{-R_4 R_3}{R_2(R_3 + R_4)} \right) 1.663 \quad (2)$$

$$\left\{ \begin{array}{l} 3180 \mu\text{s or } 50 \text{ Hz} \\ \text{and} \\ 120 \mu\text{s or } 1326 \text{ Hz} \end{array} \right\}$$

Using the pole and zero locations of the transfer function, the two other equations needed to solve for the component values are:

$$R_4 = \frac{1}{2\pi C_1(1326 \text{ Hz})} \quad (3)$$

$$R_3 = \frac{1}{2\pi C_1(50 \text{ Hz})} - \frac{1}{2\pi C_1(1326 \text{ Hz})} = \frac{1}{2\pi C_1(51.96)} \quad (4)$$

We can now solve for  $C_1$  as a function of  $R_2$ , or:

$$A_v(1 \text{ kHz}) = -25 \left\{ \frac{\left[ \frac{1}{2\pi C_1(1326)} \right] \left[ \frac{1}{2\pi C_1(51.96)} \right]}{\left[ R_2 \frac{1}{2\pi C_1(50)} \right]} \right\} (1.663) \quad (5)$$

$$C_1 = \frac{-4.80 \times 10^{-3}}{R_2 [A_v(1 \text{ kHz})]} \quad (6)$$

When chromium dioxide is used, the defined time constants are 3180  $\mu$ s and 70  $\mu$ s. This changes equation (3) to:

$$R_4 = \frac{1}{2\pi C_1(2274 \text{ Hz})} \quad (7)$$

The value of  $R_3$  is normally not changed. This results in an error of less than 0.2 dB in the low frequency response.

The output voltage of the LM1837 is set by the input amplifier DC voltage at pin 5 or 14, and by  $R_3$  and  $R_5$ .

$$\text{Nominal } V_{OUT}(\text{pin 2 or 17}) = 2.5 \left( 1 + \frac{R_3}{R_5} \right) \quad (8)$$

Pins 1 and 18 are biased 0.7V less than  $V_{OUT}(\text{pin 2 or 17})$ . When these diodes are used the output (pin 2 or 17) should be biased at one half the minimum operating supply voltage. Equation (8) can be rewritten to solve for  $R_5$ .

$$R_5 = \frac{2.5 R_3}{V_O - 2.5} \quad (9)$$

The output voltage of the LM1837 will vary from that given in equation (8) due to variations in the input amplifier DC voltage as well as the output amplifier input bias current, input offset current and input offset voltage. The following equation gives the worst-case variation in the output voltage in either forward or reverse state.

$$\Delta V_{OUT} = \pm \left[ \Delta V_{PIN3} \left( 1 + \frac{R_3}{R_5} \right) + \frac{R_3}{R_2} \left( \Delta I_{BIAS} (R_1 - R_2) + \frac{I_{OS}}{2} (R_1 + R_2) + V_{OS} \right) \right] \quad (10)$$

Using the worst-case values in the electrical characteristics reduces this to

$$\Delta V_{OUT} = \pm \left[ 0.4 \left( 1 + \frac{R_3}{R_5} \right) + \frac{R_3}{R_2} \left( 200 \text{ nA} (R_1 - R_2) + 50 \text{ nA} (R_1 + R_2) + 5 \text{ mV} \right) \right] \quad (11)$$

Equation (10) does not incorporate the effect of mute resistors on the output voltage. The presence of mute resistors causes an additional offset

$$\Delta V_{OUT}(\text{mute}) = \pm \frac{\Delta V(\text{pins 5-14})}{2(R_1 + R_7)} \times R_1 \quad (12)$$

For the circuit in *Figure 1* worst-case:

$$\Delta V_{OUT}(\text{mute}) = \frac{400 \text{ mV}}{2(20k + 270k)} \times 1.5M = 1V$$

This means that the output pins 2 and 17 would differ by 1V. The trade off here is the amount of unmute voltage versus the DC accuracy of pins 2 and 17.

## Application Hints (Continued)

The turn-on delay is set by R1 and C2; delay can be approximated by:

$$\text{Delay time } t = R1C2 \ln \left( \frac{2.5}{V_{ODC}} \right) \left( \frac{R3}{R2} \right) \quad (13)$$

### EXAMPLE

If we desire a tape preamp with 100 mV output signal from a tape head with a nominal output of 0.5 mV at 1 kHz for standard ferric cassette tape, the external components are determined as follows. The value of R2 is arbitrarily set to 10 k $\Omega$ .

$$R1 = R2 = 10k$$

This minimizes errors due to the output amplifier bias currents.

$$C1 = \frac{-4.80 \times 10^{-3}}{10 \text{ k}\Omega \left[ \frac{-100 \text{ mV}}{0.5 \text{ mV}} \right]} = 2400 \text{ pF} \rightarrow 0.0022 \text{ }\mu\text{F}$$

Use 0.0022  $\mu\text{F}$  and determine:

$$R4 = \frac{1}{2\pi C1(1326)} = 54.6 \text{ k}\Omega \rightarrow 54.9 \text{ k}\Omega \text{ 1\%}$$

$$R3 = \frac{1}{2\pi C1(51.96)} = 1.39 \text{ M}\Omega \rightarrow 1.4 \text{ M}\Omega \text{ 1\%}$$

To bias the output amplifier output voltage at 6V (half supply):

$$R5 = \frac{2.5(1.4 \text{ M}\Omega)}{6 - 2.5} = 1 \text{ M}\Omega$$

The maximum variation in the output is found using equation (11):

$$\Delta V_{OUT} = \pm 1.9V$$

The low frequency response and turn-on delay determine the value of C2. For R1 = 10k and C2 = 10  $\mu\text{F}$  the low frequency 3 dB point is 1.6 Hz and the turn-on delay is 0.4 seconds, from equation (12).

The complete circuit is shown in *Figure 2*. A circuit with 5% components and biased for a minimum supply of 10V is shown in *Figure 1*. If additional gain is needed R1 and R2 can be reduced without changing the frequency response of the circuit.

### DIODE SWITCHING

The LM1837 has a diode in series with each output for source switching applications. The outputs of several functional blocks can be diode OR-connected as shown in *Figure 9*.

By removing the power supply from the FM demodulator, its output diode will be cut off by the LM1837 output DC voltage. R6 is used to bias ON the diode of the LM1837 when power is applied to it. When the output is taken from pin 1 or pin 18, the THD will be higher because of the current modulation in the diode.

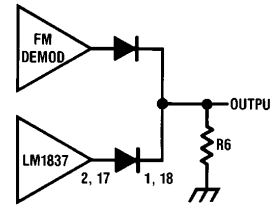

TL/H/7902-18

FIGURE 9

### CROSSTALK AND CHANNEL SEPARATION

When two signal sources share a common reference point which is separated from ground by a resistance, there will always be some amount of interchannel crosstalk (the reciprocal of channel separation) induced. The coupling method of *Figure 1* is examined to determine whether the induced crosstalk is acceptably low.

*Figure 10* is the equivalent AC circuit for the connection scheme of *Figure 1*.  $R_B$  is the Thevenin resistance of the common bias point,  $R_{IN}$  is the preamplifier input resistance,  $Z_S$  is the impedance of the playback head, and  $V_{S7}$ ,  $V_{S8}$ ,  $V_{S11}$ , and  $V_{S12}$  are the open-circuit output voltages of the sources. If we set  $V_{S8}$ ,  $V_{S11}$ , and  $V_{S12}$  equal to zero, we can define crosstalk for this circuit as  $V_{12}/V_7$ , where  $V_7$  and  $V_{12}$  are the AC signal voltages appearing at the two preamplifier inputs, assuming  $R_B \ll R_{IN}/3$ .

The crosstalk can be shown to be:

$$\frac{V_{12}}{V_7} = \frac{R_B}{R_B + Z_S + R_{IN}/3}$$

Since  $Z_S$  is dependent on the measurement frequency and the particular head used, we choose the worst-case condition and set  $Z_S = 0$ . The minimum value of  $R_{IN}$  is 150 k $\Omega$ , and  $R_B \approx 100\Omega$ . This yields a crosstalk figure of:

$$\frac{V_{12}}{V_7} = \frac{100}{50100} = -54 \text{ dB}$$

This is 14 dB better than the minimum guaranteed channel separation, so the connection method of *Figure 1* will provide acceptable crosstalk levels.

**Reference 1:** CCIR/ARM: *A Practical Noise Measurement Method*; by Ray Dolby, David Robinson and Kenneth Gundry, AES Preprint No. 1353 (F-3).

**Application Hints** (Continued)

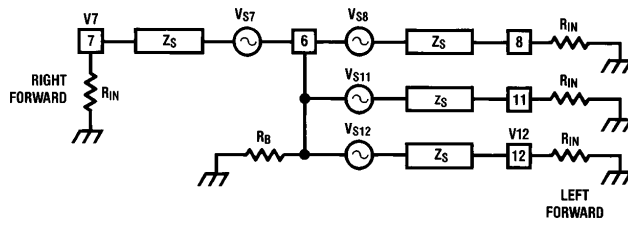

TL/H/7902-19

**FIGURE 10.** AC Equivalent of *Figure 1*

**Physical Dimensions** inches (millimeters)

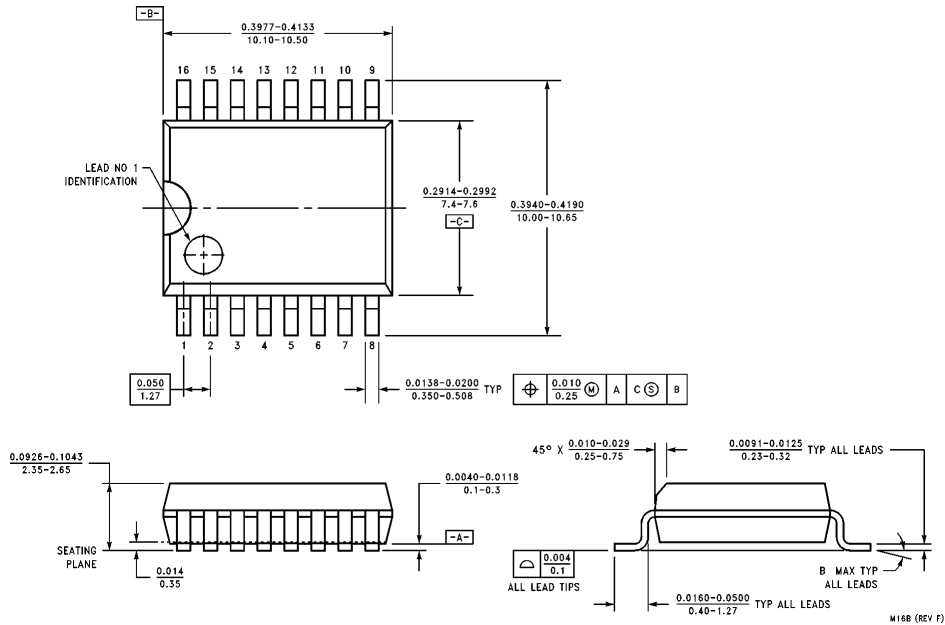

**Narrow Small Outline Package (M)**  
**Order Number LM1837M**  
**NS Package Number M16B**

**Physical Dimensions** inches (millimeters) (Continued)

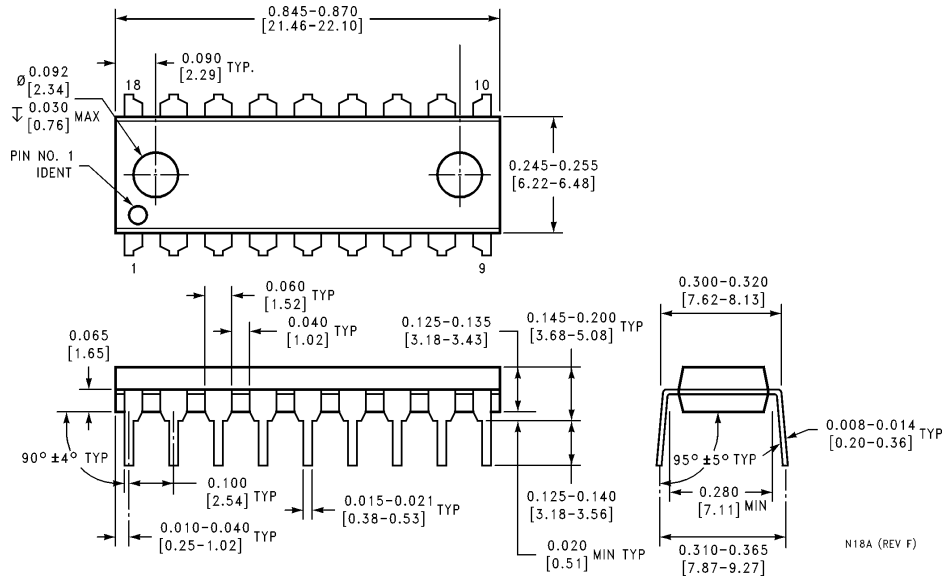

**Molded Dual-In-Line Package (N)**  
**Order Number LM1837N**  
**NS Package Number N18A**

N18A (REV F)



**National Semiconductor Corporation**  
 1111 West Bardin Road  
 Arlington, TX 76017  
 Tel: 1(800) 272-9959  
 Fax: 1(800) 737-7018

**National Semiconductor Europe**  
 Fax: (+49) 0-180-530 85 86  
 Email: cnjwge@tevm2.nsc.com  
 Deutsch Tel: (+49) 0-180-530 85 85  
 English Tel: (+49) 0-180-532 78 32  
 Français Tel: (+49) 0-180-532 93 58  
 Italiano Tel: (+49) 0-180-534 16 80

**National Semiconductor Hong Kong Ltd.**  
 19th Floor, Straight Block,  
 Ocean Centre, 5 Canton Rd.  
 Tsimshatsui, Kowloon  
 Hong Kong  
 Tel: (852) 2737-1600  
 Fax: (852) 2736-9960

**National Semiconductor Japan Ltd.**  
 Tel: 81-043-299-2309  
 Fax: 81-043-299-2408

National does not assume any responsibility for use of any circuitry described, no circuit patent licenses are implied and National reserves the right at any time without notice to change said circuitry and specifications.

This datasheet has been download from:

[www.datasheetcatalog.com](http://www.datasheetcatalog.com)

Datasheets for electronics components.

# National Semiconductor was acquired by Texas Instruments.

[http://www.ti.com/corp/docs/investor\\_relations/pr\\_09\\_23\\_2011\\_national\\_semiconductor.html](http://www.ti.com/corp/docs/investor_relations/pr_09_23_2011_national_semiconductor.html)

This file is the datasheet for the following electronic components:

LM1837 - <http://www.ti.com/product/lm1837?HQS=TI-null-null-dscatalog-df-pf-null-ww>