	<b>METALLIZED POLYPROPYLENE FILM</b> <b>AC AND PULSE CAPACITOR</b> <b>MKP 378 MKP/MKP378</b> <b>MKP AND MKP/MKP RADIAL POTTED TYPE</b>	Doc. No: HQN-384-17/102
		Rev. : W
		Iss. Date: 2006-10-16
		Page 1 of 19

VISHAY BCcomponents

**MKP 378 MKP/MKP 378**  
**AC and Pulse metallized**  
**polypropylene film capacitor**

File under TPD sheet 190, HQN-384-17/102

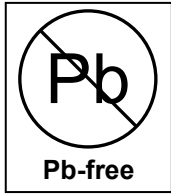

## AC and Pulse Metallized Polypropylene Film Capacitors MKP and MKP/MKP Radial Potted Type

**APPLICATIONS**

Where steep pulses occur e.g. SMPS (switch mode power supplies). Motor control circuits. S-correction. It is not advised to use these products as resonance capacitors in fly-back applications

**MARKING**

C-value; tolerance; rated voltage; manufacturer's type designation; code for dielectric material; manufacturer's emblem; code for factory of origin; year and week of manufacture

**DIELECTRIC**

Polypropylene film

**ELECTRODES**

Metallized film

**ENCAPSULATION**

Flame retardant plastic case and epoxy resin (UL-class 94 V-0)

**CONSTRUCTION**

Internal serial construction

**LEADS**

Tinned wire 

**CAPACITANCE RANGE (E24 SERIES)**

MKP: 0.18 to 3.3  $\mu$ F  
MKP/MKP: 0.003 to 0.68  $\mu$ F

**CAPACITANCE TOLERANCE**

$\pm 5\%$

**RATED (DC)VOLTAGE**

MKP: 250V; 400V  
MKP/MKP: 630V; 1000V; 1600V; 2000V

**RATED (AC) VOLTAGE**

MKP: 160V; 200V  
MKP/MKP: 300V; 400V; 500V; 600V

**RATED PEAK-TO-PEAK VOLTAGE**

MKP: 450V; 560V  
MKP/MKP: 850V; 1130V; 1400V; 1700V

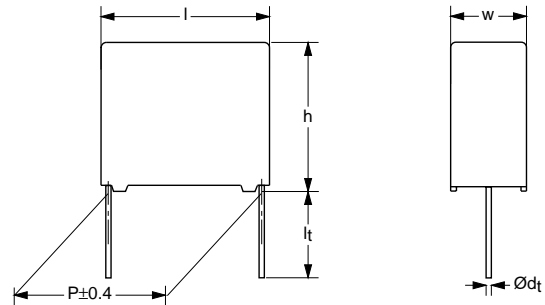

CBB817

**CLIMATIC CATEGORY**

55/085/56

**RATED (DC) TEMPERATURE**

85 °C

**RATED (AC) TEMPERATURE**

70 °C

**MAXIMUM APPLICATION TEMPERATURE**

85 °C

**REFERENCE SPECIFICATIONS**

IEC 60384-17

**PERFORMANCE GRADE**

Grade 1 (long life)

**STABILITY GRADE**

Pitch 15 mm: grade 2  
Pitch 22.5 and 27.5 mm: grade 1

**FEATURES**

15.0 to 27.5 mm pitch.  
Supplied loose in box, taped on reel  
RoHS compliant

**DETAIL INSPECTION AND TEST REQUIREMENTS**

See Technical Product Documentation sheet 191.

**COMPOSITION OF CATALOGUE NUMBER**

TYPE AND PITCHES	
378	15.0 mm
	22.5 mm
	27.5 mm

**CAPACITANCE**  
(numerically)

MULTIPLIER (nF)	
0.1	2
1	3
10	4

Example:  
104 = 10 x 10 = 100 nF

<b>2222</b>	<b>378</b>	<b>XX</b>	<b>XX</b>	<b>X</b>
<b>BFC2(*)</b>	<b>378</b>	<b>XX</b>	<b>XX</b>	<b>X</b>

(\*) Use this part number for those with access to the Vishay SAP system and Partners websites within the Americas

TYPE	PACKAGING	LEAD CONFIGURATION	PREFERRED TYPES						
			C-TOL	250V	400V	630V	1000V	1600V	2000V
378 MKP/MKP	loose in box	lead length 3.5 ± 0.3 mm	±5%	-	-	64	74	84	94
			<b>ON REQUEST</b>						
378 MKP	loose in box	lead length 3.5 ± 0.3 mm	±5%	44	54	-	-	-	-
	loose in box	lead length 5.0 ± 1.0 mm		42	52	-	-	-	-
	Taped on reel	H = 18.5 mm; P <sub>0</sub> = 12.7 mm		45	55	-	-	-	-
378 MKP/MKP	loose in box	lead length 5.0 ± 1.0 mm	±5%	-	-	62	72	82	92
	Taped on reel	H = 18.5 mm; P <sub>0</sub> = 12.7 mm		-	-	65	75	85	95

<b>AVAILABLE VERSIONS 378 MKP/MKP ON SPECIAL REQUEST</b>				
Pitch = 15.0 ± 0.4 mm; w x h x l = 8.5mm x 15.0mm x 17.5 mm				
Voltage (V DC)	C (µF)	Loose in box; SPQ=1000		Taped on reel; SPQ=650
		lead length 3.5 ± 0.3 mm	lead length 5.0 ± 1.0 mm	H = 18.5 mm; P <sub>0</sub> = 12.7 mm
630	0.056	2222 378 90042	2222 378 90043	2222 378 90044
	0.068	2222 378 90046	2222 378 90047	2222 378 90048
1000	0.012	2222 378 90051	2222 378 90052	2222 378 90053
	0.013	2222 378 90055	2222 378 90056	2222 378 90057
	0.015	2222 378 90059	2222 378 90061	2222 378 90062
	0.016	2222 378 90064	2222 378 90065	2222 378 90066
	0.018	2222 378 90068	2222 378 90069	2222 378 90071

	<b>METALLIZED POLYPROPYLENE FILM AC AND PULSE CAPACITOR MKP 378 MKP/MKP378 MKP AND MKP/MKP RADIAL POTTED TYPE</b>	Doc. No: HQN-384-17/102
		Rev. : W
		Iss. Date: 2006-10-16
		Page 4 of 19

**Specific reference data MKP (250VDC)**

DESCRIPTION	VALUE	
	at 10 kHz	at 100 kHz
Tangent of loss angle:		
$C \leq 0.43 \mu\text{F}$	$\leq 15 \times 10^{-4}$	$\leq 45 \times 10^{-4}$
$0.47 \mu\text{F} \leq C \leq 0.62 \mu\text{F}$	$\leq 15 \times 10^{-4}$	$\leq 55 \times 10^{-4}$
$0.68 \mu\text{F} \leq C \leq 0.82 \mu\text{F}$	$\leq 15 \times 10^{-4}$	$\leq 60 \times 10^{-4}$
$0.91 \mu\text{F} \leq C \leq 1.0 \mu\text{F}$	$\leq 20 \times 10^{-4}$	$\leq 90 \times 10^{-4}$
$1.1 \mu\text{F} \leq C \leq 3.3 \mu\text{F}$	$\leq 20 \times 10^{-4}$	$\leq 200 \times 10^{-4}$
Rated voltage pulse slope (dU/dt) <sub>R</sub> :	90 V/μs	
Pitch = 22.5 mm	60 V/μs (w < 15mm)	
Pitch = 27.5 mm	30 V/μs (w ≥ 15mm)	
R between leads, for C ≤ 1 μF at 100 V; 1 minute	> 100 000 MΩ	
RC between leads, for C > 1 μF at 100 V; 1 minute	> 100 000 s	
Ionization (AC) voltage (typical value) at 50 pC peak discharge	> 220 V	
Withstanding (DC)voltage (cut off current 10 mA); rise time 100 V/s:	400 V; 1 minute	
Withstanding (DC) voltage between leads and case	500 V; 1 minute	

**U<sub>Rdc</sub> = 250 V; U<sub>Rac</sub> = 160 V; U<sub>p-p</sub>=450V**

C (μF)	DIMENSIONS w x h x l (mm)	MASS (g)	CATALOGUE NUMBER 2222 378 ...AND PACKAGING		
			LOOSE IN BOX		REEL
			L <sub>t</sub> = 5.0±1.0 mm	all leads	
			Last 5 digits	SPQ	SPQ
<b>Pitch = 22.5 ± 0.4 mm; d<sub>t</sub> = 0.80 ± 0.08 mm</b>					
0.33	7.0x16.5x26.0	2.9	42334	200	550
0.36			42364		
0.39			42394		
0.43	8.5x18.0x26.0	3.8	42434	200	450
0.47			42474		
0.51			42514		
0.56			42564		
0.62			42624		
0.68	10.0x19.5x26.0	6.8	42684	200	350
0.75			42754		
0.82			42824		
<b>Pitch = 27.5 ± 0.4 mm; d<sub>t</sub> = 0.80 ± 0.08 mm</b>					
0.91	11.0x21.0x31.0	7.4	42914	100	
1.0			42105		
1.1			42115		
1.2			42125		
1.3			42135		
1.5	13.0x23.0x31.0	9.2	42155	100	
1.6			42165		
1.8			42185		
2.0	15.0x25.0x31.0	12.3	42205	100	
2.2			42225		
2.4	18.0x28.0x31.0	16.1	42245	100	
2.7			42275		
3.0			42305		
3.3			42335		

**Specific reference data MKP (400VDC)**

DESCRIPTION	VALUE	
	at 10 kHz	at 100 kHz
Tangent of loss angle:		
$C \leq 0.24 \mu\text{F}$	$\leq 10 \times 10^{-4}$	$\leq 30 \times 10^{-4}$
$0.27 \mu\text{F} \leq C \leq 0.36 \mu\text{F}$	$\leq 10 \times 10^{-4}$	$\leq 35 \times 10^{-4}$
$0.39 \mu\text{F} \leq C \leq 0.51 \mu\text{F}$	$\leq 10 \times 10^{-4}$	$\leq 40 \times 10^{-4}$
$0.56 \mu\text{F} \leq C \leq 0.68 \mu\text{F}$	$\leq 15 \times 10^{-4}$	$\leq 50 \times 10^{-4}$
$0.75 \mu\text{F} \leq C \leq 1.0 \mu\text{F}$	$\leq 15 \times 10^{-4}$	$\leq 70 \times 10^{-4}$
$1.1 \mu\text{F} \leq C \leq 2.0 \mu\text{F}$	$\leq 15 \times 10^{-4}$	$\leq 150 \times 10^{-4}$
Rated voltage pulse slope $(dU/dt)_R$ :	100 V/ $\mu\text{s}$	
Pitch = 22.5 mm	70 V/ $\mu\text{s}$ (w < 15mm)	
Pitch = 27.5 mm	35 V/ $\mu\text{s}$ (w $\geq$ 15mm)	
R between leads, for $C \leq 1 \mu\text{F}$ at 100V; 1 minute	> 100 000 M $\Omega$	
RC between leads, for $C > 1 \mu\text{F}$ at 100V; 1 minute	> 100 000 s	
Ionization (AC) voltage (typical value) at 50 pC peak discharge	> 250 V	
Withstanding (DC)voltage (cut off current 10 mA); rise time 100 V/s:	640 V; 1 minute	
Withstanding (DC) voltage between leads and case	800 V; 1 minute	

 **$U_{Rdc} = 400 \text{ V}$ ;  $U_{Rac} = 200 \text{ V}$ ;  $U_{p-p} = 560 \text{ V}$** 

C ( $\mu\text{F}$ )	DIMENSIONS w x h x l (mm)	MASS (g)	CATALOGUE NUMBER 2222 378 ...AND PACKAGING		
			LOOSE IN BOX		REEL
			$L_t = 5.0 \pm 1.0 \text{ mm}$	all leads	
			Last 5 digits	SPQ	SPQ
<b>Pitch = 22.5 <math>\pm</math> 0.4 mm; <math>d_t = 0.80 \pm 0.08 \text{ mm}</math></b>					
0.18	7.0x16.5x26.0	2.9	52184	200	550
0.20			52204		
0.22			52224		
0.24	8.5x18.0x26.0	3.8	52244	200	450
0.27			52274		
0.30			52304		
0.33			52334		
0.36			52364		
0.39	10.0x19.5x26.0	6.8	52394	200	350
0.43			52434		
0.47			52474		
			52474		
<b>Pitch = 27.5 <math>\pm</math> 0.4 mm; <math>d_t = 0.80 \pm 0.08 \text{ mm}</math></b>					
0.51	11.0x21.0x31.0	7.4	52514	100	
0.56			52564		
0.62			52624		
0.68			52684		
0.75	13.0x23.0x31.0	9.2	52754	100	
0.82			52824		
0.91			52914		
1.0			52105		
1.1			52115		
1.2	15.0x25.0x31.0	12.3	52125	100	
1.3			52135		
1.5			52155		
1.6	18.0x28.0x31.0	16.1	52165	100	
1.8			52185		
2.0			52205		
			52205		

	<b>METALLIZED POLYPROPYLENE FILM AC AND PULSE CAPACITOR MKP 378 MKP/MKP378 MKP AND MKP/MKP RADIAL POTTED TYPE</b>	Doc. No: HQN-384-17/102
		Rev. : W
		Iss. Date: 2006-10-16
		Page 6 of 19

**Specific reference data MKP/MKP (630VDC)**

DESCRIPTION	VALUE	
	at 10 kHz	at 100 kHz
Tangent of loss angle:		
$C \leq 0.18 \mu\text{F}$	$\leq 8 \times 10^{-4}$	$\leq 15 \times 10^{-4}$
$0.20 \mu\text{F} \leq C \leq 0.30 \mu\text{F}$	$\leq 10 \times 10^{-4}$	$\leq 25 \times 10^{-4}$
$0.33 \mu\text{F} \leq C \leq 0.39 \mu\text{F}$	$\leq 10 \times 10^{-4}$	$\leq 30 \times 10^{-4}$
$0.43 \mu\text{F} \leq C \leq 0.51 \mu\text{F}$	$\leq 10 \times 10^{-4}$	$\leq 40 \times 10^{-4}$
$C > 0.51 \mu\text{F}$	$\leq 10 \times 10^{-4}$	$\leq 45 \times 10^{-4}$
Rated voltage pulse slope (dU/dt) <sub>R</sub> :		
Pitch = 15 mm	500 V/μs	
Pitch = 22.5 mm	370 V/μs	
Pitch = 27.5 mm	230 V/μs (w < 15mm)	
Pitch = 27.5 mm	120 V/μs (w ≥ 15mm)	
R between leads, for C ≤ 1 μF at 500 V; 1 minute	> 100 000 MΩ	
R between leads and case; 500 V; 1 minute	> 100 000 MΩ	
Ionization (AC) voltage (typical value) at 50 pC peak discharge	> 400 V	
Withstanding (DC)voltage (cut off current 10 mA); rise time 100 V/s:	1008 V; 1 minute	
Withstanding (DC) voltage between leads and case	2840 V; 1 minute	

**U<sub>Rdc</sub> = 630 V; U<sub>Rac</sub> = 300 V; U<sub>p-p</sub> = 850V**

C (μF)	DIMENSIONS w x h x l (mm)	MASS (g)	CATALOGUE NUMBER 2222 378 ...AND PACKAGING		
			LOOSE IN BOX		REEL
			L <sub>t</sub> = 3.5±0.3 mm	all leads	
			Last 5 digits	SPQ	SPQ
<b>Pitch = 15.0 ± 0.4 mm; d<sub>t</sub> = 0.60 ± 0.06 mm</b>					
0.015	5.0x11.0x17.5	1.0	64153	1000	1100
0.016			64163		
0.018			64183		
0.020			64203		
0.022			64223		
0.024	6.0x12.0x17.5	1.4	64243	1000	900
0.027			64273		
0.030			64303		
0.033			64333		
<b>Pitch = 15.0 ± 0.4 mm; d<sub>t</sub> = 0.80 ± 0.08 mm</b>					
0.036	7.0x13.5x17.5	1.8	64363	1000	800
0.039			64393		
0.043			64433		
0.047	8.5x15.0x17.5	2.4	64473	1000	650
0.051			64513		
<b>Pitch = 22.5 ± 0.4 mm; d<sub>t</sub> = 0.80 ± 0.08 mm</b>					
0.056	6.0x15.5x26.0	2.4	64563	300	600
0.062			64623		
0.068	7.0x16.5x26.0	2.9	64683	200	550
0.075			64753		
0.082			64823		
0.091			64913		
0.10			64104		
0.11	8.5x18.0x26.0	3.8	64114	200	450
0.12			64124		
0.13			64134		
0.15	10.0x19.5x26.0	6.8	64154	200	350
0.16			64164		
0.18			64184		

C ( $\mu$ F)	DIMENSIONS w x h x l (mm)	MASS (g)	CATALOGUE NUMBER 2222 378 ...AND PACKAGING		
			LOOSE IN BOX		REEL
			$L_t = 3.5 \pm 0.3$ mm	all leads	
			Last 5 digits	SPQ	SPQ
<b>Pitch = <math>27.5 \pm 0.4</math> mm; <math>d_t = 0.80 \pm 0.08</math> mm</b>					
0.20	11.0x21.0x31.0	7.4	64204	100	
0.22			64224		
0.24			64244		
0.27			64274		
0.30	13.0x23.0x31.0	9.2	64304	100	
0.33			64334		
0.36			64364		
0.39			64394		
0.43	15.0x25.0x31.0	12.3	64434	100	
0.47			64474		
0.51			64514		
0.56	18.0x28.0x31.0	16.1	64564	100	
0.62			64624		
0.68			64684		

**Specific reference data MKP/MKP (1000VDC)**

DESCRIPTION	VALUE	
	at 10 kHz	at 100 kHz
Tangent of loss angle:		
$C \leq 0.051 \mu\text{F}$	$\leq 6 \times 10^{-4}$	$\leq 15 \times 10^{-4}$
$0.056 \mu\text{F} \leq C \leq 0.22 \mu\text{F}$	$\leq 8 \times 10^{-4}$	$\leq 20 \times 10^{-4}$
Rated voltage pulse slope $(dU/dt)_R$ :		
Pitch = 15 mm	1300 V/ $\mu$ s	
Pitch = 22.5 mm	1200 V/ $\mu$ s	
Pitch = 27.5 mm	600 V/ $\mu$ s (w < 15mm)	
Pitch = 27.5 mm	300 V/ $\mu$ s (w $\geq$ 15mm)	
R between leads, for $C \leq 1 \mu\text{F}$ at 500 V; 1 minute	> 100 000 M $\Omega$	
R between leads and case; 500 V; 1 minute	> 100 000 M $\Omega$	
Ionization (AC) voltage (typical value) at 50 pC peak discharge	> 500 V	
Withstanding (DC)voltage (cut off current 10 mA); rise time 100 V/s:	1600 V; 1 minute	
Withstanding (DC) voltage between leads and case	2840 V; 1 minute	

 **$U_{Rdc} = 1000$  V;  $U_{Rac} = 400$  V;  $U_{p-p} = 1130$  V**

C ( $\mu$ F)	DIMENSIONS w x h x l (mm)	MASS (g)	CATALOGUE NUMBER 2222 378 ...AND PACKAGING		
			LOOSE IN BOX		REEL
			$L_t = 3.5 \pm 0.3$ mm	all leads	
			Last 5 digits	SPQ	SPQ
<b>Pitch = <math>15.0 \pm 0.4</math> mm; <math>d_t = 0.60 \pm 0.06</math> mm</b>					
0.0030	5.0x11.0x17.5	1.0	74302	1000	1100
0.0033			74332		
0.0036			74362		
0.0039			74392		
0.0043			74432		
0.0047			74472		
0.0051			74512		
0.0056			74562		
0.0062			74622		
0.0068			74682		
0.0075			74752		

C ( $\mu$ F)	DIMENSIONS w x h x l (mm)	MASS (g)	CATALOGUE NUMBER 2222 378 ...AND PACKAGING		
			LOOSE IN BOX		REEL
			$L_t = 3.5 \pm 0.3$ mm	all leads	
			Last 5 digits	SPQ	SPQ
0.0082 0.0091 0.010 0.011	6.0x12.0x17.5	1.4	74822 74912 74103 74113	1000	900
<b>Pitch = <math>22.5 \pm 0.4</math> mm; <math>d_t = 0.80 \pm 0.08</math> mm</b>					
0.012 0.013 0.015 0.016 0.018	6.0x15.5x26.0	2.4	74123 74133 74153 74163 74183	300	600
0.020 0.022 0.024	7.0x16.5x26.0	2.9	74203 74223 74243	200	550
0.027 0.030 0.033 0.036	8.5x18.0x26.0	3.8	74273 74303 74333 74363	200	450
0.039 0.043 0.047 0.051	10.0x19.5x26.0	6.8	74393 74433 74473 74513	200	350
<b>Pitch = <math>27.5 \pm 0.4</math> mm; <math>d_t = 0.80 \pm 0.08</math> mm</b>					
0.056 0.062 0.068 0.075 0.082	11.0x21.0x31.0	7.4	74563 74623 74683 74753 74823	100	
0.091 0.10 0.11	13.0x23.0x31.0	9.2	74913 74104 74114	100	
0.12 0.13 0.15	15.0x25.0x31.0	12.3	74124 74134 74154	100	
0.16 0.18 0.20 0.22	18.0x28.0x31.0	16.1	74164 74184 74204 74224	100	



	<b>METALLIZED POLYPROPYLENE FILM</b> <b>AC AND PULSE CAPACITOR</b> <b>MKP 378 MKP/MKP378</b> <b>MKP AND MKP/MKP RADIAL POTTED TYPE</b>	Doc. No: HQN-384-17/102
		Rev. : W
		Iss. Date: 2006-10-16
		Page 9 of 19

**Specific reference data MKP/MKP (1600VDC)**

DESCRIPTION	VALUE	
	at 10 kHz	at 100 kHz
Tangent of loss angle: C ≤ 0.022μF 0.024 μF ≤ C ≤ 0.1 μF	≤5 x 10 <sup>-4</sup> ≤6 x 10 <sup>-4</sup>	≤10 x 10 <sup>-4</sup> ≤15 x 10 <sup>-4</sup>
Rated voltage pulse slope (dU/dt) <sub>R</sub> : Pitch = 22.5 mm Pitch = 27.5 mm Pitch = 27.5 mm	1600 V/μs 900 V/μs (w < 15mm) 450 V/μs (w ≥ 15mm)	
R between leads, for C ≤ 1 μF at 500 V; 1 minute	> 100 000 MΩ	
R between leads and case; 500 V; 1 minute	> 100 000 MΩ	
Ionization (AC) voltage (typical value) at 20 pC peak discharge	> 600 V	
Withstanding (DC)voltage (cut off current 10 mA); rise time 100 V/s:	2560 V; 1 minute	
Withstanding (DC) voltage between leads and case	2840 V; 1 minute	

**U<sub>Rdc</sub> = 1600 V; U<sub>Rac</sub> = 500 V; U<sub>p-p</sub>=1400V**

C (μF)	DIMENSIONS w x h x l (mm)	MASS (g)	CATALOGUE NUMBER 2222 378 ...AND PACKAGING		
			LOOSE IN BOX		REEL
			L <sub>t</sub> = 3.5±0.3 mm	all leads	
			Last 5 digits	SPQ	SPQ
<b>Pitch = 22.5 ± 0.4 mm; d<sub>t</sub> = 0.80 ± 0.08 mm</b>					
0.0056	6.0x15.5x26.0	2.4	84562	300	600
0.0062			84622		
0.0068			84682		
0.0075	7.0x16.5x26.0	2.9	84752	200	550
0.0082			84822		
0.0091			84912		
0.010			84103		
0.011	8.5x18.0x26.0	3.8	84113	200	450
0.012			84123		
0.013			84133		
0.015			84153		
0.016			84163		
0.018	10.0x19.5x26.0	6.8	84183	200	350
0.020			84203		
0.022			84223		
<b>Pitch = 27.5 ± 0.4 mm; d<sub>t</sub> = 0.80 ± 0.08 mm</b>					
0.024	11.0x21.0x31.0	7.4	84243	100	
0.027			84273		
0.030			84303		
0.033			84333		
0.036			84363		
0.039	13.0x23.0x31.0	9.2	84393	100	
0.043			84433		
0.047			84473		
0.051			84513		
0.056	15.0x25.0x31.0	12.3	84563	100	
0.062			84623		
0.068			84683		
0.075	18.0x28.0x31.0	16.1	84753	100	
0.082			84823		
0.091			84913		
0.10			84104		



**METALLIZED POLYPROPYLENE FILM  
AC AND PULSE CAPACITOR  
MKP 378 MKP/MKP378  
MKP AND MKP/MKP RADIAL POTTED TYPE**

Doc. No: HQN-384-17/102  
Rev. : W  
Iss. Date: 2006-10-16  
Page 10 of 19

**Specific reference data MKP/MKP (2000VDC)**

DESCRIPTION	VALUE	
Tangent of loss angle: $C \leq 0.051 \mu\text{F}$	at 10 kHz $\leq 5 \times 10^{-4}$	at 100 kHz $\leq 10 \times 10^{-4}$
Rated voltage pulse slope (dU/dt) <sub>R</sub> : Pitch = 22.5 mm Pitch = 27.5 mm Pitch = 27.5 mm	2000 V/μs 1200 V/μs (w < 15mm) 600 V/μs (w ≥ 15mm)	
R between leads, for C ≤ 1 μF at 500 V; 1 minute	> 100 000 MΩ	
R between leads and case; 500 V; 1 minute	> 100 000 MΩ	
Ionization (AC) voltage (typical value) at 20 pC peak discharge	> 600 V	
Withstanding (DC)voltage (cut off current 10 mA); rise time 100 V/s:	3200 V; 1 minute	
Withstanding (DC) voltage between leads and case	2840 V; 1 minute	

**U<sub>Rdc</sub> = 2000 V; U<sub>Rac</sub> = 600 V; U<sub>p-p</sub>=1700V**

C (μF)	DIMENSIONS w x h x l (mm)	MASS (g)	CATALOGUE NUMBER 2222 378 ...AND PACKAGING		
			LOOSE IN BOX		REEL
			L <sub>t</sub> = 3.5±0.3 mm Last 5 digits	all leads SPQ	SPQ
<b>Pitch = 22.5 ± 0.4 mm; d<sub>t</sub> = 0.80 ± 0.08 mm</b>					
0.0033 0.0036	6.0x15.5x26.0	2.4	94332 94362	300	600
0.0039 0.0043 0.0047 0.0051	7.0x16.5x26.0	2.9	94392 94432 94472 94512	200	550
0.0056 0.0062 0.0068 0.0075 0.0082	8.5x18.0x26.0	3.8	94562 94622 94682 94752 94822	200	450
0.0091 0.010 0.011 0.012	10.0x19.5x26.0	6.8	94912 94103 94113 94123	200	350
<b>Pitch = 27.5 ± 0.4 mm; d<sub>t</sub> = 0.80 ± 0.08 mm</b>					
0.013 0.015 0.016 0.018 0.020	11.0x21.0x31.0	7.4	94133 94153 94163 94183 94203	100	
0.022 0.024 0.027	13.0x23.0x31.0	9.2	94223 94243 94273	100	
0.030 0.033 0.036	15.0x25.0x31.0	12.3	94303 94333 94363	100	
0.039 0.043 0.047 0.051	18.0x28.0x31.0	16.1	94393 94433 94473 94513	100	

**CONSTRUCTION**

**Description**

- Low-inductive wound cell of metallized polypropylene (PP) film, potted with epoxy resin in a flame-retardant polypropylene case
- Radial leads, solder-coated:
- Small stand-off pips allow removal of solder flux etc. during cleaning of the printed-circuit board.

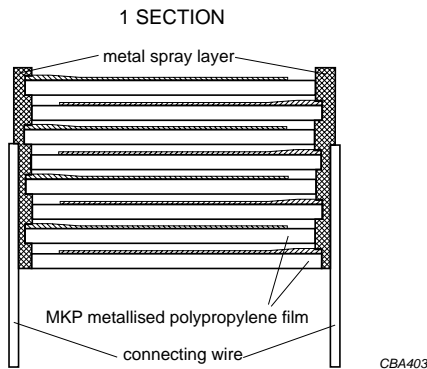

CBA403  
Construction: MKP 250-400V versions; 160-200 V (AC)

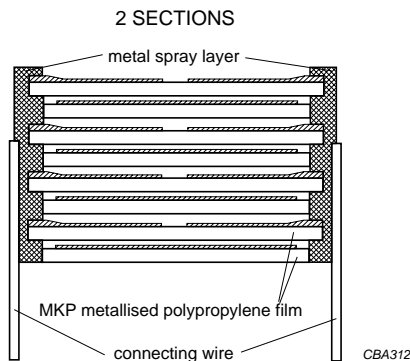

CBA312  
Construction: MKP/MKP 630-2000V versions; 300-600 V (AC)

**Mounting**

**NORMAL USE**

The capacitors are designed for mounting on printed-circuit boards. The capacitors packed in bandoliers are designed for mounting in printed-circuit boards by means of automatic insertion machines. For detailed tape specifications refer to Type detail specification "HQN-384-01/102, Packaging information".

**SPECIFIC METHOD OF MOUNTING TO WITHSTAND VIBRATION AND SHOCK**

In order to withstand vibration and shock tests, it must be ensured that the stand-off pips are in good contact with the printed-circuit board:

- For pitches of 15 mm capacitors shall be mechanically fixed by the leads
- For larger pitches the capacitors shall be mounted in the same way and the body clamped

**SPACE REQUIREMENTS ON PRINTED-CIRCUIT BOARD**

The maximum length and width of film capacitors is shown in Figure:

- Eccentricity as in Figure. The maximum eccentricity is smaller than or equal to the lead diameter of the product concerned.
- Product height with seating plane as given by "IEC 60717" as reference:  $h_{max} \leq h + 0.3 \text{ mm}$

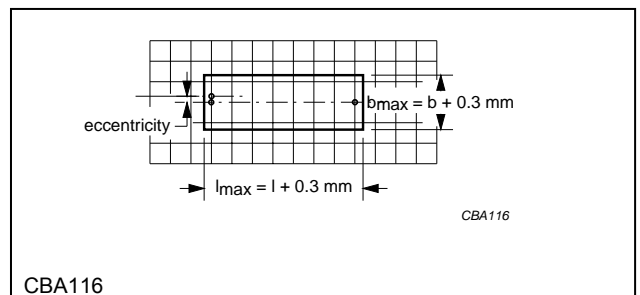

**RATINGS AND CHARACTERISTICS REFERENCE CONDITIONS**

Unless otherwise specified, all electrical values apply to an ambient temperature of  $23 \pm 1 \text{ }^\circ\text{C}$ , an atmospheric pressure of 86 to 106 kPa and a relative humidity of  $50 \pm 2\%$ .

For reference testing, a conditioning period shall be applied over  $96 \pm 4$  hours by heating the products in a circulating air oven at the rated temperature and a relative humidity not exceeding 20%.

**CHARACTERISTICS**  
Capacitance

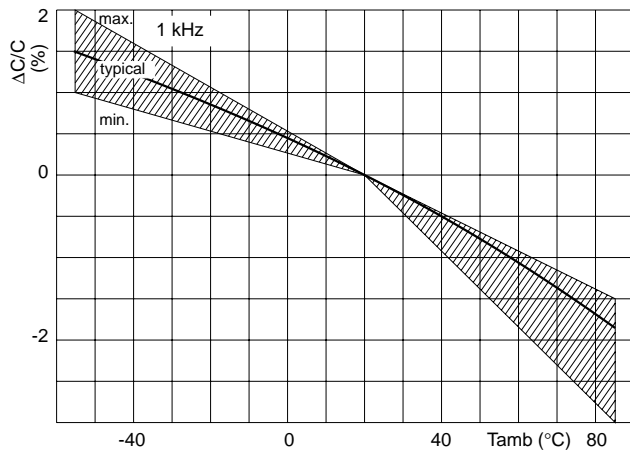

CBB828

**Impedance**

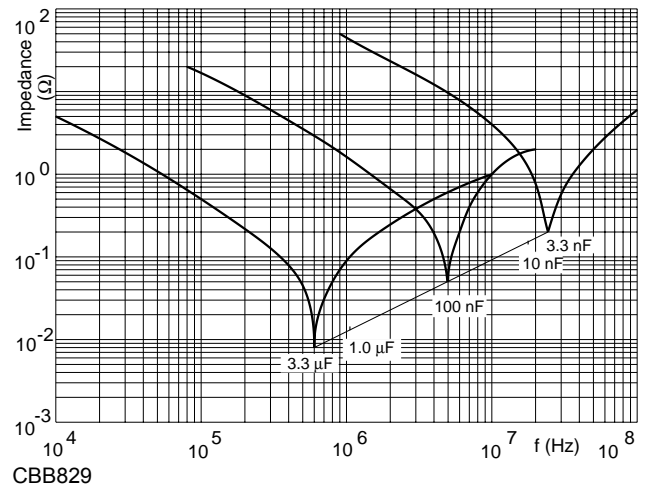

CBB829

**Max RMS voltage (sinewave) as a function of temperature**

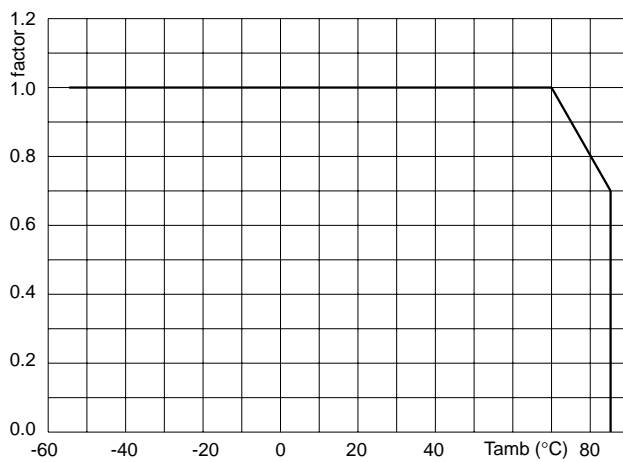

CBB960

**Max RMS voltage and AC current (sinewave)**

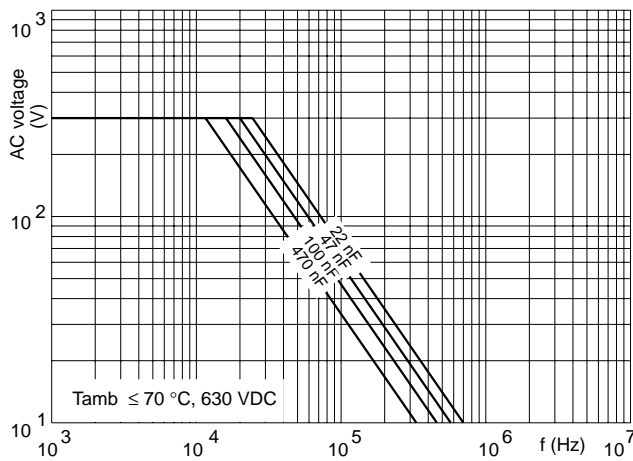

CBB824

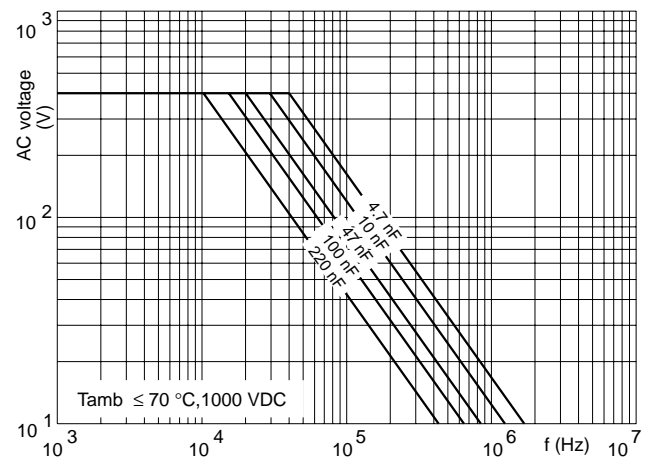

CBB825

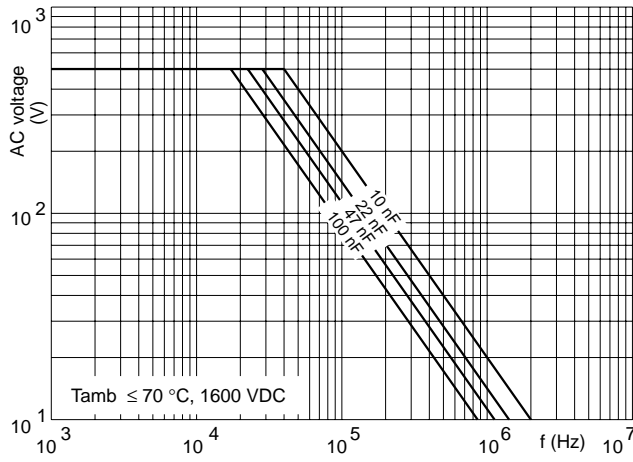

CBB826

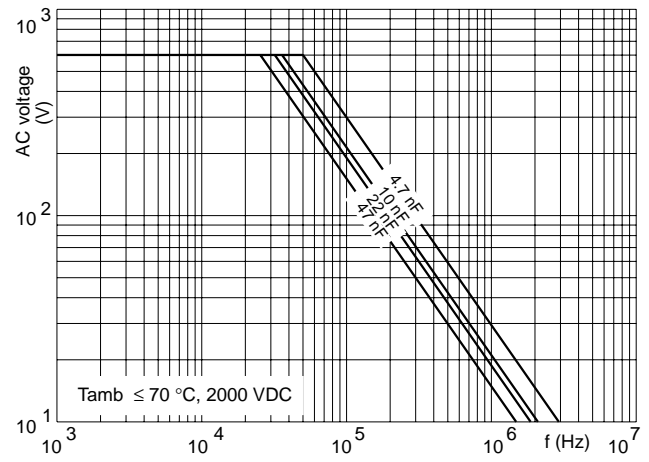

CBB827

**Maximum RMS current (sinewave) as a function of frequency**

The maximum RMS current is defined by  $I_{ac} = \omega \times C \times U_{ac}$ .

$U_{ac}$ : is the maximum AC voltage depending on the ambient temperature in the curves "Max RMS voltage and AC current as a function of frequency"

**Tangent of loss angle**

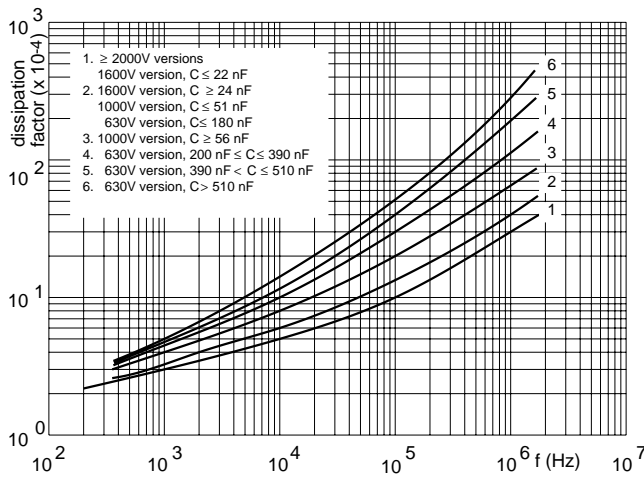

CBB959

**Insulation resistance**

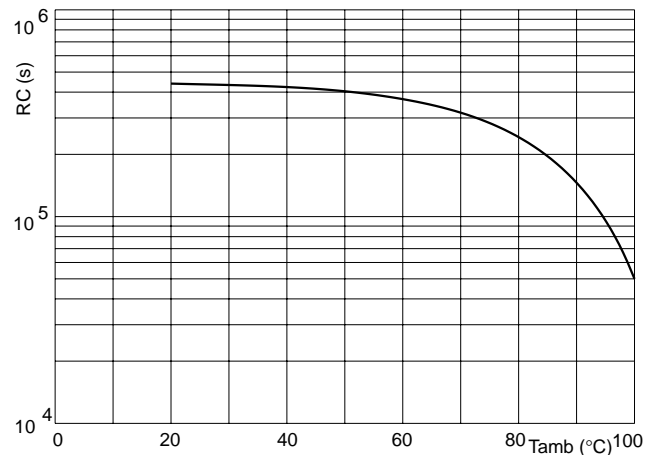

CBB840

**Maximum allowed component temperature rise ( $\Delta T$ ) as a function of the ambient temperature ( $T_{amb}$ )**

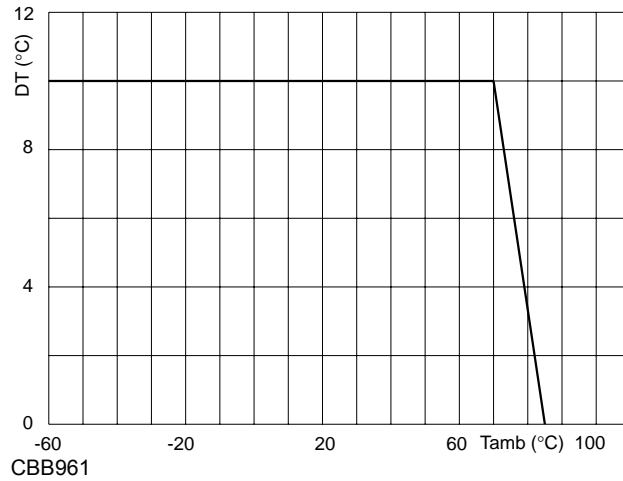

**HEAT CONDUCTIVITY (G) AS A FUNCTION OF (ORIGINAL) PITCH AND CAPACITOR BODY THICKNESS IN mW/°C**

$w_{max}$ (mm)	Heat conductivity (mW/°C)		
	Pitch 15 mm	Pitch 22.5 mm	Pitch 27.5 mm
4.0	-	-	-
5.0	10	-	-
6.0	11	19	-
7.0	12	21	-
8.5	16	25	-
10.0	18	28	-
11.0	-	-	36
13.0	-	-	42
15.0	-	-	48
18.0	-	-	57

**POWER DISSIPATION AND MAXIMUM COMPONENT TEMPERATURE RISE**

The power dissipation must be limited in order not to exceed the maximum allowed component temperature rise as a function of the free ambient temperature.

The power dissipation can be calculated according Type detail specification "HQN-384-01/101: Technical information film capacitors"

The component temperature rise ( $\Delta T$ ) can be measured (see Section "Measuring the component temperature" for more details) or calculated by  $\Delta T = P/G$ :

- $\Delta T$  = component temperature rise (°C)
- P = power dissipation of the component (mW)
- G = heat conductivity of the component (mW/°C)

	<b>METALLIZED POLYPROPYLENE FILM</b> <b>AC AND PULSE CAPACITOR</b> <b>MKP 378 MKP/MKP378</b> <b>MKP AND MKP/MKP RADIAL POTTED TYPE</b>	Doc. No: HQN-384-17/102
		Rev. : W
		Iss. Date: 2006-10-16
		Page 15 of 19

#### MEASURING THE COMPONENT TEMPERATURE

A thermocouple must be attached to the capacitor body as in:

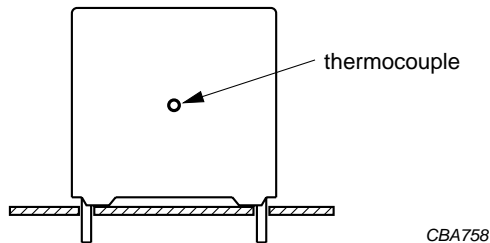

CBA758

CBA758

The temperature is measured in unloaded ( $T_{amb}$ ) and maximum loaded condition ( $T_c$ ).

The temperature rise is given by  $\Delta T = T_c - T_{amb}$ .

To avoid radiation or convection, the capacitor should be tested in a wind-free box.

#### APPLICATION NOTE AND LIMITING CONDITIONS

These capacitors are not suitable for mains applications as across-the-line capacitors without additional protection, as described hereunder. These mains applications are strictly regulated in safety standards and therefore electromagnetic interference suppression capacitors conforming the standards must be used.

To select the capacitor for a certain application, the following conditions must be checked:

1. The peak voltage ( $U_p$ ) shall not be greater than the rated DC voltage ( $U_{Rdc}$ )
2. The peak-to-peak voltage ( $U_{p-p}$ ) shall not be greater than the maximum  $U_{p-p}$  to avoid the ionisation inception level
3. The voltage peak slope ( $dU/dt$ ) shall not exceed the rated voltage pulse slope in an RC-circuit at rated voltage and without ringing. If the pulse voltage is lower than the rated DC voltage, the rated voltage pulse slope may be multiplied by  $U_{Rdc}$  and divided by the applied voltage.

For all other pulses following equation must be fulfilled:

$$2 \times \int_0^T \left( \frac{dU}{dt} \right)^2 \times dt < U_{Rdc} \times \left( \frac{dU}{dt} \right)_{rated}$$

T is the pulse duration

The rated voltage pulse slope is valid for ambient temperatures up to 70 °C. For higher temperatures a derating factor of 3% per K shall be applied

4. The maximum component surface temperature rise must be lower than the limits (see figure max allowed component temp rise)
5. Since in circuits used at voltages over 280V peak-to-peak the risk for an intrinsically active flammability after a capacitor breakdown (short circuit) increases, it is recommended that the power to the component is limited to 100 times the values mentioned in the table: "Heat conductivity"
6. When using these capacitors as across-the-line capacitor in the input filter for mains applications or as series connected with an impedance to the mains the applicant must guarantee that the following conditions are fulfilled in any case (spikes and surge voltages from the mains included).

#### VOLTAGE CONDITIONS FOR 6 ABOVE

ALLOWED VOLTAGES	$T_{amb} \leq 70 \text{ }^\circ\text{C}$	$70 \text{ }^\circ\text{C} < T_{amb} \leq 85 \text{ }^\circ\text{C}$
Maximum continuous RMS voltage	$U_{Rac}$	$0.7 \times U_{Rac}$
Maximum temperature RMS-overvoltage (<24 hours)	$1.25 \times U_{Rac}$	$0.875 \times U_{Rac}$
Maximum peak voltage ( $V_{o-p}$ ) (<2s)	$1.6 \times U_{Rdc}$	$1.1 \times U_{Rdc}$

**Example**

C = 470 nF -630V used for S-correction. This is the signal shown in next figure.

$U_{p-p} = 108V$ ;  $U_p = 170V$ ;  $T_1 = 12\mu s$ ;  $T_2 = 64\mu s$ ;  $I_{p-p} = 5A$

The ambient temperature is 50 °C

Checking conditions:

1. The peak voltage  $U_p = 170V$  is lower than 630 V (DC)
2. The peak-to-peak voltage 108V is lower than  $2\sqrt{2} \times 300V$  (AC) = 850  $U_{p-p}$
3.  $I_p = 2.5A$  is lower than  $0.47 \mu F \times 370 V/\mu s = 174 A$
4. The dissipated power is 40 mW as calculated with Fourier terms and tdg maximum values  
This gives a temperature rise of  $40 mW / 48 mW/^\circ C = 0.8 ^\circ C$   
This is allowed according figure max allowed component temp rise
5. Depends on actual application
6. Not applicable

Voltage signal:

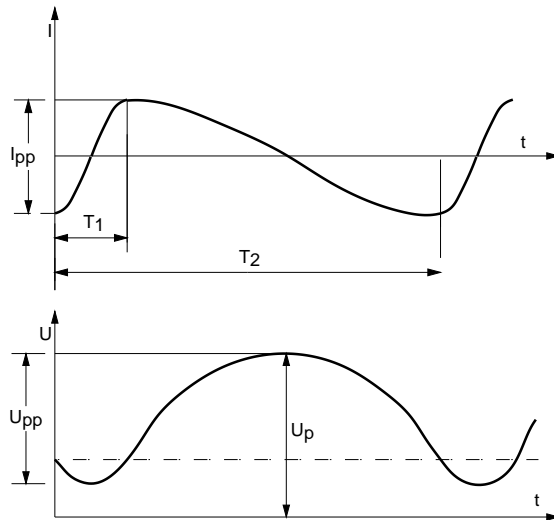

CBA279

CBA279



**MARKING**

**Product marking**

The capacitors are marked by laser print on the top or head face (see figures) with the following information:

1. Rated capacitance code in accordance with "IEC 60062"
2. Tolerance on rated capacitance; J=±5%
3. Rated (DC) voltage (e.g.1000 V)
4. Manufacturer's type designation (e.g.378)
5. Code for dielectric material (MKP /MKP)
6. Manufacturers name
7. Code for factory of origin: R: Roeselare
8. Year and week of manufacture (e.g. 0516)

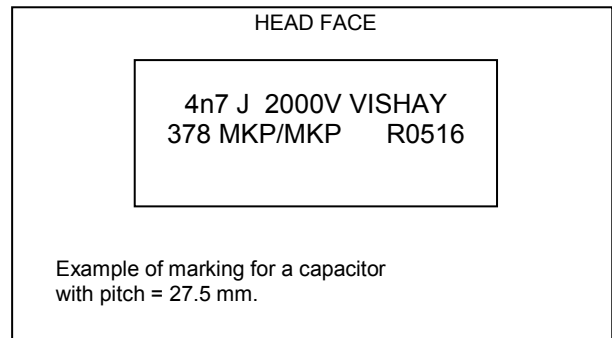
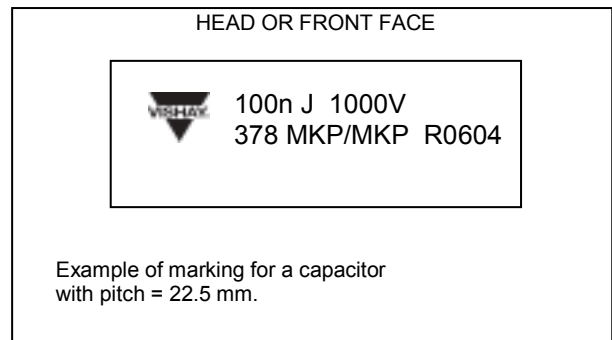
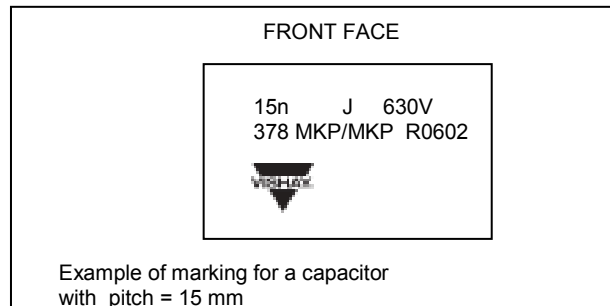

**Package marking**

The package containing the capacitors is marked as shown



LB990160

**Barcode label marking**

LINE	MARKING EXPLANATION
1	Manufacturer's name
2	Country of origin
3	Sub-family
4	Type description
5	Capacitance value, tolerance, voltage and Climatic category ("IEC 60068-1")
6	-
7	Preference origin code: A Country of origin in code: 170 (Belgium) Responsible production centre: R
8	Product type description
9	Batch code
10	Quantity and production period, year and week code
11	Product code (12NC)

	<b>METALLIZED POLYPROPYLENE FILM</b> <b>AC AND PULSE CAPACITOR</b> <b>MKP 378 MKP/MKP378</b> <b>MKP AND MKP/MKP RADIAL POTTED TYPE</b>	Doc. No: HQN-384-17/102
		Rev. : W
		Iss. Date: 2006-10-16
		Page 18 of 19

**QUICK REFERENCE TEST REQUIREMENTS**

TEST	PROCEDURE (quick reference)	REQUIREMENTS
<b>Robustness of leads</b>		
Tensile and bending: "IEC 60068-2-21"	-	No visible change Ligible marking
Resistance to soldering heat: "IEC 60068-2-20"	Solder bath: 260 °C; 10 s	$ \Delta C/C  \leq 1\%$ $\Delta \tan \delta \leq 5 \times 10^{-4}$ ( $C \leq 100$ nF) $\Delta \tan \delta \leq 10 \times 10^{-4}$ ( $100$ nF < $C \leq 470$ nF) $\Delta \tan \delta \leq 15 \times 10^{-4}$ ( $C > 470$ nF)
Component solvent resistance	Isopropyl alcohol; 23 °C; 5 minutes	
<b>Robustness of component</b>		
Vibration: "IEC 60068-2-6"	10 to 55 Hz; amplitude 0.75 mm or acceleration 98 m/s <sup>2</sup> ; 6 hours	$ \Delta C/C  \leq 1\%$ $\Delta \tan \delta \leq 5 \times 10^{-4}$ ( $C \leq 100$ nF) $\Delta \tan \delta \leq 10 \times 10^{-4}$ ( $100$ nF < $C \leq 470$ nF) $\Delta \tan \delta \leq 15 \times 10^{-4}$ ( $C > 470$ nF)
Shock: "IEC 60068-2-27"	Half sinewave; 490 m/s <sup>2</sup> ; 11 ms	
<b>Climatic sequence</b>		
Dry heat: "IEC 60068-2-2"	16 hours; 85 °C	$ \Delta C/C  \leq 1\%$ (22.5/27.5 mm pitch) $ \Delta C/C  \leq 2\%$ (15 mm pitch) $\Delta \tan \delta \leq 5 \times 10^{-4}$ ( $C \leq 100$ nF) $\Delta \tan \delta \leq 10 \times 10^{-4}$ ( $100$ nF < $C \leq 470$ nF) $\Delta \tan \delta \leq 15 \times 10^{-4}$ ( $C > 470$ nF)
Damp heat, cyclic, test Db, First cycle: "IEC 60068-2-30"		
Cold: "IEC 60068-2-1"	2 hours; -55 °C	$R_{ins} \geq 50\%$ of specified value
Damp heat, cyclic, test Db, Remaining cycles: "IEC 60068-2-30"		
<b>Other applicable tests</b>		
Damp heat, steady state: "IEC 60068-2-3"	56 days; 40 °C 90 to 95 % RH	$ \Delta C/C  \leq 1\%$ (22.5/27.5 mm pitch) $ \Delta C/C  \leq 2\%$ (15 mm pitch) $\Delta \tan \delta \leq 5 \times 10^{-4}$ ( $C \leq 100$ nF) $\Delta \tan \delta \leq 10 \times 10^{-4}$ ( $100$ nF < $C \leq 470$ nF) $\Delta \tan \delta \leq 15 \times 10^{-4}$ ( $C > 470$ nF) $R_{ins} \geq 50\%$ of specified value
Endurance (AC): "IEC 60384-17"	1000 hours; 85°C 1.25 x U <sub>Rac</sub> (RMS); 50 Hz	
Heat storage: "IEC 60384-17"	2000 hours; 85 °C	$ \Delta C/C  \leq 1\%$ (22.5/27.5 mm pitch) $ \Delta C/C  \leq 2\%$ (15 mm pitch) $\Delta \tan \delta \leq 5 \times 10^{-4}$ ( $C \leq 100$ nF) $\Delta \tan \delta \leq 10 \times 10^{-4}$ ( $100$ nF < $C \leq 470$ nF) $\Delta \tan \delta \leq 15 \times 10^{-4}$ ( $C > 470$ nF)
Resistance to soldering heat with preheating: "IEC 60384-17"	Preheating: 85 °C Solder bath: 260°C; 10 s	
Passive flammability "IEC 60384-1"	Class B	No burning
Endurance (DC): "IEC 60384-17"	2000 hours; 85°C 1.25 x U <sub>Rdc</sub>	$ \Delta C/C  \leq 1\%$ (22.5/27.5 mm pitch) $ \Delta C/C  \leq 2\%$ (15 mm pitch) $\Delta \tan \delta \leq 5 \times 10^{-4}$ ( $C \leq 100$ nF) $\Delta \tan \delta \leq 10 \times 10^{-4}$ ( $100$ nF < $C \leq 470$ nF) $\Delta \tan \delta \leq 15 \times 10^{-4}$ ( $C > 470$ nF) $R_{ins} \geq 50\%$ of specified value

	<b>METALLIZED POLYPROPYLENE FILM</b> <b>AC AND PULSE CAPACITOR</b> <b>MKP 378 MKP/MKP378</b> <b>MKP AND MKP/MKP RADIAL POTTED TYPE</b>	Doc. No: HQN-384-17/102
		Rev. : W
		Iss. Date: 2006-10-16
		Page 19 of 19

History (Publisher: Roeselare)

Revision	Description	Date
A	First issue	1992-02-25
B	New layout	1993-05-04
C	P27 HQ2285K: change from taping method from one tape to two small tapes	1993-08-24
D	Different corrections, add of reference testing	1993-10-19
E	P36:sub-group ADD4: A4 body temp 85°C iso 80°C	1994-01-11
F	P13: 2000V: cap range 0.016-0.051 AFD, add of mass	1994-03-22
G	Lead diameter 0.8± 0.08mm	1994-04-19
H	Adj of ADD2 and ADD6; adj of 630 and 1000V pitch 15mm; new layout	1995-02-07
I	Add of 2222 378 44....: MKP 250V -Lt=3.5± 0.5mm; Add of 2222 378 54....: MKP 400V -Lt=3.5± 0.5mm	1996-02-06
J	New layout and renumbering tests (WV-HQ7012K); test "solvent resistance of marking" before "rapid change of temp" (WV-HQ6140K)	1997-09-16
K	P8->19: adj of header MKP/MKP iso MKP378	1998-03-17
L	Pitch 27.5mm: taped on reel products no longer available (WV-HQ8060K); MKP lt=3.5± 0.3mm iso lt=3.5± 0.5mm; lt=3.2± 0.5mm is cancelled (WV-HQ8092 and 6117K)	1998-05-26
M	Adj of product marking and label (WV-HQ9128K); Philips becomes BC Components	1999-12-07
N	Adj of package quantities; BC Beyschlag Centralab Components becomes BCcomponents (WV-HQ0011K)	2000-02-15
O	Case 1770-1785 becomes copper wire (WV-HQ0066K)	2000-05-09
P	Add if there must be a voltage proof test after damp heat test (WV-HQ0198K); adj of delta C/C in ADD6 test (WV-HQ0240K)	2000-12-05
Q	Replacement of AQL 0.65% by zero defect (WV-HQ0252K); pass flammability becomes class B iso C (WV-HQ01009K)	2001-10-23
R	Corr passive flammability test	2001-12-11
S	Adj of packing quantities for case 2560 (WV-HQ01132K)	2003-02-18
T	Transition to Word, Vishay logo, code of origin R iso HQ (CP03168); inspection requirements in TPD191; Lead 0.6 mm iso 0.8 mm for cases 1750 and 1760 (CP-R04072);jedec symbols on label (CP-R04130), label completely Pb free products (CP-R04130 & CP-R05012); VISHAY iso Vishay on label (CP-R05052); add e3 symbol in text and add RoHS compliant (CP-R05053)	2005-03-29
U	Corrections: Urdc iso Urac in tables, above capacitance values.	2005-12-20
V	CO2->YAG 15mm and 22.5mm (CP R05164 & CP R06026); BFC2 code; change position batch code on label (CP R06080). P. 8: correction quantity loose in box for case size 1760 -> 1000 iso 1100.	2006-06-20
W	Correction : Voltage for 250V and 400V products (CP R06130), correction weights (CP R06005); Wire not specified	2006-10-16