

PDP SWITCH

IRFI4229PbF

Features

- Advanced Process Technology
- Key Parameters Optimized for PDP Sustain, Energy Recovery and Pass Switch Applications
- Low E_{PULSE} Rating to Reduce Power Dissipation in PDP Sustain, Energy Recovery and Pass Switch Applications
- Low Q_G for Fast Response
- High Repetitive Peak Current Capability for Reliable Operation
- Short Fall & Rise Times for Fast Switching
- 150°C Operating Junction Temperature for Improved Ruggedness
- Repetitive Avalanche Capability for Robustness and Reliability

Key Parameters		
V_{DS} max	250	V
V_{DS} (Avalanche) typ.	300	V
$R_{DS(ON)}$ typ. @ 10V	38	mΩ
I_{RP} max @ $T_C = 100^\circ\text{C}$	32	A
T_J max	150	°C

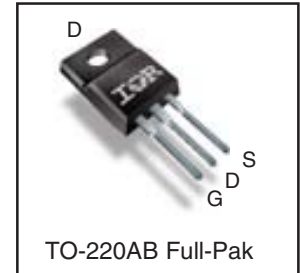
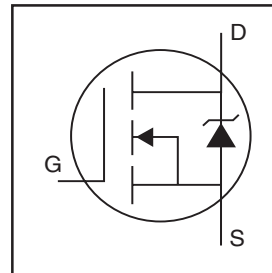

G	D	S
Gate	Drain	Source

Description

This HEXFET® Power MOSFET is specifically designed for Sustain; Energy Recovery & Pass switch applications in Plasma Display Panels. This MOSFET utilizes the latest processing techniques to achieve low on-resistance per silicon area and low E_{PULSE} rating. Additional features of this MOSFET are 150°C operating junction temperature and high repetitive peak current capability. These features combine to make this MOSFET a highly efficient, robust and reliable device for PDP driving applications.

Absolute Maximum Ratings

	Parameter	Max.	Units
V_{GS}	Gate-to-Source Voltage	±30	V
I_D @ $T_C = 25^\circ\text{C}$	Continuous Drain Current, V_{GS} @ 10V	19	A
I_D @ $T_C = 100^\circ\text{C}$	Continuous Drain Current, V_{GS} @ 10V	12	
I_{DM}	Pulsed Drain Current ①	72	
I_{RP} @ $T_C = 100^\circ\text{C}$	Repetitive Peak Current ⑤	32	W
P_D @ $T_C = 25^\circ\text{C}$	Power Dissipation	46	
P_D @ $T_C = 100^\circ\text{C}$	Power Dissipation	18	
	Linear Derating Factor	0.37	W/°C
T_J	Operating Junction and Storage Temperature Range	-40 to + 150	°C
T_{STG}			
	Soldering Temperature for 10 seconds	300	
	Mounting Torque, 6-32 or M3 Screw	10lb·in (1.1N·m)	N

Thermal Resistance

	Parameter	Typ.	Max.	Units
$R_{\theta JC}$	Junction-to-Case ④	—	2.73	°C/W
$R_{\theta JA}$	Junction-to-Ambient ④	—	65	

Notes ① through ⑤ are on page 8

Electrical Characteristics @ $T_J = 25^\circ\text{C}$ (unless otherwise specified)

	Parameter	Min.	Typ.	Max.	Units	Conditions
BV_{DSS}	Drain-to-Source Breakdown Voltage	250	—	—	V	$V_{GS} = 0V, I_D = 250\mu A$
$\Delta BV_{DSS}/\Delta T_J$	Breakdown Voltage Temp. Coefficient	—	340	—	mV/°C	Reference to $25^\circ\text{C}, I_D = 1mA$
$R_{DS(on)}$	Static Drain-to-Source On-Resistance	—	38	46	mΩ	$V_{GS} = 10V, I_D = 11A$ ③
$V_{GS(th)}$	Gate Threshold Voltage	3.0	—	5.0	V	$V_{DS} = V_{GS}, I_D = 250\mu A$
$\Delta V_{GS(th)}/\Delta T_J$	Gate Threshold Voltage Coefficient	—	-12	—	mV/°C	
I_{DSS}	Drain-to-Source Leakage Current	—	—	20	μA	$V_{DS} = 250V, V_{GS} = 0V$
		—	—	200		$V_{DS} = 250V, V_{GS} = 0V, T_J = 125^\circ\text{C}$
I_{GSS}	Gate-to-Source Forward Leakage	—	—	100	nA	$V_{GS} = 20V$
	Gate-to-Source Reverse Leakage	—	—	-100		$V_{GS} = -20V$
g_{fs}	Forward Transconductance	26	—	—	S	$V_{DS} = 25V, I_D = 11A$
Q_g	Total Gate Charge	—	73	110	nC	$V_{DD} = 125V, I_D = 11A, V_{GS} = 10V$ ③
Q_{gd}	Gate-to-Drain Charge	—	24	—		
$t_{d(on)}$	Turn-On Delay Time	—	18	—	ns	$V_{DD} = 125V, V_{GS} = 10V$ ③ $I_D = 11A$ $R_G = 2.4\Omega$ See Fig. 22
t_r	Rise Time	—	17	—		
$t_{d(off)}$	Turn-Off Delay Time	—	32	—		
t_f	Fall Time	—	13	—		
t_{st}	Shoot Through Blocking Time	100	—	—	ns	$V_{DD} = 200V, V_{GS} = 15V, R_G = 5.1\Omega$
E_{PULSE}	Energy per Pulse	—	770	—	μJ	$L = 220nH, C = 0.3\mu F, V_{GS} = 15V$ $V_{DS} = 200V, R_G = 5.1\Omega, T_J = 25^\circ\text{C}$
		—	1380	—		$L = 220nH, C = 0.3\mu F, V_{GS} = 15V$ $V_{DS} = 200V, R_G = 5.1\Omega, T_J = 100^\circ\text{C}$
C_{iss}	Input Capacitance	—	4480	—	pF	$V_{GS} = 0V$
C_{oss}	Output Capacitance	—	400	—		$V_{DS} = 25V$
C_{riss}	Reverse Transfer Capacitance	—	100	—		$f = 1.0MHz,$
$C_{oss\ eff.}$	Effective Output Capacitance	—	270	—		$V_{GS} = 0V, V_{DS} = 0V \text{ to } 200V$
L_D	Internal Drain Inductance	—	4.5	—	nH	Between lead, 6mm (0.25in.) from package and center of die contact
L_S	Internal Source Inductance	—	7.5	—		

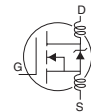

Avalanche Characteristics

	Parameter	Typ.	Max.	Units
E_{AS}	Single Pulse Avalanche Energy ②	—	110	mJ
E_{AR}	Repetitive Avalanche Energy ①	—	4.6	mJ
$V_{DS(Avalanche)}$	Repetitive Avalanche Voltage ①	300	—	V
I_{AS}	Avalanche Current ②	—	11	A

Diode Characteristics

	Parameter	Min.	Typ.	Max.	Units	Conditions
$I_S @ T_C = 25^\circ\text{C}$	Continuous Source Current (Body Diode)	—	—	18	A	MOSFET symbol showing the integral reverse p-n junction diode.
I_{SM}	Pulsed Source Current (Body Diode) ①	—	—	72		
V_{SD}	Diode Forward Voltage	—	—	1.3	V	$T_J = 25^\circ\text{C}, I_S = 11A, V_{GS} = 0V$ ③
t_{rr}	Reverse Recovery Time	—	120	180	ns	$T_J = 25^\circ\text{C}, I_F = 11A, V_{DD} = 50V$
Q_{rr}	Reverse Recovery Charge	—	540	810	nC	$di/dt = 100A/\mu s$ ③

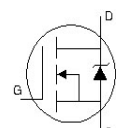

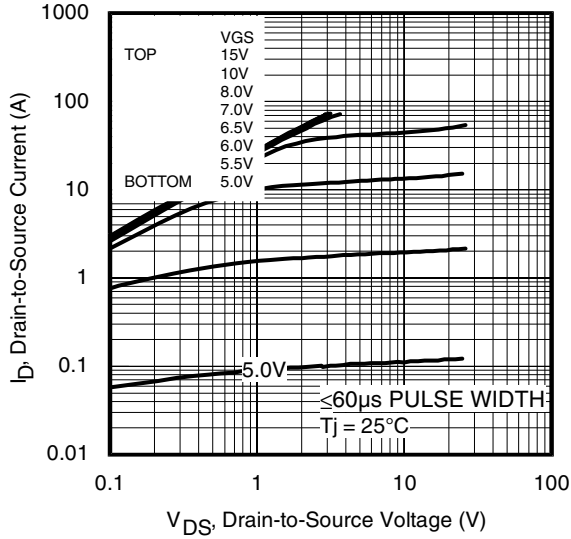

Fig 1. Typical Output Characteristics

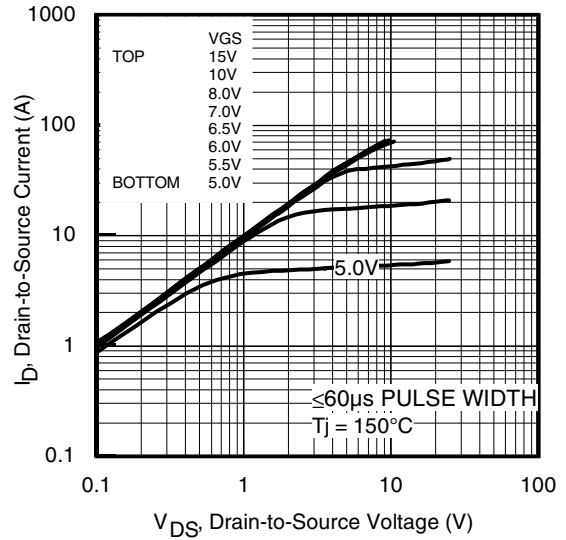

Fig 2. Typical Output Characteristics

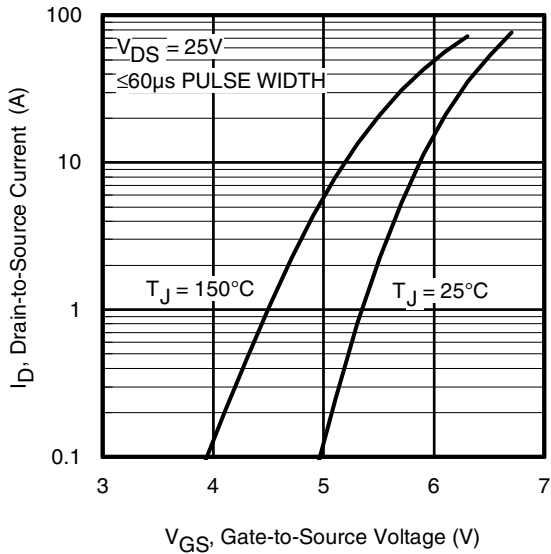

Fig 3. Typical Transfer Characteristics

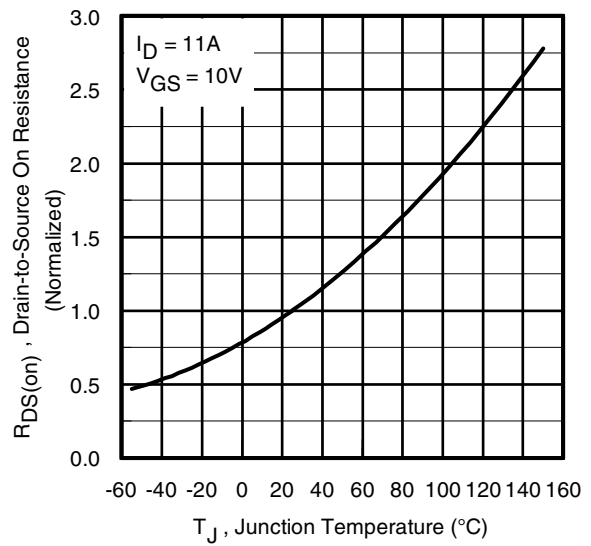

Fig 4. Normalized On-Resistance vs. Temperature

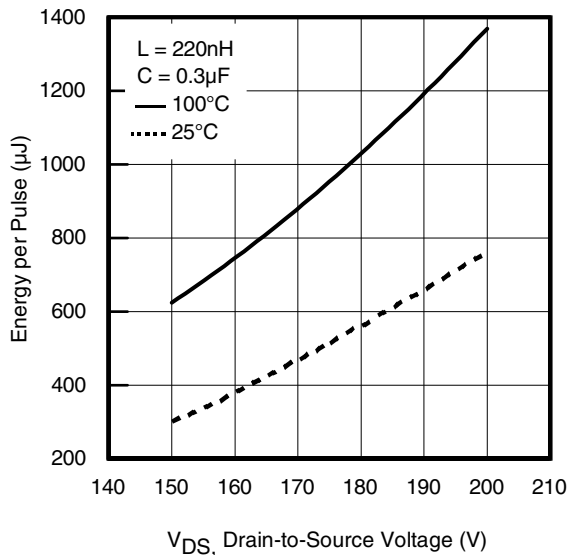

Fig 5. Typical E_{PULSE} vs. Drain-to-Source Voltage

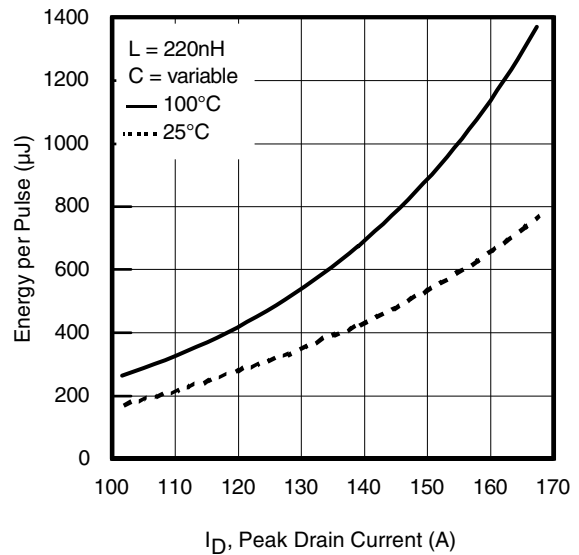

Fig 6. Typical E_{PULSE} vs. Drain Current

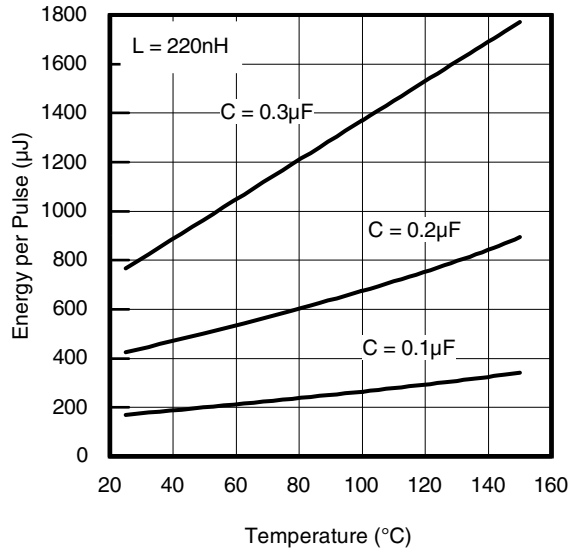

Fig 7. Typical E_{PULSE} vs. Temperature

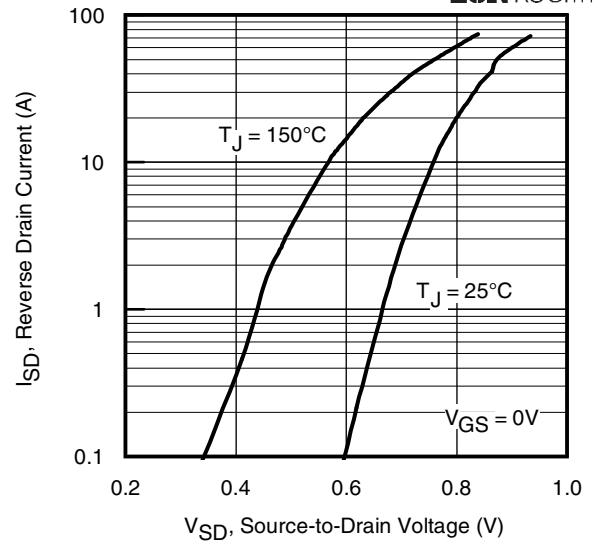

Fig 8. Typical Source-Drain Diode Forward Voltage

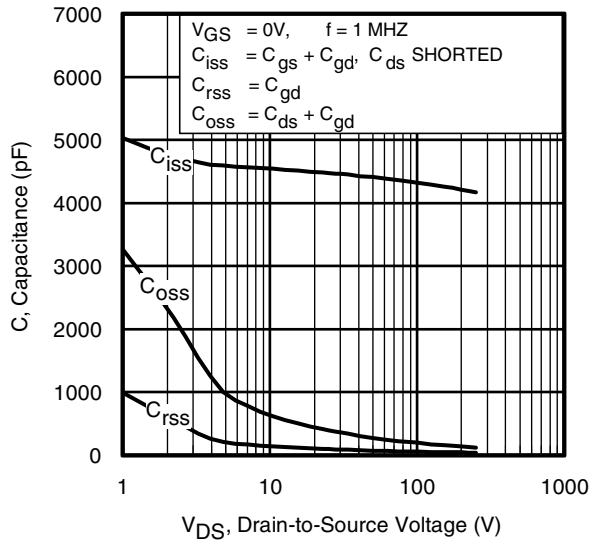

Fig 9. Typical Capacitance vs. Drain-to-Source Voltage

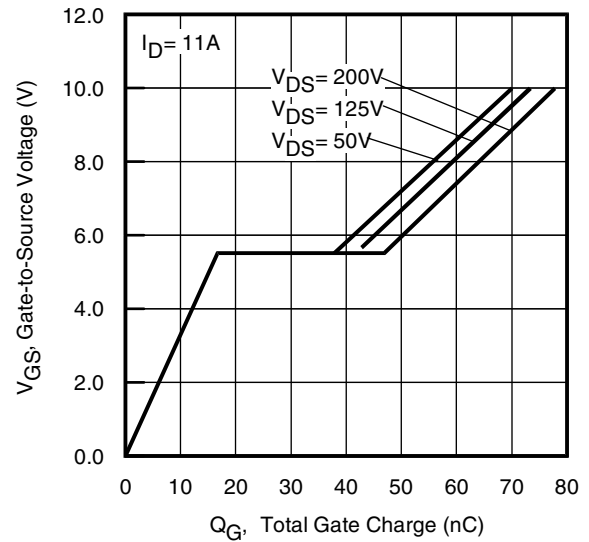

Fig 10. Typical Gate Charge vs. Gate-to-Source Voltage

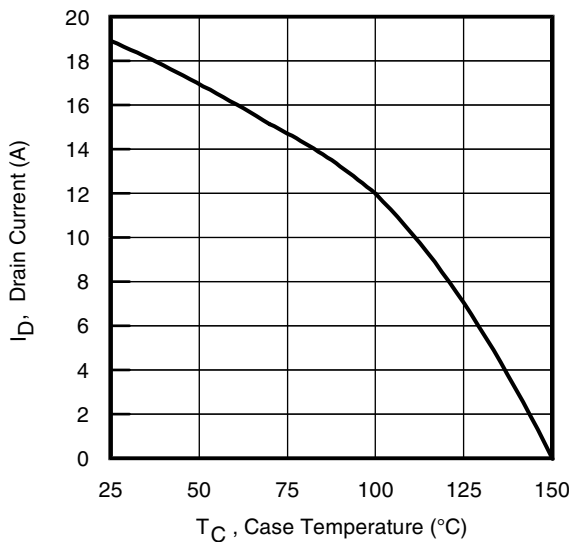

Fig 11. Maximum Drain Current vs. Case Temperature

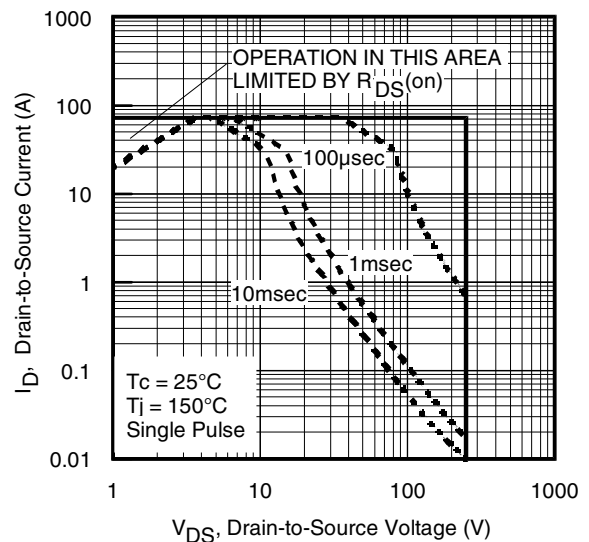

Fig 12. Maximum Safe Operating Area

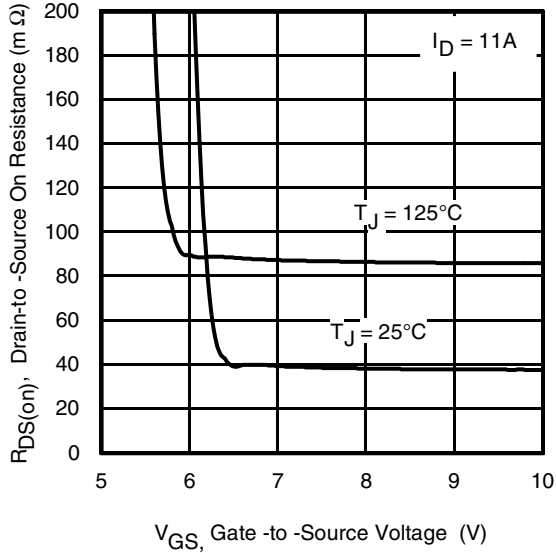

Fig 13. On-Resistance vs. Gate Voltage

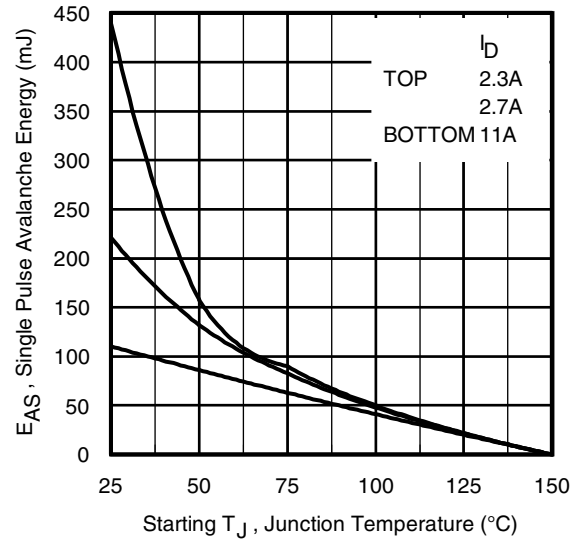

Fig 14. Maximum Avalanche Energy vs. Temperature

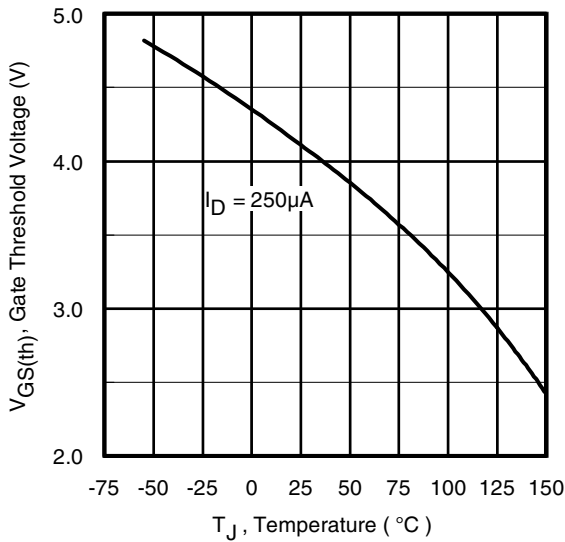

Fig 15. Threshold Voltage vs. Temperature

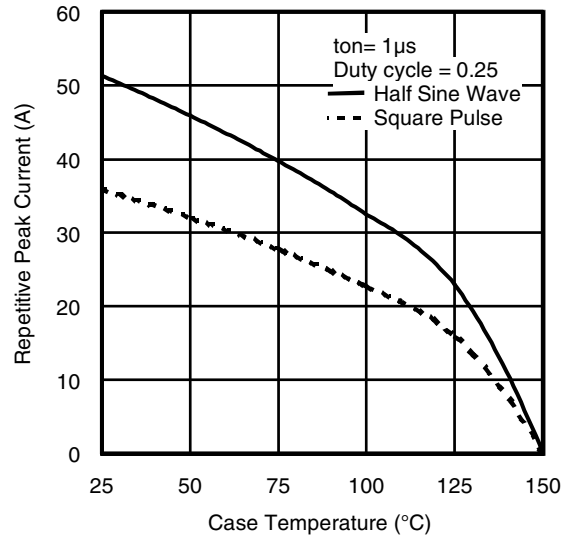

Fig 16. Typical Repetitive peak Current vs. Case temperature

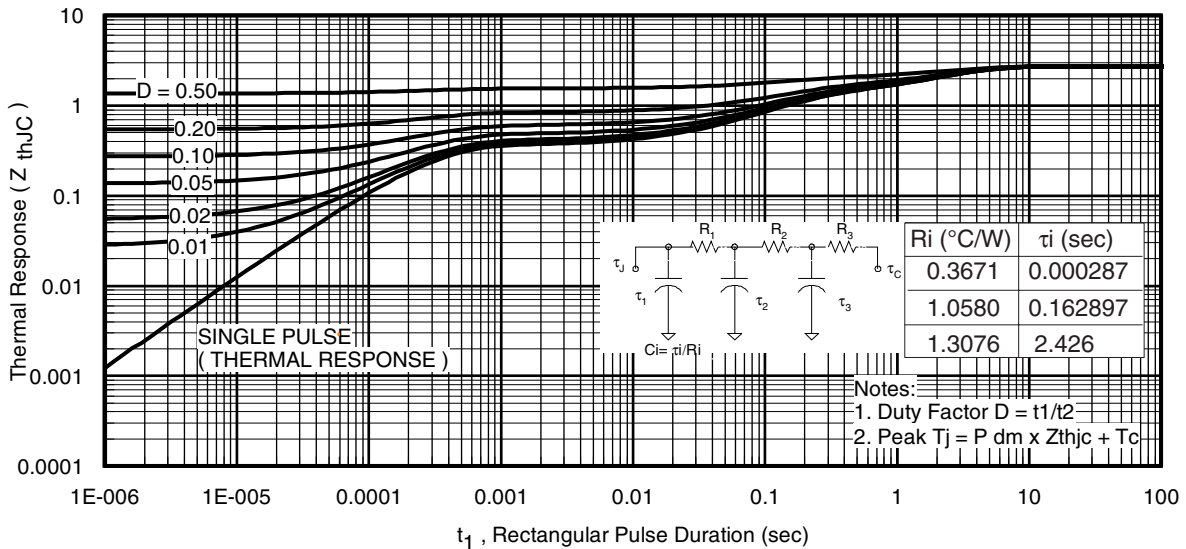

Fig 17. Maximum Effective Transient Thermal Impedance, Junction-to-Case

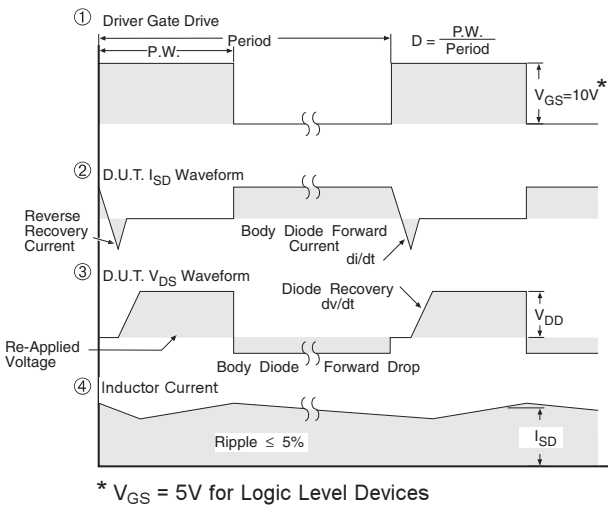
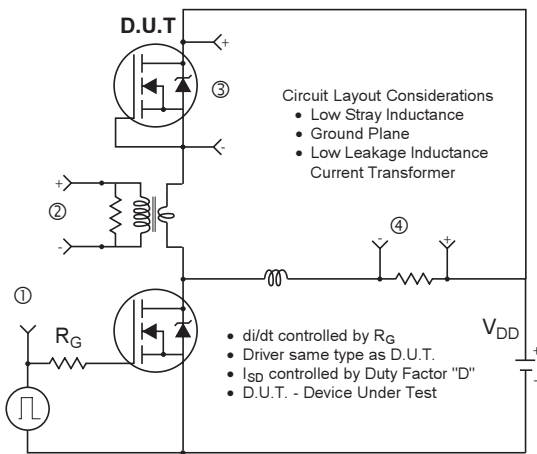

Fig 18. Diode Reverse Recovery Test Circuit for N-Channel HEXFET® Power MOSFETs

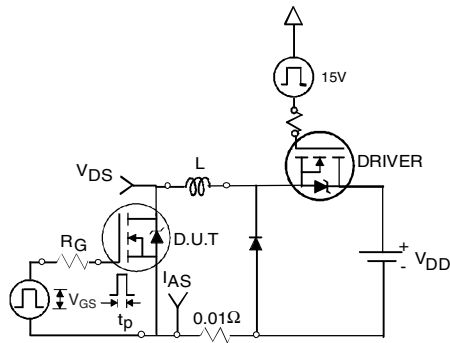

Fig 19a. Unclamped Inductive Test Circuit

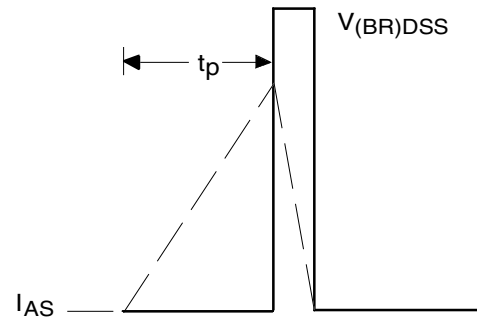

Fig 19b. Unclamped Inductive Waveforms

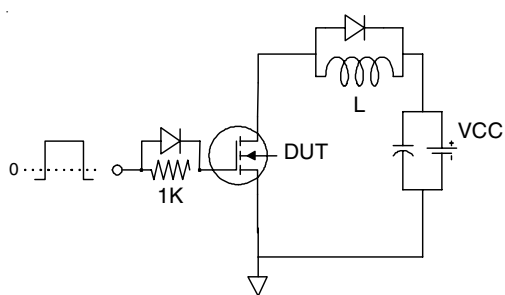

Fig 20a. Gate Charge Test Circuit

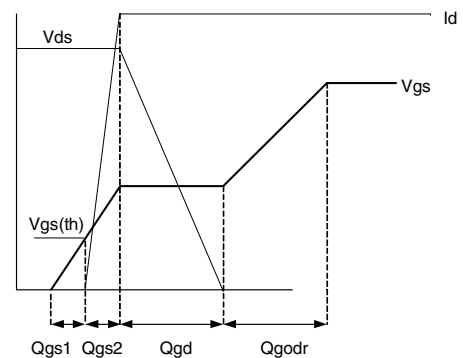

Fig 20b. Gate Charge Waveform

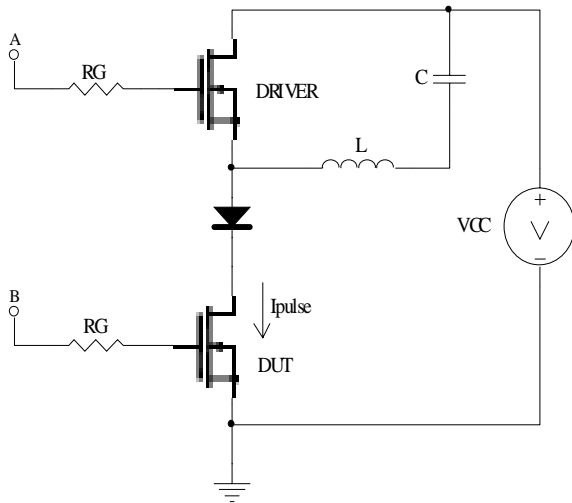

Fig 21a. t_{st} and E_{PULSE} Test Circuit

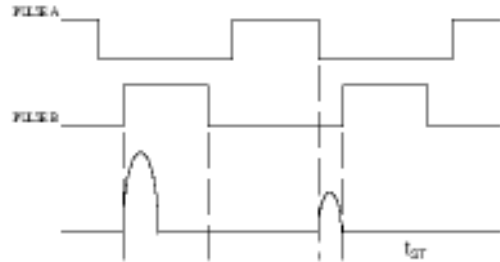

Fig 21b. t_{st} Test Waveforms

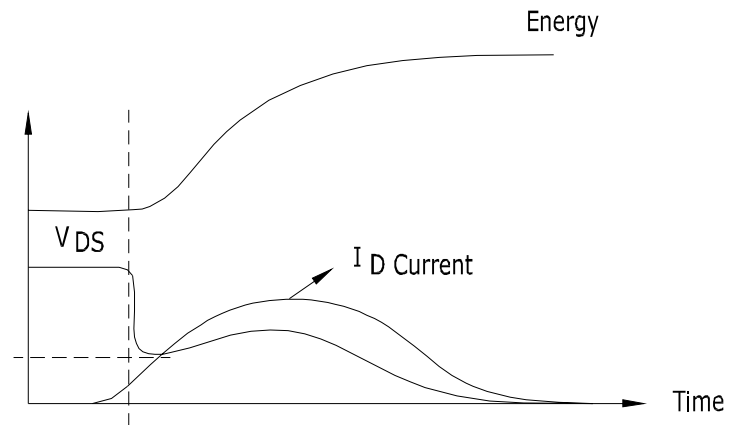

Fig 21c. E_{PULSE} Test Waveforms

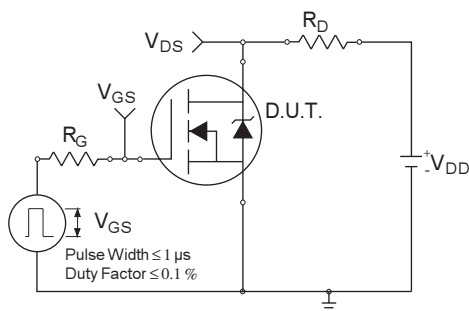

Fig 22a. Switching Time Test Circuit

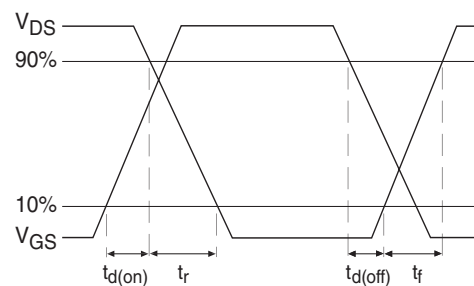
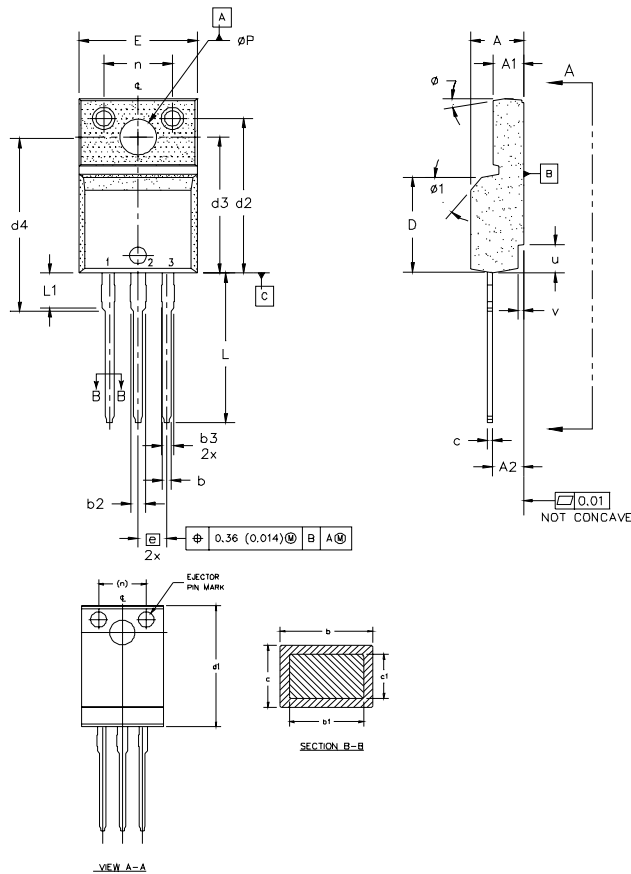

Fig 22b. Switching Time Waveforms

IRFI4229PbF

TO-220AB Full-Pak Package Outline (Dimensions are shown in millimeters (inches))



NOTES:

- 1.0 DIMENSIONING AND TOLERANCING PER ASME Y14.5 M- 1994.
- 2.0 DIMENSIONS ARE SHOWN IN MILLIMETERS [INCHES].
- 3.0 LEAD DIMENSION AND FINISH UNCONTROLLED IN L1.
- 4.0 DIMENSION D & E DO NOT INCLUDE MOLD FLASH. MOLD FLASH SHALL NOT EXCEED 0.005" (0.127) PER SIDE. THESE DIMENSIONS ARE MEASURED AT THE OUTERMOST EXTREMES OF THE PLASTIC BODY.
- 5.0 DIMENSION b1 APPLY TO BASE METAL ONLY.
- 6.0 STEP OPTIONAL ON PLASTIC BODY DEFINED BY DIMENSIONS u & v.
- 7.0 CONTROLLING DIMENSION : INCHES.

SYMBOL	DIMENSIONS				NOTES	LEAD ASSIGNMENTS
	MILLIMETERS		INCHES			
	MIN.	MAX.	MIN.	MAX.		
A	4.57	4.83	0.180	0.190		
A1	2.57	2.83	0.101	0.114		
A2	2.51	2.85	0.099	0.112		
b	0.622	0.89	0.024	0.035		
b1	0.622	0.838	0.024	0.033	5	1.- GATE 2.- DRAIN 3.- SOURCE
b2	1.229	1.400	0.048	0.055		
b3	1.229	1.400	0.048	0.055		
c	0.440	0.629	0.017	0.025		
c1	0.440	0.584	0.017	0.023		
D	8.65	9.80	0.341	0.386	4	
d1	15.80	16.12	0.622	0.635		
d2	13.97	14.22	0.550	0.560		
d3	12.30	12.92	0.484	0.509		
d4	8.64	9.91	0.340	0.390		
E	10.36	10.63	0.408	0.419	4	
e	2.54 BSC		0.100 BSC			
L	13.20	13.73	0.520	0.541		
L1	3.10	3.50	0.122	0.138	3	
n	6.05	6.15	0.238	0.242		
nP	3.05	3.45	0.120	0.136		
u	2.40	2.50	0.094	0.098	6	
v	0.40	0.50	0.016	0.020	6	
φ	3°	7°	3°	7°		
φ1		45°		45°		

TO-220AB Full-Pak Part Marking Information

EXAMPLE: THIS IS AN IRFI840G
WITH ASSEMBLY
LOT CODE 3432
ASSEMBLED ON WW 24, 2001
IN THE ASSEMBLY LINE 'K'

Note: 'P' in assembly line position
indicates 'Lead-Free'

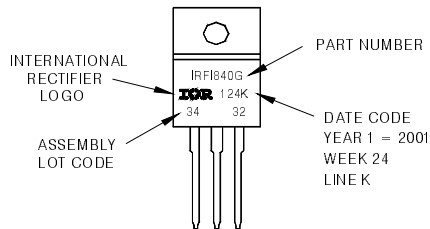

TO-220AB Full-Pak packages are not recommended for Surface Mount Application.

Notes:

- ① Repetitive rating; pulse width limited by max. junction temperature.
- ② Starting $T_J = 25^\circ\text{C}$, $L = 1.9\text{mH}$, $R_G = 25\Omega$, $I_{AS} = 11\text{A}$.
- ③ Pulse width $\leq 400\mu\text{s}$; duty cycle $\leq 2\%$.
- ④ R_θ is measured at T_J of approximately 90°C .
- ⑤ Half sine wave with duty cycle = 0.25, $t_{on} = 1\mu\text{sec}$.

Note: For the most current drawing please refer to IR website at: <http://www.irf.com/package/>

Data and specifications subject to change without notice.
This product has been designed and qualified for the Industrial market.
Qualification Standards can be found on IR's Web site.