

MJ15023 (PNP), MJ15025 (PNP)

Silicon Power Transistors

The MJ15023 and MJ15025 are power transistors designed for high power audio, disk head positioners and other linear applications.

Features

- High Safe Operating Area
- High DC Current Gain
- Complementary to MJ15022 (NPN), MJ15024 (NPN)
- These Devices are Pb-Free and are RoHS Compliant*

MAXIMUM RATINGS

Rating	Symbol	Value	Unit
Collector-Emitter Voltage MJ15023 MJ15025	V_{CEO}	200 250	Vdc
Collector-Base Voltage MJ15023 MJ15025	V_{CBO}	350 400	Vdc
Emitter-Base Voltage	V_{EBO}	5	Vdc
Collector-Emitter Voltage	V_{CEX}	400	Vdc
Collector Current – Continuous (Note 1)	I_C	16	Adc
Collector Current – Peak (Note 1)	I_{CM}	30	Adc
Base Current – Continuous	I_B	5	Adc
Total Device Dissipation @ $T_C = 25^\circ\text{C}$ Derate above 25°C	P_D	250 1.43	W W/ $^\circ\text{C}$
Operating and Storage Junction Temperature Range	T_J, T_{stg}	-65 to +200	$^\circ\text{C}$

Stresses exceeding Maximum Ratings may damage the device. Maximum Ratings are stress ratings only. Functional operation above the Recommended Operating Conditions is not implied. Extended exposure to stresses above the Recommended Operating Conditions may affect device reliability.

1. Pulse Test: Pulse Width = 5 ms, Duty Cycle $\leq 10\%$.

THERMAL CHARACTERISTICS

Characteristics	Symbol	Max	Unit
Thermal Resistance, Junction-to-Case	$R_{\theta JC}$	0.70	$^\circ\text{C/W}$

*For additional information on our Pb-Free strategy and soldering details, please download the ON Semiconductor Soldering and Mounting Techniques Reference Manual, SOLDERRM/D.



ON Semiconductor®

<http://onsemi.com>

**16 AMPERES
SILICON POWER TRANSISTORS
200 – 250 VOLTS, 250 WATTS**

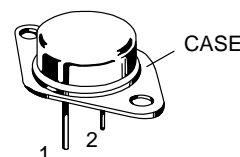
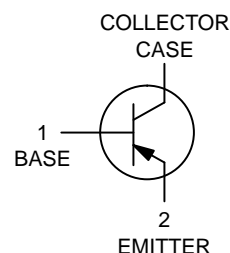

**TO-204 (TO-3)
CASE 1-07
STYLE 1**

MARKING DIAGRAM



MJ1502x = Device Code
x = 3 or 5
G = Pb-Free Package
A = Assembly Location
Y = Year
WW = Work Week
MEX = Country of Origin

ORDERING INFORMATION

Device	Package	Shipping
MJ15023G	TO-204 (Pb-Free)	100 Units / Tray
MJ15025G	TO-204 (Pb-Free)	100 Units / Tray

MJ15023 (PNP), MJ15025 (PNP)

ELECTRICAL CHARACTERISTICS ($T_C = 25^\circ\text{C}$ unless otherwise noted)

Characteristic	Symbol	Min	Max	Unit
OFF CHARACTERISTICS				
Collector-Emitter Sustaining Voltage (Note 2) ($I_C = 100\text{ mAdc}$, $I_B = 0$) MJ15023 MJ15025	$V_{CE(sus)}$	200 250	- -	-
Collector Cutoff Current ($V_{CE} = 200\text{ Vdc}$, $V_{BE(off)} = 1.5\text{ Vdc}$) MJ15023 ($V_{CE} = 250\text{ Vdc}$, $V_{BE(off)} = 1.5\text{ Vdc}$) MJ15025	I_{CEX}	- -	250 250	μAdc
Collector Cutoff Current ($V_{CE} = 150\text{ Vdc}$, $I_B = 0$) MJ15023 ($V_{CE} = 200\text{ Vdc}$, $I_B = 0$) MJ15025	I_{CEO}	- -	500 500	μAdc
Emitter Cutoff Current ($V_{CE} = 5\text{ Vdc}$, $I_B = 0$) Both	I_{EBO}	-	500	μAdc
SECOND BREAKDOWN				
Second Breakdown Collector Current with Base Forward Biased ($V_{CE} = 50\text{ Vdc}$, $t = 0.5\text{ s}$ (non-repetitive)) ($V_{CE} = 80\text{ Vdc}$, $t = 0.5\text{ s}$ (non-repetitive))	$I_{S/b}$	5 2	- -	Adc
ON CHARACTERISTICS				
DC Current Gain ($I_C = 8\text{ Adc}$, $V_{CE} = 4\text{ Vdc}$) ($I_C = 16\text{ Adc}$, $V_{CE} = 4\text{ Vdc}$)	h_{FE}	15 5	60 -	-
Collector-Emitter Saturation Voltage ($I_C = 8\text{ Adc}$, $I_B = 0.8\text{ Adc}$) ($I_C = 16\text{ Adc}$, $I_B = 3.2\text{ Adc}$)	$V_{CE(sat)}$	- -	1.4 4.0	Vdc
Base-Emitter On Voltage ($I_C = 8\text{ Adc}$, $V_{CE} = 4\text{ Vdc}$)	$V_{BE(on)}$	-	2.2	Vdc
DYNAMIC CHARACTERISTICS				
Current-Gain – Bandwidth Product ($I_C = 1\text{ Adc}$, $V_{CE} = 10\text{ Vdc}$, $f_{test} = 1\text{ MHz}$)	f_T	4	-	MHz
Output Capacitance ($V_{CB} = 10\text{ Vdc}$, $I_E = 0$, $f_{test} = 1\text{ MHz}$)	C_{ob}	-	600	pF

2. Pulse Test: Pulse Width = 300 μs , Duty Cycle $\leq 2\%$.

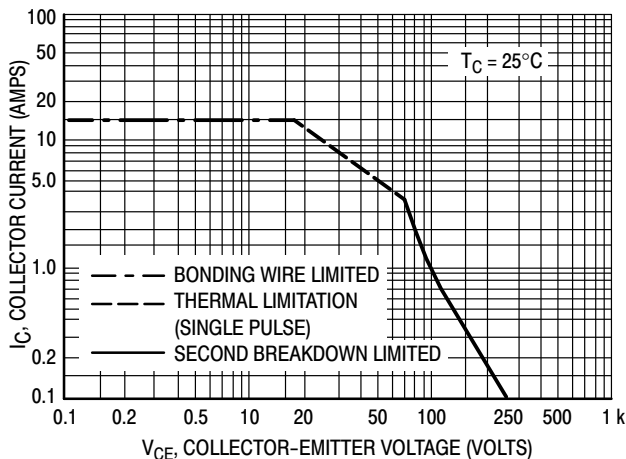

Figure 1. Active-Region Safe Operating Area

There are two limitations on the powerhandling ability of a transistor: average junction temperature and second breakdown. Safe operating area curves indicate $I_C - V_{CE}$ limits of the transistor that must be observed for reliable operation; i.e., the transistor must not be subjected to greater dissipation than the curves indicate.

The data of Figure 1 is based on $T_{J(pk)} = 200^\circ\text{C}$; T_C is variable depending on conditions. At high case temperatures, thermal limitations will reduce the power that can be handled to values less than the limitations imposed by second breakdown.

MJ15023 (PNP), MJ15025 (PNP)

TYPICAL CHARACTERISTICS

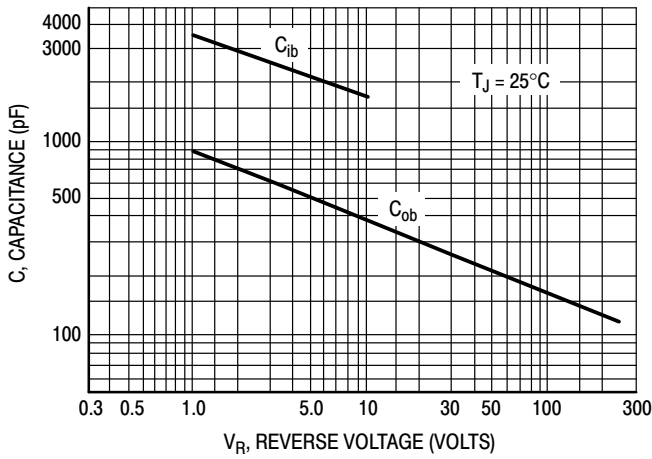

Figure 2. Capacitances

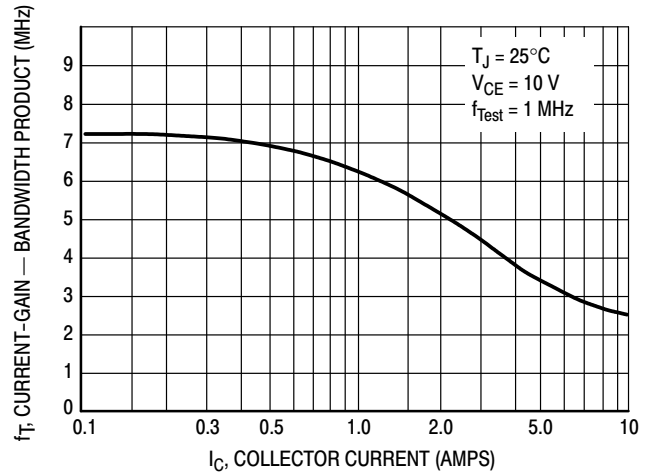

Figure 3. Current-Gain - Bandwidth Product

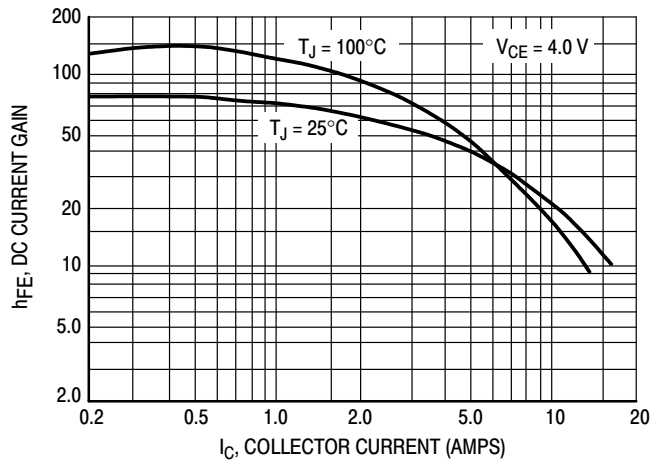

Figure 4. DC Current Gain

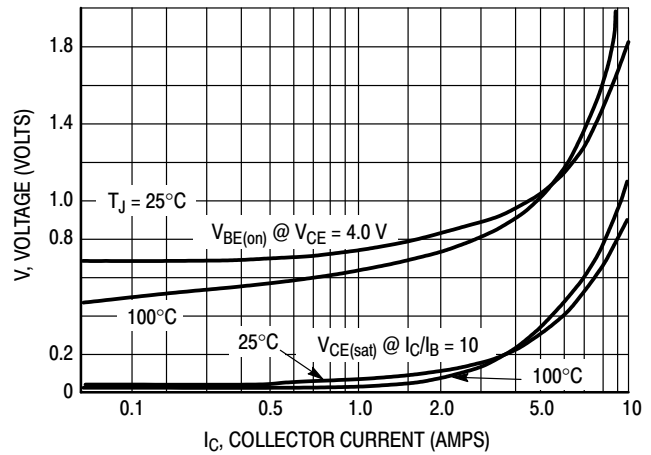
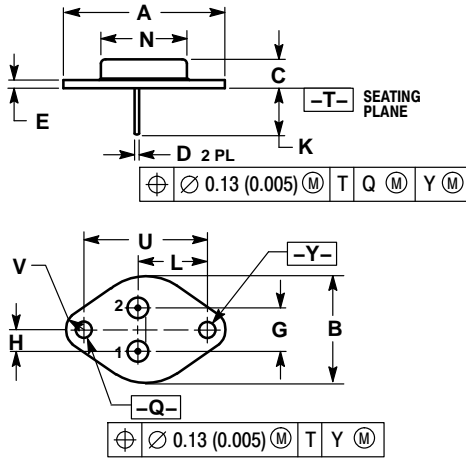

Figure 5. "On" Voltages

MJ15023 (PNP), MJ15025 (PNP)

PACKAGE DIMENSIONS

TO-204 (TO-3) CASE 1-07 ISSUE Z



NOTES:

1. DIMENSIONING AND TOLERANCING PER ANSI Y14.5M, 1982.
2. CONTROLLING DIMENSION: INCH.
3. ALL RULES AND NOTES ASSOCIATED WITH REFERENCED TO-204AA OUTLINE SHALL APPLY.

DIM	INCHES		MILLIMETERS	
	MIN	MAX	MIN	MAX
A	1.550 REF		39.37 REF	
B	---	1.050	---	26.67
C	0.250	0.335	6.35	8.51
D	0.038	0.043	0.97	1.09
E	0.055	0.070	1.40	1.77
G	0.430 BSC		10.92 BSC	
H	0.215 BSC		5.46 BSC	
K	0.440	0.480	11.18	12.19
L	0.665 BSC		16.89 BSC	
N	---	0.830	---	21.08
Q	0.151	0.165	3.84	4.19
U	1.187 BSC		30.15 BSC	
V	0.131	0.188	3.33	4.77

STYLE 1:

1. BASE
 2. EMITTER
- CASE: COLLECTOR

ON Semiconductor and **ON** are registered trademarks of Semiconductor Components Industries, LLC (SCILLC). SCILLC owns the rights to a number of patents, trademarks, copyrights, trade secrets, and other intellectual property. A listing of SCILLC's product/patent coverage may be accessed at www.onsemi.com/site/pdf/Patent-Marking.pdf. SCILLC reserves the right to make changes without further notice to any products herein. SCILLC makes no warranty, representation or guarantee regarding the suitability of its products for any particular purpose, nor does SCILLC assume any liability arising out of the application or use of any product or circuit, and specifically disclaims any and all liability, including without limitation special, consequential or incidental damages. "Typical" parameters which may be provided in SCILLC data sheets and/or specifications can and do vary in different applications and actual performance may vary over time. All operating parameters, including "Typicals" must be validated for each customer application by customer's technical experts. SCILLC does not convey any license under its patent rights nor the rights of others. SCILLC products are not designed, intended, or authorized for use as components in systems intended for surgical implant into the body, or other applications intended to support or sustain life, or for any other application in which the failure of the SCILLC product could create a situation where personal injury or death may occur. Should Buyer purchase or use SCILLC products for any such unintended or unauthorized application, Buyer shall indemnify and hold SCILLC and its officers, employees, subsidiaries, affiliates, and distributors harmless against all claims, costs, damages, and expenses, and reasonable attorney fees arising out of, directly or indirectly, any claim of personal injury or death associated with such unintended or unauthorized use, even if such claim alleges that SCILLC was negligent regarding the design or manufacture of the part. SCILLC is an Equal Opportunity/Affirmative Action Employer. This literature is subject to all applicable copyright laws and is not for resale in any manner.

PUBLICATION ORDERING INFORMATION

LITERATURE FULFILLMENT:

Literature Distribution Center for ON Semiconductor
P.O. Box 5163, Denver, Colorado 80217 USA
Phone: 303-675-2175 or 800-344-3860 Toll Free USA/Canada
Fax: 303-675-2176 or 800-344-3867 Toll Free USA/Canada
Email: orderlit@onsemi.com

N. American Technical Support: 800-282-9855 Toll Free
USA/Canada
Europe, Middle East and Africa Technical Support:
Phone: 421 33 790 2910
Japan Customer Focus Center
Phone: 81-3-5817-1050

ON Semiconductor Website: www.onsemi.com

Order Literature: <http://www.onsemi.com/orderlit>

For additional information, please contact your local Sales Representative