

2SA1695

Silicon PNP Epitaxial Planar Transistor (Complement to type 2SC4468)

Application : Audio and General Purpose

■ Absolute maximum ratings (Ta=25°C)

Symbol	Ratings	Unit
VcBo	-140	V
VcEO	-140	V
VEBO	-6	V
Ic	-10	A
IB	-4	A
Pc	100(Tc=25°C)	W
Tjg	150	°C
Tstg	-55 to +150	°C

■ Electrical Characteristics (Ta=25°C)

Symbol	Conditions	Ratings	Unit
IcBo	VcB=-140V	-10max	μA
IEBO	VEB=-6V	-10max	μA
V(BR)CEO	Ic=-50mA	-140min	V
hFE	VCE=-4V, Ic=-3A	50min*	
VCE(sat)	Ic=-5A, IB=-0.5A	-0.5max	V
fr	VCE=-12V, IE=0.5A	20typ	MHz
COB	VcB=-10V, f=1MHz	400typ	pF

*hFE Rank ○(50 to 100), P(70 to 140), Y(90 to 180)

■ Typical Switching Characteristics (Common Emitter)

Vcc (V)	RL (Ω)	Ic (A)	VBB1 (V)	VBB2 (V)	IB1 (A)	IB2 (A)	ton (μs)	tstg (μs)	tf (μs)
-60	12	-5	-10	5	-0.5	0.5	0.17typ	1.86typ	0.27typ

External Dimensions MT-100(TO3P)

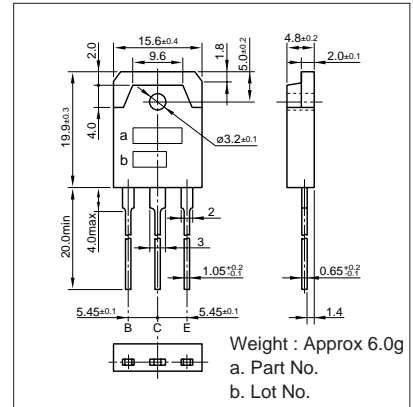

Ic-VCE Characteristics (Typical)

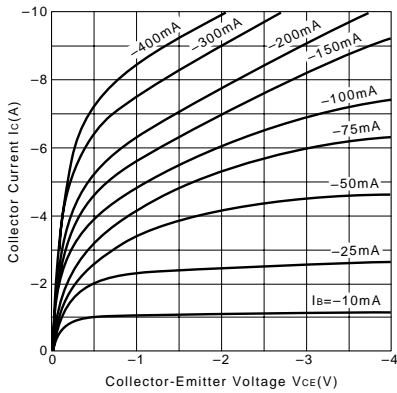

VCE(sat)-IB Characteristics (Typical)

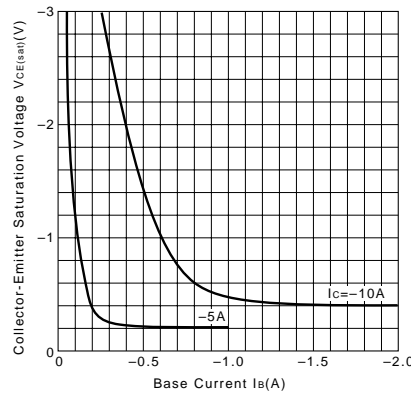

Ic-VBE Temperature Characteristics (Typical)

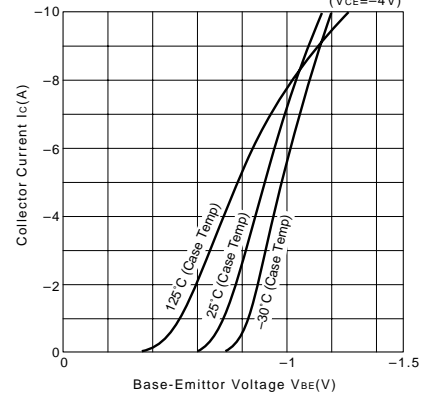

hFE-Ic Characteristics (Typical)

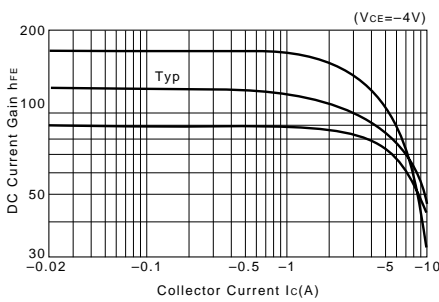

hFE-Ic Temperature Characteristics (Typical)

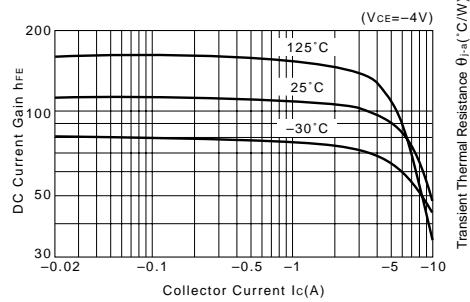

θj-a-t Characteristics

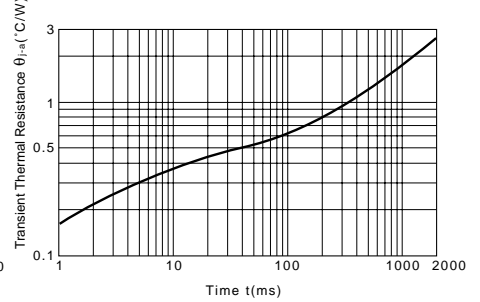

fr-IE Characteristics (Typical)

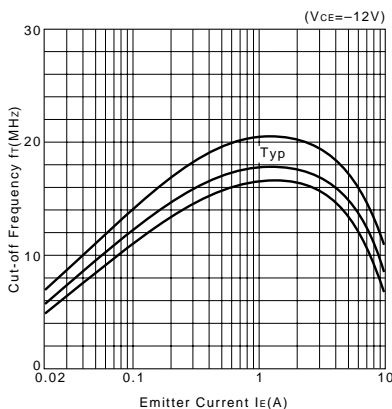

Safe Operating Area (Single Pulse)

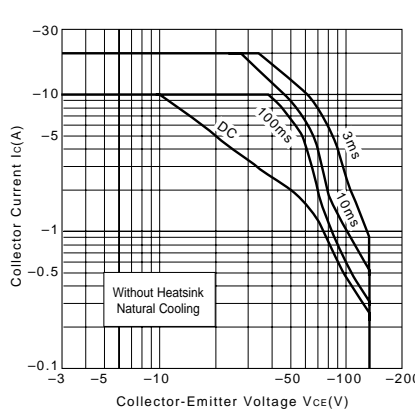

Pc-Ta Derating

