

FAST RECOVERY RECTIFIER DIODE

- VERY HIGH REVERSE VOLTAGE CAPABILITY
- VERY LOW REVERSE RECOVERY TIME
- VERY LOW SWITCHING LOSSES
- LOW NOISE TURN-OFF SWITCHING

SUITABLE APPLICATIONS

- FREE WHEELING DIODE IN CONVERTERS AND MOTOR CONTROL CIRCUITS
- RECTIFIER IN S.M.P.S.

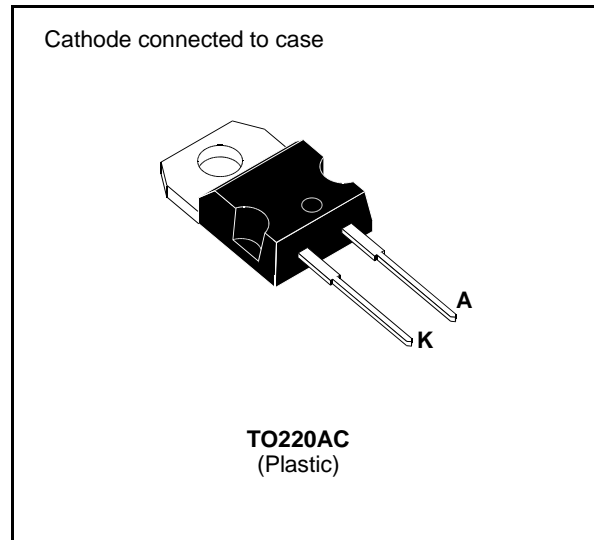

ABSOLUTE MAXIMUM RATINGS

Symbol	Parameter		Value	Unit
V_{RRM}	Repetitive Peak Reverse Voltage		1000	V
V_{RSM}	Non Repetitive Peak Reverse Voltage		1000	V
I_{FRM}	Repetitive Peak Forward Current	$t_p \leq 10\mu s$	150	A
$I_F (RMS)$	RMS Forward Current		25	A
$I_F (AV)$	Average Forward Current	$T_{case} = 100^\circ C$ $\delta = 0.5$	12	A
I_{FSM}	Surge Non Repetitive Forward Current	$t_p = 10ms$ Sinusoidal	75	A
P	Power Dissipation	$T_{case} = 100^\circ C$	25	W
T_{stg} T_j	Storage and Junction Temperature Range		- 40 to + 150 - 40 to + 150	$^\circ C$

THERMAL RESISTANCE

Symbol	Test Conditions	Value	Unit
$R_{th(j-c)}$	Junction-case	2	$^\circ C/W$

ELECTRICAL CHARACTERISTICS

STATIC CHARACTERISTICS

Symbol	Test Conditions		Min.	Typ.	Max.	Unit
I_R	$T_j = 25^\circ\text{C}$	$V_R = V_{RRM}$			50	μA
	$T_j = 100^\circ\text{C}$				2.5	mA
V_F	$T_j = 25^\circ\text{C}$	$I_F = 12\text{A}$			1.9	V
	$T_j = 100^\circ\text{C}$				1.8	

RECOVERY CHARACTERISTICS

Symbol	Test Conditions			Min.	Typ.	Max.	Unit
t_{rr}	$T_j = 25^\circ\text{C}$	$I_F = 1\text{A}$	$di_F/dt = -15\text{A}/\mu\text{s}$	$V_R = 30\text{V}$		155	ns
		$I_F = 0.5\text{A}$	$I_R = 1\text{A}$	$I_{rr} = 0.25\text{A}$		65	

TURN-OFF SWITCHING CHARACTERISTICS (Without Series Inductance)

Symbol	Test Conditions		Min.	Typ.	Max.	Unit
t_{IRM}	$di_F/dt = -50\text{A}/\mu\text{s}$	$V_{CC} = 200\text{V}$ $I_F = 12\text{A}$ $L_p \leq 0.05\mu\text{H}$ $T_j = 100^\circ\text{C}$ See figure 11			200	ns
	$di_F/dt = -100\text{A}/\mu\text{s}$			120		
I_{RM}	$di_F/dt = -50\text{A}/\mu\text{s}$				7.8	A
	$di_F/dt = -100\text{A}/\mu\text{s}$			9		

TURN-OFF OVERVOLTAGE COEFFICIENT (With Series Inductance)

Symbol	Test Conditions			Min.	Typ.	Max.	Unit
$C = \frac{V_{RP}}{V_{CC}}$	$T_j = 100^\circ\text{C}$	$V_{CC} = 200\text{V}$	$I_F = I_{F(AV)}$			4.5	
	$di_F/dt = -12\text{A}/\mu\text{s}$	$L_p = 12\mu\text{H}$	See figure 12				

To evaluate the conduction losses use the following equations:

$$V_F = 1.47 + 0.026 I_F \quad P = 1.47 \times I_{F(AV)} + 0.026 I_{F(RMS)}^2$$

Figure 1. Low frequency power losses versus average current

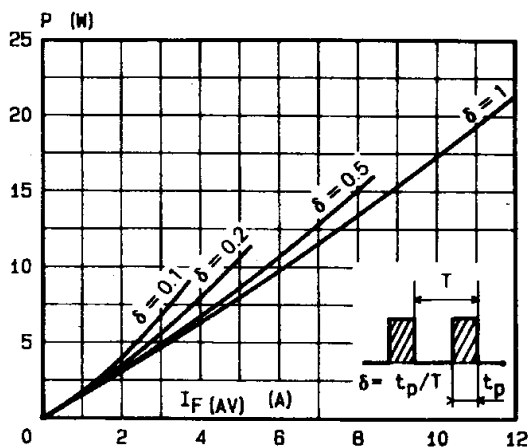

Figure 2. Peak current versus form factor

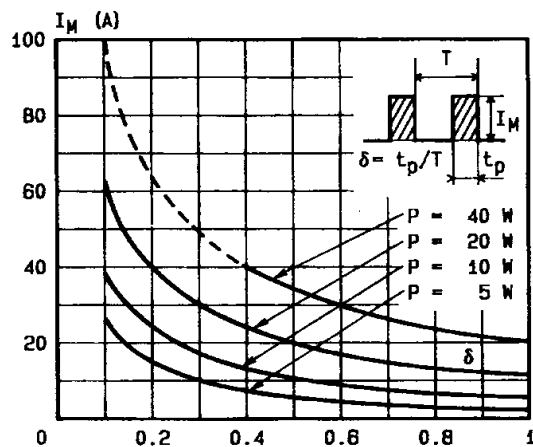

Figure 3. Non repetitive peak surge current versus overload duration

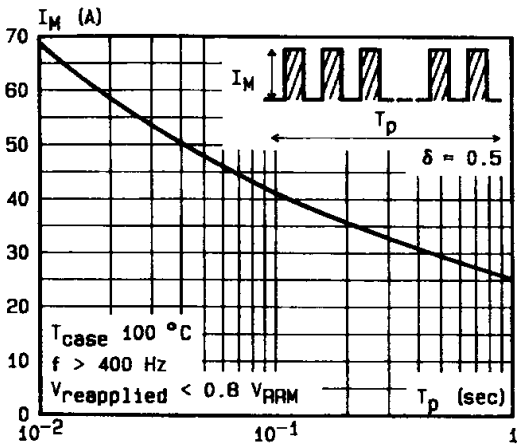

Figure 4. Thermal impedance versus pulse width

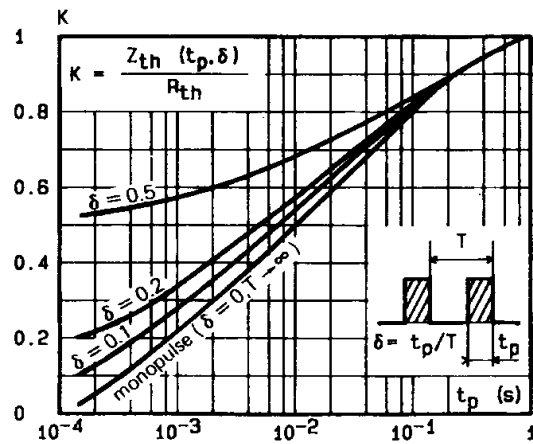

Figure 5. Voltage drop versus forward current

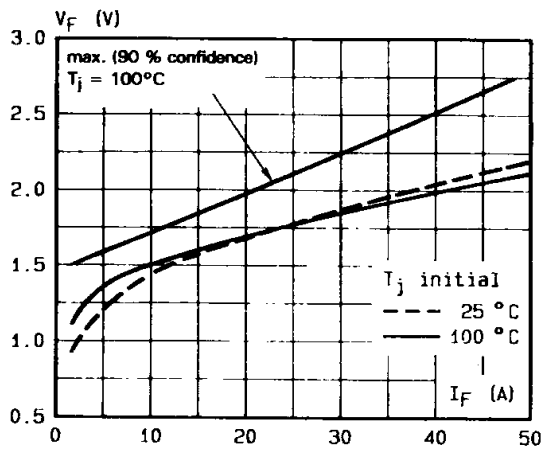

Figure 6. Recovery charge versus di_F/dt

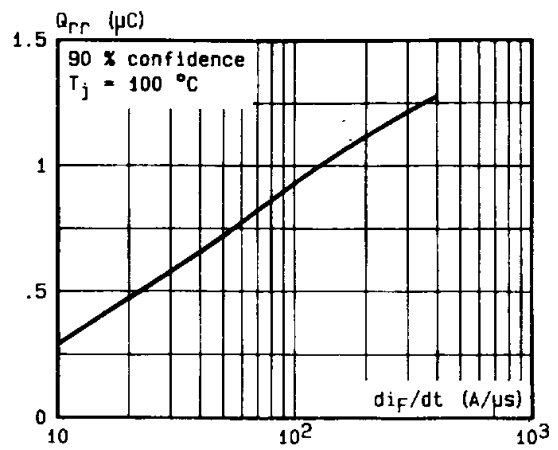

Figure 7. Recovery time versus di_F/dt

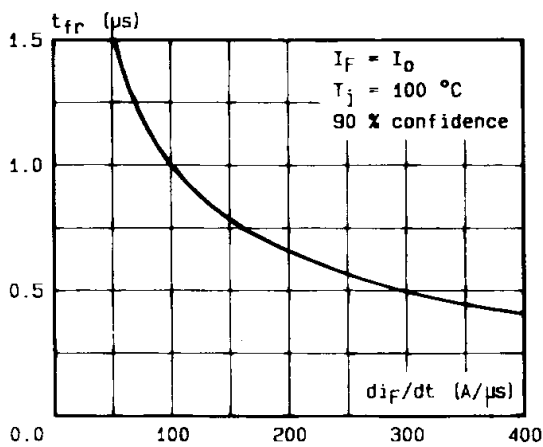

Figure 8. Peak reverse current versus di_F/dt

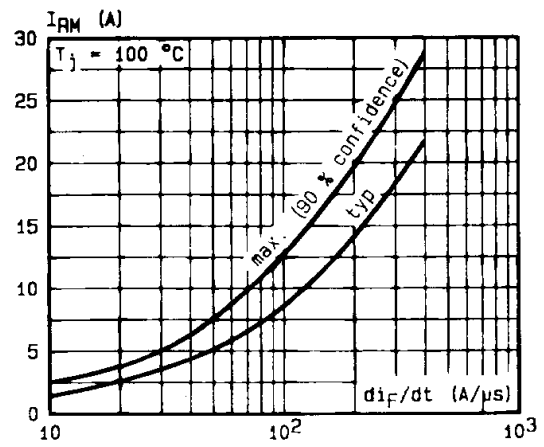

Figure 9. Peak forward voltage versus di_F/dt

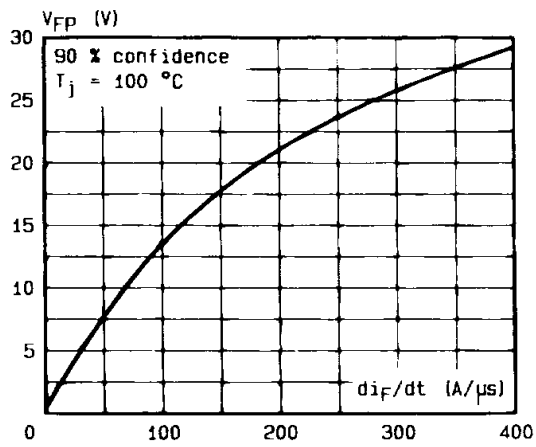

Figure 10. Dynamic parameters versus junction temperature.

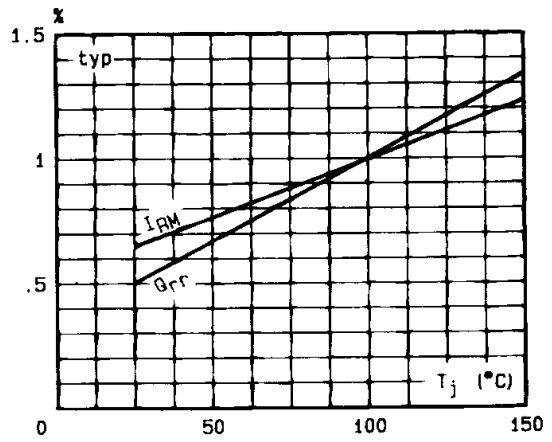

Figure 11. Turn-off switching characteristics (without series inductance).

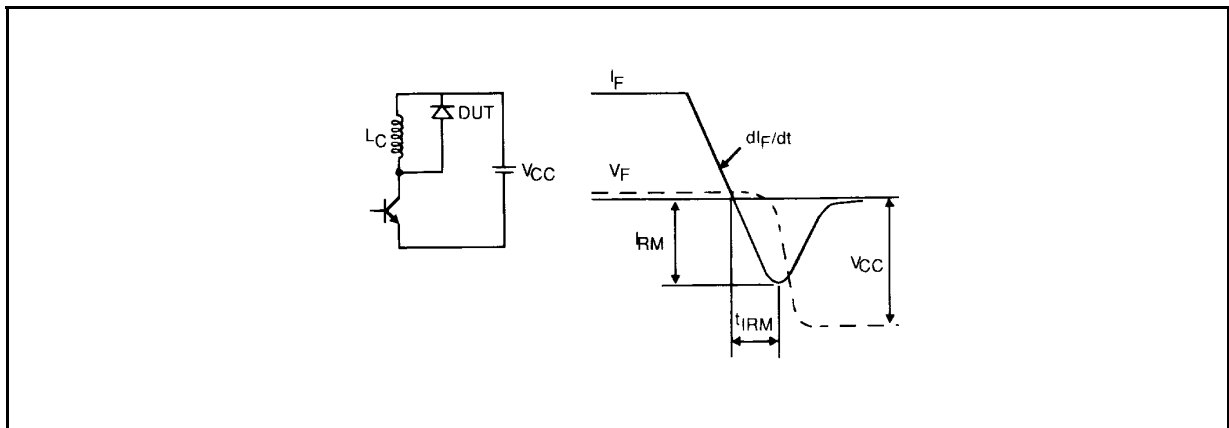
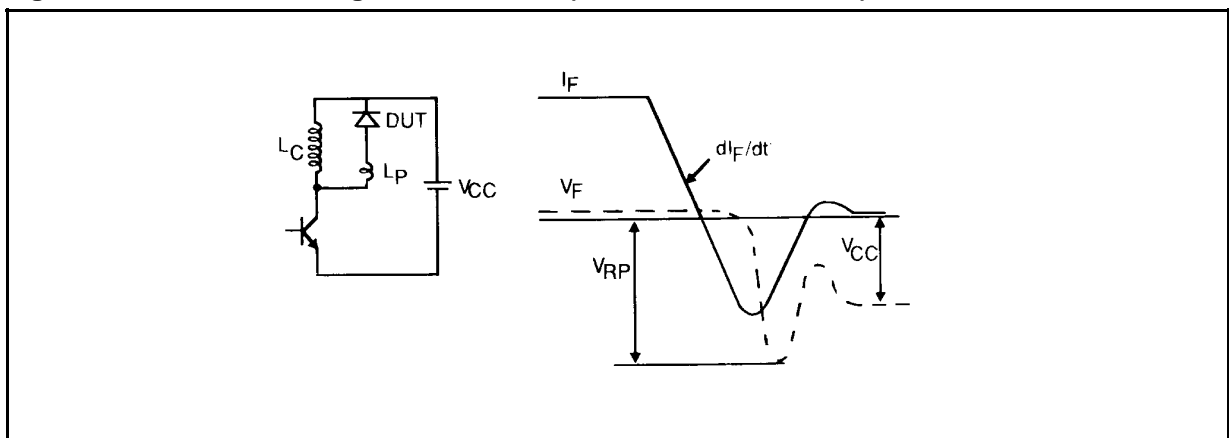
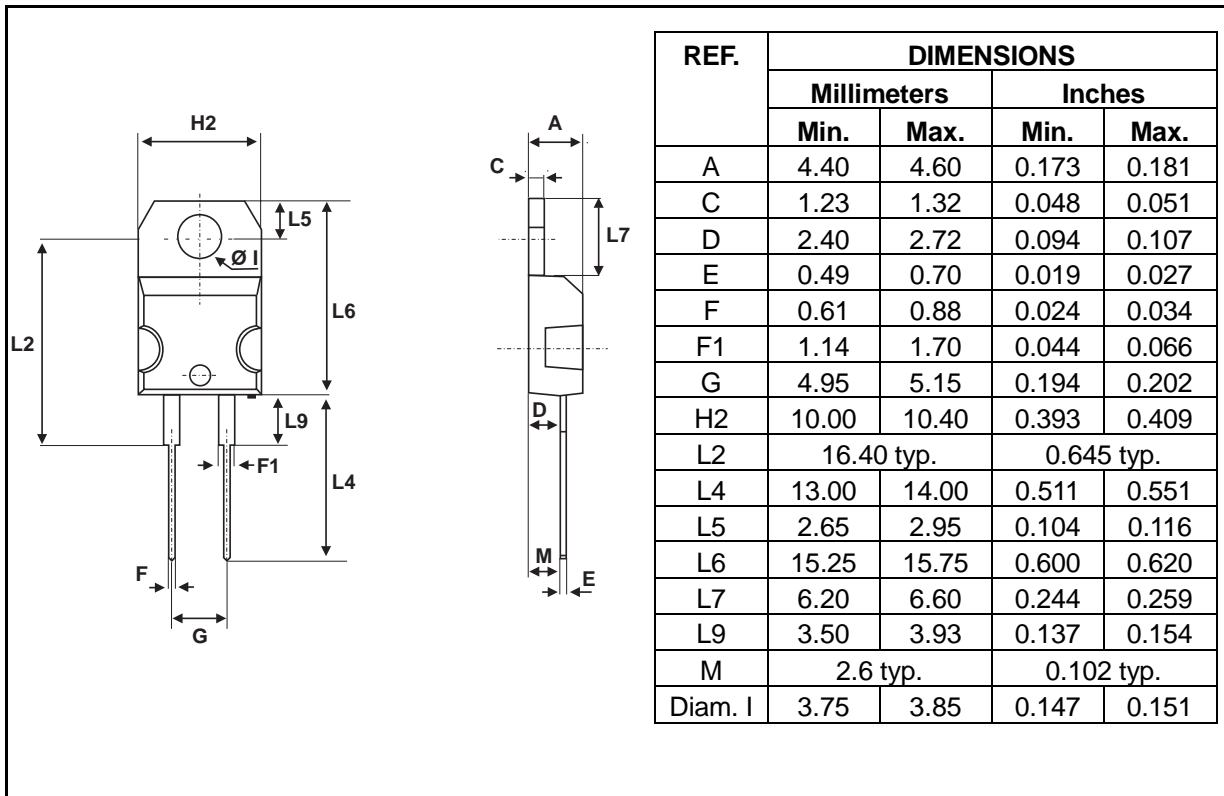

Figure 12. Turn-off switching characteristics (with series inductance)



PACKAGE MECHANICAL DATA :
TO220AC Plastic



- **Marking:** type number
- **Cooling method:** by conduction (method C)
- **Weight :** 1.86g
- **Recommended torque value :** 80cm. N
- **Maximum torque value :** 100cm. N

Information furnished is believed to be accurate and reliable. However, STMicroelectronics assumes no responsibility for the consequences of use of such information nor for any infringement of patents or other rights of third parties which may result from its use. No license is granted by implication or otherwise under any patent or patent rights of STMicroelectronics. Specifications mentioned in this publication are subject to change without notice. This publication supersedes and replaces all information previously supplied. STMicroelectronics products are not authorized for use as critical components in life support devices or systems without express written approval of STMicroelectronics.

The ST logo is a registered trademark of STMicroelectronics
© 1999 STMicroelectronics - Printed in Italy - All rights reserved.

STMicroelectronics GROUP OF COMPANIES
Australia - Brazil - China - Finland - France - Germany - Hong Kong - India - Italy - Japan - Malaysia
Malta - Morocco - Singapore - Spain - Sweden - Switzerland - United Kingdom - U.S.A.

<http://www.st.com>



This datasheet has been download from:

www.datasheetcatalog.com

Datasheets for electronics components.