



# SEMICONDUCTOR GENERAL CATALOG

## Transistors

Bipolar Small-Signal Transistors  
    Junction FETs  
Combination Products of Different Type Devices  
    MOSFETs  
    Bipolar Power Transistors  
Radio-Frequency Bipolar Small-Signal Transistors  
    Radio-Frequency Small-Signal FETs  
    Radio-Frequency Power MOSFETs  
    IGBTs  
    Phototransistors

# Bipolar Small-Signal Transistors

## General-Purpose Transistors (Single)

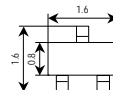
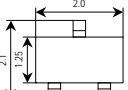
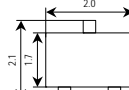
Classification	V <sub>CEO</sub> (V) Max	I <sub>C</sub> (mA) Max	(Surface-Mount Type)										
			CST3		VESM		SSM		USM		UFM		
													
(mm)		(mm)		(mm)		(mm)		(mm)					
			NPN	PNP	NPN	PNP	NPN	PNP	NPN	PNP	NPN	PNP	
General-purpose	50	100	2SC6026CT	2SA2154CT									
		150			2SC6026MFV	2SA2154MFV	2SC4738	2SA1832	<b>TTC4116*</b>	<b>TTA1586*</b>			
	30	500							<b>2SC4118</b>	<b>2SA1588</b>			
	50	500											
Low noise	120	100							<b>2SC4117</b>	<b>2SA1587</b>			
High current	12	400			2SC5376FV	2SA1955FV	2SC5376	2SA1955					
	12	500							2SC5233	2SA1954			
	15	800											
	25	800											
	30	800											
	10	2000											
	20	2000											
	20	1500											
	20	2500										2SC6133*	2SA2214*
	30	3000										2SA2215*	
	50	1000										2SC6134*	
50	1700										2SC6135*		
50	2500											2SA2195*	
Strobe	10	5000 (3000)										2SC6100*	
High breakdown voltage	80	300											
High h <sub>FE</sub>	50	150											
Muting	20	300							2SC4213				
High-speed switching	15	200											
High-voltage switching	200	50											
High breakdown voltage	250	50											
	300	100											
Darlington	40	300											

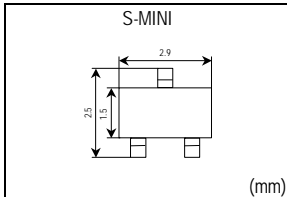

- For the PNP transistors, the minus sign (-) indicating a negative voltage is omitted.
- The products shown in bold are also manufactured in offshore fabs.
- Contact the Toshiba sales representative for information about RoHS compliance before you purchase any com



NPN	PNP
<b>2SC2712</b>	<b>2SA1162</b>
<b>2SC2859</b>	<b>2SA1182</b>
<b>2SC3325</b>	<b>2SA1313</b>
<b>2SC2713</b>	<b>2SA1163</b>
2SC3324	2SA1312
2SC5232	2SA1953
	<b>2SA1362</b>
<b>2SC3265</b>	<b>2SA1298</b>
	2SA1621
	2SA1620
<b>2SC3326</b>	
2SC3138	
2SC4497	2SA1721

\*: New product

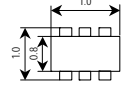
# General-Purpose Transistors (Dual)

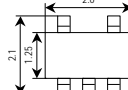
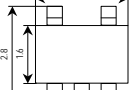
Classification	V <sub>CE0</sub> (V) Max	I <sub>c</sub> (mA) Max	Dual Type									
			CST6  (mm)	fs6  (mm)			ESV  (mm)	USV  (mm)		SMV  (mm)		
			NPN + PNP	NPN	PNP	NPN + PNP	PNP + NPN	NPN	PNP	NPN	PNP	PNP + NPN
General-purpose	50	150 (100)	(HN2B26CT) (▲18) **	(HN1C26FS) (▲10) (HN2C26FS) (▲12)	(HN1A26FS) (▲7) (HN2A26FS) (▲11)	(HN1B26FS) (▲9)	HN4B01JE (▲6)	2SC4944 (▲2)	2SA1873 (▲1) HN4A56JU (▲4)	2SC4207 (▲2)	2SA1618 (▲1)	
	30	500										HN4B04J (▲3) *
	50	500										
Low noise	120	100								HN4C06J (▲2) HN4C51J (▲5)	HN4A06J (▲1) HN4A51J (▲4)	HN4B06J (▲3)
High current	12	400						HN4C05JU (▲2)				
	12	500										
	15	800										
	30	800										
	10	2000										
20	2000											
Strobe	10	5000										
High breakdown voltage	80	300										
High h <sub>FE</sub>	50	150										
Muting	20	300										
High-speed switching	15	200										
High-voltage switching	200	50										
High breakdown voltage	250	50										
	300	100										
Darlington	40	300										

- For the PNP transistors, the minus sign (-) indicating a negative voltage is omitted.
- The ratings enclosed in parenthesis are for those devices whose part numbers are enclosed in parentheses.
- The products shown in bold are also manufactured in offshore fabs.
- Contact the Toshiba sales representative for information about RoHS compliance before you purchase any components.

## ◆Internal Connections

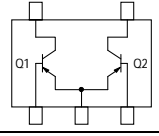
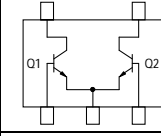
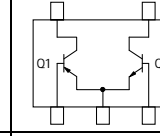
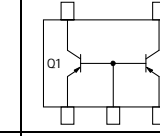
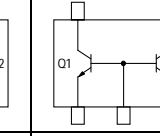
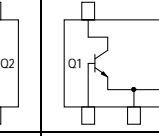
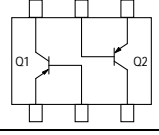
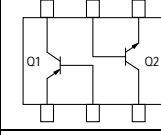
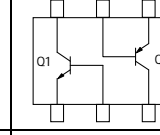
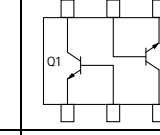
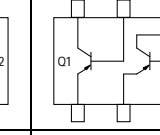
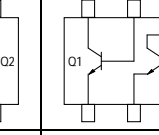
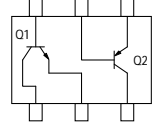
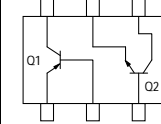
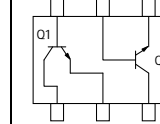
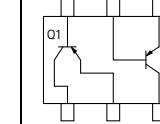
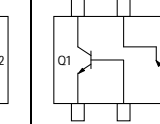
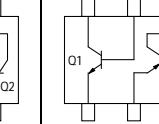
Number of Pins	▲1	▲2	▲3	▲4	▲5	▲6
5						
6	▲7	▲8	▲9	▲10	▲11	▲12
						
6	▲13	▲14	▲15	▲16	▲17	▲18
						

◆The internal connection diagrams only show the general configurations of the circuits.

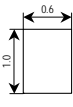
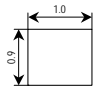
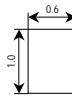
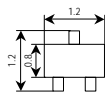
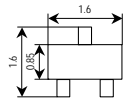

### Bias Resistor Built-in Transistors (Single, General-Purpose)

Ratings	V <sub>CE0</sub> (V)	20					50					
	I <sub>c</sub> (mA)	50					100					
Internal Resistors (kΩ)	CST3		CST6				CST3		VESM		ESM	
												
R1	R2	NPN	PNP	NPN	PNP	NPN + PNP	NPN	PNP	NPN	PNP	NPN	PNP
4.7	4.7	RN1101CT	RN2101CT	RN1961CT	RN2961CT		RN1101ACT	RN2101ACT	RN1101MFV	RN2101MFV	RN1101F	RN2101F
10	10	RN1102CT	RN2102CT	RN1962CT	RN2962CT		RN1102ACT	RN2102ACT	RN1102MFV	RN2102MFV	RN1102F	RN2102F
22	22	RN1103CT	RN2103CT	RN1963CT	RN2963CT		RN1103ACT	RN2103ACT	RN1103MFV	RN2103MFV	RN1103F	RN2103F
47	47	RN1104CT	RN2104CT	RN1964CT	RN2964CT		RN1104ACT	RN2104ACT	RN1104MFV	RN2104MFV	RN1104F	RN2104F
2.2	47	RN1105CT	RN2105CT	RN1965CT	RN2965CT		RN1105ACT	RN2105ACT	RN1105MFV	RN2105MFV	RN1105F	RN2105F
4.7	47	RN1106CT	RN2106CT	RN1966CT	RN2966CT	RN49P2ACT	RN1106ACT	RN2106ACT	RN1106MFV	RN2106MFV	RN1106F	RN2106F
10	47	RN1107CT	RN2107CT	RN1967CT	RN2967CT		RN1107ACT	RN2107ACT	RN1107MFV	RN2107MFV	RN1107F	RN2107F
22	47	RN1108CT	RN2108CT	RN1968CT	RN2968CT		RN1108ACT	RN2108ACT	RN1108MFV	RN2108MFV	RN1108F	RN2108F
47	22	RN1109CT	RN2109CT	RN1969CT	RN2969CT		RN1109ACT	RN2109ACT	RN1109MFV	RN2109MFV	RN1109F	RN2109F
4.7	∞	RN1110CT	RN2110CT	RN1970CT	RN2970CT		RN1110ACT	RN2110ACT	RN1110MFV	RN2110MFV	RN1110F	RN2110F
10	∞	RN1111CT	RN2111CT	RN1971CT	RN2971CT		RN1111ACT	RN2111ACT	RN1111MFV	RN2111MFV	RN1111F	RN2111F
22	∞	RN1112CT	RN2112CT	RN1972CT	RN2972CT		RN1112ACT	RN2112ACT	RN1112MFV	RN2112MFV	RN1112F	RN2112F
47	∞	RN1113CT	RN2113CT	RN1973CT	RN2973CT		RN1113ACT	RN2113ACT	RN1113MFV	RN2113MFV	RN1113F	RN2113F
1	10								RN1114MFV	RN2114MFV	RN1114F	RN2114F
2.2	10								RN1115MFV	RN2115MFV	RN1115F	RN2115F
4.7	10								RN1116MFV	RN2116MFV	RN1116F	RN2116F
10	4.7								RN1117MFV	RN2117MFV	RN1117F	RN2117F
47	10								RN1118MFV	RN2118MFV	RN1118F	RN2118F
1	—								RN1119MFV	RN2119MFV		
100	100								RN1130MFV	RN2130MFV	RN1130F	RN2130F
100	∞								RN1131MFV	RN2131MFV	RN1131F	RN2131F
200	∞								RN1132MFV	RN2132MFV	RN1132F	RN2132F

- For the PNP transistors, the minus sign (-) indicating a negative voltage is omitted.
- The products shown in bold are also manufactured in offshore fabs.
- Contact the Toshiba sales representative for information about RoHS compliance before you purchase any components.

### (Single, High-Current/Muting Switch)

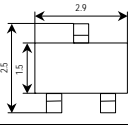
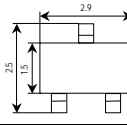
Ratings	V <sub>CE0</sub> (V)	High Current		Muting
	I <sub>c</sub> (mA)	800		300
Internal Resistors (kΩ)	S-MINI		S-MINI	
				
R1	R2	NPN	PNP	NPN
1	1	RN1421	RN2421	
2.2	2.2	RN1422	RN2422	
4.7	4.7	RN1423	RN2423	
10	10	RN1424	RN2424	
0.47	10	RN1425	RN2425	
1	10	RN1426	RN2426	
2.2	10	RN1427	RN2427	
5.6	∞			RN1441
10	∞			RN1442
22	∞			RN1443
2.2	∞			RN1444

- For the PNP transistors, the minus sign (-) indicating a negative voltage is omitted.
- Contact the Toshiba sales representative for information about RoHS compliance before you purchase any components.

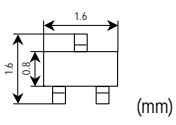
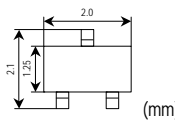
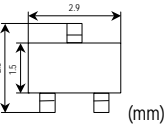
50					
100					
SSM		USM		S-MINI	
 (mm)		 (mm)		 (mm)	
NPN	PNP	NPN	PNP	NPN	PNP
RN1101	RN2101	<b>RN1301</b>	<b>RN2301</b>	<b>RN1401</b>	<b>RN2401</b>
RN1102	RN2102	<b>RN1302</b>	<b>RN2302</b>	<b>RN1402</b>	<b>RN2402</b>
RN1103	RN2103	<b>RN1303</b>	<b>RN2303</b>	<b>RN1403</b>	<b>RN2403</b>
RN1104	RN2104	<b>RN1304</b>	<b>RN2304</b>	<b>RN1404</b>	<b>RN2404</b>
RN1105	RN2105	<b>RN1305</b>	<b>RN2305</b>	<b>RN1405</b>	<b>RN2405</b>
RN1106	RN2106	<b>RN1306</b>	<b>RN2306</b>	<b>RN1406</b>	<b>RN2406</b>
RN1107	RN2107	<b>RN1307</b>	<b>RN2307</b>	<b>RN1407</b>	<b>RN2407</b>
RN1108	RN2108	<b>RN1308</b>	<b>RN2308</b>	<b>RN1408</b>	<b>RN2408</b>
RN1109	RN2109	<b>RN1309</b>	<b>RN2309</b>	<b>RN1409</b>	<b>RN2409</b>
RN1110	RN2110	<b>RN1310</b>	<b>RN2310</b>	<b>RN1410</b>	<b>RN2410</b>
RN1111	RN2111	<b>RN1311</b>	<b>RN2311</b>	<b>RN1411</b>	<b>RN2411</b>
RN1112	RN2112	RN1312	RN2312	RN1412	RN2412
RN1113	RN2113	RN1313	RN2313	RN1413	RN2413
RN1114	RN2114	RN1314	RN2314	RN1414	RN2414
RN1115	RN2115	RN1315	RN2315	RN1415	RN2415
RN1116	RN2116	RN1316	RN2316	RN1416	RN2416
RN1117	RN2117	RN1317	RN2317	RN1417	RN2417
RN1118	RN2118	RN1318	RN2318	RN1418	RN2418

### Bias Resistor Built-in Transistors (Dual, General-Purpose (5 Pin))

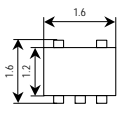
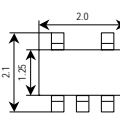
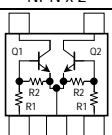
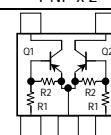
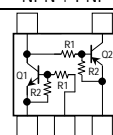
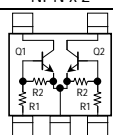
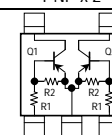
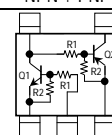
Classification	Absolute Maximum Ratings		Internal Resistors				ESV			USV			
	V <sub>CEO</sub> (V)	I <sub>c</sub> (mA)	Q1		Q2								
			(kΩ)		(kΩ)		(mm)			(mm)			
			R1	R2	R1	R2	NPN x 2 	PNP x 2 	NPN + PNP 	NPN x 2 	PNP x 2 	NPN + PNP 	
						Common emitter	Common emitter	Collector-base connection	Common emitter	Common emitter	Collector-base connection		
General-purpose	50	100	4.7	4.7	4.7	4.7	RN1701JE	RN2701JE		RN1701	RN2701		
			10	10	10	10	RN1702JE	RN2702JE	RN47A3JE	RN1702	RN2702	RN47A3	
			22	22	22	22	RN1703JE	RN2703JE	RN47A2JE	RN1703	RN2703	RN47A2	
			47	47	47	47	RN1704JE	RN2704JE		RN1704	RN2704		
			2.2	47	2.2	47	RN1705JE	RN2705JE		RN1705	RN2705		
			4.7	47	4.7	47	RN1706JE	RN2706JE		RN1706	RN2706		
			10	47	10	47	RN1707JE	RN2707JE		RN1707	RN2707		
			22	47	22	47	RN1708JE	RN2708JE		RN1708	RN2708		
			47	22	47	22	RN1709JE	RN2709JE		RN1709	RN2709		
			4.7	—	4.7	—	RN1710JE	RN2710JE	RN47A1JE	RN1710	RN2710	RN47A1	
			10	—	10	—	RN1711JE	RN2711JE		RN1711	RN2711		
			22	—	22	—		RN2712JE					
			47	—	47	—		RN2713JE					
			1	10	1	10						RN2714	
			2.2	10	2.2	10							
			4.7	10	4.7	10							
			10	4.7	10	4.7							
			47	10	47	10							
			47	47	10	47			RN47A4JE				RN47A4
			47	47	4.7	10			RN47A5JE				RN47A5
			100	100	100	100							RN47A6
			10	10	47	10							RN47A7
	Q1: 50	Q1: 100						RN47A7JE					
	Q2: 12	Q2: 100 (Lowsat)	10	10	4.7	10							
	Q1: 50	Q1: 100											
	Q2: 30	Q2: 100 (High hFE)	10	10	10	47			RN47A8JE				
Muting	20	300	2.2	—	2.2	—							

- For the PNP transistors, the minus sign (-) indicating a negative voltage is omitted.
- The products shown in bold are also manufactured in offshore fabs.
- Contact the Toshiba sales representative for information about RoHS compliance before you purchase any components.





(Dual, General-Purpose (6 Pin))

Classification		fs6																				
		Absolute Maximum Ratings		Internal Resistors				NPN	PNP	PNP + NPN	Absolute Maximum Ratings		Internal Resistors		NPN x 2	PNP x 2						
		V <sub>CEO</sub> (V)	I <sub>C</sub> (mA)	Q1 (kΩ)		Q2 (kΩ)					V <sub>CEO</sub> (V)	I <sub>C</sub> (mA)	Q1 (kΩ)		Q2 (kΩ)							
General-purpose	50	80	4.7	4.7	4.7	4.7	RN1901AFS	RN2901AFS	RN4981AFS	20	50	4.7	4.7	4.7	4.7	RN1901FS	RN2901FS					
			10	10	10	10	RN1902AFS	RN2902AFS	RN4982AFS			10	10	10	10	RN1902FS	RN2902FS					
			22	22	22	22	RN1903AFS	RN2903AFS	RN4983AFS			22	22	22	22	RN1903FS	RN2903FS					
			47	47	47	47	RN1904AFS	RN2904AFS	RN4984AFS			47	47	47	47	RN1904FS	RN2904FS					
			2.2	47	2.2	47	RN1905AFS	RN2905AFS	RN4985AFS			2.2	47	2.2	47	RN1905FS	RN2905FS					
			4.7	47	4.7	47	RN1906AFS	RN2906AFS	RN4986AFS			4.7	47	4.7	47	RN1906FS	RN2906FS					
			10	47	10	47	RN1907AFS	RN2907AFS	RN4987AFS			10	47	10	47	RN1907FS	RN2907FS					
			22	47	22	47	RN1908AFS	RN2908AFS	RN4988AFS			22	47	22	47	RN1908FS	RN2908FS					
			47	22	47	22	RN1909AFS	RN2909AFS	RN4989AFS			47	22	47	22	RN1909FS	RN2909FS					
			4.7	—	4.7	—	RN1910AFS	RN2910AFS	RN4990AFS			4.7	—	4.7	—	RN1910FS	RN2910FS					
			10	—	10	—	RN1911AFS	RN2911AFS	RN4991AFS			10	—	10	—	RN1911FS	RN2911FS					
			22	—	22	—	RN1912AFS	RN2912AFS	RN4992AFS			22	—	22	—	RN1912FS	RN2912FS					
			47	—	47	—	RN1913AFS	RN2913AFS	RN4993AFS			47	—	47	—	RN1913FS	RN2913FS					
			General-purpose (H $\beta$ )	40 (-30)	100	4.7	—	4.7	—						40 (-30)	100	4.7	—	4.7	—		
						10	—	10	—							100	10	—	10	—		
			22	—	22	—					100	22	—	22	—							
Power SW	50 (-12)	100 (-500)	10	47	2.0	10				50 (-12)	100 (-500)	10	47	2.0	10							

- For the PNP transistors, the minus sign (-) indicating a negative voltage is omitted.
- Contact the Toshiba sales representative for information about RoHS compliance before you purchase any components.

(mm)

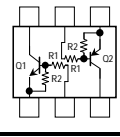
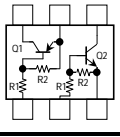
NPN + PNP	Absolute Maximum Ratings		Internal Resistors				NPN + PNP		
	V <sub>CEO</sub> (V)	I <sub>C</sub> (mA)	Q1		Q2				
			R1 (kΩ)	R2 (kΩ)	R1 (kΩ)	R2 (kΩ)			
									
RN4981FS	50	50	4.7	4.7	4.7	4.7			
RN4982FS			10	10	10	10			
RN4983FS			22	22	22	22			
RN4984FS			47	47	47	47	RN49J2AFS		
RN4985FS			2.2	47	2.2	47			
RN4986FS			4.7	47	4.7	47			
RN4987FS			10	47	10	47			
RN4988FS			22	47	22	47			
RN4989FS			47	22	47	22			
RN4990FS			4.7	—	4.7	—			
RN4991FS			10	—	10	—			
RN4992FS			22	—	22	—			
RN4993FS			47	—	47	—			
					1	10	1	10	
					2.2	10	2.2	10	
					4.7	10	4.7	10	
					10	4.7	10	4.7	
					47	10	47	10	
					2.2	47	22	47	
					2.2	47	47	47	
			22	22	10	10			
RN49A6FS			47	47	4.7	47			
	40 (-30)	100	4.7	—	4.7	—			
			10	—	10	—			
			22	—	22	—			
	50 (-12)	100 (-500)	10	47	2.0	10			

The internal connection diagrams only show the general configurations of the circuits.

(Dual, General-Purpose (6 Pin) ) (Continued)

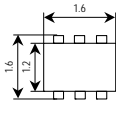
Classification	Absolute Maximum Ratings		Internal Resistors				ES6						
	V <sub>CEO</sub> (V)	I <sub>c</sub> (mA)	Q1		Q2		 (mm)						
			(kΩ)		(kΩ)								
			R1	R2	R1	R2	NPN x 2	PNP x 2	NPN x 2	PNP x 2	PNP + NPN	NPN + PNP	NPN + PNP
General-purpose	50	100	4.7	4.7	4.7	4.7	RN1901FE	RN2901FE	RN1961FE	RN2961FE	RN4901FE	RN4981FE	
			10	10	10	10	RN1902FE	RN2902FE	RN1962FE	RN2962FE	RN4902FE	RN4982FE	RN4962FE
			22	22	22	22	RN1903FE	RN2903FE	RN1963FE	RN2963FE	RN4903FE	RN4983FE	
			47	47	47	47	RN1904FE	RN2904FE	RN1964FE	RN2964FE	RN4904FE	RN4984FE	
			2.2	47	2.2	47	RN1905FE	RN2905FE	RN1965FE	RN2965FE	RN4905FE	RN4985FE	
			4.7	47	4.7	47	RN1906FE	RN2906FE	RN1966FE	RN2966FE	RN4906FE	RN4986FE	
			10	47	10	47	RN1907FE	RN2907FE	RN1967FE	RN2967FE	RN4907FE	RN4987FE	
			22	47	22	47	RN1908FE	RN2908FE	RN1968FE	RN2968FE	RN4908FE	RN4988FE	
			47	22	47	22	RN1909FE	RN2909FE	RN1969FE	RN2969FE	RN4909FE	RN4989FE	
			4.7	—	4.7	—	RN1910FE	RN2910FE	RN1970FE	RN2970FE	RN4910FE	RN4990FE	
			10	—	10	—	RN1911FE	RN2911FE	RN1971FE	RN2971FE	RN4911FE	RN4991FE	
			22	—	22	—							
			47	—	47	—							
			1	10	1	10							
			2.2	10	2.2	10							
			4.7	10	4.7	10							
			10	4.7	10	4.7							
			47	10	47	10							
			2.2	47	22	47					RN49A1FE		
			2.2	47	47	47							
22	22	10	10										
10	10	10	—										

- For the PNP transistors, the minus sign (–) indicating a negative voltage is omitted.
- Contact the Toshiba sales representative for information about RoHS compliance before you purchase any components.

The internal connection diagrams only show the general configurations of the circuits.

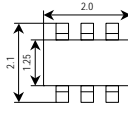
Classification	Absolute Maximum Ratings		Internal Resistors				US6					
	V <sub>CEO</sub> (V)	I <sub>c</sub> (mA)	Q1		Q2		 (mm)					
			(kΩ)		(kΩ)							
			R1	R2	R1	R2	NPN x 2	PNP x 2	NPN x 2	PNP x 2	PNP + NPN	NPN + PNP
General-purpose	50	100	4.7	4.7	4.7	4.7	<b>RN1901</b>	<b>RN2901</b>	RN1961	RN2961	<b>RN4901</b>	<b>RN4981</b>
			10	10	10	10	<b>RN1902</b>	<b>RN2902</b>	RN1962	RN2962	<b>RN4902</b>	<b>RN4982</b>
			22	22	22	22	<b>RN1903</b>	<b>RN2903</b>	RN1963	RN2963	<b>RN4903</b>	<b>RN4983</b>
			47	47	47	47	<b>RN1904</b>	<b>RN2904</b>	RN1964	RN2964	<b>RN4904</b>	<b>RN4984</b>
			2.2	47	2.2	47	<b>RN1905</b>	<b>RN2905</b>	RN1965	RN2965	<b>RN4905</b>	<b>RN4985</b>
			4.7	47	4.7	47	<b>RN1906</b>	<b>RN2906</b>	RN1966	RN2966	<b>RN4906</b>	<b>RN4986</b>
			10	47	10	47	<b>RN1907</b>	<b>RN2907</b>	RN1967	RN2967	<b>RN4907</b>	<b>RN4987</b>
			22	47	22	47	<b>RN1908</b>	<b>RN2908</b>	RN1968	RN2968	<b>RN4908</b>	<b>RN4988</b>
			47	22	47	22	<b>RN1909</b>	<b>RN2909</b>	RN1969	RN2969	<b>RN4909</b>	<b>RN4989</b>
			4.7	—	4.7	—	<b>RN1910</b>	<b>RN2910</b>	RN1970	RN2970	<b>RN4910</b>	<b>RN4990</b>
			10	—	10	—	<b>RN1911</b>	<b>RN2911</b>	RN1971	RN2971	<b>RN4911</b>	<b>RN4991</b>
			22	—	22	—						
			47	—	47	—			RN1973			
			1	10	1	10						
			2.2	10	2.2	10				RN2975		
			4.7	10	4.7	10						
			10	4.7	10	4.7						
			47	10	47	10						
			2.2	47	22	47					<b>RN49A1</b>	
			2.2	47	47	47					RN49A2	
22	22	10	10									
10	10	10	—									

- For the PNP transistors, the minus sign (–) indicating a negative voltage is omitted.
- The products shown in bold are also manufactured in offshore fabs.
- Contact the Toshiba sales representative for information about RoHS compliance before you purchase any components.

The internal connection diagrams only show the general configurations of the circuits.

(Dual, General-Purpose (6 Pin) ) (Continued)

Classification	Absolute Maximum Ratings		Internal Resistors				SM6			
	V <sub>CEO</sub> (V)	I <sub>c</sub> (mA)	Q1		Q2		 (mm)			
			(kΩ)		(kΩ)					
			R1	R2	R1	R2	 NPN x 2	 PNP x 2	 NPN x 2	 PNP + NPN
General-purpose	50	100	4.7	4.7	4.7	4.7	<b>RN1601</b>	<b>RN2601</b>		<b>RN4601</b>
			10	10	10	10	<b>RN1602</b>	<b>RN2602</b>		<b>RN4602</b>
			22	22	22	22	<b>RN1603</b>	<b>RN2603</b>		<b>RN4603</b>
			47	47	47	47	<b>RN1604</b>	<b>RN2604</b>		<b>RN4604</b>
			2.2	47	2.2	47	<b>RN1605</b>	<b>RN2605</b>		<b>RN4605</b>
			4.7	47	4.7	47	<b>RN1606</b>	<b>RN2606</b>		<b>RN4606</b>
			10	47	10	47	<b>RN1607</b>	<b>RN2607</b>		<b>RN4607</b>
			22	47	22	47	<b>RN1608</b>	<b>RN2608</b>		<b>RN4608</b>
			47	22	47	22	<b>RN1609</b>	<b>RN2609</b>		<b>RN4609</b>
			4.7	—	4.7	—	<b>RN1610</b>	<b>RN2610</b>		<b>RN4610</b>
			10	—	10	—	<b>RN1611</b>	<b>RN2611</b>		<b>RN4611</b>
			22	—	22	—				RN4612
			47	—	47	—			RN1673	
			1	10	1	10				
			2.2	10	2.2	10				
			4.7	10	4.7	10				
			10	4.7	10	4.7				
			47	10	47	10				
			2.2	47	22	47				
			2.2	47	47	47				
22	22	10	10				RN46A1			
10	10	10	—							

- For the PNP transistors, the minus sign (–) indicating a negative voltage is omitted.
- The products shown in bold are also manufactured in offshore fabs.
- Contact the Toshiba sales representative for information about RoHS compliance before you purchase any components.

The internal connection diagrams only show the general configurations of the circuits.

# Junction FETs

## Junction FETs (Surface-Mount Type)

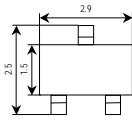
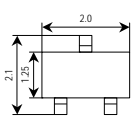
Classification	V <sub>GDS</sub> (V) Max	I <sub>G</sub> (mA) Max	I <sub>DSS</sub> (mA)	Y <sub>fs</sub>   (mS) Min	Package			
					S-MINI (SC-59)		USM (SC-70)	
								
(mm)		(mm)		Nch	Pch	Nch	Pch	
General-purpose	-50	10	0.3 to 6.5	1.2	<b>2SK208</b>		<b>2SK879</b>	
	50	-10	-1.2 to -14	1	2SJ106		2SJ144	
	-50	10	1.2 to 14	4	<b>2SK209</b>		<b>2SK880</b>	

- The products shown in bold are also manufactured in offshore fabs.
- Contact the Toshiba sales representative for information about RoHS compliance before you purchase any components.

## (Surface-Mount Type) (Electret Condense Microphone)

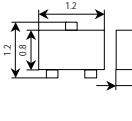
Characteristics	V <sub>GDS</sub> (V) Max	I <sub>G</sub> (mA) Max	I <sub>DSS</sub> Rank ( $\mu$ A)	Y <sub>fs</sub>   (mS) Min	C <sub>iss</sub> (pF) Typ.	Package
						VESM 
High gain Low THD Low Noise Small C <sub>iss</sub>	-20	10	A = 80 to 200 B = 170 to 300	0.55	3.6	2SK3582MFV
High gain Low THD Small C <sub>iss</sub>	-20	10	A = 140 to 240 B = 210 to 350	0.9	3.5	2SK3857MFV
High gain Small C <sub>iss</sub>	-20	10	A = 140 to 240 AK = 100 to 250 B = 210 to 350 BK = 210 to 400 C = 320 to 500	1.35	4.0	2SK4059MFV
Very Low Noise Small C <sub>iss</sub>	-20	10	A = 140 to 240 B = 210 to 350	0.9	1.8	TTK101MFV *

- Contact the Toshiba sales representative for information about RoHS compliance before you purchase any components.
- \*: New product

## Junction FETs (Dual) (Surface-Mount Type)

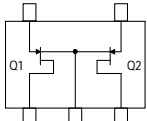
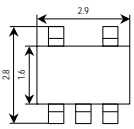
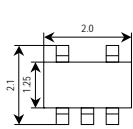
Classification	V <sub>GDS</sub> (V)	I <sub>G</sub> (mA)	I <sub>DSS</sub> (mA)	Y <sub>fs</sub>   (mS) Min	Package				◆ Internal Connections 
					SMV		USV		
									
(mm)		(mm)		Nch x 2	Pch x 2	Nch x 2	Pch x 2		
General-purpose	-50	10	1.2 to 14	4	2SK2145	—	2SK3320	—	

- Contact the Toshiba sales representative for information about RoHS compliance before you purchase any components.
- ◆ The internal connection diagrams only show the general configurations of the circuits.

# Combination Products of Different Type Devices

## Combination Products of Different Type Devices (5-Pin Packages (SMV), 6-Pin Packages (ES6, US6, SM6))

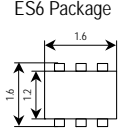
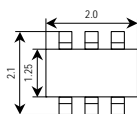
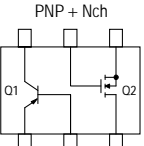
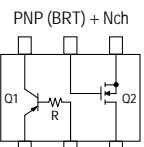
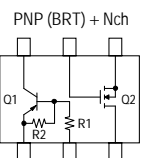
Internal Connections	Part Number		Component Devices	Ratings				Features	
	ES6 Package  (mm)	US6 Package  (mm)		Breakdown Voltage (V)	Current (mA)				
	—	<b>HN7G01FU</b>	Q1	2SA1955	$V_{CE0}$	-12	$I_c$	-400	PNP Low $V_{CE(SAT)}$ , suitable for power supply switches
	—	—	Q2	2SK1829	$V_{DS}$	20	$I_D$	50	2.5-V gate drive ( $V_{th} = 1.5$ V max), $R_{on} = 20 \Omega$ typ.
	HN7G01FE	—	Q1	2SA1955	$V_{CE0}$	-12	$I_c$	-400	PNP Low $V_{CE(SAT)}$ , suitable for power supply switches
	—	—	Q2	SSM3K03FE	$V_{DS}$	20	$I_D$	50	2.5-V gate drive ( $V_{th} = 1.3$ V max), $R_{on} = 4 \Omega$ typ.
	—	<b>HN7G02FU</b>	Q1	RN2310	$V_{CE0}$	-50	$I_c$	-100	PNP (Internal resistors), $R = 4.7$ k $\Omega$
	—	—	Q2	2SK1829	$V_{DS}$	20	$I_D$	50	2.5-V gate drive ( $V_{th} = 1.5$ V max), $R_{on} = 20 \Omega$ typ.
	HN7G02FE	—	Q1	RN2310	$V_{CE0}$	-50	$I_c$	-100	PNP (Internal resistors), $R = 4.7$ k $\Omega$
	—	—	Q2	SSM3K03FE	$V_{DS}$	20	$I_D$	50	2.5-V gate drive ( $V_{th} = 1.3$ V max), $R_{on} = 4 \Omega$ typ.
	—	<b>HN7G05FU</b>	Q1	RN2101	$V_{CE0}$	-50	$I_c$	-100	PNP (Internal resistors), $R_1 = 4.7$ k $\Omega$ , $R_2 = 4.7$ k $\Omega$
	—	—	Q2	2SK1830	$V_{DS}$	20	$I_D$	50	2.5-V gate drive ( $V_{th} = 1.5$ V max), $R_{on} = 20 \Omega$ typ.

• The products shown in bold are also manufactured in offshore fabs.

• Contact the Toshiba sales representative for information about RoHS compliance before you purchase any components.

The internal connection diagrams only show the general configurations of the circuits.

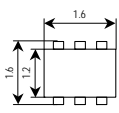
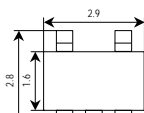
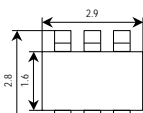
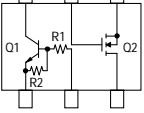
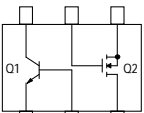
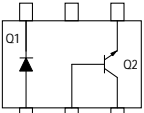
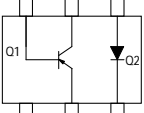
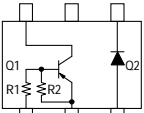

Combination Products of Different Type Devices (5-Pin Packages (SMV), 6-Pin Packages (ES6, US6, SM6) ) (Continued)

Internal Connections	Part Number			Component Devices	Ratings				Features	
	ES6 Package	SMV Package	SM6 Package		Breakdown Voltage (V)		Current (mA)			
	 (mm)	 (mm)	 (mm)							
<p>NPN (BRT) + Nch</p> 	HN7G09FE	—	—	Q1	RN1104F	V <sub>CEO</sub>	50	I <sub>c</sub>	100	NPN (Internal resistors), R1 = 47 kΩ, R2 = 47 kΩ
				Q2	SSM3K15FS	V <sub>DS</sub>	30	I <sub>D</sub>	100	2.5-V gate drive (V <sub>th</sub> = 1.5 V max), Ron = 4 Ω typ..
<p>NPN + Nch</p> 	HN7G10FE	—	—	Q1	2SC5376F	V <sub>CEO</sub>	12	I <sub>c</sub>	400	NPN Low V <sub>CE(SAT)</sub> , suitable for power supply switches
				Q2	SSM3K03FE	V <sub>DS</sub>	20	I <sub>D</sub>	50	2.5-V gate drive (V <sub>th</sub> = 1.3 V max), Ron = 4 Ω typ..
<p>Independent small-signal diode + NPN</p> 	—	—	HN2E01F	Q1	1SS352	V <sub>R</sub>	80	I <sub>o</sub>	100	Standard high-speed switching
				Q2	2SC4666	V <sub>CEO</sub>	50	I <sub>c</sub>	150	High-hFE-type NPN
			HN2E02F	Q1	1SS352	V <sub>R</sub>	80	I <sub>o</sub>	100	Standard high-speed switching
				Q2	2SC4116	V <sub>CEO</sub>	50	I <sub>c</sub>	150	General-purpose NPN transistor
<p>Independent PNP + small-signal diode</p> 	—	—	HN2E04F	Q1	2SA1587	V <sub>CEO</sub>	-120	I <sub>c</sub>	-100	High breakdown voltage PNP
				Q2	1SS352	V <sub>R</sub>	80	I <sub>o</sub>	100	Standard high-speed switching
<p>Independent BRT (PNP) + small-signal diode</p> 	—	HN2E05J	—	Q1	RN2304	V <sub>CEO</sub>	-50	I <sub>c</sub>	-100	PNP (Internal resistors), R1 = 47 kΩ, R2 = 47 kΩ
				Q2	1SS352	V <sub>R</sub>	80	I <sub>o</sub>	100	Standard high-speed switching

• Contact the Toshiba sales representative for information about RoHS compliance before you purchase any components.

The internal connection diagrams only show the general configurations of the circuits.

# MOSFETs

## Small-Signal MOSFETs (Single-Type)

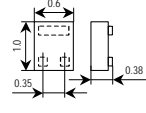
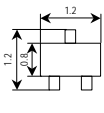
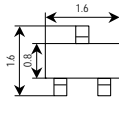
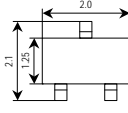
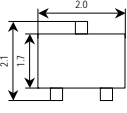
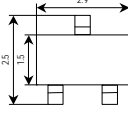
Polarity	Absolute Maximum Ratings			Package					
	V <sub>DS</sub> (V)	V <sub>GSS</sub> (V)	I <sub>D</sub> (mA)	CST3  (mm)	VESM  (mm)	SSM  (mm)	USM (SC-70)  (mm)	UFM  (mm)	S-MINI (SC-59)  (mm)
N-ch	20	±10	200	SSM3K37CT *		SSM3K37FS *			
	20	±10	250		SSM3K37MFV *				
	20	±10	100				SSM3K16FU		
	20	±10	180	SSM3K35CT	SSM3K35MFV	SSM3K35FS			
	20	±10	500		SSM3K36MFV	SSM3K36FS		SSM3K36TU	
	20	±10	500			SSM3K43FS # *			
	30	±20	100						SSM3K15F
	30	±20	100	SSM3K15ACT *	SSM3K15AMFV *	SSM3K15AFS *	SSM3K15AFU *		
	30	±20	100		SSM3K44MFV # *	SSM3K44FS # *			
	30	±20	200						2SK2009
	30	±20	400				SSM3K09FU		
	50	±7	100				SSM3K17FU		
	60	±20	200				SSM3K7002AFU		SSM3K7002AF
60	±20	200			SSM3K7002BFS *	SSM3K7002BFU *		SSM3K7002BF *	
60	±20	200						2SK1062	
P-ch	-20	±8	-330		SSM3J36MFV	SSM3J36FS		SSM3J36TU	
	-20	±10	-100	SSM3J16CT	SSM3J16FV	SSM3J16FS	SSM3J16FU		
	-20	±10	-100	SSM3J35CT	SSM3J35MFV	SSM3J35FS			
	-30	±20	-100	SSM3J15CT	SSM3J15FV	SSM3J15FS	SSM3J15FU		SSM3J15F
	-30	±20	-200					2SJ305	
	-30	±20	-200				SSM3J09FU		
	-50	-7	-50				2SJ344		2SJ343
-60	±20	-200						2SJ168	

#: High ESD protection

- Contact the Toshiba sales representative for information about RoHS compliance before you purchase any components.

Vth (V)		Ron (Ω)			@VGS (V)	ton (ns) Typ.	toff (ns) Typ.
Min	Max	Typ.	Max				
0.35	1.0	3.07	5.6	1.5	18	36	
0.35	1.0	3.07	5.6	1.5	18	36	
0.6	1.1	5.2	15	1.5	70	125	
0.4	1.0	5	20	1.2	115	300	
0.35	1.0	0.95	1.52	1.5	30	75	
0.35	1.0	0.95	1.52	1.5	30	75	
0.8	1.5	4	7	2.5	50	180	
0.8	1.5	3.5	6.0	2.5	5.5	35	
0.8	1.5	4.0	7.0	2.5	50	200	
0.5	1.5	1.2	2.0	2.5	60	120	
1.1	1.8	0.8	1.2	4	72	68	
0.9	1.5	22	40	2.5	100	40	
1.0	2.5	1.8	3.3	4.5	3	7	
1.5	3.1	2.1	3.3	4.5	3.3	14.5	
2.0	3.5	0.6	1.0	10	14	75	
-0.3	-1.0	2.23	3.60	-1.5	90	200	
-0.6	-1.1	18	45	-1.5	130	190	
-0.4	-1.0	11	44	-1.2	175	251	
-1.1	-1.7	14	32	-2.5	65	175	
-0.5	-1.5	2.4	4.0	-2.5	60	150	
-1.1	-1.8	3.3	4.2	-4	85	85	
-0.8	-2.5	20	50	-4	150	130	
-2.0	-3.5	1.3	2.0	-10	14	100	

\*: New product

## Small-Signal MOSFETs (Dual Type)

Polarity	Absolute Maximum Ratings			Package					Internal FETs	V <sub>th</sub> (V)		R <sub>on</sub> (Ω)		@V <sub>GS</sub> (V)
	V <sub>DD</sub> S (V)	V <sub>G</sub> SS (V)	I <sub>D</sub> (mA)	ESV	ES6	USV	US6	UF6		Min	Max	Typ.	Max	
				(mm)	(mm)	(mm)	(mm)	(mm)						
N-ch x 2	20	±10	100	SSM5N16FE ▲1		SSM5N16FU ▲1			SSM3K16FU x 2	0.6	1.1	5.2	15	1.5
	20	±10	250		SSM6N37FE		SSM6N37FU *		SSM3K37MFV x 2	0.35	1.0	3.07	5.6	1.5
	20	±10	180		SSM6N35FE ▲1		SSM6N35FU ▲1		SSM3K35MFV x 2	0.4	1.0	5	20	1.2
	20	±10	500		SSM6N36FE ▲1			SSM6N36TU ▲1	SSM3K36TU x 2	0.35	1.0	0.95	1.52	1.5
	20	±10	500					SSM6N43FU ▲1	SSM3K43FS x 2	0.35	1.0	0.95	1.52	1.5
	30	±20	100	SSM5N15FE ▲1		SSM5N15FU ▲1			SSM3K15FU x 2	0.8	1.5	4	7	2.5
	30	±20	100		SSM6N15AFE *		SSM6N15AFU *		SSM3K15AMFV x 2	0.8	1.5	3.5	6.0	2.5
	30	±20	100		SSM6N44FE ▲1		SSM6N44FU ▲1		SSM3K44FS x 2	0.8	1.5	4.0	7.0	2.5
	30	±20	400					SSM6N09FU ▲1	SSM3K09FU x 2	1.1	1.8	0.8	1.2	4
	50	±7	100					SSM6N17FU ▲1	SSM3K17FU x 2	0.9	1.5	22	40	2.5
P-ch x 2	60	±20	200				SSM6N7002AFU ▲1	SSM3K7002AFU x 2	1.0	2.5	1.8	3.3	4.5	
	60	±20	200		SSM6N7002BFE ▲1 *		SSM6N7002BFU ▲1 *	SSM3K7002BF x 2	1.5	3.1	2.1	3.3	4.5	
	-20	±10	-100	SSM5P16FE ▲2	SSM6P16FE ▲2	SSM5P16FU ▲2	SSM6P16FU ▲2		SSM3J16FU x 2	-0.6	-1.1	18	45	-1.5
	-20	±10	-100		SSM6P35FE ▲2		SSM6P35FU ▲2		SSM3J35FU x 2	-0.4	-1.0	11	44	-1.2
	-20	±8	-330		SSM6P36FE ▲2 *			SSM6P36TU ▲2 *	SSM3J36TU x 2	-0.3	-1.0	2.23	3.6	-1.5
N-ch + P-ch	-30	±20	-200				SSM6P09FU ▲2		SSM3J09FU x 2	-1.1	-1.8	3.3	4.2	-4
	-30	±20	-100	SSM5P15FE ▲2	SSM6P15FE ▲2	SSM5P15FU ▲2	SSM6P15FU ▲2		SSM3J15FU x 2	-1.1	-1.7	14	32	-2.5
	20	±10	180					SSM3K35FU	0.4	1.0	5	20	1.2	
	-20	±10	-100		SSM6L35FE ▲3		SSM6L35FU ▲3		+ SSM3J35FU	-0.4	-1.0	11	4.4	-1.2
	20	±10	500					SSM6L36TU ▲3 *	SSM3K36TU	0.35	1.0	0.95	1.52	1.5
	-20	±8	-330		SSM6L36FE ▲3 *				+ SSM3J36TU	-0.3	-1.0	2.23	3.6	-1.5
30	±20	400				SSM6L09FU ▲3		SSM3K09FU	1.1	1.8	0.8	1.2	4	
-30	±20	-200						SSM3J09FU	-1.1	-1.8	3.3	4.2	-4	

• Contact the Toshiba sales representative for information about RoHS compliance before you purchase any components.

\*: New product

### ◆Internal Connections

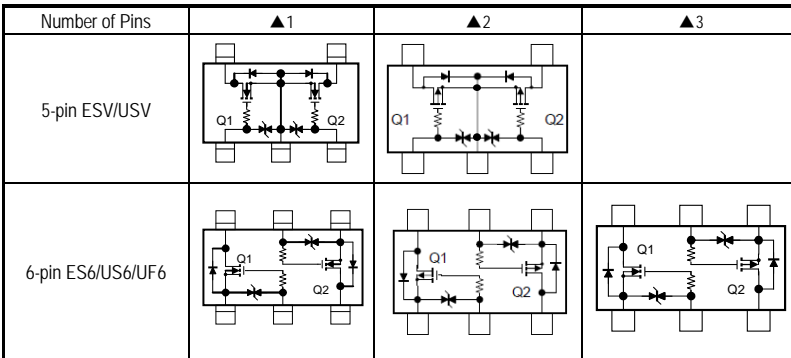

◆The internal connection diagrams only show the general configurations of the circuits.

VDSS ≤ 60 V (Power MOSFETs) (N-ch MOSFETs)

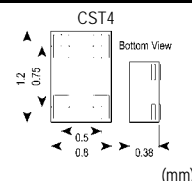
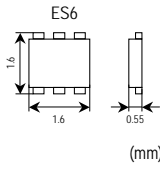
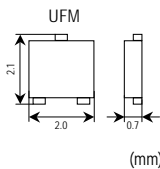
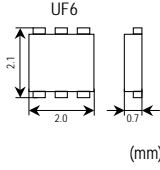
Package	Polarity	Part Number	V <sub>bss</sub> (V)	V <sub>gss</sub> (V)	I <sub>d</sub> (A)	P <sub>d</sub> (W)	R <sub>ds(ON)</sub> Max (mΩ)				C <sub>iss</sub> (pF)	Internal FETs	Internal Connections
							V <sub>GS</sub> = 1.5 V	V <sub>GS</sub> = 1.8 V	V <sub>GS</sub> = 2.5 V	V <sub>GS</sub> = 4.0 V			
 CST4 (mm)	N-ch	SSM4K27CT	20	±12	0.5	0.4	—	390	260	205	174	—	(4)
 ES6 (mm)	N-ch	SSM6K211FE	20	±10	3.2	0.5	118	82	59	47(@4.5 V)	510	—	(2)
		SSM6K202FE	30	±12	2.3	0.5	—	145	101	85	270	—	(2)
		SSM6K204FE	20	±10	2.0	0.5	307	214	164	126	195	—	(2)
		SSM6K208FE	30	±12	1.9	0.5	—	296	177	133	123	—	(2)
		SSM6K210FE	30	±20	1.4	0.5	—	—	—	371	57	—	(2)
		SSM6K30FE	20	±20	1.2	0.5	—	—	—	420	60	—	(2)
		SSM6K31FE	20	±20	1.2	0.5	—	—	—	540	36	—	(2)
 UFM (mm)	N-ch	SSM6N42FE *	20	±10	0.8	0.15	600	450	330	240(@4.5 V)	90	—	(1)
		SSM3K123TU	20	±10	4.2	0.5	66	43	32	28	1010	—	(3)
		SSM3K121TU	20	±10	3.2	0.5	140	93	63	48	400	—	(3)
		SSM3K119TU	30	±12	2.5	0.5	—	134	90	74	270	—	(3)
		SSM3K116TU	30	±12	2.2	0.5	—	—	135	100(@4.5 V)	245	—	(3)
		SSM3K122TU	20	±10	2.0	0.5	304	211	161	123	195	—	(3)
		SSM3K127TU	30	±12	2.0	0.5	—	286	167	123	123	—	(3)
		SSM3K131TU	30	±20	6.0	0.5	—	—	—	41.5(@4.5 V)	450	—	(3)
 UF6 (mm)	N-ch	SSM3K124TU	30	±20	2.4	0.5	—	—	—	120	180	—	(3)
		SSM3K106TU	20	±20	1.2	0.5	—	—	—	530	36	—	(3)
		SSM6K403TU	20	±10	4.2	0.5	66	43	32	28	1050	—	(2)
		SSM6K411TU *	20	±12	10	0.5	—	—	23.8	12(@4.5 V)	710	—	(2)
		SSM6K404TU	20	±10	3.0	0.5	147	100	70	55	400	—	(2)
		SSM6K405TU	20	±10	2.0	0.5	307	214	164	126	195	—	(2)
		SSM6K406TU	30	±20	4.4	0.5	—	—	—	38.5(@4.5 V)	490	—	(2)
	SSM6K34TU	30	±20	3.0	0.5	—	—	—	77(@4.5 V)	470	—	(2)	
	SSM6K407TU	60	±20	2.0	0.5	—	—	—	440	150	—	(2)	
	N-ch x 2	SSM6N39TU	20	±10	1.6	0.5	247	190	139	119	260	—	(1)
SSM6N24TU		30	±12	0.5	0.5	—	—	180	145(@4.5 V)	245	SSM6K24FE x 2	(1)	
SSM6N40TU		30	±20	1.6	0.5	—	—	—	182	180	—	(1)	

#: High ESD protection

\*: New product

• Contact the Toshiba sales representative for information about RoHS compliance before you purchase any components.

◆ Internal Connections

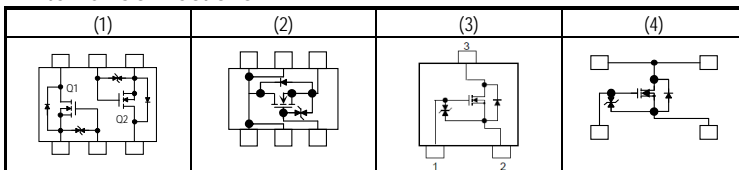

Note: Some MOSFETs do not have a Zener diode between gate and source.

◆ The internal connection diagrams only show the general configurations of the circuits.

VDSS ≤ 60 V (Power MOSFETs) (N-ch MOSFETs) (Continued)

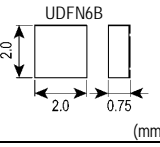
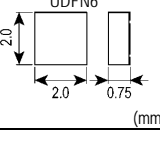
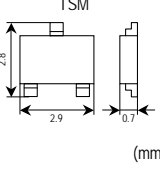
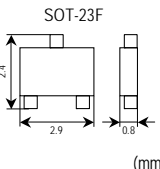
Package	Polarity	Part Number	V <sub>DSS</sub> (V)	V <sub>GSS</sub> (V)	I <sub>D</sub> (A)	P <sub>D</sub> (W)	R <sub>DS(ON)</sub> Max (mΩ)							C <sub>iss</sub> (pF)	Q <sub>g</sub> (nC) (typ.)	Internal Connections
							V <sub>GS</sub> = 1.5 V	V <sub>GS</sub> = 1.8 V	V <sub>GS</sub> = 2.0 V	V <sub>GS</sub> = 2.5 V	V <sub>GS</sub> = 4 V	V <sub>GS</sub> = 4.5 V	V <sub>GS</sub> = 10 V			
	N-ch	SSM6K504NU **	30	±20	9	2	—	—	—	—	—	30	650	650	5	(1)
	N-ch x 2	SSM6N55NU **	30	±20	4	2	—	—	—	—	—	64	43	270	2.5	(2)
	N-ch	SSM3K310T	20	±10	5.0	0.7	66	43	—	32	28	—	—	1120	14.8	(3)
		SSM3K309T	20	±12	4.7	0.7	—	47	—	35	31	—	—	1020	—	(3)
		SSM3K301T	20	±12	3.5	0.7	—	110	—	74	56	—	—	320	4.8	(3)
		SSM3K316T	30	±12	4.0	1.25	—	131	—	87	—	65	53	270	4.3	(3)
		SSM3K320T	30	±20	4.2	1.4	—	—	—	—	—	77	50	190	4.6	(3)
		SSM3K318T *	60	±20	2.5	0.7	—	—	—	—	—	—	145	107	235	7
	N-ch	SSM3K329R *	30	±12	3.5	2	—	289	—	170	—	126	—	123	—	(3)
		SSM3K333R *	30	±20	6	2	—	—	—	42	—	28	—	436	—	(3)
		SSM3K335R *	30	±20	6	2	—	—	—	—	—	57	35	340	2.6	(3)
		SSM3K336R **	30	±20	4	2	—	—	—	—	—	140	110	110	1	(3)

• Contact the Toshiba sales representative for information about RoHS compliance before you purchase any components.

\*: New product

\*\* : Under development

◆ Internal Connections

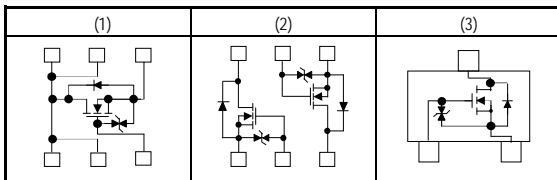

Note: Some MOSFETs do not have a Zener diode between gate and source.

◆ The internal connection diagrams only show the general configurations of the circuits.

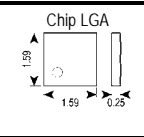
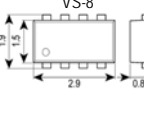
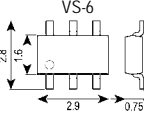
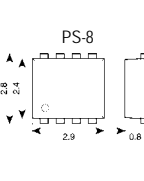
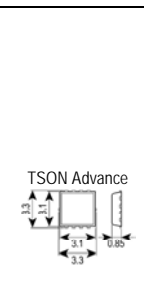
Package	Polarity	Part Number	V <sub>DSS</sub> (V)	V <sub>GSS</sub> (V)	I <sub>D</sub> (A)	P <sub>D</sub> (W)	R <sub>DS(ON)</sub> Max (mΩ)					Q <sub>g</sub> (nC) (typ.)	Internal Connections
							V <sub>GS</sub> = 2.0 V	V <sub>GS</sub> = 2.5 V	V <sub>GS</sub> = 4 V	V <sub>GS</sub> = 4.5 V	V <sub>GS</sub> = 10 V		
 Chip LGA (mm)	N-ch Dual	TPCL4201	20	±12	6	1.65	—	52	33	31	—	11.5	(1)
		TPCL4203	24	±12	6	1.65	—	55	38	36	—	10	(1)
		TPCL4202	30	±12	6	1.65	—	64	42	40	—	10	(1)
 VS-8 (mm)	N-ch Single	TPCF8003	20	±12	7	2.5	—	34	—	18	—	9.5	(2)
	N-ch Dual	TPCF8201	20	±12	3	1.35	100	66	—	49	—	7.5	(3)
 VS-6 (mm)	N-ch Single	TPC6012	20	±12	6	2.2	—	38	—	20	—	9	(4)
		TPC6008-H	30	±20	5.9	2.2	—	—	—	74	60	4.8	(4)
		TPC6011	30	±20	6	2.2	—	—	—	32	20	14	(4)
		TPC6009-H	40	±20	5.3	2.2	—	—	—	98	81	4.7	(4)
		TPC6010-H	60	±20	6.1	2.2	—	—	—	63	59	12	(4)
 PS-8 (mm)	N-ch Single	TPCP8006	20	±12	9.1	1.68	—	13.7	—	10	—	22	(5)
		TPCP8008-H	30	±20	8	1.68	—	—	—	23	20	14.7	(5)
		TPCP8004	30	±20	8.3	1.68	—	—	—	14	8.5	26	(5)
		TPCP8005-H	30	±20	11	1.68	—	—	—	15.7	12.9	20	(5)
	N-ch Dual	TPCP8007-H	60	±20	5	1.68	—	—	—	64	57	11	(5)
		TPCP8204	30	±20	4.2	1.48	—	—	—	77	50	4.6	(3)
		TPCP8205-H	30	±20	6.5	1.48	—	—	—	29	26	13.8	(3)
 TSON Advance (mm)	N-ch Single	TPCC8007	20	±12	27	30	—	8.7	—	4.6	—	26	(5)
		TPCC8061-H	30	±20	8	15	—	—	—	29	26	11	(5)
		TPCC8067-H	30	±20	9	15	—	—	—	33	25	9.5	(5)
		TPCC8066-H	30	±20	11	17	—	—	—	19	15	15	(5)
		TPCC8003-H	30	±20	13	22	—	—	—	19.3	16.9	17	(5)
		TPCC8065-H	30	±20	13	18	—	—	—	14.5	11.4	20	(5)
		TPCC8064-H	30	±20	19	30	—	—	—	10.6	8.2	23	(5)
		TPCC8074	30	±20	20	30	—	—	—	8.5	6.3	25	(5)
		TPCC8006-H	30	±20	22	27	—	—	—	9.3	8	27	(5)
		TPCC8009	30	±20	24	27	—	—	—	—	7	26	(5)
		TPCC8005-H	30	±20	26	30	—	—	—	7.4	6.4	35	(5)
		TPCC8062-H	30	±20	27	39	—	—	—	7.1	5.6	34	(5)
		TPCC8073	30	±20	27	39	—	—	—	5.9	4.5	37	(5)
		TPCC8008	30	±25	25	30	—	—	—	13	6.8	30	(5)
		TPCC8084	33	±20	21	32	—	—	—	9	6.7	27	(5)
		TPCC8076	33	±20	27	39	—	—	—	6.2	4.6	34	(5)

• Contact the Toshiba sales representative for information about RoHS compliance before you purchase any components.

### ◆Internal Connections

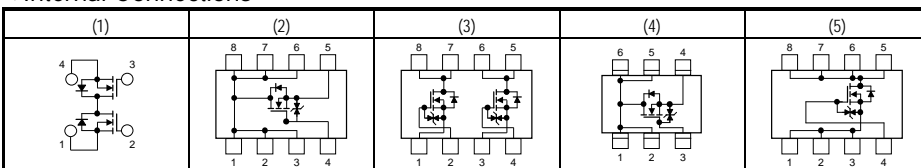

Note: Some MOSFETs do not have a Zener diode between gate and source.

◆The internal connection diagrams only show the general configurations of the circuits.

VDSS ≤ 60 V (Power MOSFETs) (N-ch MOSFETs) (Continued)

Package	Polarity	Part Number	V <sub>bss</sub> (V)	V <sub>gss</sub> (V)	I <sub>d</sub> (A)	P <sub>D</sub> (W)	R <sub>DS(ON)</sub> Max (mΩ)					Q <sub>g</sub> (nC) (typ.)	Internal Connections
							V <sub>GS</sub> = 2.0 V	V <sub>GS</sub> = 2.5 V	V <sub>GS</sub> = 4 V	V <sub>GS</sub> = 4.5 V	V <sub>GS</sub> = 10 V		
	N-ch Single	TPC8061-H	30	±20	8	1.9	—	—	—	29	26	11	(1)
		TPC8067-H	30	±20	9	1.9	—	—	—	33	25	9.5	(1)
		TPC8066-H	30	±20	11	1.9	—	—	—	19	16	15	(1)
		TPC8037-H	30	±20	12	1.9	—	—	—	13.9	11.4	21	(1)
		TPC8038-H	30	±20	12	1.9	—	—	—	13.9	11.4	21	(1)
		TPC8065-H	30	±20	13	1.9	—	—	—	14.7	11.6	20	(1)
		TPC8040-H	30	±20	13	1.9	—	—	—	11.1	9.7	24	(1)
		TPC8032-H	30	±20	15	1.9	—	—	—	8.6	6.5	33	(1)
		TPC8064-H	30	±20	16	1.9	—	—	—	10.8	8.4	23	(1)
		TPC8063-H	30	±20	17	1.9	—	—	—	8.9	7	27	(1)
		TPC8039-H	30	±20	17	1.9	—	—	—	6.9	6	36	(1)
		TPC8033-H	30	±20	17	1.9	—	—	—	7.2	5.3	42	(1)
		TPC8062-H	30	±20	18	1.9	—	—	—	7.3	5.8	34	(1)
		TPC8036-H	30	±20	18	1.9	—	—	—	5.1	4.5	49	(1)
		TPC8059-H	30	±20	18	1.9	—	—	—	5	4	41	(1)
		TPC8060-H	30	±20	18	1.9	—	—	—	4.2	3.7	65	(1)
		TPC8034-H	30	±20	18	1.9	—	—	—	4.5	3.5	68	(1)
		TPC8058-H	30	±20	18	1.9	—	—	—	4	3.2	51	(1)
		TPC8035-H	30	±20	18	1.9	—	—	—	3.6	3.2	82	(1)
		TPC8057-H	30	±20	18	1.9	—	—	—	3.4	2.8	61	(1)
		TPC8056-H	30	±20	18	1.9	—	—	—	2.9	2.4	74	(1)
		TPC8055-H	30	±20	18	1.9	—	—	—	2.5	2.1	91	(1)
		TPC8041	30	±20	13	1.9	—	—	—	13.5	7	27	(1)
		TPC8092	30	±20	15	1.9	—	—	—	11.1	9	25	(1)
		TPC8074	30	±20	17	1.9	—	—	—	8.7	6.5	25	(1)
		TPC8086	30	±20	17	1.9	—	—	—	8.5	6.4	26	(1)
		TPC8073	30	±20	18	1.9	—	—	—	6.1	4.7	37	(1)
		TPC8085	30	±20	18	1.9	—	—	—	6.1	4.7	37	(1)
		TPC8028	30	±20	18	1.9	—	—	—	8	4.3	45	(1)
		TPC8082	30	±20	18	1.9	—	—	—	5	4	41	(1)
		TPC8029	30	±20	18	1.9	—	—	—	7	3.8	49	(1)
		TPC8042	30	±20	18	1.9	—	—	—	6.5	3.4	56	(1)
		TPC8081	30	±20	18	1.9	—	—	—	4	3.2	51	(1)
		TPC8080	30	±20	18	1.9	—	—	—	3.4	2.8	61	(1)
		TPC8027	30	±20	18	1.9	—	—	—	5.5	2.7	113	(1)
		TPC8088	30	±20	18	1.9	—	—	—	2.9	2.4	74	(1)
		TPC8087	30	±20	18	1.9	—	—	—	2.5	2.1	91	(1)
		TPC8084	33	±20	17	1.9	—	—	—	9.2	6.9	27	(1)
		TPC8076	33	±20	18	1.9	—	—	—	6.5	4.9	34	(1)
		TPC8075	33	±20	18	1.9	—	—	—	3.3	2.6	70	(1)
		TPC8078	33	±20	18	1.9	—	—	—	2.8	2.2	90	(1)
		TPC8052-H	40	±20	12	1.9	—	—	—	13.3	11.5	25	(1)
		TPC8047-H	40	±20	16	1.9	—	—	—	8.8	7.6	43	(1)
		TPC8046-H	40	±20	18	1.9	—	—	—	6.6	5.7	57	(1)
		TPC8045-H	40	±20	18	1.9	—	—	—	4.4	3.9	90	(1)
		TPC8053-H	60	±20	9	1.9	—	—	—	24.2	22.5	25	(1)
		TPC8050-H	60	±20	11	1.9	—	—	—	15.6	14.5	41	(1)
		TPC8049-H	60	±20	13	1.9	—	—	—	11.5	10.7	56	(1)
TPC8048-H	60	±20	16	1.9	—	—	—	7.4	6.9	87	(1)		

• Contact the Toshiba sales representative for information about RoHS compliance before you purchase any components.

◆ Internal Connections

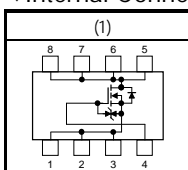

Note: Some MOSFETs do not have a Zener diode between gate and source.

◆ The internal connection diagrams only show the general configurations of the circuits.

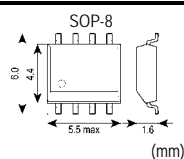
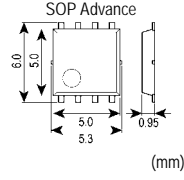
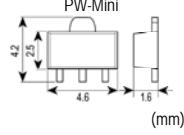
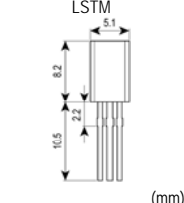

Package	Polarity	Part Number	V <sub>DSS</sub> (V)	V <sub>GSS</sub> (V)	I <sub>D</sub> (A)	P <sub>D</sub> (W)	R <sub>DS(ON)</sub> Max (mΩ)					Q <sub>g</sub> (nC) (typ.)	Internal Connections
							V <sub>GS</sub> = 2.0 V	V <sub>GS</sub> = 2.5 V	V <sub>GS</sub> = 4 V	V <sub>GS</sub> = 4.5 V	V <sub>GS</sub> = 10 V		
	N-ch Dual	TPC8221-H	30	±20	6	1.5	—	—	—	29	25	12	(1)
		TPC8224-H	30	±20	8	1.6	—	—	—	34	26	9.5	(1)
		TPC8223-H	30	±20	9	1.5	—	—	—	21	17	17	(1)
	N-ch Single	TPCA8011-H	20	±12	40	45	—	7.5	—	3.5	—	32	(2)
		TPCA8063-H	30	±20	22	35	—	—	—	8.7	6.8	27	(2)
		TPCA8040-H	30	±20	23	30	—	—	—	10.8	9.4	23	(2)
		TPCA8065-H	30	±20	16	25	—	—	—	14.5	11.4	20	(2)
		TPCA8030-H	30	±20	24	30	—	—	—	13.4	11	21	(2)
		TPCA8031-H	30	±20	24	30	—	—	—	13.4	11	21	(2)
		TPCA8064-H	30	±20	20	32	—	—	—	10.6	8.2	23	(2)
		TPCA8062-H	30	±20	28	42	—	—	—	7.1	5.6	34	(2)
		TPCA8059-H	30	±20	32	45	—	—	—	4.8	3.8	41	(2)
		TPCA8039-H	30	±20	34	45	—	—	—	6.6	5.7	36	(2)
		TPCA8058-H	30	±20	38	52	—	—	—	3.8	3	51	(2)
		TPCA8036-H	30	±20	38	45	—	—	—	4.8	4.2	50	(2)
		TPCA8057-H	30	±20	42	57	—	—	—	3.2	2.6	61	(2)
		TPCA8060-H	30	±20	45	45	—	—	—	3.9	3.4	66	(2)
		TPCA8056-H	30	±20	48	63	—	—	—	2.7	2.2	74	(2)
		TPCA8028-H	30	±20	50	45	—	—	—	3.2	2.8	88	(2)
		TPCA8055-H	30	±20	56	70	—	—	—	2.3	1.9	91	(2)
		TPCA8082	30	±20	32	45	—	—	—	4.8	3.8	41	(2)
		TPCA8024	30	±20	35	45	—	—	—	7.8	4.3	45	(2)
		TPCA8081	30	±20	38	52	—	—	—	3.8	3	51	(2)
		TPCA8025	30	±20	40	45	—	—	—	6	3.5	49	(2)
		TPCA8080	30	±20	42	57	—	—	—	3.2	2.6	61	(2)
		TPCA8026	30	±20	45	45	—	—	—	4.5	2.2	113	(2)
		TPCA8042	30	±20	45	45	—	—	—	5.7	3.3	56	(2)
		TPCA8088	30	±20	48	63	—	—	—	2.7	2.2	74	(2)
		TPCA8087	30	±20	56	70	—	—	—	2.3	1.9	91	(2)
TPCA8052-H	40	±20	20	30	—	—	—	13.1	11.3	25	(2)		
TPCA8047-H	40	±20	32	45	—	—	—	8.5	7.3	43	(2)		
TPCA8046-H	40	±20	38	45	—	—	—	6.3	5.4	55	(2)		
TPCA8045-H	40	±20	46	45	—	—	—	4.1	3.6	90	(2)		
TPCA8053-H	60	±20	15	30	—	—	—	24	22.3	25	(2)		
TPCA8050-H	60	±20	24	45	—	—	—	15.3	14.2	41	(2)		
TPCA8049-H	60	±20	28	45	—	—	—	11.2	10.4	55	(2)		
	N-ch Single	2SK2615	60	—	2	1.5	—	—	440	—	300	6	
		2SK3658	60	—	2	1.5	—	—	440	—	300	5	
	N-ch Single	2SK2989	50	—	5	0.9	—	—	330	—	150	6.5	
		2SK2961	60	—	2	0.9	—	—	380	—	270	5.8	

• Contact the Toshiba sales representative for information about RoHS compliance before you purchase any components.

### ◆ Internal Connections

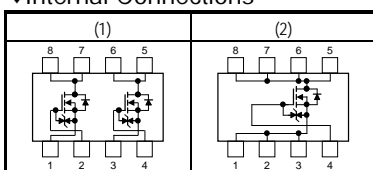

Note: Some MOSFETs do not have a Zener diode between gate and source.

◆ The internal connection diagrams only show the general configurations of the circuits.

VDSS ≤ 60 V (Power MOSFETs) (N-ch MOSFETs) (Continued)

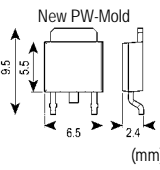
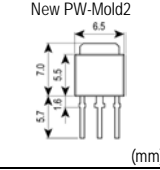
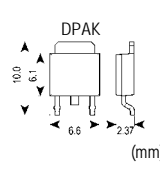
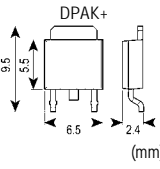
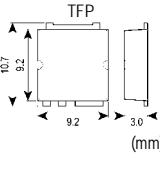
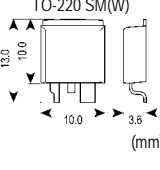
Package	Polarity	Part Number	V <sub>bss</sub> (V)	V <sub>GSS</sub> (V)	I <sub>D</sub> (A)	P <sub>D</sub> (W)	R <sub>DS(ON)</sub> Max (mΩ)						Q <sub>g</sub> (nC) (typ.)	Internal Connections
							V <sub>GS</sub> = 2.0 V	V <sub>GS</sub> = 2.5 V	V <sub>GS</sub> = 4 V	V <sub>GS</sub> = 4.5 V	V <sub>GS</sub> = 6 V	V <sub>GS</sub> = 10 V		
 New PW-Mold (mm)	N-ch Single	2SK2493	16	—	5	20	—	120	100	—	—	—	23	
		2SK4033	60	—	5	20	—	—	150	—	—	100	15	
 New PW-Mold2 (mm)	N-ch Single	2SK4017	60	—	5	20	—	—	150	—	—	100	15	
 DPAK (mm)	N-ch Single	TK40P03M1	30	±20	40	40	—	—	—	14.4	—	10.8	9.4	
		TK45P03M1	30	±20	45	39	—	—	—	12	—	9.7	13	
		TK50P03M1	30	±20	50	60	—	—	—	9.8	—	7.5	13.3	
		TK60P03M1	30	±20	60	63	—	—	—	7.8	—	6.4	21	
		TK20P04M1	40	±20	20	27	—	—	—	34	—	29	7.6	
		TK50P04M1	40	±20	50	60	—	—	—	13.4	—	11	15	
 DPAK+ (mm)	N-ch Single	TK10S04K3L	40	±20	10	25	—	—	—	—	54	28	10	
		TK20S04K3L	40	±20	20	38	—	—	—	—	26	14	18	
		TK35S04K3L	40	±20	35	58	—	—	—	—	15	10.3	28	
		TK65S04K3L	40	±20	65	88	—	—	—	—	7.9	4.5	63	
		TK80S04K3L	40	±20	80	100	—	—	—	—	4.8	3.1	87	
		TK8S06K3L	60	±20	8	25	—	—	—	—	80	54	10	
		TK20S06K3L	60	±20	20	38	—	—	—	—	40	29	18	
		TK30S06K3L	60	±20	30	58	—	—	—	—	30	18	28	
 TFP (mm)	N-ch Single	TK60S06K3L	60	±20	60	88	—	—	—	—	12.3	8	60	
		TK80S06K3L	60	±20	80	100	—	—	—	—	7.8	5.5	85	
		TK70X04K3	40	±20	70	80	—	—	—	—	—	5.6	62	
		TK70X04K3Z	40	±20	70	80	—	—	—	—	—	5.6	62	
		TK80X04K3	40	±20	80	125	—	—	—	—	—	3.5	100	
		TK80X04K3L	40	±20	80	125	—	—	—	—	4.2	3.5	105	
		TK70X06K3	60	±20	70	80	—	—	—	—	—	8	62	
 TO-220 SM(W) (mm)	N-ch Single	2SK3842	60	±20	75	125	—	—	—	—	—	5.8	196	
		2SK4034	60	±20	75	125	—	—	—	10	—	5.8	196	
		TK100F04K3	40	±20	100	200	—	—	—	—	—	3	102	
		TK100F04K3L	40	±20	100	200	—	—	—	—	4.5	3	105	
		TK150F04K3	40	±20	150	300	—	—	—	—	—	2.1	166	
		TK150F04K3L	40	±20	150	300	—	—	—	—	3.2	2.1	190	
		TK100F06K3	60	±20	100	200	—	—	—	—	—	5	98	
		TK130F06K3	60	±20	130	300	—	—	—	—	—	3.4	170	

• Contact the Toshiba sales representative for information about RoHS compliance before you purchase any components.

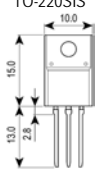
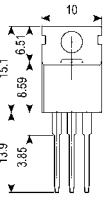
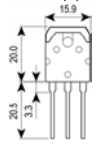
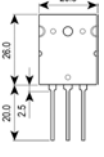
Package	Polarity	Part Number	V <sub>DS</sub> (V)	I <sub>D</sub> (A)	P <sub>D</sub> (W)	R <sub>DS(ON)</sub> Max (mΩ)					Q <sub>g</sub> (nC) (typ.)	Internal Connections
						V <sub>GS</sub> = 2.0 V	V <sub>GS</sub> = 2.5 V	V <sub>GS</sub> = 4 V	V <sub>GS</sub> = 4.5 V	V <sub>GS</sub> = 10 V		
 TO-220SIS (mm)	N-ch Single	TK50A04K3	40	50	42	—	—	—	—	3.5	102	
		TK30A06J3A	60	30	25	—	—	—	35	26	36	
		TK75A06K3	60	75	35	—	—	—	—	5.5	85	
 TO-220 (mm)	N-ch Single	TK25E06K3	60	25	64	—	—	—	—	18	29	
		TK50E06K3A	60	50	104	—	—	—	—	8.5	54	
		TK80E06K3A	60	80	125	—	—	—	—	5.8	90	
 TO-3P(N) (mm)	N-ch Single	TK70J04K3Z	40	70	125	—	—	—	—	3.9	100	
		TK75J04K3Z	40	75	150	—	—	—	—	3.0	190	
		TK70J06K3	60	70	125	—	—	—	—	6	98	
 TO-3P(L) (mm)	N-ch Single	2SK2267	60	60	150	—	—	15	—	11	170	

- Contact the Toshiba sales representative for information about RoHS compliance before you purchase any components.

60 V < V<sub>DSS</sub> ≤ 300 V (Power MOSFETs) (N-ch MOSFETs)

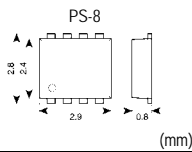
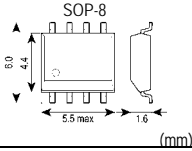
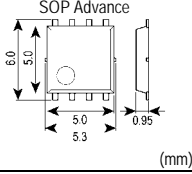
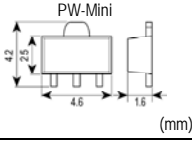
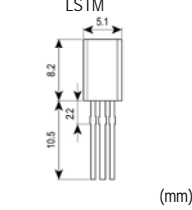
Package	Polarity	Part Number	V <sub>DSS</sub> (V)	V <sub>GSS</sub> (V)	I <sub>D</sub> (A)	P <sub>D</sub> (W)	R <sub>DS(ON)</sub> Max (mΩ)							Q <sub>g</sub> (nC) (typ.)	Internal Connections	
							V <sub>GS</sub> = 1.8 V	V <sub>GS</sub> = 2.0 V	V <sub>GS</sub> = 2.5 V	V <sub>GS</sub> = 4 V	V <sub>GS</sub> = 4.5 V	V <sub>GS</sub> = 7 V	V <sub>GS</sub> = 10 V			
 (mm)	N-ch Single	TPCP8003-H	100	±20	2.2	1.68	—	—	—	—	190	—	180	7.5	(1)	
 (mm)	N-ch Single	TPC8051-H	80	±20	13	1.9	—	—	—	—	10.1	—	9.7	85	(1)	
		TPC8012-H	200	±20	1.8	1.9	—	—	—	—	—	—	—	400	11	(1)
 (mm)	N-ch Single	TPCA8070-H	80	±25	12	45	—	—	—	—	—	—	35	21	(1)	
		TPCA8051-H	80	±20	28	45	—	—	—	—	9.8	—	9.4	91	(1)	
		TPCA8006-H	100	±20	18	45	—	—	—	—	—	—	67	12	(1)	
		TPCA8009-H	150	±20	7	45	—	—	—	—	—	—	—	350	10	(1)
		TPCA8010-H	200	±20	5.5	45	—	—	—	—	—	—	—	450	10	(1)
 (mm)	N-ch Single	2SK2963	100	—	1	1.5	—	—	—	950	—	—	700	6.3		
		2SK2992	200	—	1	1.5	—	—	—	—	—	—	—	3500	3	
 (mm)	N-ch Single	2SK2962	100	—	1	0.9	—	—	—	950	—	—	700	6.3		
		2SK3670	150	—	0.67	0.9	—	—	—	1700	—	—	—	4.6		

• Contact the Toshiba sales representative for information about RoHS compliance before you purchase any components.

◆ Internal Connections

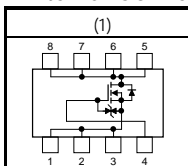

Note: Some MOSFETs do not have a Zener diode between gate and source.

◆ The internal connection diagrams only show the general configurations of the circuits.

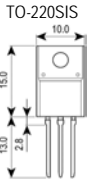
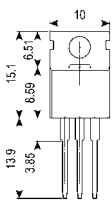
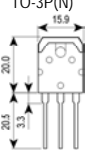
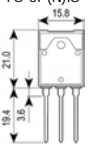

60 V < V<sub>DSS</sub> ≤ 300 V (Power MOSFETs) (N-ch MOSFETs) (Continued)

Package	Polarity	Part Number	V <sub>DSS</sub> (V)	V <sub>GSS</sub> (V)	I <sub>D</sub> (A)	P <sub>D</sub> (W)	R <sub>DS(ON)</sub> Max (mΩ)							Q <sub>g</sub> (nC) (typ.)	Internal Connections
							V <sub>GS</sub> = 1.8 V	V <sub>GS</sub> = 2.0 V	V <sub>GS</sub> = 2.5 V	V <sub>GS</sub> = 4 V	V <sub>GS</sub> = 4.5 V	V <sub>GS</sub> = 7 V	V <sub>GS</sub> = 10 V		
 <p>TO-220SIS (mm)</p>	N-ch Single	TK40A08K3	75	±20	40	42	—	—	—	—	—	—	9	80	
		TK60A08J1	75	±20	60	45	—	—	—	—	9.3	—	7.8	86	
		TK80A08K3	75	±20	80	40	—	—	—	—	—	—	4.5	175	
		TK8A10K3	100	±20	8	18	—	—	—	—	—	—	120	12.9	
		TK12A10K3	100	±20	12	20	—	—	—	—	—	—	80	18	
		TK25A10K3	100	±20	25	25	—	—	—	—	—	—	40	34	
		TK40A10J1	100	±20	40	40	—	—	—	—	17	—	15	76	
		TK40A10K3	100	±20	40	40	—	—	—	—	—	—	15	85	
		TK55A10J1	100	±20	55	45	—	—	—	—	12	—	10.5	110	
		TK9A20DA	200	±20	8.5	30	—	—	—	—	—	—	400	14	
		TK15A20D	200	±20	15	35	—	—	—	—	—	—	180	26	
		TK8A25DA	250	±20	7.5	30	—	—	—	—	—	—	500	16	
		TK13A25D	250	±20	13	35	—	—	—	—	—	—	250	25	
		TK20A25D	250	±20	20	45	—	—	—	—	—	—	100	55	
 <p>TO-220 (mm)</p>	N-ch Single	TK50E08K3	75	±20	50	104	—	—	—	—	—	12	55		
		TK60E08K3	75	±20	60	128	—	—	—	—	—	—	9	75	
		TK18E10K3	100	±20	18	71	—	—	—	—	—	—	42	33	
		TK40E10K3	100	±20	40	147	—	—	—	—	—	—	15	84	
		TK13E25D	250	±20	13	102	—	—	—	—	—	—	250	25	
 <p>TO-3P(N) (mm)</p>	N-ch Single	2SK3940	75	—	70	150	—	—	—	—	—	7	200		
		2SK3497	180	—	10	130	—	—	—	—	150	—	36		
		TK40J20D	200	±20	40	260	—	—	—	—	—	—	44	100	
		TK70J20D	200	±20	70	410	—	—	—	—	—	—	30	160	
		TK30J25D	250	±20	30	260	—	—	—	—	—	—	60	100	
		TK60J25D	250	±20	60	410	—	—	—	—	—	—	38	160	
		TK50J30D	300	±20	50	410	—	—	—	—	—	—	52	160	
 <p>TO-3P(N)IS (mm)</p>	N-ch Single	2SK2995	250	—	30	90	—	—	—	—	—	68	132		

• Contact the Toshiba sales representative for information about RoHS compliance before you purchase any components.

300 V < V<sub>DSS</sub> ≤ 700 V (Power MOSFETs) (N-ch MOSFETs)

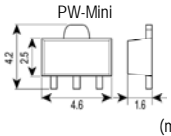
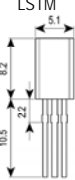
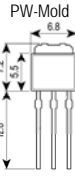
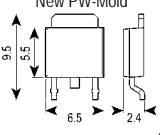
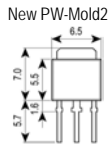
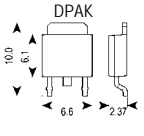
Package	Polarity	Part Number	V <sub>DSS</sub> (V)	I <sub>D</sub> (A)	P <sub>D</sub> (W)	R <sub>DS(ON)</sub> Max (Ω)	Q <sub>g</sub> (nC) (typ.)	Internal Connections
						V <sub>GS</sub> = 10 V		
 (mm)	N-ch Single	2SK3471	500	0.5	1.5	18	3.8	
 (mm)	N-ch Single	2SK2998	500	0.5	0.9	18	3.8	
 (mm)	N-ch Single	2SK3373	500	2	20	3.2	9	
 (mm)	N-ch Single	TK2P60D	600	2	60	4.3	7	
 (mm)	N-ch Single	2SK4023	450	1	20	4.6	5	
		2SK4026	600	1	20	9.0	9	
		TK2Q60D	600	2	60	4.3	7	
		2SK4003	600	3	20	2.2	15	
 (mm)	N-ch Single	TK3P50D	500	3	60	3.0	7	
		TK4P50D	500	4	80	2.0	9	
		TK5P50D	500	5	80	1.5	11	
		TK7P50D	500	7	100	1.22	12	
		TK5P53D	525	5	80	1.5	11	
		TK6P53D	525	6	100	1.3	12	
		TK4P55DA	550	3.5	80	2.45	9	
		TK4P55D	550	4	80	1.88	11	
		TK4P60DA	600	3.5	80	1.7	11	
		TK4P60DB	600	3.7	80	2.0	11	

• Contact the Toshiba sales representative for information about RoHS compliance before you purchase any components.

300 V < V<sub>DSS</sub> ≤ 700 V (Power MOSFETs) (N-ch MOSFETs) (Continued)

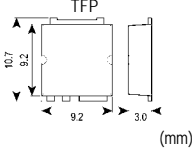
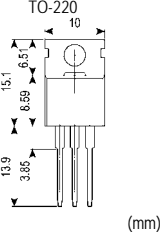
Package	Polarity	Part Number	V <sub>DSS</sub> (V)	I <sub>D</sub> (A)	P <sub>D</sub> (W)	R <sub>DS(ON)</sub> Max (Ω)	Q <sub>g</sub> (nC) (typ.)	Internal Connections
						V <sub>GS</sub> = 10 V		
 <p>TFP (mm)</p>	N-ch Single	TK10X40D	400	10	125	0.55	20	
		2SK3544	450	13	100	0.4	34	
		2SK3466	500	5	50	1.5	17	
		2SK3538	500	8	65	0.85	30	
		TK12X53D	525	12	150	0.58	25	
		2SK3438	600	10	80	1.0	28	
		TK12X60U	600	12	100	0.4	14	
		TK15X60U	600	15	125	0.3	17	
TK20X60U	600	20	150	0.19	27			
 <p>TO-220 (mm)</p>	N-ch Single	TK12E60U	600	12	144	0.4	14	
		TK15E60U	600	15	170	0.3	17	
		TK20E60U	600	20	190	0.19	27	

- Contact the Toshiba sales representative for information about RoHS compliance before you purchase any components.

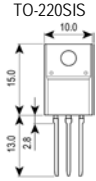

Package	Polarity	Part Number	V <sub>DSS</sub> (V)	I <sub>D</sub> (A)	P <sub>D</sub> (W)	R <sub>DS(ON)</sub> Max (Ω)	Q <sub>g</sub> (nC) (typ.)	Internal Connections
						V <sub>GS</sub> = 10 V		
	N-ch Single	2SK3757	450	2	30	2.45	9	
		2SK3766	450	2	30	2.45	8	
		TK5A45DA	450	4.5	30	1.75	9	
		TK6A45DA	450	5.5	35	1.35	11	
		TK7A45DA	450	6.5	35	1.2	11	
		TK8A45DA	450	7.5	35	1.1	12	
		TK8A45D	450	8	35	0.9	16	
		TK9A45D	450	9	40	0.77	16	
		TK11A45D	450	11	40	0.62	20	
		TK12A45D	450	12	45	0.52	24	
		TK13A45D	450	13	45	0.46	25	
		TK14A45DA	450	13.5	45	0.41	28	
		TK14A45D	450	14	45	0.34	38	
		TK16A45D	450	16	50	0.27	40	
		TK19A45D	450	19	50	0.25	45	
		TK4A50D	500	4	30	2.0	9	
		TK5A50D	500	5	35	1.5	11	
		TK6A50D	500	6	35	1.4	11	
		TK7A50D	500	7	35	1.22	12	
		TK8A50DA	500	7.5	35	1.04	16	
		TK8A50D	500	8	40	0.85	16	
		TK10A50D	500	10	45	0.72	20	
		TK11A50D	500	11	45	0.6	38	
		TK12A50D	500	12	45	0.52	25	
		TK13A50DA	500	12.5	45	0.47	28	
		TK13A50D	500	13	45	0.4	32	
		TK15A50D	500	15	50	0.3	40	
		TK18A50D	500	18	50	0.27	45	
		TK4A53D	525	4	35	1.7	11	
		TK5A53D	525	5	35	1.5	11	
		TK6A53D	525	6	35	1.3	12	
		TK12A53D	525	12	45	0.58	25	
		TK4A55DA	550	3.5	30	2.45	9	
		TK4A55D	550	4	35	1.88	11	
		TK5A55D	550	5	35	1.7	11	
		TK6A55DA	550	5.5	35	1.48	12	
		TK7A55D	550	7	35	1.25	16	
		TK8A55DA	550	7.5	40	1.07	16	
		TK9A55DA	550	8.5	40	0.86	20	
		TK10A55D	550	10	45	0.72	24	
		TK11A55D	550	11	45	0.63	25	
		TK12A55D	550	12	45	0.57	28	
		TK13A55DA	550	12.5	45	0.48	38	
		TK14A55D	550	14	50	0.37	40	
		TK16A55D	550	16	50	0.33	45	
TK3A60DA	600	2.5	30	2.8	9			
TK4A60DA	600	3.5	35	2.2	11			
TK4A60DB	600	3.7	35	2	11			

• Contact the Toshiba sales representative for information about RoHS compliance before you purchase any components.

300 V < V<sub>DSS</sub> ≤ 700 V (Power MOSFETs) (N-ch MOSFETs) (Continued)

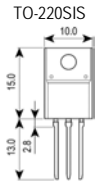
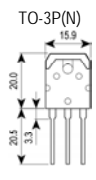
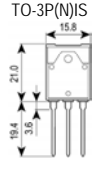
Package	Polarity	Part Number	V <sub>DSS</sub> (V)	I <sub>D</sub> (A)	P <sub>D</sub> (W)	R <sub>DS(ON)</sub> Max (Ω)	Q <sub>g</sub> (nC) (typ.)	Internal Connections
						V <sub>GS</sub> = 10 V		
 <p>TO-220SIS (mm)</p>	N-ch Single	TK4A60D	600	4	35	1.7	12	
		TK5A60D	600	5	35	1.43	16	
		TK6A60D	600	6	40	1.25	16	
		TK8A60DA	600	7.5	45	1.0	20	
		TK9A60D	600	9	45	0.83	24	
		TK10A60D	600	10	45	0.75	25	
		TK11A60D	600	11	45	0.65	28	
		TK12A60D	600	12	45	0.55	38	
		TK12A60U	600	12	35	0.4	14	
		TK13A60D	600	13	40	0.43	40	
		TK15A60D	600	15	50	0.37	45	
		TK15A60U	600	15	40	0.3	17	
		TK18A60V	600	18	40	0.19	39	
		TK20A60U	600	20	45	0.19	27	
		TK2A65D	650	2	30	3.26	9	
		TK3A65DA	650	2.5	35	2.51	11	
		TK3A65D	650	3	35	2.25	11	
		TK4A65DA	650	3.5	35	1.9	12	
		TK5A65DA	650	4.5	35	1.67	16	
		TK5A65D	650	5	40	1.43	16	
		TK6A65D	650	6	45	1.11	20	
		TK7A65D	650	7	45	0.98	24	
		TK8A65D	650	8	45	0.84	25	
		TK11A65D	650	11	45	0.7	38	
TK12A65D	650	12	50	0.54	40			
TK13A65D	650	13	50	0.47	45			
TK13A65U	650	13	40	0.38	17			
TK17A65U	650	17	45	0.26	27			
 <p>TO-3P(N) (mm)</p>	N-ch Single	2SK2601	500	10	125	1.0	30	
		TK15J50D	500	15	210	0.4	32	
		TK20J50D	500	20	280	0.27	45	
		TK12J55D	550	12	190	0.57	28	
		TK16J55D	550	16	250	0.37	40	
		TK19J55D	550	19	280	0.33	45	
		2SK2602	600	6	125	1.25	30	
		2SK2699	600	12	150	0.65	58	
		TK12J60U	600	12	144	0.4	14	
		TK15J60U	600	15	170	0.3	17	
		TK20J60U	600	20	190	0.19	27	
		TK40J60U	600	40	320	0.08	55	
		TK50J60U	600	50	400	0.065	67	
		TK13J65U	650	13	170	0.38	17	
TK17J65U	650	17	190	0.26	27			
 <p>TO-3P(N)IS (mm)</p>	N-ch Single	2SK2917	500	18	90	0.27	80	
		2SK2953	600	15	90	0.4	80	
		TK40M60U	600	40	90	0.08	55	
		2SK3453	700	10	80	1.0	53	

• Contact the Toshiba sales representative for information about RoHS compliance before you purchase any components.

700 V < V<sub>DSS</sub> (Power MOSFETs) (N-ch MOSFETs)

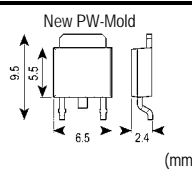
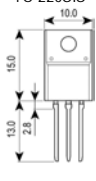
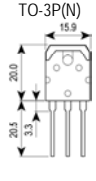
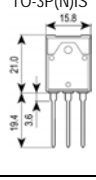
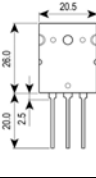
Package	Polarity	Part Number	V <sub>DSS</sub> (V)	I <sub>D</sub> (A)	P <sub>D</sub> (W)	R <sub>DS(ON)</sub> Max (Ω)	Q <sub>g</sub> (nC) (typ.)	Internal Connections
						V <sub>GS</sub> = 10 V		
 (mm)	N-ch Single	TK1P90A	900	1	20	9.0	13	
		TK1Q90A	900	1	20	9.0	13	
 (mm)	N-ch Single	2SK4013	800	6	45	1.7	45	
		2SK3566	900	2.5	40	6.4	12	
		2SK3564	900	3	40	4.3	17	
		2SK3798	900	4	40	3.5	26	
		2SK3565	900	5	45	2.5	28	
		2SK3742	900	5	45	2.5	25	
		2SK4014	900	6	45	2.0	45	
 (mm)	N-ch Single	2SK3799	900	8	50	1.3	62	
		2SK3633	800	7	150	1.7	35	
		2SK2607	800	9	150	1.2	68	
		2SK2719	900	3	125	4.3	25	
		2SK3700	900	5	150	2.5	28	
		2SK4115	900	7	150	2.0	45	
		2SK3473	900	9	150	1.6	38	
		2SK3878	900	9	150	1.3	62	
		2SK2968	900	10	150	1.25	70	
		2SK4207	900	13	150	0.95	45	
 (mm)	N-ch Single	2SK1359	1000	5	125	3.8	60	
		2SK2613	1000	8	150	1.7	65	
		2SK3880	800	6.5	80	1.7	35	
		2SK2606	800	8	85	1.2	68	
		2SK2847	900	8	85	1.4	58	
 (mm)	N-ch Single	2SK3017	900	8.5	90	1.25	70	
		2SK1365	1000	7	90	1.8	120	
		2SK1489	1000	12	200	1.0	110	

• Contact the Toshiba sales representative for information about RoHS compliance before you purchase any components.

$|V_{DSS}| \leq 250$  V (Power MOSFETs) (P-ch MOSFETs)

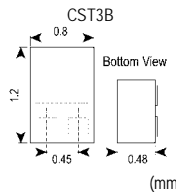
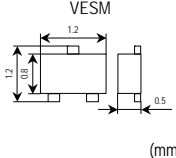
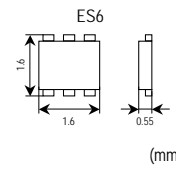
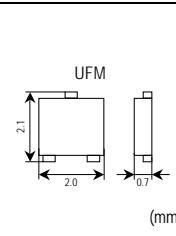
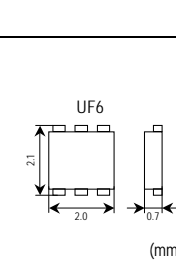
Package	Polarity	Part Number	$V_{DSS}$ (V)	$V_{GSS}$ (V)	$I_D$ (A)	$R_{DS(ON)}$ Max (m $\Omega$ )						$C_{iss}$ (pF)	Internal FET	Internal Connections	
						$V_{GS} = -1.2$ V	$V_{GS} = -1.5$ V	$V_{GS} = -1.8$ V	$V_{GS} = -2.5$ V	$V_{GS} = -4.0$ V	$V_{GS} = -4.5$ V				
	Pch	SSM3J46CTB *	-20	$\pm 8$	-2	—	250	178	133	—	103	290	—	(4)	
		SSM3J56MFV *	-20	$\pm 8$	-0.8	4000	900	660	480	—	390	100	—	(3)	
	Pch	SSM6J212FE *	-20	$\pm 8$	-4.0	—	94	65.4	49	—	40.7	970	—	(2)	
		SSM6J215FE *	-20	$\pm 8$	-3.4	—	154	104	79	—	59	630	—	(2)	
	Pch	SSM6J214FE *	-30	$\pm 12$	-3.6	—	—	149.6	77.6	—	57	560	—	(2)	
		SSM6J213FE *	-20	$\pm 8$	-2.6	—	250	178	133	—	103	290	—	(2)	
		SSM6J207FE	-30	$\pm 20$	-1.4	—	—	—	—	491	—	137	—	(2)	
		Pch + Pch	SSM6P41FE *	-20	$\pm 8$	-0.72	—	1040	670	440	—	300	110	—	(1)
		SSM3J132TU *	-12	$\pm 6$	-5.4	94	39	29	21	—	17	2700	—	(3)	
	Pch	SSM3J130TU *	-20	$\pm 8$	-4.4	—	63.2	41.1	31.0	—	25.8	1800	—	(3)	
		SSM3J129TU *	-20	$\pm 8$	-4.6	—	137	88	62	—	46	640	—	(3)	
		SSM3J113TU	-20	$\pm 12$	-1.7	—	—	449 (@-2.0 V)	249	169	—	370	—	(3)	
		SSM3J133TU *	-20	$\pm 8$	-5.5	—	88.4	56.0	39.7	—	29.8	840	—	(3)	
		SSM3J134TU *	-20	$\pm 8$	-3.2	—	240	168	123	—	93	290	—	(3)	
		SSM3J135TU *	-20	$\pm 8$	-3.0	—	260	180	132	—	103	270	—	(3)	
		SSM3J117TU	-30	$\pm 20$	-2.0	—	—	—	—	225	—	280	—	(3)	
		SSM3J118TU	-30	$\pm 20$	-1.4	—	—	—	—	480	—	137	—	(3)	
		SSM3J112TU	-30	$\pm 20$	-1.1	—	—	—	—	790	—	86	—	(3)	
	Pch	SSM6J409TU *	-20	$\pm 8$	-9.5	—	72.3	46.3	30.2	—	22.1	1100	—	(2)	
		SSM6J412TU *	-20	$\pm 8$	-4.0	—	99.6	67.8	51.4	—	42.7	840	—	(2)	
		SSM6J50TU	-20	$\pm 10$	-2.5	—	—	205 (@-2.0 V)	100	—	64	800	—	(2)	
		SSM6J401TU	-30	$\pm 20$	-2.5	—	—	—	—	145	—	730	—	(2)	
		SSM6J402TU	-30	$\pm 20$	-2.0	—	—	—	—	225	—	280	—	(2)	
		SSM6J410TU *	-30	$\pm 20$	-2.1	—	—	—	—	393	—	120	—	(2)	
	Pch x 2	SSM6P54TU	-20	$\pm 8$	-1.2	—	555	350	228	—	—	331	—	(1)	
		SSM6P39TU	-20	$\pm 8$	-1.5	—	—	430	294	213	—	250	—	(1)	
		SSM6P25TU	-20	$\pm 12$	-0.5	—	—	—	430	260	—	218	SSM6J25FE x 2	(1)	
		SSM6P40TU	-30	$\pm 20$	-1.4	—	—	—	—	403	—	120	—	(1)	

• Contact the Toshiba sales representative for information about RoHS compliance before you purchase any components.

\*: New product

◆ Internal Connections

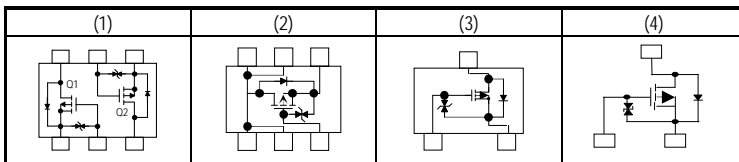

◆ The internal connection diagrams only show the general configurations of the circuits.

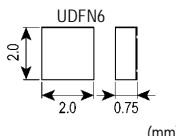
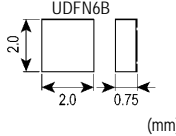
Package	Polarity	Part Number	V <sub>DSS</sub> (V)	V <sub>GSS</sub> (V)	I <sub>D</sub> (A)	R <sub>DS(ON)</sub> Max (mΩ)					C <sub>iss</sub> (pF)	Internal FET	Internal Connections
						V <sub>GS</sub> = -1.2 V	V <sub>GS</sub> = -1.5 V	V <sub>GS</sub> = -1.8 V	V <sub>GS</sub> = -2.5 V	V <sub>GS</sub> = -4.5 V			
 UDFN6 (mm)	Pch x 2	SSM6P47NU *	-20	±8	-4	—	242	170	125	95	290	—	(3)
		SSM6P49NU *	-20	±12	-4	—	—	157	76	56	480	—	(3)
 UDFN6B (mm)	Pch	SSM6J505NU **	-12	±6	-10	70	23	20	15	10	3000	—	(2)
		SSM6J501NU *	-20	±8	-10	—	43	26.5	19	15.3	2600	—	(2)
		SSM6J502NU *	-20	±8	-6	—	60.5	38.4	28.3	23.1	1800	—	(2)
		SSM6J503NU *	-20	±8	-6	—	89.6	57.9	41.7	32.4	840	—	(2)

• Contact the Toshiba sales representative for information about RoHS compliance before you purchase any components.

\*: New product

\*\* : Under development

### ◆Internal Connections

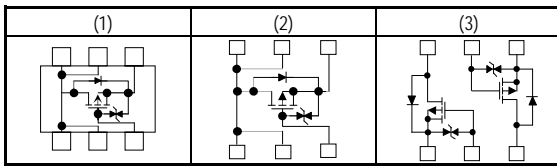

◆The internal connection diagrams only show the general configurations of the circuits.

$|V_{DS}| \leq 250$  V (Power MOSFETs) (P-ch MOSFETs) (Continued)

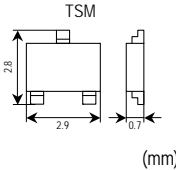
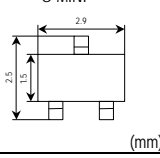
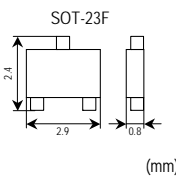
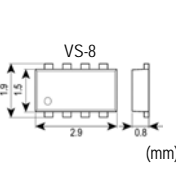
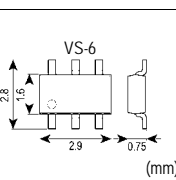
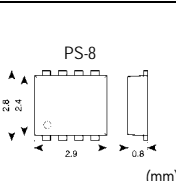
Package	Polarity	Part Number	$V_{DS}$ (V)	$V_{GS}$ (V)	$I_D$ (A)	$P_D$ (W)	$R_{DS(ON)}$ Max ( $m\Omega$ )								$C_{iss}$ (pF)	$Q_g$ (nC) (typ.)	Internal Connections
							$V_{GS} = -1.5V$	$V_{GS} = -1.8V$	$V_{GS} = -2.0V$	$V_{GS} = -2.5V$	$V_{GS} = -4V$	$V_{GS} = -4.5V$	$V_{GS} = -7V$	$V_{GS} = -10V$			
 (mm)	Pch	SSM3J326T *	-30	$\pm 12$	-5.6	1.25	—	115	—	62.5	—	45.7	—	—	650	9.3	(6)
		SSM3J314T	-30	$\pm 20$	-3.5	0.7	—	—	—	—	100	—	—	—	505	11.5	(6)
		SSM3J306T	-30	$\pm 20$	-2.4	0.7	—	—	—	—	225	—	—	—	280	2.5	(6)
		SSM3J305T	-30	$\pm 20$	-1.7	0.7	—	—	—	—	477	—	—	—	137	1.3	(6)
 (mm)	Pch	SSM3J325F *	-20	$\pm 8$	-2	1.2	311	231	—	179	—	150	—	—	270	4.6	(6)
 (mm)	Pch	SSM3J328R *	-20	$\pm 8$	-6	2	88.4	56	—	39.7	—	29.8	—	—	840	12.8	(6)
		SSM3J331R *	-20	$\pm 8$	-4	2	150	100	—	75	—	55	—	—	630	4.7	(6)
		SSM3J327R *	-20	$\pm 8$	-3.9	2	240	168	—	123	—	93	—	—	290	4.6	(6)
		SSM3J332R *	-30	$\pm 12$	-6	2	—	144	—	72	—	50	—	47	560	8.2	(6)
		SSM3J334R *	-30	$\pm 20$	-4	2	—	—	—	—	—	105	—	71	280	5.9	(6)
 (mm)	Pch Single	TPCF8101	-12	$\pm 8$	-6	2.5	—	85	—	40	—	28	—	—	18	(2)	
		TPCF8103	-20	$\pm 8$	-2.7	2.5	—	300	—	160	—	110	—	—	—	6	(2)
		TPCF8105	-20	$\pm 12$	-6	2.5	—	100	—	41	—	30	—	—	—	17	(2)
		TPCF8108	-20	$\pm 12$	-7	2.5	—	95	—	37	—	26	—	—	1320	19	(2)
	Pch Dual	TPCF8107	-30	-25/+20	-6	2.5	—	—	—	—	—	38	—	28	970	22	(2)
		TPCF8301	-20	$\pm 8$	-2.7	1.35	—	300	—	160	—	110	—	—	—	6	(3)
		TPCF8305	-20	$\pm 12$	-4	1.35	—	265	160	83	—	58	—	—	680	9.2	(3)
TPCF8304	-30	$\pm 20$	-3.2	1.35	—	—	—	—	—	105	—	72	—	14	(3)		
 (mm)	Pch Single	TPC6130	-20	$\pm 12$	-2.8	2.2	—	—	—	164	—	106	—	—	360	5.1	(1)
		TPC6103	-12	$\pm 8$	-5.5	2.2	—	90	—	55	—	35	—	—	—	20	(1)
		TPC6105	-20	$\pm 8$	-2.7	2.2	—	300	—	160	—	110	—	—	—	6	(1)
		TPC6113	-20	$\pm 12$	-5	2.2	—	—	—	85	—	55	—	—	690	10	(1)
		TPC6111	-20	$\pm 8$	-5.5	2.2	—	80	—	57	—	40	—	—	—	10	(1)
		TPC6110	-30	-25/+20	-4.5	2.2	—	—	—	—	—	77	—	56	—	14	(1)
 (mm)	Pch Single	TPCP8101	-20	$\pm 8$	-5.6	1.68	—	90	—	41	—	30	—	—	19	(4)	
		TPCP8105	-20	$\pm 12$	-5.2	1.68	—	60	45	23	—	17	—	—	2280	28	(4)
		TPCP8102	-20	$\pm 12$	-7.2	1.68	—	—	80	30	—	18	—	—	—	33	(4)
		TPCP8106	-30	-25/+20	-7.2	1.68	—	—	—	—	—	44	—	33	870	19	(4)
		TPCP8103-H	-40	$\pm 20$	-4.8	1.68	—	—	—	—	—	54	—	40	—	19	(4)
	Pch Dual	TPCP8303	-20	$\pm 8$	-3.8	1.48	144	90	—	60	—	46	—	—	—	10	(3)
		TPCP8306	-20	$\pm 12$	-4	1.48	—	265	160	83	—	58	—	—	680	9.2	(3)
		TPCP8305	-20	$\pm 12$	-6	1.48	—	—	—	42	—	30	—	—	1500	21.5	(3)

• Contact the Toshiba sales representative for information about RoHS compliance before you purchase any components.

\*: New product

◆ Internal Connections

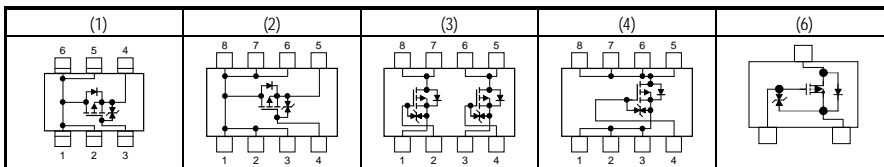

Note: Some MOSFETs do not have a Zener diode between gate and source.

◆ The internal connection diagrams only show the general configurations of the circuits.

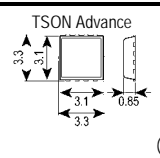
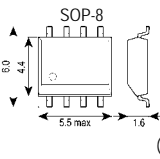
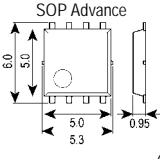
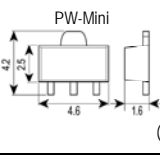
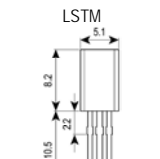
Package	Polarity	Part Number	V <sub>DSS</sub> (V)	V <sub>GSS</sub> (V)	I <sub>D</sub> (A)	P <sub>D</sub> (W)	R <sub>DS(ON)</sub> Max (mΩ)							Q <sub>g</sub> (nC) (typ.)	Internal Connections
							V <sub>GS</sub> = -1.8 V	V <sub>GS</sub> = -2.0 V	V <sub>GS</sub> = -2.5 V	V <sub>GS</sub> = -4 V	V <sub>GS</sub> = -4.5 V	V <sub>GS</sub> = -7 V	V <sub>GS</sub> = -10 V		
 TSON Advance (mm)	Pch Single	TPCC8131	-30	-25/+20	-10	20	—	—	—	—	23	—	17.6	40	(1)
		TPCC8102	-30	±20	-15	26	—	—	—	33.2	—	—	18.9	26	(1)
		TPCC8103	-30	±20	-18	27	—	—	—	25	—	—	12	38	(1)
		TPCC8104	-30	-25/+20	-20	27	—	—	—	—	12.4	—	8.8	58	(1)
		TPCC8105	-30	-25/+20	-23	30	—	—	—	—	10.4	—	7.8	76	(1)
 SOP-8 (mm)	Pch Single	TPC8129	-30	-25/+20	-9	1.9	—	—	—	—	22	—	28	39	(1)
		TPC8119	-30	±20	-10	1.9	—	—	—	28	—	—	13	40	(1)
		TPC8125	-30	-25/+20	-10	1.9	—	—	—	—	17	—	13	64	(1)
		TPC8121	-30	±20	-10	1.9	—	—	—	24	—	—	12	42	(1)
		TPC8126	-30	-25/+20	-11	1.9	—	—	—	—	14	—	10	56	(1)
		TPC8123	-30	-25/+20	-11	1.9	—	—	—	—	12.5	—	9	68	(1)
		TPC8122	-30	±20	-12	1.9	—	—	—	16.5	—	—	8	62	(1)
		TPC8118	-30	±20	-13	1.9	—	—	—	15	—	—	7	65	(1)
		TPC8127	-30	-25/+20	-13	1.9	—	—	—	—	8.9	—	6.5	92	(1)
		TPC8128	-30	-25/+20	-16	1.9	—	—	—	—	6.9	—	5	115	(1)
		TPC8117	-30	±20	-18	1.9	—	—	—	7.9	—	—	3.9	130	(1)
		TPC8120	-30	-25/+20	-18	1.9	—	—	—	—	4.2	—	3.2	180	(1)
		TPC8134	-40	-25/+20	-5	1.9	—	—	—	—	66	—	52	20	(1)
		TPC8132	-40	-25/+20	-7	1.9	—	—	—	—	33	—	25	34	(1)
		TPC8133	-40	-25/+20	-9	1.9	—	—	—	—	18	—	15	64	(1)
TPC8124	-40	-25/+20	-12	1.9	—	—	—	—	10	—	8	104	(1)		
 SOP Advance (mm)	Pch Single	TPCA8105	-12	±8	-6	20	92	—	51	—	33	—	—	18	(1)
		TPCA8109	-30	-25/+20	-12	30	—	—	—	—	13	—	9	56	(1)
		TPCA8128	-30	-25/+20	-34	45	—	—	—	—	6.7	—	4.8	115	(1)
		TPCA8106	-30	±20	-40	45	—	—	—	7.8	—	—	3.7	130	(1)
		TPCA8120	-30	-25/+20	-45	45	—	—	—	—	4.0	—	3.0	190	(1)
		TPCA8107-H	-40	±20	-7.5	30	—	—	—	—	37	—	30	27	(1)
		TPCA8108	-40	±20	-40	45	—	—	—	—	—	—	9.5	100	(1)
TPCA8104	-60	±20	-40	45	—	—	—	—	24	—	16	90	(1)		
 PW-Mini (mm)	Pch Single	2SJ360	-60	—	-1	1.5	—	—	—	1200	—	—	730	6.5	
		2SJ508	-100	—	-1	1.5	—	—	—	2500	—	—	1900	6.3	
 LSTM (mm)	Pch Single	2SJ537	-50	—	-5	0.9	—	—	—	340	—	—	190	18	
		2SJ507	-60	—	-1	0.9	—	—	—	1000	—	—	700	5.6	
		2SJ509	-100	—	-1	0.9	—	—	—	2500	—	—	1900	6.3	

• Contact the Toshiba sales representative for information about RoHS compliance before you purchase any components.

### ◆Internal Connections

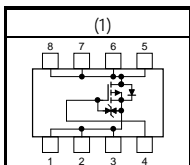

Note: Some MOSFETs do not have a Zener diode between gate and source.

◆The internal connection diagrams only show the general configurations of the circuits.

$|V_{DS}| \leq 250$  V (Power MOSFETs) (P-ch MOSFETs) (Continued)

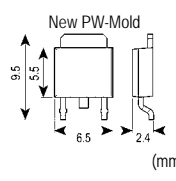
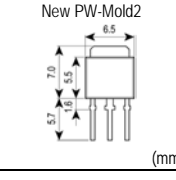
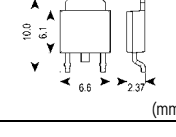
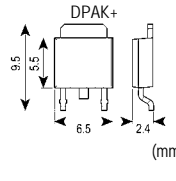
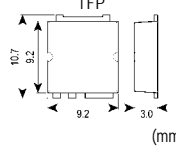
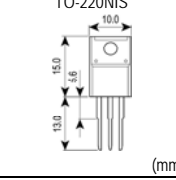
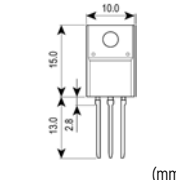
Package	Polarity	Part Number	V <sub>DS</sub> (V)	V <sub>GS</sub> (V)	I <sub>D</sub> (A)	P <sub>D</sub> (W)	R <sub>DS(ON)</sub> Max (mΩ)							Q <sub>g</sub> (nC) (typ.)	Internal Connections		
							V <sub>GS</sub> = -1.8 V	V <sub>GS</sub> = -2.0 V	V <sub>GS</sub> = -2.5 V	V <sub>GS</sub> = -4 V	V <sub>GS</sub> = -4.5 V	V <sub>GS</sub> = -6 V	V <sub>GS</sub> = -7 V			V <sub>GS</sub> = -10 V	
 <p>New PW-Mold (mm)</p>	Pch Single	2SJ439	-16	—	-5	20	—	—	280	200	—	—	—	—	24		
		2SJ668	-60	±20	-5	20	—	—	—	250	—	—	—	170	15		
		2SJ338	-180	—	-1	20	—	—	—	—	—	—	—	5000	—		
		2SJ567	-200	—	-2.5	20	—	—	—	—	—	—	—	2000	10		
		2SJ610	-250	—	-2	20	—	—	—	—	—	—	—	2550	24		
 <p>New PW-Mold2 (mm)</p>	Pch Single	2SJ681	-60	—	-5	20	—	—	—	250	—	—	—	170	15		
		2SJ680	-200	—	-2.5	20	—	—	—	—	—	—	—	2000	10		
 <p>DPAK (mm)</p>	Pch Single	TJ15P04M3	-40	±20	15	29	—	—	—	—	48	—	—	36	26		
 <p>DPAK+ (mm)</p>	Pch Single	TJ10S04K3L	-40	+10/-20	-10	27	—	—	—	—	—	62	—	44	19		
		TJ20S04K3L	-40	+10/-20	-20	41	—	—	—	—	—	—	32	—	22.2	37	
		TJ40S04K3L	-40	+10/-20	-40	68	—	—	—	—	—	—	13	—	9.1	83	
		TJ60S04K3L	-40	+10/-20	-60	90	—	—	—	—	—	—	9.4	—	6.3	125	
		TJ80S04K3L	-40	+10/-20	-80	100	—	—	—	—	—	—	7.9	—	5.2	158	
		TJ8S06K3L	-60	+10/-20	-8	27	—	—	—	—	—	—	130	—	104	19	
		TJ15S06K3L	-60	+10/-20	-15	41	—	—	—	—	—	—	63	—	50	36	
		TJ30S06K3L	-60	+10/-20	-30	68	—	—	—	—	—	—	28	—	21.8	80	
		TJ50S06K3L	-60	+10/-20	-50	90	—	—	—	—	—	—	17.4	—	13.8	124	
 <p>TFP (mm)</p>	Pch Single	TJ80X04M3L	-40	+10/-20	-80	150	—	—	—	—	—	5.9	—	3.9	250		
		TJ80X06M3L	-60	+10/-20	-80	150	—	—	—	—	—	—	11.4	—	7.6	250	
		2SJ619	-100	—	-16	75	—	—	—	320	—	—	—	—	210	48	
		2SJ620	-100	—	-18	125	—	—	—	120	—	—	—	—	90	140	
 <p>TO-220NIS (mm)</p>	Pch Single	2SJ438	-60	—	-5	25	—	—	—	280	—	—	—	190	22		
		2SJ313	-180	—	-1	25	—	—	—	—	—	—	—	—	5000	—	
 <p>TO-220SIS (mm)</p>	Pch Single	TJ70A06J3	-60	—	-70	54	—	—	—	—	10	—	—	8	246		
		TJ9A10M3	-100	±20	-9	19	—	—	—	—	—	—	—	—	170	47	
		TJ11A10M3	-100	±20	-11	24	—	—	—	—	—	—	—	—	130	69	
		TJ20A10M3	-100	±20	-20	35	—	—	—	—	—	—	—	—	90	120	

• Contact the Toshiba sales representative for information about RoHS compliance before you purchase any components.

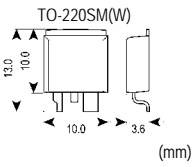
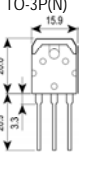
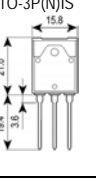
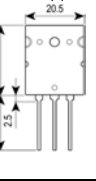

Package	Polarity	Part Number	V <sub>DSS</sub> (V)	I <sub>D</sub> (A)	P <sub>D</sub> (W)	R <sub>DS(ON)</sub> Max (mΩ)								Q <sub>g</sub> (nC) (typ.)	Internal Connections
						V <sub>GS</sub> = -1.8 V	V <sub>GS</sub> = -2.0 V	V <sub>GS</sub> = -2.5 V	V <sub>GS</sub> = -4 V	V <sub>GS</sub> = -4.5 V	V <sub>GS</sub> = -6 V	V <sub>GS</sub> = -7 V	V <sub>GS</sub> = -10 V		
 <p>TO-220SM(W) (mm)</p>	Pch Single	TJ100F04M3L	-40	-100	250	—	—	—	—	—	5.4	—	3.6	250	
		TJ150F04M3L	-40	-150	300	—	—	—	—	—	4.2	—	2.8	390	
		TJ100F06M3L	-60	-100	250	—	—	—	—	—	10.7	—	7.1	250	
		TJ120F06J3	-60	-120	300	—	—	—	—	—	—	—	8	258	
		TJ150F06M3L	-60	-150	300	—	—	—	—	—	6.1	—	5.6	420	
 <p>TO-3P(N) (mm)</p>	Pch Single	2SJ200	-180	-10	120	—	—	—	—	—	—	—	830	—	
		2SJ618	-180	-10	130	—	—	—	—	—	—	370	—	35	
 <p>TO-3P(N)IS (mm)</p>	Pch Single	2SJ440	-180	-9	80	—	—	—	—	—	—	—	830	—	
 <p>TO-3P(L) (mm)</p>	Pch Single	2SJ201	-200	-12	150	—	—	—	—	—	—	—	625	—	

• Contact the Toshiba sales representative for information about RoHS compliance before you purchase any components.

$|V_{DS}| \leq 60 \text{ V}$  (Power MOSFETs) (Complementary MOSFETs)

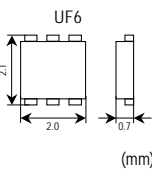
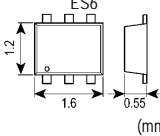
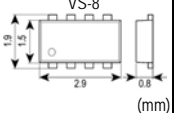
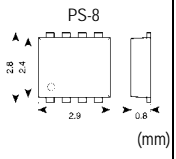
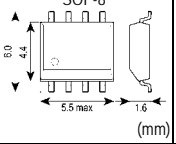
Package	Polarity	Part Number	V <sub>bss</sub> (V)	V <sub>gss</sub> (V)	I <sub>d</sub> (A)	R <sub>DS(ON)</sub> Max (mΩ)						C <sub>iss</sub> (pF)	Q <sub>g</sub> (nC) (typ.)	Internal FET	Internal Connections
						V <sub>gs</sub>   = 1.5 V	V <sub>gs</sub>   = 1.8 V	V <sub>gs</sub>   = 2.5 V	V <sub>gs</sub>   = 4.0 V	V <sub>gs</sub>   = 4.5 V	V <sub>gs</sub>   = 10 V				
 UF6 (mm)	N-ch + P-ch	SSM6L39TU	20	±10	1.6	247	190	139	119	—	—	265	SSM6N39TU + SSM6P39TU	(1)	
			-20	±8	-1.5	—	430	294	213	—	—	250			
		SSM6L12TU	30	±12	0.5	—	—	180	145	—	—	245	SSM6K24FE + SSM6J25FE	(1)	
			-20	±12	-0.5	—	—	430	260	—	—	218			
		SSM6L40TU	30	±20	1.6	—	—	—	182	—	—	180	SSM6N40TU + SSM6P40TU	(1)	
			-30	±20	-1.4	—	—	—	403	—	—	120			
SSM6E03TU	20	±10	0.1	15 Ω	—	4.0 Ω	3.0 Ω	—	—	9.3	SSM3K16FU	(3)			
	-20	±8	-1.8	—	335	180	144	—	—	335					
SSM6E02TU	20	±10	0.1	15 Ω	—	4.0 Ω	3.0 Ω	—	—	9.3	SSM3K16FU	(3)			
	-20	±8	-1.8	364	204	136	—	—	—	568					
SSM6E01TU	20	±10	0.05	—	—	10 Ω	—	—	—	11	SSM3K04FE	(2)			
	-12	±12	-1	—	—	240	160	—	—	310					
 ES6 (mm)	N-ch + P-ch	SSM6L14FE *	20	±10	0.8	600	450	330	—	240	—	90	2.0	SSM6N42FE	(1)
			-20	±8	-0.72	1040	670	440	—	300	—	110	1.76	SSM6P41FE	(1)
 VS-8 (mm)	N-ch + P-ch	TPCP8402	30	±20	4	—	—	—	77	—	50	—	10	—	(4)
			-30	±20	-3.2	—	—	—	105	—	72	—	14	—	(4)
 PS-8 (mm)	N-ch + P-ch	TPCP8404	30	±20	4	—	—	—	—	80	50	—	4.6	—	(4)
			-30	±20	-4	—	—	—	—	80	50	—	13	—	(4)
		TPCP8403	40	±20	4.7	—	—	—	—	60	40	—	16	—	(4)
			-40	±20	-3.4	—	—	—	—	105	70	—	15	—	(4)
TPCP8405	30	±20	6.5	—	—	—	—	29	26	—	13.8	—	(4)		
	-30	±20	-6	—	—	—	—	42	31.3	—	24.1	—	(4)		
TPCP8406	40	±20	6	—	—	—	—	36	32	—	13.7	—	(4)		
	-40	±20	-5	—	—	—	—	53.4	43.2	—	24.2	—	(4)		
 SOP-8 (mm)	N-ch + P-ch	TPCP8407	30	±20	9	—	—	—	—	21	17	1190	17	—	(4)
			-30	±20	-7.4	—	—	—	—	23	29	1650	39	—	(4)
		TPCP8408	40	±20	6.1	—	—	—	—	43.2	32	850	14	—	(4)
			-40	±20	-5.3	—	—	—	—	53.4	36	1105	24	—	(4)

• Contact the Toshiba sales representative for information about RoHS compliance before you purchase any components.

\*: New product

◆ Internal Connections

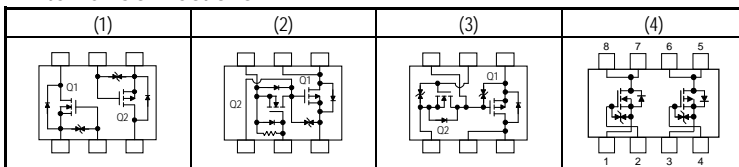

Note: Some MOSFETs do not have a Zener diode between gate and source.

◆ The internal connection diagrams only show the general configurations of the circuits.

(Load SW)

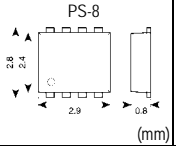
Package	Polarity	Part Number	V <sub>DSS</sub> (V)	V <sub>GSS</sub> (V)	I <sub>D</sub> (A)	P <sub>D</sub> (W)	R <sub>DS(ON)</sub> Max (mΩ)								C <sub>iss</sub> (pF)	Q <sub>g</sub> (nC) (typ.)	Internal Connections
							V <sub>GS</sub>   = 1.5 V	V <sub>GS</sub>   = 1.8 V	V <sub>GS</sub>   = 2.0 V	V <sub>GS</sub>   = 2.5 V	V <sub>GS</sub>   = 4V	V <sub>GS</sub>   = 4.5 V	V <sub>GS</sub>   = 7V	V <sub>GS</sub>   = 10 V			
 PS-8 (mm)	Load SW	TPCP8401	-12	±8	-5.5	1.96	—	103	—	58	—	38	—	—	—	20	(1)

- Contact the Toshiba sales representative for information about RoHS compliance before you purchase any components.

(MOSFET + BipTr)

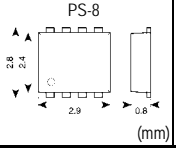
Package	Polarity	Part Number	V <sub>DSS</sub> (V)	V <sub>GSS</sub> (V)	I <sub>D</sub> (A)	P <sub>D</sub> (W)	R <sub>DS(ON)</sub> Max (mΩ)								C <sub>iss</sub> (pF)	Q <sub>g</sub> (nC) (typ.)	Internal Connections
							V <sub>GS</sub> = -1.5 V	V <sub>GS</sub> = -1.8 V	V <sub>GS</sub> = -2.0 V	V <sub>GS</sub> = -2.5 V	V <sub>GS</sub> = -4V	V <sub>GS</sub> = -4.5 V	V <sub>GS</sub> = -7V	V <sub>GS</sub> = -10 V			
 PS-8 (mm)	P-ch + BipTr	TPCP8J01	-32	±20	-5.5	2.14	—	—	—	—	49	—	—	35	—	34	(2)

- Contact the Toshiba sales representative for information about RoHS compliance before you purchase any components.

◆ Internal Connections

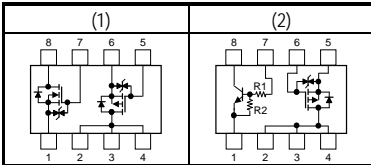

Note: Some MOSFETs do not have a Zener diode between gate and source.

- ◆ The internal connection diagrams only show the general configurations of the circuits.

(MOSFET + SBD)

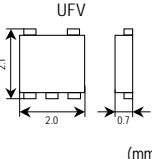
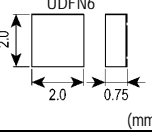
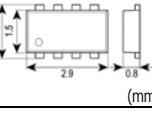
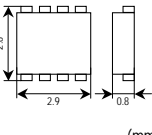
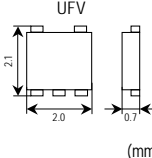
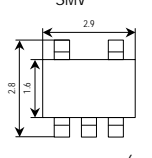
Package	Polarity	Part Number	MOSFET										SBD				Qg (nC) (typ.)	Internal Connections				
			V <sub>DSS</sub> (V)	V <sub>GSS</sub> (V)	I <sub>D</sub> (A)	P <sub>D</sub> (W)	R <sub>DS(on)</sub> Max (mΩ)						C <sub>iss</sub> (pF)	V <sub>R</sub> (V)	I <sub>O</sub> (A)	V <sub>F</sub> Max (V)						
							V <sub>GS</sub>  =1.8 V	V <sub>GS</sub>  =2.0 V	V <sub>GS</sub>  =2.5 V	V <sub>GS</sub>  =4.0 V	V <sub>GS</sub>  =4.5 V	V <sub>GS</sub>  =10 V				I <sub>F</sub> = 1.0 A			I <sub>F</sub> = 0.5 A	I <sub>F</sub> = 0.3 A	I <sub>F</sub> = 0.1 A	
 (mm)	Pch + SBD	SSM5G10TU	-20	±8	-1.5	—	430	—	294	213	—	—	250	20	0.7	—	0.39	—	—	—	—	(1)
		SSM5G09TU	-12	±8	-1.5	—	—	—	200	130	—	—	550	12	0.5	—	0.43	0.39	—	—	—	(1)
		SSM5G02TU	-12	±12	-1	—	—	—	240	160	—	—	310	12	0.5	—	0.43	0.39	—	—	—	(1)
		SSM5G11TU	-30	±20	-1.4	—	—	—	—	403	—	226	120	30	0.7	—	0.41	—	—	—	—	(1)
 (mm)	Pch + SBD	SSM6G18NU *	-20	±8	-2	2	194	—	152	—	122	—	270	30	1	0.58	0.45	—	—	3.6	(5)	
 (mm)		TPCF8B01	-20	±8	-2.7	1.35	300	—	160	—	110	—	20	1	0.49	—	—	—	6	(4)		
 (mm)		TPCP8BA1	-20	±12	-1.3	—	—	—	260	180	—	—	370	25	0.7	—	0.41	—	—	—	(2)	
 (mm)		Nch + SBD	SSM5H10TU	20	±10	1.6	—	190	—	139	119	—	—	260	20	0.7	—	0.39	—	—	—	(3)
	SSM5H08TU		20	±12	1.5	—	—	—	220	160	—	—	125	20	0.5	—	—	0.45	—	—	(3)	
	SSM5H11TU		30	±20	1.6	—	—	—	—	182	—	122	180	30	0.7	—	0.41	—	—	—	(3)	
	SSM5H16TU		30	±12	1.9	—	296	—	177	133	—	—	123	30	0.8	—	0.45	—	0.36	—	(3)	
	SSM5H01TU		30	±20	1.4	—	—	—	—	450	—	200	106	20	0.5	—	—	0.45	—	—	(3)	
	SSM5H07TU		20	±20	1.2	—	—	—	—	540	—	300	36	12	0.5	—	0.43	0.39	—	—	(3)	
 (mm)	Nch + SBD	SSM5H14F	30	±12	3	—	138	—	94	78	—	—	270	45	0.1	—	—	—	0.6	—	(3)	

• Contact the Toshiba sales representative for information about RoHS compliance before you purchase any components.

\*: New product

◆Internal Connections

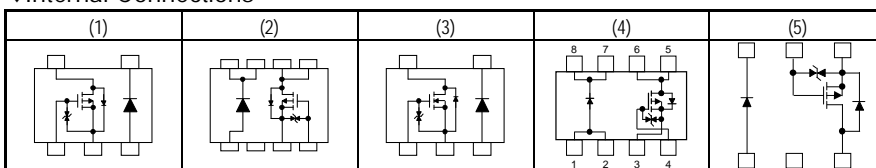

Note: Some MOSFETs do not have a Zener diode between gate and source.

◆The internal connection diagrams only show the general configurations of the circuits.

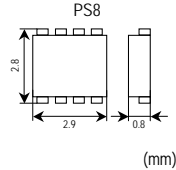
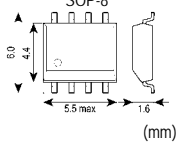
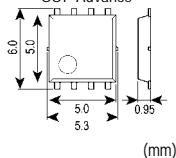
Package	Polarity	Part Number	MOSFET										SBD				Qg (nC) (typ.)	Internal Connections						
			V <sub>DSS</sub> (V)	V <sub>GSS</sub> (V)	I <sub>D</sub> (A)	P <sub>D</sub> (W)	R <sub>DS(ON)</sub> Max (mΩ)						C <sub>iss</sub> (pF)	V <sub>R</sub> (V)	I <sub>O</sub> (A)	V <sub>F</sub> Max (V)								
							V <sub>Gs</sub>   = 1.8V	V <sub>Gs</sub>   = 2.0V	V <sub>Gs</sub>   = 2.5V	V <sub>Gs</sub>   = 4.0V	V <sub>Gs</sub>   = 4.5V	V <sub>Gs</sub>   = 10V				I <sub>F</sub> = 1.0A			I <sub>F</sub> = 0.5A	I <sub>F</sub> = 0.3A	I <sub>F</sub> = 0.1A			
 (mm)	N-ch + SBD	TPCP8AA1	20	±12	1.6	—	—	—	140	105	—	—	306	25	0.7	—	0.41	—	—	—	—	(2)		
		TPCP8A05-H ◇	30	±20	8	1.68	—	—	—	—	21.9	17.5	1300	—	—	—	—	—	—	—	—	16	(1)	
 (mm)		TPC8A05-H ◇	30	±20	10	1.9	—	—	—	—	17.6	13.3	—	—	—	—	—	—	—	—	—	15	(1)	
		TPC8A06-H ◇	30	±20	12	1.9	—	—	—	—	12.9	10.1	1400	—	—	—	—	—	—	—	—	—	19	(1)
		TPC8A03-H ◇	30	±20	17	1.9	—	—	—	—	7	5.6	—	—	—	—	—	—	—	—	—	—	36	(1)
 (mm)		TPC8A04-H ◇	30	±20	18	1.9	—	—	—	—	4.5	3.6	—	—	—	—	—	—	—	—	—	—	56	(1)
		TPCA8A05-H ◇	30	±20	20	30	—	—	—	—	17.2	12.9	—	—	—	—	—	—	—	—	—	—	15	(1)
		TPCA8A02-H ◇	30	±20	34	45	—	—	—	—	6.7	5.3	—	—	—	—	—	—	—	—	—	—	36	(1)
		TPCA8A08-H ◇	30	±20	38	45	—	—	—	—	5.3	4.2	3500	—	—	—	—	—	—	—	—	—	48	(1)
		TPCA8A04-H ◇	30	±20	44	45	—	—	—	—	4.1	3.2	—	—	—	—	—	—	—	—	—	—	59	(1)

◇: Monolithic

- Contact the Toshiba sales representative for information about RoHS compliance before you purchase any components.

### ◆Internal Connections

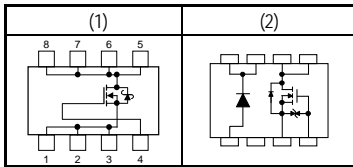

◆The internal connection diagrams only show the general configurations of the circuits.

(MOSFET + Switching Diodes)

Package	Polarity	Part Number	MOSFET										Di						Qg (nC) (typ.)	Internal Connections	
			V <sub>DSS</sub> (V)	V <sub>GSS</sub> (V)	I <sub>D</sub> (A)	P <sub>D</sub> (W)	R <sub>DS(ON)</sub> Max (mΩ)						C <sub>iss</sub> (pF)	V <sub>R</sub> (V)	I <sub>O</sub> (A)	t <sub>rr</sub> (ns)	V <sub>F</sub> Max (V)				
							V <sub>GS</sub> = 1.5 V	V <sub>GS</sub> = 1.8 V	V <sub>GS</sub> = 2.5 V	V <sub>GS</sub> = 4.0 V	V <sub>GS</sub> = 4.5 V	V <sub>GS</sub> = 10 V					I <sub>F</sub> = 1 mA	I <sub>F</sub> = 10 mA			I <sub>F</sub> = 0.1 A
 UFB (mm)	N-ch + Switching diodes	SSM5H90TU	20	±10	2.4	—	157	110	80	65	—	—	400	80	0.1	1.6	—	—	1.2	—	(1)

• Contact the Toshiba sales representative for information about RoHS compliance before you purchase any components.

(MOSFET + Zener Diodes)

Package	Polarity	Part Number	MOSFET										Ze-Di						Qg (nC) (typ.)	Internal Connections		
			V <sub>DSS</sub> (V)	V <sub>GSS</sub> (V)	I <sub>D</sub> (A)	P <sub>D</sub> (W)	R <sub>DS(ON)</sub> Max (mΩ)						C <sub>iss</sub> (pF)	V <sub>Z</sub> (V)	I <sub>R</sub> (μA)	V <sub>F</sub> Max (V)						
							V <sub>GS</sub> = 1.8 V	V <sub>GS</sub> = 2.0 V	V <sub>GS</sub> = 2.5 V	V <sub>GS</sub> = 4.0 V	V <sub>GS</sub> = 4.5 V	V <sub>GS</sub> = 10 V		@I <sub>Z</sub> (mA)	@V <sub>R</sub> (V)	I <sub>F</sub> = 1.0 A	I <sub>F</sub> = 0.5 A	I <sub>F</sub> = 0.3 A				
 PS8 (mm)	N-ch + Zener diodes	TPCP8R01	60	±20	2.0	—	—	—	—	440	—	300	140	43	2	0.5	33	—	—	—	—	(2)

• Contact the Toshiba sales representative for information about RoHS compliance before you purchase any components.

◆ Internal Connections

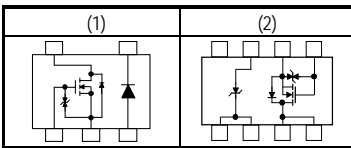

◆ The internal connection diagrams only show the general configurations of the circuits.

# Bipolar Power Transistors

## Radio-Frequency Switching Power Transistors (2SA/2SC/TTA/TTC Series)

V <sub>CEO</sub> (V)	I <sub>C</sub> (A)	10/(15)	(18)/20	(25)/30	40/(45)	50/(60)
0.2					2SA1483 (45 V)	(◎)
0.8				2SA1426 2SA1204	2SC2884	(\$) (◎)
1	TPC6D02 (15 V)	(&)(Δ)		HN4B101J (NPN: 1.2 A)	(M)(V)	2SA2070 (◎) TPC6701 (W)(Δ) 2SC5810 (◎) TPC6901A (M)(Δ) (PNP: 0.7 A) TPCP8901 (M)(P) (PNP: 0.8 A) TTA007 * TTC007 * (♣) TPC6604 * TPC6504 * (Δ)
1.2			TPC6D03 (&)(Δ)	2SA1734 TPCP8801	(◎) (W)(P)	
1.5	2SA2058 (♣)	2SA2065 (♣) 2SA2069 (◎) 2SC5784 (♣) 2SC5819 (◎) TPC6503 (Δ) S3F56 ++ (Δ)		2SA966 (♣) 2SA1203 (◎)	2SC2236 (♣)	
2	2SA1160 (♣) 2SA1430 (S) 2SA2066 (◎) 2SC5755 (♣) 2SC5785 (◎) TPC6501 (Δ) TPC6602 (Δ) TPCP8504 (P)			TPCP8902 (M)(P) (NPN+PNP) TPC6902 (M)(Δ) (NPN+PNP) : PNP-1.7A HN4B102J (M)(V) (NPN+PNP)	2SC3673 (S)	2SA1020 (♣) 2SA1241 (◇) 2SC3076 (◇) 2SA1382 (♣) 2SA2056 (♣) TPC6601 (Δ) TPCP8701 (W)(P) 2SA2060 (◎) 2SA1428 (S) 2SC3668 (S) 2SA1680 (♣) 2SC2655 (♣) 2SC408 (♣)
2.5			2SA2061 (♣)			2SC5692 (♣) 2SC6033 (♣) TPCP8602 (P)
3	2SC4682 (15 V) (♣) 2SC4683 (15 V) (S)	2SA2059 (◎) TPCP8F01 (S)(P) TPC6603 (Δ) TPCP8G01 * (S)(P)		2SC5976 (♣) TPCP8H02 (S)(P)	2SC3422 (@)	2SA1761 (♣) 2SA1869 (♣) 2SC4604 (♣) 2SC4935 (♣) 2SC5712 (◎) TPC6502 (Δ) TPCP8505 (P) 2SC6126 (◎) TPCP8511 * (P)
3.5			2SC5738 (♣)			

- The products shown in bold are also manufactured in offshore fabs.
- Contact the Toshiba sales representative for information about RoHS compliance before you purchase any components.

\*: New product  
++: Being planned

### Legend

Package		Surface-Mount Package	Other Remarks
Through-Hole Package	Ammo Packaging		
(♣) LSTM	○	(♣) TSM	(%) Darlington
(S) MSTM	○	(◎) PW-Mini	(#) Built-in zener diode
(@) TO-126	×	(◇) PW-Mold	Part number in italic signifies built in Freewheel diode.
(▲) TO-220NIS	×	(Δ) VS-6	2SA****/2SC****: Complementary
(◇) PW-Mold	×	(P) PS-8	(&) 2-in-1 (transistor + diode)
(▽) TO-3P(N)	×	(V) SMV	(S) 2-in-1 (transistor + S-MOS)
(▼) TO-3P(N)IS	×	(♥) TFP	(W) 2-in-1 (NPN (or PNP) × 2)
(※) TO-3P(L)	×		(M) 2-in-1 (NPN + PNP)

V <sub>CEO</sub> (V) I <sub>C</sub> (A)	10/(15)	(18)/20	(25)/30	40/(45)	50/(60)
4	2SC5713 (⊙) S3F61 ++ (Δ)	2SC5714 (⊙) 2SC6125 (⊙) S3F62 ++ (Δ) TPCP8601 (P)	2SC5906 (▲)		2SC5703 (▲)
5		2SA1242 (◇) 2SA1431 (S) 2SC3072 (◇) 2SC3671 (S) 2SC6052 (◇)	2SC6062 (▲)		2SA1244 2SC3074 (◇) 2SA1931 2SC4881 (▲) 2SA2097 (◇) 2SC5886 (◇) 2SC5886A (◇) TPCP8H01 (S)(P) S3H32 ++ (◇)
7					2SC6000 (◇)

• Contact the Toshiba sales representative for information about RoHS compliance before you purchase any components.

++: Being planned

### Legend

Package			Other Remarks
Through-Hole Package	Ammo Packaging	Surface-Mount Package	
(▲) LSTM	○	(▲) TSM	(%) Darlington
(S) MSTM	○	(⊙) PW-Mini	(#) Built-in zener diode
(@) TO-126	×	(◇) PW-Mold	Part number in italic signifies built in Freewheel diode.
(▲) TO-220NIS	×	(Δ) VS-6	2SA****/2SC****: Complementary
(◇) PW-Mold	×	(P) PS-8	(&) 2-in-1 (transistor + diode)
(▽) TO-3P(N)	×	(V) SMV	(S) 2-in-1 (transistor + S-MOS)
(▼) TO-3P(N)IS	×	(♥) TFP	(W) 2-in-1 (NPN (or PNP) × 2)
(※) TO-3P(L)	×		(M) 2-in-1 (NPN + PNP)



Radio-Frequency Switching Power Transistors (2SA/2SC/TTA/TTC Series) (Continued)

V <sub>CEO</sub> (V)	80		100		120		(140)/150		160	
I <sub>C</sub> (A)										
0.05							<b>2SA1145</b>		(♣)	
							2SA1360	2SC3423	(@)	
							<b>2SA949</b>	<b>2SC2229</b>	(♣)	
0.1										<b>2SC2230</b> (♣)
0.4	<b>2SA817A</b>									
	2SA1202	2SC2882								
0.8							<b>2SA965</b>	<b>2SC2235</b>	(♣)	
							2SA1425	2SC3665	(§)	
1							TPCP8603	TPCP8507	(P)	
								TPCP8510 *	(P)	
								2SC6061	(♣)	
										<b>2SA1013</b> <b>2SC2383</b> (♣)
1.5								2SC2073A	(▲)	2SA1225 (◇)
										2SA2219 * 2SC6139 * (§)
										TTA004 * TTC004 * (@)
2	<b>2SA1315</b>	<b>2SC3328</b>								
	2SA1429	2SC3669								
		2SC6079								
	2SA2206	2SC6124								
							TPCP8501	(P)		
3	2SA1926									
	TTA003									
		2SC6076								
		TTC009 *								
5		2SC3303								
6		2SC4688								
		<b>2SC5196</b>								
8								2SC4689	(▼)	
								2SC5197	(▽)	
10								2SC4690 (140 V)	(▼)	
							<b>2SA1941</b>	<b>2SC5198</b> (140 V)	(▽)	
12	2SA1452A	2SC3710A								2SA1942 2SC5199 (※)
18										TTA0001 * TTC0001 * (▽) TTA0002 * TTC0002 * (※)

• The products shown in bold are also manufactured in offshore fabs.

• Contact the Toshiba sales representative for information about RoHS compliance before you purchase any components.

\*: New product

Legend

Package			Other Remarks
Through-Hole Package	Ammo Packaging	Surface-Mount Package	
(♣) LSTW	○	(♣) TSM	(%) Darlington
(§) MSTW	○	(◎) PW-Mini	(#) Built-in zener diode
(@) TO-126	x	(◇) PW-Mold	Part number in italic signifies built in Freewheel diode.
(▲) TO-220NIS	x	(Δ) VS-6	2SA****/2SC****: Complementary
(◇) PW-Mold	x	(P) PS-8	(&) 2-in-1 (transistor + diode)
(▽) TO-3P(N)	x	(V) SMV	(§) 2-in-1 (transistor + S-MOS)
(▼) TO-3P(N)IS	x	(♥) TFP	(W) 2-in-1 (NPN (or PNP) × 2)
(※) TO-3P(L)	x		(M) 2-in-1 (NPN + PNP)

V <sub>CEO</sub> (V)	I <sub>C</sub> (A)	(180)/200	230	300	(370)/400
0.05					<b>2SC5122</b> (♣) 2SC5307 (⊙)
0.1		2SC2230A (♣) (180 V)		2SA1432 2SC3672 (⊙)  <b>2SC4544</b> (▲) 2SA1384 2SC3515 (⊙)	
0.3					TPCP8604 (P)
0.5					TTC013 * (⊙) (350 V) 2SA1971 (⊙) <b>2SA1972</b> (♣)
0.8					2SC5458 (◇)
1			2SA1837 2SC4793 (▲)  TTC011 * (@)	<b>2SC5930</b> (⊙) (285 V) <b>2SC6010</b> (⊙) (285 V) <b>2SC6034</b> (⊙) (285 V) TTC005 * (⊙) (285 V)	2SC5549 (♣)  <b>2SC6042</b> (⊙) (375 V) 2SC6040 (⊙) (410 V) TPCP8508 ++ (P) (375 V)
1.5				TTC008 * (◇) (285 V)	2SC6142 (◇) (375 V) TTC003 * (◇) TTC13003L * (♣)
2		<b>2SC5171</b> (▲) (180 V)			2SC5548 (◇) (370 V) 2SC5548A (◇) 2SA2034 TTC012 * (◇) (375 V)
3					2SC5459 (▲)
5					2SC5172 (▲) 2SC6138 ++ (◇) (375 V)
10					2SC5352 (▽)
12	2SA2120 2SC5948 (▽)				
15	2SA2121 2SC5949 (※)		2SA1943 2SC5200 (※) <b>2SA1962</b> 2SC5242 (▽) 2SA1986 2SC5358 (▽) 2SA1987 2SC5359 (※) TTA1943 * TTC5200 * (※)		

• The products shown in bold are also manufactured in offshore fabs.

• Contact the Toshiba sales representative for information about RoHS compliance before you purchase any components.

\*: New product

++: Being planned

### Legend

Package		Surface-Mount Package	Other Remarks
Through-Hole Package	Ammo Packaging		
(♣) LSTM	○	(▲) TSM	(%) Darlington
(⊙) MSTM	○	(⊙) PW-Mini	(#) Built-in zener diode
(@) TO-126	×	(◇) PW-Mold	Part number in italic signifies built in Freewheel diode.
(▲) TO-220NIS	×	(Δ) VS-6	2SA****/2SC****: Complementary
(◇) PW-Mold	×	(P) PS-8	(&) 2-in-1 (transistor + diode)
(▽) TO-3P(N)	×	(V) SMV	(⊙) 2-in-1 (transistor + S-MOS)
(▼) TO-3P(N)IS	×	(♥) TFP	(W) 2-in-1 (NPN (or PNP) × 2)
(※) TO-3P(L)	×		(M) 2-in-1 (NPN + PNP)

### Radio-Frequency Switching Power Transistors (2SA/2SC/TTA/TTT Series) (Continued)

$V_{CE0}$ (V)	(550)/600	800	1000/(1200)
0.05	2SC5201 (♣)	2SC5460 (@) 2SC5466 (▲) 2SC6127 (◇)	2SC4686 (▲) 2SC4686A (▲) (1200 V)
0.5	2SA2142 (◇)		
0.8		2SC3405 (◇)	
1	2SA2184 (550 V) (◇)		
3		<b>2SC5353</b> (▲)	
5		2SC5354 (▽)	
10		2SC3307 (※)	

- The products shown in bold are also manufactured in offshore fabs.
- Contact the Toshiba sales representative for information about RoHS compliance before you purchase any components.

### Legend

Package			Other Remarks
Through-Hole Package	Ammo Packaging	Surface-Mount Package	
(♣) LSTM	○	(♣) TSM	(%) Darlington
(\$) MSTM	○	(⊙) PW-Mini	(#) Built-in zener diode
(@) TO-126	×	(◇) PW-Mold	Part number in italic signifies built in Freewheel diode.
(▲) TO-220NIS	×	(Δ) VS-6	2SA****/2SC****: Complementary
(◇) PW-Mold	×	(P) PS-8	(&) 2-in-1 (transistor + diode)
(▽) TO-3P(N)	×	(V) SMV	(\$) 2-in-1 (transistor + S-MOS)
(▼) TO-3P(N)IS	×	(♥) TFP	(W) 2-in-1 (NPN (or PNP) × 2)
(※) TO-3P(L)	×		(M) 2-in-1 (NPN + PNP)

## Low-Frequency Power Transistors (2SB/2SD/TTB/TTD Series)

V <sub>CEO</sub> (V) I <sub>C</sub> (A)	30	40	60/(65)
0.8			2SD2719 (#)(%)(▲)
1			2SD2686 (#)(%)(◎)
1.5	2SD1140 (%)(♣) 2SD1631 (%)(§)		
2			<b>2SD2088</b> (#)(%)(♣) <b>2SD2695</b> (#)(%)(♣) 2SD2352 (▲)
3		2SB907 (%)(◇)	2SB906 2SD1221 (◇) <b>2SB1375</b> <b>2SD2012</b> (▲) TTB001 * (♥) TTB002 * (◇)
4			2SD2204 (#)(%)(▲) (65 V)
5			2SD2131 (#)(%)(▲)

- The products shown in bold are also manufactured in offshore fabs.
  - Contact the Toshiba sales representative for information about RoHS compliance before you purchase any components.
- \*: New product

### Legend

Package			Other Remarks
Through-Hole Package	Ammo Packaging	Surface-Mount Package	
(♣) LSTM	○	(♣) TSM	(%) Darlington
(§) MSTM	○	(◎) PW-Mini	(#) Built-in zener diode
(@) TO-126	×	(◇) PW-Mold	Part number in italic signifies built in Freewheel diode.
(▲) TO-220NIS	×	(Δ) VS-6	2SA****/2SC****: Complementary
(◇) PW-Mold	×	(P) PS-8	(&) 2-in-1 (transistor + diode)
(▽) TO-3P(N)	×	(V) SMV	(§) 2-in-1 (transistor + S-MOS)
(▼) TO-3P(N)IS	×	(♥) TFP	(W) 2-in-1 (NPN (or PNP) × 2)
(※) TO-3P(L)	×		(M) 2-in-1 (NPN + PNP)

Low-Frequency Power Transistors (2SB/2SD/TTB/TTD Series) (Continued)

V <sub>CEO</sub> (V)	80		100		120	150/(160)		450
0.9					TPCP8L01(t) (&)(P)			
1.5						2SB905	2SD1220 (◇)	
2	<i>2SB1067</i>	<i>2SD1509</i> (%)(@)	<b>2SB1457</b>	<i>2SD2206</i> (%) (♣) <i>2SD2536</i> (#) (%) (♣)				
3			<i>2SB1495</i>	<i>2SD2257</i> (%) (▲) <i>2SD2092</i> (▲) <i>2SD2129</i> (%) (▲)				
4	<i>2SB908</i>	<i>2SD1223</i> (%) (◇)	<i>2SB1481</i>	<i>2SD2241</i> (%) (▲)				
5				<i>2SD2079</i> (%) (▲) <b>2SD2604</b> (#) (%) (▲)				
7			<i>2SB1020A</i>	<i>2SD1415A</i> (%) (▲)				
8							2SD2636 (%) (▽) (160 V)	
15				<i>2SD1662</i> (%) (▽)				2SD1314 (%) (※)
30				<i>2SD1525</i> (%) (※)				

(1) NPN + HED (200 V/1 A)

- The products shown in bold are also manufactured in offshore fabs.
- Contact the Toshiba sales representative for information about RoHS compliance before you purchase any components.

Legend

Package			Other Remarks
Through-Hole Package	Ammo Packaging	Surface-Mount Package	
(♣) LSTM	○	(♣) TSM	(%) Darlington
(§) MSTM	○	(◎) PW-Mini	(#) Built-in zener diode
(@) TO-126	×	(◇) PW-Mold	Part number in italic signifies built in Freewheel diode.
(▲) TO-220NIS	×	(Δ) VS-6	2SA****/2SC****: Complementary
(◇) PW-Mold	×	(P) PS-8	(&) 2-in-1 (transistor + diode)
(▽) TO-3P(N)	×	(V) SMV	(§) 2-in-1 (transistor + S-MOS)
(▼) TO-3P(N)IS	×	(♥) TFP	(W) 2-in-1 (NPN (or PNP) × 2)
(※) TO-3P(L)	×		(M) 2-in-1 (NPN + PNP)

### Transistors for Power Amps (Drive Stage)

Part Number		Ic (A)	V <sub>CEO</sub> (V)	Pc (W) T <sub>C</sub> = 25°C (♣ Ta = 25°C)	f <sub>r</sub> (MHz) Typ. (NPN/PNP)			Package
NPN	PNP					V <sub>CE</sub> (V)	Ic (A)	
2SC2235	2SA965	0.8	120	♣ 0.9	120	5	0.1	LSTM
2SC3665	2SA1425	0.8	120	♣ 1	120	5	0.1	MSTM
2SC6139 *	2SA2219 *	1.5	160	♣ 1	100	10	0.1	
2SC3423	2SA1360	0.05	150	5	200	5	0.01	TO-126
TTC004 *	TTA004 *	1.5	160	10	100	10	0.1	
2SC4793	2SA1837	1	230	20	100/70	10	0.1	TO-220NIS

• Contact the Toshiba sales representative for information about RoHS compliance before you purchase any components.

\*: New product

### (Output Stage)

Part Number		Ic (A)	V <sub>CEO</sub> (V)	Pc (W) T <sub>C</sub> = 25°C	f <sub>r</sub> (MHz) Typ. (NPN/PNP)			Package
NPN	PNP					V <sub>CE</sub> (V)	Ic (A)	
2SC5198	2SA1941	10	140	100	30	5	1	TO-3P(N)
TTC0001 *	TTA0001 *	18	160	150	30	10	1	
2SC5242	2SA1962	15	230	130	30	5	1	
2SC5358	2SA1986	15	230	150	30	5	1	
2SC5948	2SA2120	12	200	200	30/25	5	1	
2SC5199	2SA1942	12	160	120	30	5	1	TO-3P(L)
TTC0002 *	TTA0002 *	18	160	180	30	10	1	
2SC5200	2SA1943	15	230	150	30	5	1	
TTC5200 *	TTA1943 *	15	230	150	30	5	1	
2SC5359	2SA1987	15	230	180	30	5	1	
2SC5949	2SA2121	15	200	220	30/25	5	1	

• Contact the Toshiba sales representative for information about RoHS compliance before you purchase any components.

\*: New product

## Transistors for MOS Gate Drivers/Compact Motor Drivers (2-in-1 Transistors)

Part Number	Polarity	Absolute Maximum Ratings				hFE				VCE(sat)			Package	Circuit Configuration (Top View)
		VCEO (V)	IC (A)	ICP (A)	PC (Note 1) (mW)	Min	Max	VCE (V)	IC (A)	VCE(sat) (V)	IC (A)	IB (mA)		
HN4B101J	PNP	-30	-1.0	-5	550	200	500	-2	-0.12	-0.2	-0.4	-13	SMV	
	NPN	30	1.2	5	550	200	500	2	0.12	0.17	0.4	13		
HN4B102J	PNP	-30	-1.8	-8	750	200	500	-2	-0.2	-0.2	-0.6	-20	SMV	
	NPN	30	2	8	750	200	500	2	0.2	0.14	0.6	20		
TPC6901A	PNP	-50	-0.7	-5	400	200	500	-2	-0.1	-0.23	-0.3	-10	VS-6	
	NPN	50	1	5	400	400	1000	2	0.1	0.17	0.3	6		
TPC6902	PNP	-30	-1.7	-8	700	200	500	-2	-0.2	-0.2	-0.6	-20	VS-6	
	NPN	30	2	8	700	200	500	2	0.2	0.14	0.6	20		
TPCP8901	PNP	-50	-0.8	-5	830	200	500	-2	-0.1	-0.2	-0.3	-10	PS-8	
	NPN	50	1	5	830	400	1000	2	0.1	0.17	0.3	6		
TPCP8902	PNP	-30	-2	-8	890	200	500	-2	-0.2	-0.2	-0.6	-20	PS-8	
	NPN	30	2	8	890	200	500	2	0.2	0.14	0.6	20		

Note 1: The rating applies when the transistor is mounted on an FR4 board (Cu area = 645 mm<sup>2</sup>, glass-epoxy, t = 1.6 mm) and is in single-device operation.  
Copper thickness: 35 μm for the TPC6901A and 70 μm for the other transistors

- Contact the Toshiba sales representative for information about RoHS compliance before you purchase any components.

## (1-in-1 Transistors)

Part Number	Polarity	Absolute Maximum Ratings			hFE				VCE(sat)			Complementary	Package	Remarks
		VCEO (V)	IC (A)	PC (Note 1) (mW)	Min	Max	VCE (V)	IC (A)	VCE(sat) (V)	IC (A)	IB (mA)			
2SA2058	PNP	-10	-1.5	500	200	500	-2	-0.2	-0.19	-0.6	-20	2SC5755		
2SA2065		-20	-1.5	500	200	500	-2	-0.15	-0.14	-0.5	-17	2SC5784		
2SA2061		-20	-2.5	625	200	500	-2	-0.5	-0.19	-1.6	-53	2SC5735		
TTA007 *		-50	-1	700	200	500	-2	-0.1	-0.2	-0.3	-10	TTC007 *		
2SA2056		-50	-2	625	200	500	-2	-0.3	-0.20	-1.0	-33	2SC5692		
2SC5755		10	2	500	400	1000	2	0.2	0.12	0.6	12	2SA2058		
2SC5784	NPN	20	1.5	500	400	1000	2	0.15	0.12	0.5	10	2SA2065		(Note 2)
2SC5738		20	3.5	625	400	1000	2	0.5	0.15	1.6	32	2SA2061		
2SC6062		30	5	800	250	400	2	0.5	0.12	1.6	53	—		
TTC007 *		50	1	700	400	1000	2	0.1	0.12	0.3	6	TTA007 *		
2SC5692		50	2.5	625	400	1000	2	0.3	0.14	1.0	20	2SA2056		
2SA2066		PNP	-10	-2	1000	200	500	-2	-0.2	-0.19	-0.6	-20		
2SA2069	-20		-1.5	1000	200	500	-2	-0.15	-0.14	-0.5	-17	2SC5819		
2SA2059	-20		-3	1000	200	500	-2	-0.5	-0.19	-1.6	-53	2SC5714		
2SA2070	-50		-1	1000	200	500	-2	-0.1	-0.20	-0.3	-10	2SC5810		
2SA2060	-50		-2	1000	200	500	-2	-0.3	-0.20	-1.0	-33	2SC5712		
2SC5785	10		2	1000	400	1000	2	0.2	0.12	0.6	12	2SA2066		
2SC5819	NPN	20	1.5	1000	400	1000	2	0.15	0.12	0.5	10	2SC2069		
2SC5714		20	4	1000	400	1000	2	0.5	0.15	1.6	32	2SA2059		
2SC5810		50	1	1000	400	1000	2	0.1	0.17	0.3	6	2SA2070		
2SC5712		50	3	1000	400	1000	2	0.3	0.14	1	20	2SA2060		
2SC6126		50	3	1000	250	400	2	0.3	0.18	1	33	—		

Note 1: The rating applies when the transistor is mounted on an FR4 board (Cu area = 645 mm<sup>2</sup>, t = 1.6 mm).

\*: New product

Note 2: Ultra-high-speed using by the Super Hi-Met process and Low VCE(sat) products.

- Contact the Toshiba sales representative for information about RoHS compliance before you purchase any components.

## Transistors for Switching Power Supplies (For AC/DC Converters)

Part Number	Applications	Absolute Maximum Ratings (Ta = 25°C)				Package
		V <sub>CB0</sub> (V)	V <sub>CE0</sub> (V)	I <sub>c</sub> (A)	P <sub>c</sub> (W) T <sub>c</sub> = 25°C (♣ Ta = 25°C)	
2SC5930	Switching regulator	600	285	1	1♣	MSTM
2SC6010				1	1♣	MSTM
2SC6034				1	1♣	MSTM
TTC008 *				1.5	1.1♣	PW-Mold
2SC5548				2	15	PW-Mold
2SC5548A			2	15	PW-Mold	
2SC5458			0.8	10	PW-Mold	
TTC003 *			1.5	1.1♣	PW-Mold	
2SC5459			3	25	TO-220NIS	
2SC5172			5	25	TO-220NIS	
2SC5352		10	80	TO-3P(N)		
2SC6042		800	375	1	1♣	MSTM
2SC6040				1	1♣	MSTM
2SC6142			375	1.5	1.1♣	PW-Mold
TTC012 *				2	1.1♣	PW-Mold
2SC5353		900	800	3	25	TO-220NIS
2SC5354				5	100	TO-3P(N)
2SC3307				10	150	TO-3P(L)

• Contact the Toshiba sales representative for information about RoHS compliance before you purchase any components.

\*: New product

## Current Control Transistors for LED Backlighting

Part Number	Absolute Maximum Ratings			h <sub>FE</sub>				V <sub>CE(sat)</sub>			Package
	V <sub>CE0</sub> (V)	I <sub>c</sub> (A)	P <sub>c</sub> (W)	h <sub>FE</sub>		V <sub>CE</sub> (V)	I <sub>c</sub> (A)	V <sub>CE(sat)</sub> (V)	I <sub>c</sub> (A)	I <sub>B</sub> (mA)	
				Min	Max						
TTC005 *	285	1	1.1 (Note 1)	100	200	5	0.1	1	0.6	75	PW-Mini
TTC011 *	230	1	10 (Note 2)	100	320	5	0.2	1	0.3	30	TO-126
TTC013 *	350	0.5	1 (Note 1)	100	200	5	0.05	0.3	0.16	20	PW-Mini

Note 1: The rating applies when the transistor is mounted on an FR4 board (Cu area = 645 mm<sup>2</sup>, glass-epoxy, t = 1.6 mm).

Note 2: T<sub>c</sub> = 25°C

\*: New product

• Contact the Toshiba sales representative for information about RoHS compliance before you purchase any components.



## Transistors for High-Voltage Power Supplies (For DC/DC Converters)

Part Number	Absolute Maximum Ratings				hFE				VCE (sat) (V)			Package
	VCEX (V)	VCEO (V)	Ic (A)	Pc (W)			VCE (V)	Ic (A)	Max	Ic (A)	Ib (mA)	
					Min	Max						
2SC6061	150	120	1	0.625 (Note 1)	120	300	2	0.1	0.14	0.3	10	TSM
TPCP8510 *	150	120	1	1.1 (Note 1)	120	300	2	0.1	0.14	0.3	10	PS-8
TPCP8507	150	120	1	1.25 (Note 1)	120	300	2	0.1	0.14	0.3	10	PS-8
2SC6076	160	80	3	10 (Note 2)	180	450	2	0.5	0.5	1	100	PW-Mold
2SC6124	160	80	2	1 (Note 1)	100	200	2	0.5	0.5	1	100	PW-Mini
TTC009 *	160	80	3	15 (Note 2)	100	200	2	0.5	0.5	1	100	TO-220NIS
2SC6079	160	80	2	1 (Note 3)	180	450	2	0.5	0.5	1	100	MSTM

Note 1: The rating applies when the transistor is mounted on an FR4 board (Cu area = 645 mm<sup>2</sup>, glass-epoxy, l = 1.6 mm).

\*: New product

Note 2: Tc = 25°C

Note 3: Ta = 25°C

- Contact the Toshiba sales representative for information about RoHS compliance before you purchase any components.

## (Transistors for Droppers)

Part Number	Absolute Maximum Ratings			hFE				VCE (sat) (V)			Package
	VCEO (V)	Ic (A)	Pc (W) Tc = 25°C			VCE (V)	Ic (A)	Max	Ic (A)	Ib (mA)	
				Min	Max						
2SB906	-60	-3	20	60	200	-5	-0.5	-1.7	-3	-300	PW-Mold
TTB001 *	-60	-3	36	100	250	-5	-0.5	-1.7	-3	-300	TFP
TTB002 *	-60	-3	25	100	250	-5	-0.5	-1.7	-3	-300	PW-Mold

- Contact the Toshiba sales representative for information about RoHS compliance before you purchase any components.

\*: New product

## (High-Voltage Transistors)

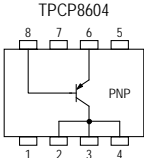
Part Number	Absolute Maximum Ratings			Package	Circuit Configuration (Top View)	Remarks
	VCEO (V)	Ic (A)	Pc (W)			
2SA1972	-400	-0.5	0.9	LSTM		
2SA1971	-400	-0.5	1	PW-Mini		
TPCP8604	-400	-0.3	1	PS-8		SMD
2SA2184	-550	-1	1	PW-Mold		SMD only
2SA2142	-600	-0.5	10	PW-Mold		SMD only
2SC5122	400	0.05	0.9	LSTM		
2SC5307	400	0.05	1	PW-Mini		
2SC5201	600	0.05	0.9	LSTM		
2SC6127	800	0.05	10	PW-Mold		
2SC5460	800	0.05	10	TO-126		
2SC5466	800	0.05	10	TO-220NIS		
2SC4686A	1200	0.05	10	TO-220NIS		
2SC5563	1500	0.02	10	TO-220NIS		SMD only

- The circuit configuration diagrams only show the general configurations of the circuits.

- Contact the Toshiba sales representative for information about RoHS compliance before you purchase any components.

Low Saturation Voltage Transistors (Small Surface-Mount Packages for Personal Equipments)

Part Number	Configuration	Absolute Maximum Ratings					hFE				VCE (sat) (V)			Marking	Package	
		VCE0 (V)	Ic (A)	ICP (A)	Pc (mW) (Note 1)	Pc (mW) (Note 1) t = 10 s	Min	Max	VCE (V)	Ic (A)	Max	Ic (A)	Ib (mA)			
2SA2058	PNP single	-10	-1.5	-2.5	500	750	200	500	-2	-0.2	-0.19	-0.6	-20	WM	TSM (equivalent to SC-59 SOT-23)	
2SA2065		-20	-1.5	-2.5	500	750	200	500	-2	-0.15	-0.14	-0.5	-17	WK		
2SA2061		-20	-2.5	-4	625	1000	200	500	-2	-0.5	-0.19	-1.6	-53	WE		
TTA007 *		-50	-1	-2	700	1100	200	500	-2	-0.1	-0.2	-0.3	-10	WH		
2SA2056		-50	-2	-3.5	625	1000	200	500	-2	-0.3	-0.20	-1.0	-33	WF		
2SC5755	NPN single	10	2	3.5	500	750	400	1000	2	0.2	0.12	0.6	12	WL		
2SC5784		20	1.5	2.5	500	750	400	1000	2	0.15	0.12	0.5	10	WJ		
2SC5738		20	3.5	6	625	1000	400	1000	2	0.5	0.15	1.6	32	WD		
2SC5976		30	3	5	625	1000	250	400	2	0.3	0.14	1.0	33	WW		
2SC5906		30	4	7	800	1250	200	500	2	0.5	0.2	1.6	53	WP		
2SC6062		30	5	10	800	1250	250	400	2	0.5	0.12	1.6	53	WR		
TTC007 *		50	1	2	700	1100	400	1000	2	0.1	0.12	0.3	6	WG		
2SC5692		50	2.5	4	625	1000	400	1000	2	0.3	0.14	1.0	20	WB		
2SC6033		50	2.5	5	625	1000	250	400	2	0.3	0.18	1.0	33	WX		
2SC5703		50	4	7	800	1250	400	1000	2	0.5	0.12	1.6	32	WA		
2SC6061		120	1	2	625	1000	120	300	2	0.1	0.14	0.3	10	WN		
HN4B101J		PNP + NPN	±30	-1/1.2	±5	550	850	200	500	±2	±0.12	-0.2/0.17	±0.4	±13	5K	SMV
HN4B102J			±30	-1.8/2	±8	750	750	200	500	±2	±0.2	-0.2/0.14	±0.6	±20	5L	
2SA2066	PNP single	-10	-2	-3.5	1000	2000	200	500	-2	-0.2	-0.19	-0.6	-20	4E	PW-Mini (equivalent to SC-62 SOP-89)	
2SA2069		-20	-1.5	-2.5	1000	2000	200	500	-2	-0.15	-0.14	-0.5	-17	4D		
2SA2059		-20	-3	-5	1000	2500	200	500	-2	-0.5	-0.19	-1.6	-53	4F		
2SA2070		-50	-1	-2	1000	2000	200	500	-2	-0.1	-0.2	-0.3	-10	4C		
2SA2060		-50	-2	-3.5	1000	2500	200	500	-2	-0.3	-0.20	-1.0	-33	4G		
2SA2206		-80	-2	-4	1000	2500	100	200	-2	-0.5	-0.5	-1.0	-100	4K		
2SC5785	NPN single	10	2	3.5	1000	2000	400	1000	2	0.2	0.12	0.6	12	3E		
2SC5713		10	4	7	1000	2500	400	1000	2	0.5	0.15	1.6	32	2C		
2SC5819		20	1.5	2.5	1000	2000	400	1000	2	0.15	0.12	0.5	10	3D		
2SC6125		20	4	8	1000	2500	180	390	2	0.5	0.2	1.6	53	4L		
2SC5714		20	4	7	1000	2500	400	1000	2	0.5	0.15	1.6	32	2E		
2SC5810		50	1	2	1000	2000	400	1000	2	0.1	0.17	0.3	6	3C		
2SC6126		50	3	6	1000	2500	250	400	2	0.3	0.18	1.0	33	4M		
2SC5712		50	3	5	1000	2500	400	1000	2	0.3	0.14	1	20	2A		
2SC6124		80	2	4	1000	2500	100	200	2	0.5	0.5	1.0	100	4J		
TPC6501	NPN single	10	2	3.5	800	1600	400	1000	2	0.2	0.12	0.6	12	H2A	VS-6 (equivalent to TSOP-6)	
TPC6502		50	3	5	800	1600	400	1000	2	0.3	0.14	1	20	H2B		
TPC6503		20	1.5	2.5	800	1600	400	1000	2	0.15	0.12	0.5	10	H2C		
S3F61 ++		10	4	6	800	1600	400	1000	2	0.5	0.15	1.6	32	—		
S3F62 ++		20	4	6	800	1600	400	1000	2	0.5	0.15	1.6	32	—		
TPC6504 *		50	1	2	800	1600	400	1000	2	0.1	0.17	0.3	6	H2D		
TPC6601	PNP single	-50	-2	-3.5	800	1600	200	500	-2	-0.3	-0.20	-1.0	-33	H3A		
TPC6602		-10	-2	-3.5	800	1600	200	500	-2	-0.2	-0.19	-0.6	-20	H3B		
TPC6603		-20	-3	-5	800	1600	200	500	-2	-0.5	-0.19	-1.6	-53	H3C		
S3F56 ++		-20	-1.5	-2.5	800	1600	200	500	-2	-0.15	-0.14	-0.5	-17	—		
TPC6604 *		-50	-1	-2	800	1600	200	500	-2	-0.1	-0.23	-0.3	-10	H3D		
TPC6701	NPN/dual	50	1	2	660 (Note2)	—	400	1000	2	0.1	0.17	0.3	6	H4A		
TPC6901A	PNP + NPN	±50	-0.7/1.0	±5	400	500	200/400	500/1000	±2	±0.1	-0.23/0.17	±0.3	-10/6	H6B		
TPC6902		±30	-1.7/2	±8	700	1000	200	500	±2	±0.2	-0.2/0.14	±0.6	±20	H6C		

Note 1: The rating applies when the transistor is mounted on an FR4 board (Cu area = 645 mm<sup>2</sup>, glass-epoxy, t = 1.6 mm).

\*: New product

Note 2: Total loss of dual-device operation

++: Being planned

- Contact the Toshiba sales representative for information about RoHS compliance before you purchase any components.

Low Saturation Voltage Transistors (Small Surface-Mount Packages for Personal Equipments) (Continued)

Part Number	Configuration	Absolute Maximum Ratings					hFE				VCE (sat) (V)			Marking	Package
		V <sub>CEO</sub> (V)	I <sub>C</sub> (A)	I <sub>CP</sub> (A)	P <sub>C</sub> (mW) (Note 1)	P <sub>C</sub> (mW) (Note 1) t = 10 s	Min	Max	V <sub>CE</sub> (V)	I <sub>C</sub> (A)	Max	I <sub>C</sub> (A)	I <sub>B</sub> (mA)		
2SA2097	PNP single	-50	-5	-10	20 (Note 3)	—	200	500	-2	-0.5	-0.27	-1.6	-53	A2097	PW-Mold SC-63
2SA1241		-50	-2	-3	10 (Note 3)	—	70	240	-2	-0.5	-0.5	-1	-50	A1241	
2SA1244		-50	-5	-8	20 (Note 3)	—	70	240	-1	-1	-0.4	-3	-150	A1244	
TTA003 *	NPN single	-80	-3	-5	10 (Note 3)	—	100	200	-2	-0.5	-0.5	-1	-100	A003	
2SC6076		80	3	5	10 (Note 3)	—	180	450	2	0.5	0.5	1	100	C6076	
2SC5886		50	5	10	20 (Note 3)	—	400	1000	2	0.5	0.22	1.6	32	C5886	
2SC5886A		50	5	10	20 (Note 3)	—	400	1000	2	0.5	0.22	1.6	32	C5886A	
2SC3076		50	2	3	10 (Note 3)	—	70	240	2	0.5	0.5	1	50	C3076	
2SC6052		20	5	7	10 (Note 3)	—	180	390	2	0.5	0.2	1.6	53	C6052	
2SC3074		50	5	8	20 (Note 3)	—	70	240	1	1	0.4	3	150	C3074	
S3H32 ++		50	5	7	20 (Note 3)	—	200	500	2	0.5	0.2	1.6	53		
2SC3303		80	5	8	20 (Note 3)	—	70	240	1	1	0.4	3	150	C3303	
2SC6000		50	7	10	20 (Note 3)	—	250	400	2	2.5	0.18	2.5	83	C6000	
TPCP8501	NPN single	100	2	4	1300	3300	100	300	2	0.3	0.2	1	33	8501	PS-8
TPCP8507		120	1	2	1250	3000	120	300	2	0.1	0.14	0.3	10	8507	
TPCP8510 *		120	1	2	1100	2250	120	300	2	0.1	0.14	0.3	10	8510	
TPCP8511 *		50	3	5	1250	3000	250	400	2	0.3	0.18	1	33	8511	
TPCP8505		50	3	5	1250	3000	400	1000	2	0.3	0.14	1	20	8505	
TPCP8504		10	2	3.5	1200	2800	400	1000	2	0.2	0.12	0.6	12	8504	
TPCP8601	PNP single	-20	-4	-7	1300	3300	200	500	-2	-0.6	-0.19	-2	-67	8601	
TPCP8603		-120	-1	-2	1250	3000	120	300	-2	-0.1	-0.2	-0.3	-10	8603	
TPCP8602		-50	-2.5	-4	1250	3000	200	500	-2	-0.3	-0.2	-1	-33	8602	
TPCP8701	NPN/dual	50	3	5	940	1770	400	1000	2	0.3	0.14	1	20	8701	
TPCP8H01 (Note 2)	NPN +	50	5	7	1000	2000	250	400	2	0.5	0.13	1.6	53	8H01	
TPCP8H02 (Note 2)	S-MOS	30	3	5	1000	2000	250	400	2	0.3	0.14	1	33	8H02	
TPCP8F01 (Note 2)	PNP + S-MOS	-20	-3	-5	1000	—	200	500	-2	-0.5	-0.19	-1.6	-53	8F01	
TPCP8901	PNP + NPN	±50	-0.8/1.0	±5	830	1480	200/400	500/1000	±2	±0.1	-0.2/0.17	±0.3	-10/6	8901	
TPCP8902		±30	±2	±8	890	1670	200	500	±2	±0.2	-0.2/0.14	±0.6	±20	8902	
TPCP8L01 (Note 4)	NPN Darlington + HED	120	0.9	2	900	—	2000	9000	2	1	1.5	1	1	8L01	
TPCP8G01 (Note 5) *	PNP + Pch	-20	-3	-5	940	1770	200	500	-2	-0.5	-0.19	-1.6	-53	8G01	

Note 1: The rating applies when the transistor is mounted on an FR4 board (Cu area = 645 mm<sup>2</sup>, glass-epoxy, t = 1.6 mm).

Note 2: Built-in SBD, V<sub>RRM</sub> = 30 V, I<sub>O</sub> = 0.7 A, V<sub>F</sub> = 0.4 V (MAX)@I<sub>F</sub> = 0.5 A, I<sub>R</sub> = 100 μA (MAX)@V<sub>R</sub> = 10 V

Note 3: T<sub>C</sub> = 25°C

Note 4: Built-in HED, V<sub>RRM</sub> = 200 V, I<sub>F</sub>(AV) = 1 A

Note 5: Pch MOS V<sub>DSS</sub> = -20 V, I<sub>D</sub> = -2 A, R<sub>ON</sub> = 130 mΩ Max

• Contact the Toshiba sales representative for information about RoHS compliance before you purchase any components.

\*: New product

++: Being planned

(Power-Mold Transistors (SC-63/64) )

Part Number	Applications	Absolute Maximum Ratings (Ta = 25°C)				Complementary	Equivalent Product	Remarks
		V <sub>CEO</sub> (V)	I <sub>c</sub> (A)	P <sub>c</sub> (W)	★P <sub>c</sub> (W)			
2SA1225	Power amplification for driver	-160	-1.5	1.0	15	—	—	
2SA1241	Power amplification	-50	-2.0	1.0	10	2SC3076	2SA1892	
2SC3076		50	2.0	1.0	10	2SA1241	2SC5029	
2SA1242	Strobe flash, power amplification	-20	-5.0	1.0	10	2SC3072 (★★)	2SA1893	
2SC3072		20	5.0	1.0	10	2SA1242 (★★)	2SC3420	
2SA1244	High-current switching	-50	-5.0	1.0	20	2SC3074	2SA1905	
2SC3074		50	5.0	1.0	20	2SA1244	2SC5076	
2SA2097		-50	-5.0	1.0	20	—	—	High β
2SC5886		50	5.0	1.0	20	—	—	High β
2SC5886A		50	5	1.0	20	—	—	High β, V <sub>CEO</sub> = 120 V
2SB905	TV vertical output, TV audio output (B) class	-150	-1.5	1.0	10	2SD1220	2SA1408	
2SD1220		150	1.5	1.0	10	2SB905	2SC3621	
2SB906	Low-frequency power amplification	-60	-3.0	1.0	20	2SD1221	2SB834	
2SD1221		60	3.0	1.0	20	2SB906	2SD880	
TTB002 *		-60	-3.0	1.0	30	—	—	
TTA003 *		-80	-3.0	—	10	—	—	
2SB907	Switching, power amplification	-40	-3.0	1.0	15	—	—	Darlington type
2SC6076		80	3	—	10	—	—	
2SB908	Switching, power amplification	-80	-4.0	1.0	15	2SD1223	—	Darlington type
2SD1223		80	4.0	1.0	15	2SB908	—	Darlington type
2SC3303	Switching	80	5.0	1.0	20	—	2SC3258	
2SA2034	High-voltage switching	-400	-2	1.0	15	—	—	
2SA2184		-550	-1	—	10	—	—	
2SA2142		-600	-0.5	—	15	—	—	
2SC5458		400	0.8	1.0	10	—	—	
2SC5548		370	2	1.0	15	—	—	
2SC5548A		400	2	1.0	15	—	—	
2SC6127		800	0.05	1.0	10	—	—	
2SC3405		800	0.8	1.0	20	—	—	
2SC6142		375	1.5	1.1	—	—	—	
TTC003 *		400	1.5	1.1	—	—	—	
TTC008 *		285	1.5	1.1	—	—	—	
TTC012 *		375	2	1.1	—	—	—	
2SC6000		High-speed switching	50	7	1.0	20	—	—
2SC6052	20		5	1.0	10	—	—	

★: T<sub>c</sub> = 25°C

\*: New product

★★: hFE classification varies

- Contact the Toshiba sales representative for information about RoHS compliance before you purchase any components.

(PW-Mini Transistors (SC-62))

Part Number		Absolute Maximum Ratings					Electrical Characteristics										Marking		Equivalent to TO-92MOD (TO-92)		Remarks/ Applications
		Pc (W)	Pc (W)	Pc (W)	V <sub>CEO</sub> (V)	I <sub>C</sub> (A)	hFE		V <sub>CE</sub> (sat)			f <sub>T</sub>									
							Min	Max	V <sub>CE</sub> (V)	I <sub>C</sub> (mA)	(V)	I <sub>C</sub> (mA)	I <sub>B</sub> (mA)	(MHz)	V <sub>CE</sub> (V)	I <sub>C</sub> (mA)					
NPN	PNP	(Note 1)	(Note 2)									Typ.			NPN	PNP	NPN	PNP			
2SC2881	2SA1201	0.5	1.0	—	120	0.8	80	240	5	100	1.0	500	50	120	5	100	C□	D□	2SC2235	2SA965	Audio driver
2SC2882	2SA1202	0.5	1.0	—	80	0.4	70	240	2	50	0.4	200	20	120/100	10	10	E□	F□	(2SC1627)	(2SA817)	Low saturation
—	2SA1203	0.5	1.0	—	30	1.5	100	320	2	500	2.0	1500	30	120	2	500	G□	H□	2SC2236	2SA966	Audio driver
2SC2884	2SA1204	0.5	1.0	—	30	0.8	100	320	1	100	0.5/0.7	500	20	120	5	10	P□	R□	(2SC2120)	(2SA950)	Low saturation
2SC3515	2SA1384	0.5	1.0	—	300	0.1	30	150	10	20	0.5	20	2	60	10	20	I□	J□	(2SC2551)	(2SA1091)	Low saturation
—	2SA1483	0.5	1.0	—	45	0.2	40	240	1	10	0.3	100	10	200	10	10	V□	W□	—	—	Low saturation
—	2SA1971	0.5	1.0	—	-400	-0.5	140	400	-5	-100	-1.0	-100	-10	35	-5	-50	—	AL	—	2SA1972	High-voltage
2SC5785	—	—	—	1	10	2	400	1000	2	200	0.12	600	12	—	—	—	3E	—	—	—	Low saturation
—	2SA2066	—	—	1	-10	-2	200	500	-2	-200	-0.19	-600	-20	—	—	—	4E	—	—	—	Low saturation
2SC5713	—	—	—	1	10	4	400	1000	2	500	0.15	1600	32	—	—	—	2C	—	—	—	Low saturation
2SC5819	—	—	—	1	20	1.5	400	1000	2	150	0.12	500	10	—	—	—	3D	—	—	—	Low saturation
—	2SA2069	—	—	1	-20	-1.5	200	500	-2	-150	-0.14	-500	-17	—	—	—	4D	—	—	—	Low saturation
2SC6125	—	—	—	1	20	4	180	390	2	500	0.20	1600	53	—	—	—	4L	—	—	—	High-speed switching
2SC5714	—	—	—	1	20	4	400	1000	2	500	0.15	1600	32	—	—	—	2E	—	—	—	Low saturation
—	2SA2059	—	—	1	-20	-3	200	500	-2	-500	-0.19	-1600	-53	—	—	—	4F	—	—	—	Low saturation
2SC6126	—	—	—	1	50	3	250	400	2	300	0.18	1000	33	—	—	—	4M	—	—	—	High-speed switching
2SC5712	—	—	—	1	50	3	400	1000	2	300	0.14	1000	33	—	—	—	2A	—	—	—	Low saturation
—	2SA2060	—	—	1	-50	-2	200	500	-2	-300	-0.20	-1000	-20	—	—	—	4G	—	—	—	Low saturation
2SC5810	—	—	—	1	50	1	400	1000	2	100	0.17	300	6	—	—	—	3C	—	—	—	Low saturation
—	2SA2070	—	—	1	-50	-1	200	500	-2	-100	-0.2	-300	-10	—	—	—	4C	—	—	—	Low saturation
2SD2686	—	—	—	1	60±10	1	2000	—	2	1000	1.5	1000	1	—	—	—	3H	—	—	—	Darlington
2SC6124	2SA2206	—	—	1	80	2	100	200	2	500	0.5	1000	100	150/100	2	500	4J	4K	—	—	Low saturation
TTC005 *	—	—	—	1.1	285	1	100	200	5	100	1.0	600	75	—	—	—	4N	—	—	—	LED backlight
TTC013 *	—	—	—	1	350	0.5	100	200	5	50	0.3	160	20	—	—	—	4R	—	—	—	LED backlight

Note: The hFE classification that appears instead of the □ shown in the Marking column will be one of the following: A, B, C, D, O, R or Y, according to the rank.

\*: New product

Note 1: The rating applies when the transistor is mounted on a ceramic board (250 mm<sup>2</sup> x 0.8 mm).

Note 2: The rating applies when the transistor is mounted on a glass-epoxy board (645 mm<sup>2</sup> x 1.6 mm).

- Contact the Toshiba sales representative for information about RoHS compliance before you purchase any components.

(TSM Transistors)

Part Number	Absolute Maximum Ratings					hFE				V <sub>CE</sub> (sat) (V)			Marking	Remarks/ Applications
	NPN	V <sub>CEO</sub> (V)	I <sub>C</sub> (A)	I <sub>CP</sub> (A)	Pc (mW) (Note 1)	Pc (mW) (Note 1) t = 10s	Min	Max	V <sub>CE</sub> (V)	I <sub>C</sub> (A)	Max	I <sub>C</sub> (A)		
2SA2058	-10	-1.5	-2.5	500	750	200	500	-2	-0.2	-0.19	-0.6	-20	WM	Low saturation
2SA2065	-20	-1.5	-2.5	500	750	200	500	-2	-0.15	-0.14	-0.5	-17	WK	Low saturation
2SA2061	-20	-2.5	-4	625	1000	200	500	-2	-0.5	-0.19	-1.6	-53	WE	Low saturation
TTA007 *	-50	-1	-2	700	1100	200	500	-2	-0.1	-0.2	-0.3	-10	WH	Low saturation
2SA2056	-50	-2	-3.5	625	1000	200	500	-2	-0.3	-0.20	-1.0	-33	WF	Low saturation
2SC5755	10	2	3.5	500	750	400	1000	2	0.2	0.12	0.6	12	WL	Low saturation
2SC5784	20	1.5	2.5	500	750	400	1000	2	0.15	0.12	0.5	10	WJ	Low saturation
2SC5738	20	3.5	6	625	1000	400	1000	2	0.5	0.15	1.6	32	WD	Low saturation
2SC5976	30	3	5	625	1000	250	400	2	0.3	0.14	1.0	33	WW	Ultra-high-speed switching Low saturation voltage
2SC5906	30	4	7	800	1250	200	500	2	0.5	0.2	1.6	53	WP	Ultra-high-speed switching Low saturation voltage
2SC6062	30	5	10	800	1250	250	400	2	0.5	0.12	1.6	53	WR	Ultra-high-speed switching Ultra-low saturation voltage
TTC007 *	50	1	2	700	1100	400	1000	2	0.1	0.12	0.3	6	WG	Low saturation
2SC5692	50	2.5	4	625	1000	400	1000	2	0.3	0.14	1.0	20	WB	Low saturation
2SC6033	50	2.5	5	625	1000	250	400	2	0.3	0.18	1.0	33	WX	Ultra-high-speed switching Low saturation voltage
2SC5703	50	4	7	800	1250	400	1000	2	0.5	0.12	1.6	32	WA	Low saturation
2SD2719	60 ± 10	0.8	3	800	1250	2000	—	2	1.0	1.5	1	1	WV	Darlington
2SC6061	120	1	2	625	1000	120	300	2	0.1	0.14	0.3	10	WN	Low saturation



Note 1: The rating applies when the transistor is mounted on an FR4 board (Cu area = 645 mm<sup>2</sup>, glass-epoxy, t = 1.6 mm).

\*: New product

- Contact the Toshiba sales representative for information about RoHS compliance before you purchase any components.

# Radio-Frequency Bipolar Small-Signal Transistors

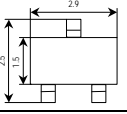
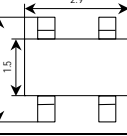
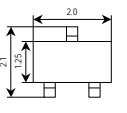
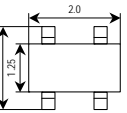
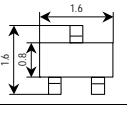
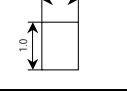
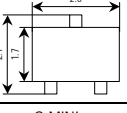
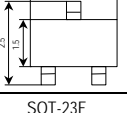
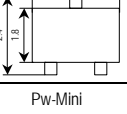
## Radio-Frequency Bipolar Transistors

Part Number	Package	Applications	Absolute Maximum Ratings (Ta = 25°C)				Marking	TO-92 Equivalent Product	Remarks
			V <sub>CEO</sub> (V)	I <sub>C</sub> (mA)	P <sub>C</sub> (mW)	T <sub>J</sub> (°C)			
<b>2SC2714</b>		FM-band radio-frequency amps	30	20	150	125	Q□	<b>2SC1923</b>	fr = 550 MHz
<b>2SC5064</b>		VHF/UHF-band low-noise amps	12	30	150	125	MA□	—	fr = 7 GHz
<b>2SC5084</b>		VHF/UHF-band low-noise amps	12	80	150	125	MC□	—	fr = 7 GHz
2SC5106		VHF/UHF-band oscillators	10	30	150	125	MF□	—	fr = 6 GHz
2SC5087		VHF/UHF-band low-noise amps	12	80	150	125	C□	—	fr = 7 GHz
2SC5087R		VHF/UHF-band low-noise amps	12	80	150	125	ZP	—	fr = 8 GHz
MT4S03A		VHF/UHF-band low-voltage operation, low phase noise	5	40	150	125	MR	—	fr = 10 GHz
<b>2SC4215</b>		FM-band radio-frequency amps	30	20	100	125	Q□	2SC1923	fr = 550 MHz
<b>2SC5065</b>		VHF/UHF-band low-noise amps	12	30	100	125	MA□	—	fr = 7 GHz
<b>2SC5085</b>		VHF/UHF-band low-noise amps	12	80	100	125	MC□	—	fr = 7 GHz
<b>2SC5095</b>		VHF/UHF-band low-noise amps	10	15	100	125	ME□	—	fr = 10 GHz
<b>2SC5107</b>		VHF/UHF-band oscillators	10	30	100	125	MF□	—	fr = 6 GHz
<b>MT3S16U</b>		VHF-band low-voltage oscillators and amps	5	60	100	125	T4	—	fr = 4 GHz
2SC5088		VHF/UHF-band low-noise amps	12	80	100	125	MC□	—	fr = 7 GHz
MT4S23U *		VHF/UHF-band low-noise amps	5	40	170 (Note 2)	150	<u>MT</u>	—	fr = 16 GHz
MT4S03BU *		VHF/UHF-band low-noise amps	5	40	175 (Note 2)	150	<u>MR</u>	—	fr = 12 GHz
MT4S24U *		VHF/UHF-band low-noise amps	5	50	175 (Note 2)	150	R8	—	fr = 14.5 GHz
<b>2SC4915</b>		FM-band radio-frequency amps	30	20	100	125	Q□	<b>2SC1923</b>	fr = 550 MHz
<b>2SC5066</b>		VHF/UHF-band low-noise amps	12	30	100	125	M1/M2	—	fr = 7 GHz
<b>2SC5086</b>		VHF/UHF-band low-noise amps	12	80	100	125	M5/M6	—	fr = 7 GHz
<b>2SC5096</b>		VHF/UHF-band low-noise amps	10	15	100	125	M9/MA	—	fr = 10 GHz
<b>2SC5108</b>		VHF/UHF-band oscillators	10	30	100	125	MB/MC	—	fr = 6 GHz
MT3S11CT		VHF/UHF-band low-voltage operation, low noise	6	40	105 (Note 1)	125	08	—	fr = 6 GHz
<b>MT3S15TU</b> *		VHF/UHF-band low-noise amps, low-distortion amps	6	80	900 (Note 2)	150	T3	—	fr = 11.5 GHz
<b>MT3S19TU</b> *		VHF/UHF-band low-noise amps, low-distortion amps	6	80	900 (Note 2)	150	T6	—	fr = 11 GHz
<b>MT3S20TU</b> *		VHF/UHF-band low-noise amps, low-distortion amps	12	80	900 (Note 2)	150	MU	—	fr = 7 GHz
<b>MT3S19</b> *		VHF/UHF-band low-noise amps, low-distortion amps	6	80	800 (Note 2)	150	T6	—	fr = 12 GHz
<b>MT3S19R</b> *		VHF/UHF-band low-noise amps, low-distortion amps	6	80	320 (Note 1)	150	T6	—	fr = 13.5 GHz
<b>MT3S20R</b> *		VHF/UHF-band low-noise amps, low-distortion amps	12	80	320 (Note 1)	150	MU	—	fr = 7.5 GHz
MT3S20P *		VHF/UHF-band low-noise amps, low-distortion amps	12	80	1800 (Note 2)	150	MU	—	fr = 7 GHz
MT3S21P *		VHF/UHF-band low-noise amps, low-distortion amps	6	80	1800 (Note 2)	150	T2	—	fr = 9 GHz
MT3S22P *		VHF/UHF-band low-noise amps, low-distortion amps	6	80	1800 (Note 2)	150	T5	—	fr = 8.5 GHz

□: Denotes a hFE class.

\*: New product

Note 1: When mounted on a glass-epoxy PCB board

Note 2: Mounted on a ceramic board

- The products shown in bold are also manufactured in offshore fabs.
- Contact the Toshiba sales representative for information about RoHS compliance before you purchase any components.

# SiGe HBT

Part Number	Package	Applications	Absolute Maximum Ratings (Ta = 25°C)				Marking	Remarks
			VCEO (V)	Ic (mA)	Pc (mW)	Tj (°C)		
MT4S102U		UHF/SHF-band low-noise amps	3	20	60	150	P8	fr = 24 GHz
MT4S300U *		UHF/SHF-band low-noise amps	4	50	100	150	P3	fr = 26.5 GHz, high ESD immunity
MT4S301U *		UHF/SHF-band low-noise amps	4	35	100	150	P4	fr = 27.5 GHz, high ESD immunity
MT4S102T		UHF/SHF-band low-noise amps	3	20	60	150	P8	fr = 25 GHz
MT4S300T *		UHF/SHF-band low-noise amps	4	50	100	150	P3	fr = 26.5 GHz, high ESD immunity
MT4S301T *		UHF/SHF-band low-noise amps	4	35	100	150	P4	fr = 27.5 GHz, high ESD immunity
<b>MT3S111</b> *		VHF/UHF-band low-voltage operation, low-noise amps	6	100	700 (Note 2)	150	R5	fr = 11.5 GHz
<b>MT3S113</b> *		VHF/UHF-band low-voltage operation, low-noise amps	5.3	100	800 (Note 2)	150	R7	fr = 12.5 GHz
<b>MT3S111TU</b> *		VHF/UHF-band low-voltage operation, low-noise amps	6	100	800 (Note 2)	150	R5	fr = 10 GHz
<b>MT3S113TU</b> *			5.3	100	900 (Note 2)	150	R7	fr = 11.2 GHz
MT3S111P *		VHF/UHF-band low-voltage operation, low-noise amps	6	100	1000 (Note 2)	150	R5	fr = 8 GHz
MT3S113P *			5.3	100	1600 (Note 2)	150	R7	fr = 7.7 GHz

Note 2: Mounted on a ceramic board

\*: New product

- The products shown in bold are also manufactured in offshore fabs.
- Contact the Toshiba sales representative for information about RoHS compliance before you purchase any components.

# Radio-Frequency Small-Signal FETs

## Radio-Frequency MOSFETs

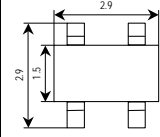
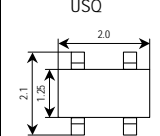
Part Number	Package	Applications	Electrical Characteristics (Ta = 25°C)					Marking	Equivalent Product (Leaded Type)
			V <sub>DS</sub> (V)	I <sub>D</sub> (mA)	P <sub>D</sub> (mW)	I <sub>DSS</sub> (mA)	Y <sub>fs</sub>   (mS) Typ.		
3SK291	 SMD	UHF-band radio-frequency amps	12.5	30	150	0 to 0.1	26	UF	—
3SK292		VHF/UHF-band radio-frequency amps	12.5	30	150	0 to 0.1	23.5	UV	—
3SK293	 USQ	UHF-band radio-frequency amps	12.5	30	100	0 to 0.1	26	UF	—
3SK294		VHF/UHF-band radio-frequency amps	12.5	30	100	0 to 0.1	23.5	UV	—

- Contact the Toshiba sales representative for information about RoHS compliance before you purchase any components.



# Radio-Frequency Power MOSFETs

## Radio-Frequency Power MOSFETs

Part Number	Package	Applications	Absolute Maximum Ratings (Tc = 25°C)			Min	Po (W)		
			V <sub>DSS</sub> (V)	P <sub>D</sub> (W)	I <sub>D</sub> (A)		Test Conditions		
							V <sub>DD</sub> (V)	f (MHz)	P <sub>i</sub> (W)
RFM08U9X	PW-X	UHF/VHF Professional radios	36	20	5	7.5	9.6	520	0.5
2SK3075	PW-X		30	20	5	7.5	9.6	520	0.5
2SK3074	PW-MINI		30	3	1	0.63	9.6	520	0.02
RFM12U7X	PW-X		20	20	4	11.5	7.2	520	1.0
RFM01U7P *	PW-MINI		20	3	1	1.0	7.2	520	0.1
2SK3476	PW-X		20	20	3	7.0	7.2	520	0.5
2SK3475	PW-MINI		20	3	1	0.63	7.2	520	0.02
RFM04U6P *	PW-MINI	GMRS	16	7	2	3.5	6.0	470	0.2
2SK4037	PW-X		12	20	3	3.55	6.0	470	0.3
2SK2854	PW-MINI	UHF/VHF Professional radios	10	0.5	0.5	0.2	6.0	849	0.02
2SK3079A	PW-X	FRS/GMRS	10	20	3	2.24	4.5	470	0.1
2SK3756	PW-MINI		7.5	3	1	1.26	4.5	470	0.1
2SK3078A	PW-MINI		10	3	0.5	0.63	4.5	470	0.1
2SK3077	USQ	Driver	10	0.25	0.1	0.032	4.8	915	0.001
RFM03U3CT *	RF-CST3	GMRS	16	7	2.5	2.3	3.6	520	0.1
RFM00U7U	USQ	Driver	20	0.25	0.1	0.1	7.2	520	0.01

• Contact the Toshiba sales representative for information about RoHS compliance before you purchase any components.

\*: New product

# IGBTs

## IGBTs (Discrete IGBTs)

Part Number	Applications	Features	Absolute Maximum Ratings (Ta = 25°C)				Package		Circuit Configuration (Note)	VCE(sat) Typ. @Ta = 25°C			If Typ. @Ta = 25°C		Remarks		
			VCES (V)	Ic		Pc				(V)	Ic (A)	VGE (V)	(μs)	Test Conditions			
				DC (A)	Pulsed (A)	Ta = 25°C (W)	Tc = 25°C (W)	Type									
GT30J121	Power supplies (and UPS/PFC/Motor)	High-speed switching	600	30	60	—	170	TO-3P(N)	Through-hole	(1)	2.0	30	15	0.05	Inductive load		
GT30J126				30	60	—	90	TO-3P(N)IS	Isolation, Through-hole	(1)	1.95	30	15	0.05			
GT30J324				30	60	—	170	TO-3P(N)	Through-hole	(2)	2.0	30	15	0.05			
GT50J121				50	100	—	240	TO-3P(LH)	Through-hole	(1)	2.0	50	15	0.05			
GT50J325				50	100	—	240	TO-3P(LH)	Through-hole	(2)	2.0	50	15	0.05			
GT10Q101	Motor drives (and UPS/PFC)	High ruggedness	1200	10	20	—	140	TO-3P(N)	Through-hole	(1)	2.1	10	15	0.16			
GT10Q301				10	20	—	140	TO-3P(N)	Through-hole	(2)	2.1	10	15	0.16			
GT15Q102				15	30	—	170	TO-3P(N)	Through-hole	(1)	2.1	15	15	0.16			
GT15Q301				15	30	—	170	TO-3P(N)	Through-hole	(2)	2.1	15	15	0.16			
GT25Q102				25	50	—	200	TO-3P(LH)	Through-hole	(1)	2.1	25	15	0.16			
GT25Q301		25		50	—	200	TO-3P(LH)	Through-hole	(2)	2.1	25	15	0.16				
GT10J301		High ruggedness				10	20	—	90	TO-3P(N)	Through-hole	(2)	2.1	10		15	0.15
GT20J101						20	40	—	130	TO-3P(N)	Through-hole	(1)	2.1	20		15	0.15
GT20J301						20	40	—	130	TO-3P(N)	Through-hole	(2)	2.1	20		15	0.15
GT30J101						30	60	—	155	TO-3P(N)	Through-hole	(1)	2.1	30		15	0.15
GT30J301	30		60			—	155	TO-3P(N)	Through-hole	(2)	2.1	30	15	0.15			
GT50J102	50		100			—	200	TO-3P(LH)	Through-hole	(1)	2.1	50	15	0.15			
GT30J122	Power factor correction	Low frequency switching		30	100	—	75	TO-3P(N)IS	Isolation, Through-hole	(1)	2.1	50	15	0.25	Resistive load		
GT30J122A				30	100	—	120	TO-3P(N)	Through-hole	(1)	1.7	50	15	0.2			
GT40J121 *				40	100	—	80	TO-3P(N)IS	Isolation, Through-hole	(1)	1.45	40	15	0.2			
GT30J322	IH rice cookers, IH cooktops, Microwave ovens, Induction heating equipment AC 200 V	Current resonance	600	30	100	—	75	TO-3P(N)IS	Isolation, Through-hole	(2)	2.1	50	15	0.25			
GT35J321				37	100	—	75	TO-3P(N)IS	Isolation, Through-hole	(2)	1.9	50	15	0.19			
GT40J321				40	100	—	120	TO-3P(N)	Through-hole	(2)	2.0	40	15	0.11		Fast switching	
GT40J322				40	100	—	120	TO-3P(N)	Through-hole	(2)	1.7	40	15	0.20			
GT40J323				40	100	—	170	TO-3P(N)	Through-hole	(2)	2.0	40	15	0.06		Fast switching	
GT40J325 *				40	100	—	80	TO-3P(N)IS	Isolation, Through-hole	(2)	1.45	40	15	0.2		6th generation	
GT50J322				50	100	—	130	TO-3P(LH)	Through-hole	(2)	2.1	50	15	0.25			
GT50J322H				50	100	—	130	TO-3P(LH)	Through-hole	(2)	2.2	50	15	0.11		Fast switching	
GT50J327				50	100	—	140	TO-3P(N)	Through-hole	(2)	1.9	50	15	0.19			
GT50J341 *				50	100	—	200	TO-3P(N)	Through-hole	(2)	1.6	50	15	0.15		6th generation, Tj = 175°C	
GT50J328				50	120	—	140	TO-3P(N)	Through-hole	(2)	2.0	50	15	0.1		Fast switching	
GT60J321				60	120	—	200	TO-3P(LH)	Through-hole	(2)	1.55	60	15	0.30		Low VCE (sat)	
GT60J323				60	120	—	170	TO-3P(LH)	Through-hole	(2)	1.9	60	15	0.16			
GT60J323H				60	120	—	170	TO-3P(LH)	Through-hole	(2)	2.1	60	15	0.12	Fast switching		

• Contact the Toshiba sales representative for information about RoHS compliance before you purchase any components.

\*: New product

Note)

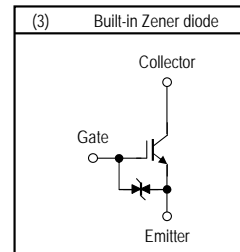
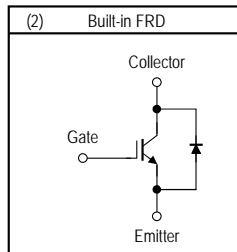
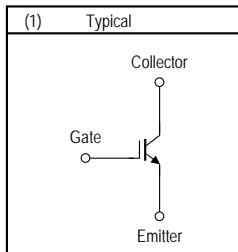

IGBTs (Discrete IGBTs) (Continued)

Part Number	Applications	Features	Absolute Maximum Ratings (Ta = 25°C)				Package		Circuit Configuration (Note)	VCE(sat) Typ. @Ta = 25°C			If Typ. @Ta = 25°C		Remarks	
			VCES (V)	Ic		Pc				(V)	Ic (A)	VGE (V)	(μs)	Test Conditions		
				DC (A)	Pulsed (A)	Ta = 25°C (W)	Tc = 25°C (W)	Type								
GT15M321	IH rice cookers, IH cooktops, Microwave ovens, Induction heating equipment AC100 V	Voltage resonance	900	15	30	—	55	TO-3P(N)IS	Isolation, Through-hole	(2)	1.8	15	15	0.20	For small power	
GT35MR21 *				35	100	—	82	TO-3P(N)IS	Isolation, Through-hole	(2)	1.6	35	15	0.20	6.5th generation	
GT50M322				50	120	—	156	TO-3P(N)	Through-hole	(2)	2.1	60	15	0.25		
GT50MR21 *				50	100	—	230	TO-3P(N)	Through-hole	(2)	1.7	50	15	0.18	6.5th generation, Tj = 175°C	
GT60M324				60	120	—	254	TO-3P(N)	Through-hole	(2)	1.7	60	15	0.11	6th generation, Tj = 175°C	
GT50N322A				50	120	—	156	TO-3P(N)	Through-hole	(2)	2.2	60	15	0.1	Fast switching	
GT50N324				50	120	—	150	TO-3P(N)	Through-hole	(2)	1.9	60	15	0.11	6th generation	
GT60N321				60	120	—	170	TO-3P(LH)	Through-hole	(2)	2.3	60	15	0.25		
GT50NR21 *				1050	50	100	—	230	TO-3P(N)	Through-hole	(2)	1.8	50	15	0.2	6.5th generation Tj = 175°C
GT40QR21 *				1200	40	80	—	230	TO-3P(N)	Through-hole	(2)	1.9	40	15	0.2	6.5th generation, Tj = 175°C
GT40T321 *	1500	40	80	—	230	TO-3P(N)	Through-hole	(2)	2.15	40	15	0.24	6th generation, Tj = 175°C			
GT5G133 *	Digital still cameras, cell phone	Strobe flash (dimming control)	400	—	130	0.83	—	TSON-8	SMD	(3)	3.0	130	2.5	1.5	ICP = 130 A @VGE = 2.5V gate drive	
GT8G151 *	—			150	0.83	—	TSON-8	SMD	(3)	2.65	150	2.5	1.5	ICP = 150 A @VGE = 2.5V gate drive		
GT8G132	Digital still cameras, single lens reflex cameras			—	150	1.1	—	SOP-8	SMD	(3)	2.3	150	4.0	1.6	ICP = 150 A @VGE = 2.5V gate drive	
GT10G131	—			200	1.9	—	SOP-8	SMD	(3)	2.3	200	4.0	1.8	ICP = 200 A @VGE = 4.0V gate drive		
GT30F124	PDP-TV	PDP sustain, energy recovery and separation circuits	300	—	200	—	25	TO-220SIS	Isolation, Through-hole	(1)	2.3	120	15	0.15	6th generation	
GT45F127				—	200	—	26	TO-220SIS	Isolation, Through-hole	(1)	1.6	120	15	0.27	6th generation	
GT30F125 *				330	—	200	—	25	TO-220SIS	Isolation, Through-hole	(1)	1.9	120	15	0.15	6th generation
GT45F128 *				330	—	200	—	26	TO-220SIS	Isolation, Through-hole	(1)	1.45	120	15	0.27	6th generation
GT30F131 *				360	—	200	—	140	TO-220SM (MXN)	SMD	(1)	1.9	120	15	0.17	6th generation
GT30G124				—	200	—	25	TO-220SIS	Isolation, Through-hole	(1)	2.5	120	15	0.23	6th generation	
GT30G125 *				—	200	—	25	TO-220SIS	Isolation, Through-hole	(1)	2.1	120	15	0.16	6th generation	
GT45G127				—	200	—	26	TO-220SIS	Isolation, Through-hole	(1)	1.7	120	15	0.37	6th generation	
GT45G128 *				—	200	—	26	TO-220SIS	Isolation, Through-hole	(1)	1.55	120	15	0.41	6th generation	
GT30J124				600	—	200	—	26	TO-220SIS	Isolation, Through-hole	(1)	2.4	120	15	0.25	5th generation

• Contact the Toshiba sales representative for information about RoHS compliance before you purchase any components.

\*: New product

Note)

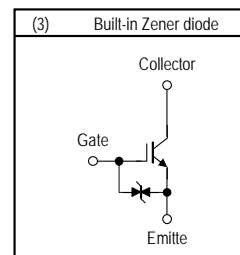
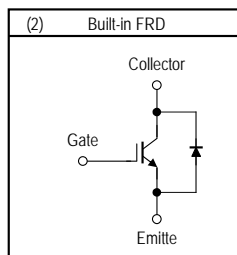
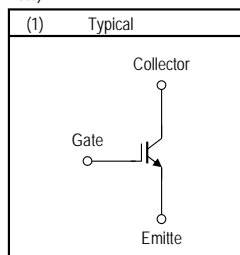

## Phototransistors

Part Number	Part Number with Rank	Package	Electrical/Optical Characteristics (Ta = 25°C)								Applications
			Light Current			Dark Current		Peak Sensitive Wavelength (nm)	Half-Value Angle (°)	Impermeable to Visible Light	
			Min (μA)	Max (μA)	E (mW/cm <sup>2</sup> )	Max (μA)	V <sub>CE</sub> (V)				
TPS601A(F)	—	TO-18CAN with lens	100	—	0.1	0.2	30	800	±10	—	
	TPS601A(A,F)		100	300							
	TPS601A(B,F)		200	600							
	TPS601A(C,F)		400	1200							
TPS610(F)	—	φ5	100	—	0.1	0.1	24	800	±8	—	
TPS611(F)	—	φ5	30	—	0.1	0.1	24	900	±8	●	
TPS615(F)	—	φ3	20	150	0.1	0.1	24	800	±30	—	
	TPS615(B,F)		34	85							
	TPS615(C,F)		60	150							
	TPS615(BC,F)		34	150							
TPS616(F)	—	φ3	10	75	0.1	0.1	24	900	±30	●	
	TPS616(B,F)		17	42.5							
	TPS616(C,F)		30	75							
	TPS616(BC,F)		17	75							
TPS622(F)	—	Small side-view package	27	—	0.1	0.1	24	870	±15	●	
	TPS622(A,F)		27	80							
	TPS622(B,F)		55	165							

Note: E = radiant incidence; V<sub>CE</sub> = collector-emitter voltage

- Contact the Toshiba sales representative for information about RoHS compliance before you purchase any components.

**Toshiba America****Electronic Components, Inc.**

- Irvine, Headquarters  
Tel: (949)623-2900 Fax: (949)474-1330
- Buffalo Grove (Chicago)  
Tel: (847)484-2400 Fax: (847)541-7287
- Duluth/Atlanta  
Tel: (770)931-3363 Fax: (770)931-7602
- El Paso  
Tel: (915)771-8156
- Marlborough  
Tel: (508)481-0034 Fax: (508)481-8828
- Parsippany  
Tel: (973)541-4715 Fax: (973)541-4716
- San Jose  
Tel: (408)526-2400 Fax: (408)526-2410
- Wixom (Detroit)  
Tel: (248)347-2607 Fax: (248)347-2602
- Bloomington  
Tel: (952)842-2400 Fax: (952)893-8031
- San Diego  
Tel: (858)385-5900 Fax: (858)674-7606

**Toshiba Electronics do Brasil Ltda.**

Tel: (011)2539-6681 Fax: (011)2539-6675

**Toshiba Electronics Europe GmbH**

- Düsseldorf Head Office  
Tel: (0211)5296-0 Fax: (0211)5296-400
- France Branch  
Tel: (1)47282181
- Italy Branch  
Tel: (039)68701 Fax: (039)6870205
- Spain Branch  
Tel: (91)660-6798 Fax: (91)660-6799
- U.K. Branch  
Tel: (0870)060-2370 Fax: (01252)53-0250
- Sweden Branch  
Tel: (08)704-0900 Fax: (08)80-8459

**Toshiba Electronics Asia (Singapore) Pte. Ltd.**

Tel: (6278)5252 Fax: (6271)5155

**Toshiba Electronics Service (Thailand) Co., Ltd.**

Tel: (02)501-1635 Fax: (02)501-1638

**Toshiba Electronics Trading (Malaysia) Sdn. Bhd.**

- Kuala Lumpur Head Office  
Tel: (03)5631-6311 Fax: (03)5631-6307
- Penang Office  
Tel: (04)226-8523 Fax: (04)226-8515

**Toshiba India Private Ltd.**

Tel: (0124)499-6600 Fax: (0124)499-6611

**Toshiba Electronics Asia, Ltd.**

- Hong Kong Head Office  
Tel: 2375-6111 Fax: 2375-0969
- Beijing Office  
Tel: (010)6590-8796 Fax: (010)6590-8791
- Chengdu Office  
Tel: (028)8675-1773 Fax: (028)8675-1065
- Qingdao Office  
Tel: (532)8579-3328 Fax: (532)8579-3329

**Toshiba Electronics (Shenzhen) Co., Ltd**

Tel: (0755)2399-6897 Fax: (0755)2399-5573

**Toshiba Electronics (Shanghai) Co., Ltd.**

- Shanghai PUXI Branch  
Tel: (021)6139-3888 Fax: (021)6190-8288
- Hangzhou Office  
Tel: (0571)8717-5004 Fax: (0571)8717-5013
- Nanjing Office  
Tel: (025)8689-0070 Fax: (025)8689-0070

**Toshiba Electronics (Dalian) Co., Ltd.**

Tel: (0411)8368-6882 Fax: (0411)8369-0822

**Tsurong Xiamen Xiangyu Trading Co., Ltd.**

Tel: (0592)226-1398 Fax: (0592)226-1399

**Toshiba Electronics Korea Corporation**

- Seoul Head Office  
Tel: (02)3484-4334 Fax: (02)3484-4302
- Daegu Office  
Tel: (053)428-7610 Fax: (053)428-7617

**Toshiba Electronics Taiwan Corporation**

- Taipei Head Office  
Tel: (02)2508-9988 Fax: (02)2508-9999

- ▶ Toshiba Corporation, and its subsidiaries and affiliates (collectively "TOSHIBA"), reserve the right to make changes to the information in this document, and related hardware, software and systems (collectively "Product") without notice.
  - ▶ This document and any information herein may not be reproduced without prior written permission from TOSHIBA. Even with TOSHIBA's written permission, reproduction is permissible only if reproduction is without alteration/omission.
  - ▶ Though TOSHIBA works continually to improve Product's quality and reliability, Product can malfunction or fail. Customers are responsible for complying with safety standards and for providing adequate designs and safeguards for their hardware, software and systems which minimize risk and avoid situations in which a malfunction or failure of Product could cause loss of human life, bodily injury or damage to property, including data loss or corruption. Before customers use the Product, create designs including the Product, or incorporate the Product into their own applications, customers must also refer to and comply with (a) the latest versions of all relevant TOSHIBA information, including without limitation, this document, the specifications, the data sheets and application notes for Product and the precautions and conditions set forth in the "TOSHIBA Semiconductor Reliability Handbook" and (b) the instructions for the application with which the Product will be used with or for. Customers are solely responsible for all aspects of their own product design or applications, including but not limited to (a) determining the appropriateness of the use of this Product in such design or applications; (b) evaluating and determining the applicability of any information contained in this document, or in charts, diagrams, programs, algorithms, sample application circuits, or any other referenced documents; and (c) validating all operating parameters for such designs and applications. **TOSHIBA ASSUMES NO LIABILITY FOR CUSTOMERS' PRODUCT DESIGN OR APPLICATIONS.**
  - ▶ Product is intended for use in general electronics applications (e.g., computers, personal equipment, office equipment, measuring equipment, industrial robots and home electronics appliances) or for specific applications as expressly stated in this document. Product is neither intended nor warranted for use in equipment or systems that require extraordinarily high levels of quality and/or reliability and/or a malfunction or failure of which may cause loss of human life, bodily injury, serious property damage or serious public impact ("Unintended Use"). Unintended Use includes, without limitation, equipment used in nuclear facilities, equipment used in the aerospace industry, medical equipment, equipment used for automobiles, trains, ships and other transportation, traffic signaling equipment, equipment used to control combustions or explosions, safety devices, elevators and escalators, devices related to electric power, and equipment used in finance-related fields. Do not use Product for Unintended Use unless specifically permitted in this document.
  - ▶ Do not disassemble, analyze, reverse-engineer, alter, modify, translate or copy Product, whether in whole or in part.
  - ▶ Product shall not be used for or incorporated into any products or systems whose manufacture, use, or sale is prohibited under any applicable laws or regulations.
  - ▶ The information contained herein is presented only as guidance for Product use. No responsibility is assumed by TOSHIBA for any infringement of patents or any other intellectual property rights of third parties that may result from the use of Product. No license to any intellectual property right is granted by this document, whether express or implied, by estoppel or otherwise.
  - ▶ **ABSENT A WRITTEN SIGNED AGREEMENT, EXCEPT AS PROVIDED IN THE RELEVANT TERMS AND CONDITIONS OF SALE FOR PRODUCT, AND TO THE MAXIMUM EXTENT ALLOWABLE BY LAW, TOSHIBA (1) ASSUMES NO LIABILITY WHATSOEVER, INCLUDING WITHOUT LIMITATION, INDIRECT, CONSEQUENTIAL, SPECIAL, OR INCIDENTAL DAMAGES OR LOSS, INCLUDING WITHOUT LIMITATION, LOSS OF PROFITS, LOSS OF OPPORTUNITIES, BUSINESS INTERRUPTION AND LOSS OF DATA, AND (2) DISCLAIMS ANY AND ALL EXPRESS OR IMPLIED WARRANTIES AND CONDITIONS RELATED TO SALE, USE OF PRODUCT, OR INFORMATION, INCLUDING WARRANTIES OR CONDITIONS OF MERCHANTABILITY, FITNESS FOR A PARTICULAR PURPOSE, ACCURACY OF INFORMATION, OR NONINFRINGEMENT.**
  - ▶ Product may include products using GaAs (Gallium Arsenide). GaAs is harmful to humans if consumed or absorbed, whether in the form of dust or vapor. Handle with care and do not break, cut, crush, grind, dissolve chemically or otherwise expose GaAs in Product.
  - ▶ Do not use or otherwise make available Product or related software or technology for any military purposes, including without limitation, for the design, development, use, stockpiling or manufacturing of nuclear, chemical, or biological weapons or missile technology products (mass destruction weapons). Product and related software and technology may be controlled under the Japanese Foreign Exchange and Foreign Trade Law and the U.S. Export Administration Regulations. Export and re-export of Product or related software or technology are strictly prohibited except in compliance with all applicable export laws and regulations.
  - ▶ Product may include products subject to foreign exchange and foreign trade control laws.
  - ▶ Please contact your TOSHIBA sales representative for details as to environmental matters such as the RoHS compatibility of Product. Please use Product in compliance with all applicable laws and regulations that regulate the inclusion or use of controlled substances, including without limitation, the EU RoHS Directive. TOSHIBA assumes no liability for damages or losses occurring as a result of noncompliance with applicable laws and regulations.
- In addition to the above, the following are applicable only to development tools.
- ▶ Though TOSHIBA works continually to improve Product's quality and reliability, Product can malfunction or fail. Use the Product in a way which minimizes risk and avoid situations in which a malfunction or failure of Product could cause loss of human life, bodily injury or damage to property, including data loss or corruption. For using the Product, customers must also refer to and comply with the latest versions of all relevant TOSHIBA information, including without limitation, this document, the instruction manual, the specifications, the data sheets for Product.
  - ▶ Product is provided solely for the purpose of performing the functional evaluation of a semiconductor product. Please do not use Product for any other purpose, including without limitation, evaluation in high or low temperature or humidity, and verification of reliability.
  - ▶ Do not incorporate Product into your products or system. Products are for your own use and not for sale, lease or other transfer.

**TOSHIBA**