

## LM1950 750 mA High Side Switch

### General Description

The LM1950 is a high current, high side (PNP) power switch for driving ground referenced loads. Intended for industrial and automotive applications the LM1950 is guaranteed to deliver 750 mA continuous load current (with typically 1.4 Amps peak) and can withstand supply voltage transients up to +60V and -50V. When switched OFF the quiescent current drain from the input power supply is less than 100  $\mu\text{A}$  which can allow continuous connection to a battery power source.

The LM1950 will drive all types of resistive or reactive loads. To obtain a rapid decay time of the energy in inductive loads, the output is internally protected but not clamped and can swing below ground to at least 54V negative with respect to the input power supply voltage.

The ON/OFF input can be driven with standard 5V TTL or CMOS compatible logic levels independent of the  $V_{CC}$  supply voltage used. Built in protection features include short circuit protection, thermal shutdown, over-voltage shutdown to protect load circuits and protection against reverse polarity input connections. The LM1950 is available in a 5-lead power TO-220 package and specified over a wide -40°C to 125°C operating temperature range.

### Features

- 750 mA continuous output drive current
- Less than 100  $\mu\text{A}$  quiescent current in OFF state
- Low input/output voltage drop
- +60V/-50V transient protection
- Drives resistive or reactive loads
- Unclamped output for fast inductive decay times
- Reverse battery protected
- Short circuit proof
- Overvoltage shutdown to protect loads
- TTL/CMOS compatible control input
- Thermal overload protection

### Applications

- Relay driver
- Solenoid/Valve driver
- Lamp driver
- Load circuit switching
- Motor driver

### Typical Application

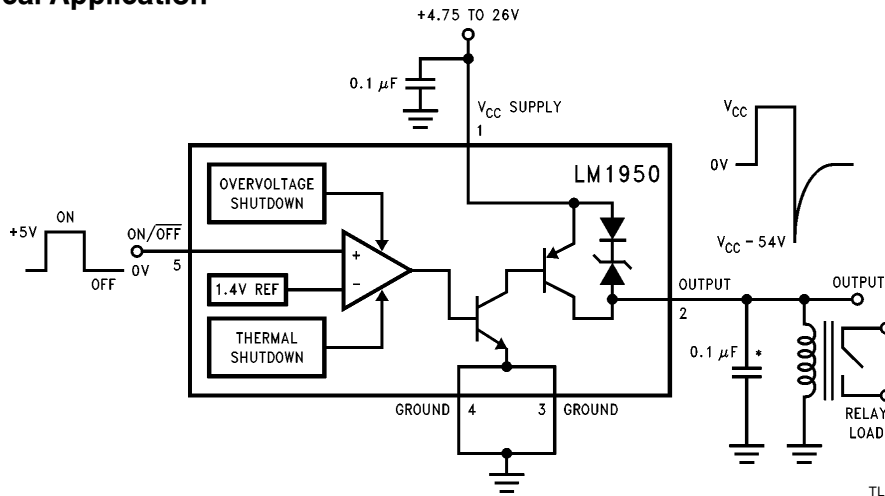

TL/H/11237-1

\*Required for stability

### Connection Diagram

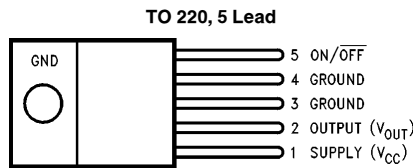

TL/H/11237-2

Front View  
Order Number LM1950T  
See NS Package Number T05A

## Absolute Maximum Ratings (Note 1)

If Military/Aerospace specified devices are required, please contact the National Semiconductor Sales Office/Distributors for availability and specifications.

Supply Voltage	
Continuous	26V
Transient ( $\tau \leq 100$ ms)	-50V to +60V
Reverse Polarity (continuous)	-15V
On/Off Voltage	-0.3V to +6.0V
Power Dissipation	Internally Limited
Load Inductance	150 mH
Maximum Junction Temperature	150°C

Storage Temperature Range	-65°C to +150°C
Lead Temperature (Soldering, 10 seconds)	230°C
ESD Susceptibility (Note 2)	2000V

## Operating Ratings (Note 1)

Temperature Range ( $T_A$ )	-40°C to +125°C
Supply Voltage Range	4.75V to 26V
Thermal Resistances:	
Junction to Case ( $\theta_{j-c}$ )	3°C/W
Case to Ambient ( $\theta_{c-a}$ )	50°C/W

## Electrical Characteristics

$V_{CC} = 14V$ ,  $I_{OUT} = 150$  mA unless otherwise indicated. **Boldface** limits apply over the entire operating temperature range,  $-40^\circ\text{C} \leq T_A \leq 125^\circ\text{C}$ , all other specifications are for  $T_A = T_J = 25^\circ\text{C}$

Parameter	Conditions	Typical	Limit	Units (Limit)
Supply Voltage				
Operational			4.75/ <b>4.75</b>	V (Min)
Survival			26/ <b>26</b>	V (Max)
Transient	$t = 1$ ms, $\tau = 100$ ms, 1% dutycycle		-15/ <b>-15</b>	$V_{DC}$ (Min)
			60/ <b>60</b>	V (Max)
			-50/ <b>-50</b>	V (Min)
Supply Current	$V_{ON/OFF} = 0.8V$ $V_{ON/OFF} = 2.0V$ $I_{OUT} = 0$ mA $I_{OUT} = 250$ mA $I_{OUT} = 500$ mA $I_{OUT} = 750$ mA	20 5 275 550 825	100/ <b>100</b> 10/ <b>10</b> 350/ <b>350</b> 700/ <b>700</b> 950/ <b>950</b>	$\mu\text{A}$ (Max) mA (Max) mA (Max) mA (Max) mA (Max)
Input to Output Voltage Drop	$I_{OUT} = 250$ mA $I_{OUT} = 500$ mA $I_{OUT} = 750$ mA	0.30 0.50 0.75	0.5/ <b>0.6</b> 0.7/ <b>1.0</b> 1.1/ <b>1.4</b>	V (Max) V (Max) V (Max)
Short Circuit Current		1.5	1.0/ <b>0.75</b> 2.0/ <b>2.0</b>	A (Min) A (Max)
Output Leakage Current	$V_{ON/OFF} = 0.8V$	10	50/ <b>50</b>	$\mu\text{A}$ (Max)
ON/OFF Input Threshold Voltage		1.4	0.8/ <b>0.8</b> 2.0/ <b>2.0</b>	V (Min) V (Max)
ON/OFF Input Current	$V_{ON/OFF} = 0.8V$ $V_{ON/OFF} = 2.0V$ $V_{ON/OFF} = 5.25V$	0.1 1 50	5/ <b>10</b> 10/ <b>20</b> 100/ <b>100</b>	$\mu\text{A}$ (Max) $\mu\text{A}$ (Max) $\mu\text{A}$ (Max)
Overvoltage Shutdown Threshold		33	27/ <b>27</b> 37/ <b>37</b>	V (Min) V (Max)
Inductive Clamp Output Voltage	$V_{ON/OFF} = 2V$ to 0.8V, $I_{OUT} = 100$ mA	-45	-120/ <b>-120</b> -40/ <b>-40</b>	V (Max) V (Min)
Output Turn-On Delay	$V_{ON/OFF} 0.8V$ to 2V	4.2	<b>20</b>	$\mu\text{s}$
Output Turn-Off Delay	$V_{ON/OFF} 2V$ to 0.8V	4.5	<b>20</b>	$\mu\text{s}$

**Note 1:** Absolute Maximum Ratings indicate limits beyond which damage to the device may occur. Operating Ratings indicate conditions for which the device is intended to be functional, but do not guarantee specific performance limits. For guaranteed specifications and test conditions, see the Electrical Characteristics.

**Note 2:** Human body model, 100 pF discharged through a 1.5 k $\Omega$  resistor.

# Typical Performance Characteristics

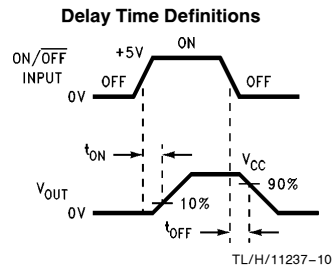
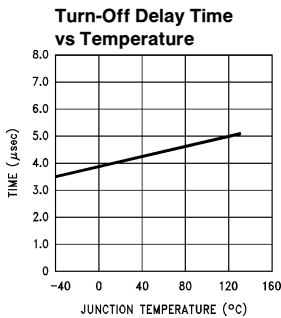
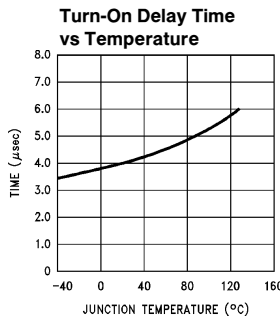
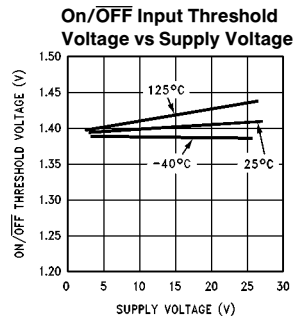
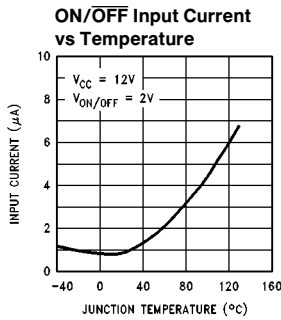
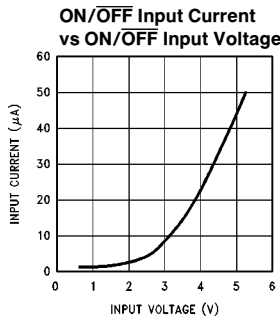
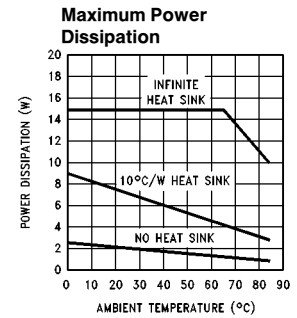
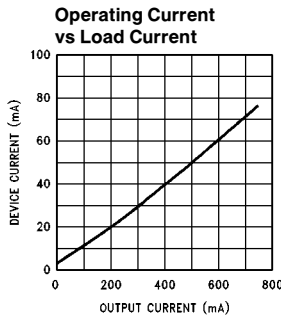
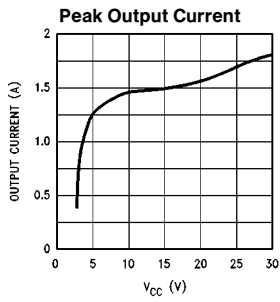
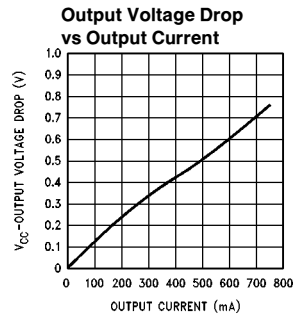
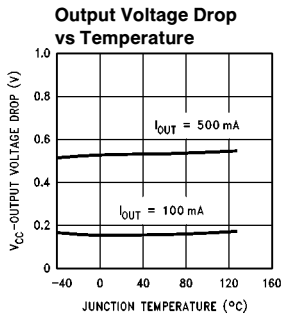
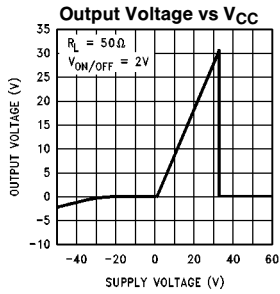

## Application Hints

### HIGH CURRENT OUTPUT

The 750 mA output is fault protected against overvoltage. If the supply voltage rises above approximately 30V, the output will automatically shut down. This protects the internal circuitry and enables the IC to survive higher voltage transients than would otherwise be expected. The LM1950 will survive transients and DC voltages up to 60V on the supply. The output remains off during this time, independent of the state of the input logic voltage. This protects the load. The high current output is also protected against short circuits to either ground or supply voltage. Standard thermal shutdown circuits are employed to protect the LM1950 from overheating.

### FLYBACK RESPONSE

Since the LM1950 is designed to drive inductive as well as any other type of load, inductive kickback can be expected whenever the output changes state from ON to OFF (See Waveform on Figure 1). The driver output was left unclamped since it is often desirable in many systems to achieve a very rapid decay in the load current. In applications where this is not true, such as in Figure 2, a simple external diode clamp will suffice. In this application, the integrated current in the inductive load is controlled by varying the duty cycle of the input to the drive IC. This technique achieves response characteristics that are desirable for certain automotive transmission solenoids, for example.

For applications requiring a rapid controlled decay in the solenoid current, such as fuel injector drivers, an external zener and diode can be used as in Figure 3. The voltage rating of the zener clamp should be such that it breaks down before the output of the LM1950. The minimum output breakdown voltage of the IC output is rated at -54V with respect to the supply voltage.

The LM1950 can be used alone as a simple relay or solenoid driver where a rapid decay of the load current is desired, but the exact rate of decay is not critical to the system. If the output is unclamped as in Figure 1, and the load is inductive enough, the negative flyback transient will cause the output of the IC to breakdown and behave similarly to a zener clamp. Relying upon the IC breakdown is practical and will not damage or degrade the IC in any way. There are two considerations that must be accounted for when the driver is operated in this mode. The IC breakdown voltage is process and lot dependent. Output clamp voltages ranging from -40V to -120V (with V<sub>CC</sub> supply of 14V) will be encountered over time on different devices. This is not at all critical in most applications. An important consideration, however, is the additional heat dissipated in the IC as a result. This must be added to normal device dissipation when considering junction temperatures and heat sinking requirements. Worst case for the additional dissipation can be approximated as:

$$\text{Additional } P_D = I^2 \times L \times f \text{ (Watts)}$$

Where: I = Peak Solenoid Current (Amps)

L = Solenoid Inductance (Henries)

f = Maximum Frequency Input Signal (Hz)

For solenoids where the inductance is less than ten millihenries, the additional power dissipation can be ignored. Overshoot, undershoot, and ringing can occur on certain loads. The simple solution is to lower the Q of the load by the addition of a resistor in parallel or series with the load. A value that draws one tenth of the current or DC voltage of the load is usually sufficient.

For frequency stability of the switch, a 0.1 μF or larger output bypass capacitor is required.

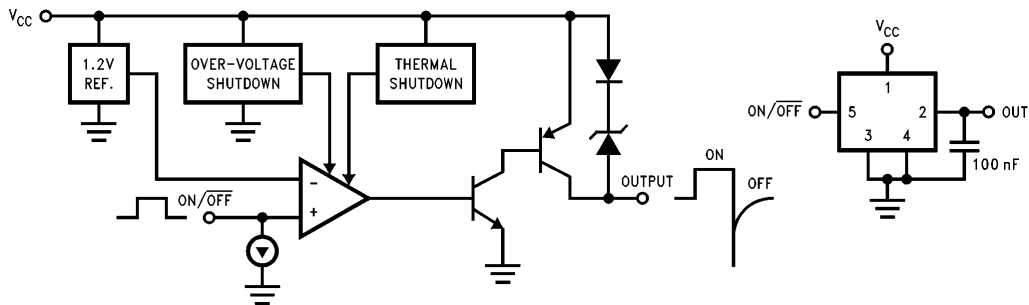

FIGURE 1

TL/H/11237-4

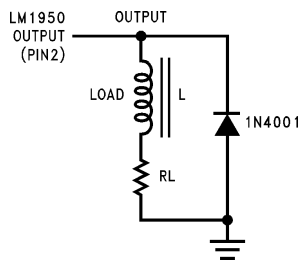

FIGURE 2. Diode Clamp

TL/H/11237-5

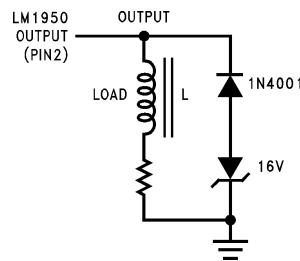
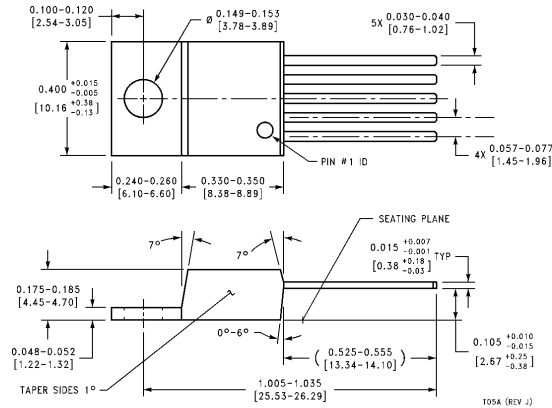

FIGURE 3. Zener Clamp for Rapid Controlled Current Decay

TL/H/11237-6



**Physical Dimensions** inches (millimeters)



**Order Number LM1950T  
NS Package Number T05A**

**LIFE SUPPORT POLICY**

NATIONAL'S PRODUCTS ARE NOT AUTHORIZED FOR USE AS CRITICAL COMPONENTS IN LIFE SUPPORT DEVICES OR SYSTEMS WITHOUT THE EXPRESS WRITTEN APPROVAL OF THE PRESIDENT OF NATIONAL SEMICONDUCTOR CORPORATION. As used herein:

1. Life support devices or systems are devices or systems which, (a) are intended for surgical implant into the body, or (b) support or sustain life, and whose failure to perform, when properly used in accordance with instructions for use provided in the labeling, can be reasonably expected to result in a significant injury to the user.
2. A critical component is any component of a life support device or system whose failure to perform can be reasonably expected to cause the failure of the life support device or system, or to affect its safety or effectiveness.



**National Semiconductor Corporation**  
1111 West Bardin Road  
Arlington, TX 76017  
Tel: 1(800) 272-9959  
Fax: 1(800) 737-7018

**National Semiconductor Europe**  
Fax: (+49) 0-180-530 85 86  
Email: cnjwge@tevm2.nsc.com  
Deutsch Tel: (+49) 0-180-530 85 85  
English Tel: (+49) 0-180-532 78 32  
Français Tel: (+49) 0-180-532 93 58  
Italiano Tel: (+49) 0-180-534 16 80

**National Semiconductor Hong Kong Ltd.**  
19th Floor, Straight Block,  
Ocean Centre, 5 Canton Rd.  
Tsimshatsui, Kowloon  
Hong Kong  
Tel: (852) 2737-1600  
Fax: (852) 2736-9960

**National Semiconductor Japan Ltd.**  
Tel: 81-043-299-2309  
Fax: 81-043-299-2408

National does not assume any responsibility for use of any circuitry described, no circuit patent licenses are implied and National reserves the right at any time without notice to change said circuitry and specifications.