

5-V Low-Drop Voltage Regulator

TLE 4258

Preliminary Data

Bipolar IC

Features

- Low-drop voltage
- Low quiescent current
- Reset output
- Protection against reverse polarity
- Overvoltage protection 70 V
- Short-circuit proof
- Suited for automotive electronics
- Inhibit input
- Wide temperature range

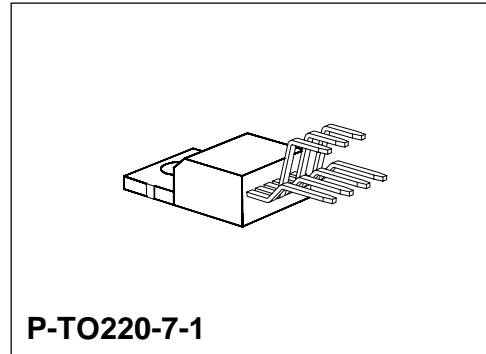

Type	Ordering Code	Package
TLE 4258	Q67000-A8238	P-TO220-7-1

The TLE 4258 is a very low drop voltage regulator which provides two regulated 5-V output voltages. The main regulator can be loaded with 750 mA and is turned on and off by pin 5 (pin 5 unconnected = main regulator off). In addition, the main regulator incorporates a short-circuit current limitation and is turned off in case of overvoltage ($V_I > V_{I\text{OFF}}$). The standby regulator can be loaded with 35 mA, it does not incorporate a short-circuit current limitation and remains permanently active at positive input voltage independent of the turn-off functions of the main regulator.

If the main regulator output voltage is less than 4.5 V, the reset output is switched to low without delay. As soon as the reset threshold has been exceeded, a delay time to be set by an external capacitor expires and afterwards the reset output switches to high again.

If the lines to the controller are long, the oscillating circuit of line inductance and input capacitance C_I can be attenuated by a resistor $\leq 1 \Omega$ connected in series to C_I .

Circuit Description

The TLE 4258 incorporates a main and standby-control regulator: The amplifiers regulate the output voltage by comparing the output voltage (from the voltage divider) with a highly precise reference voltage. The standby regulator directly controls the base of a PNP series transistor and the main regulator via a buffer that can be turned off with inhibit pulse at pin 5. If the output voltage V_O at pin 7 drops below 4.5 V, a reset signal is released which can only be disabled after a delay time to be set at pin 6. The main output is current-limited and remains active up to the input voltage $V_{I\text{OFF}}$.

Pin Configuration (top view)

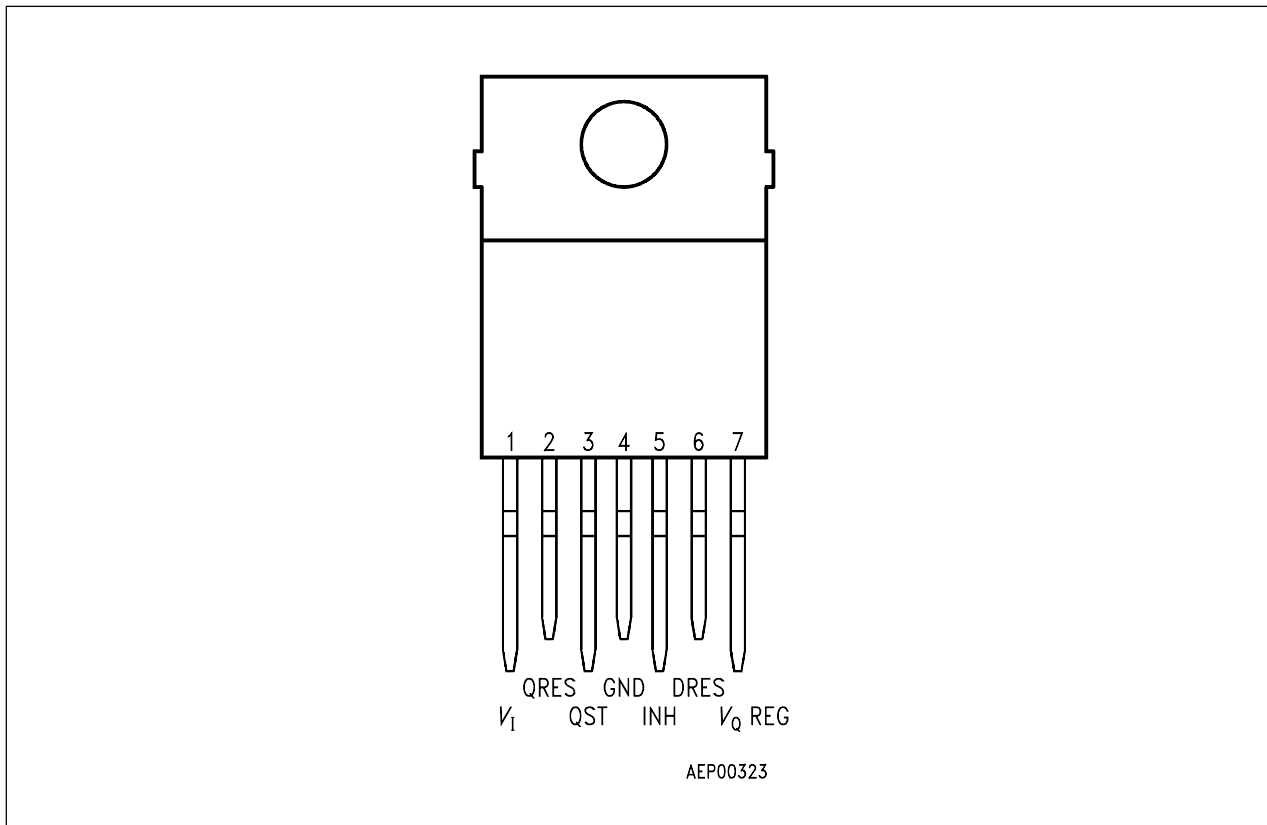

Pin Definitions and Functions

Pin	Symbol	Function
1	V_i	Input of voltage regulator
2	Q RES	Reset output ; open-collector output NPN to pin 4. If the output voltage V_o drops below the reset threshold, the output stage becomes conductive.
3	Q ST	Standby output , connect with a capacitor $\geq 10 \mu\text{F}$
4	GND	Ground ; reference potential
5	INH	Inhibit (main regulator ON/OFF) , input for turning on/off main regulator, connected to a 22-k Ω series resistor. With open input, the main regulator remains turned off.
6	D RES	Reset delay ; pin for reset capacitor; the size of this capacitor determines the delay time of the reset signal typ. 175 ms/ μF .
7	V_o REG	Main regulator output , connected to a capacitor $\geq 22 \mu\text{F}$.

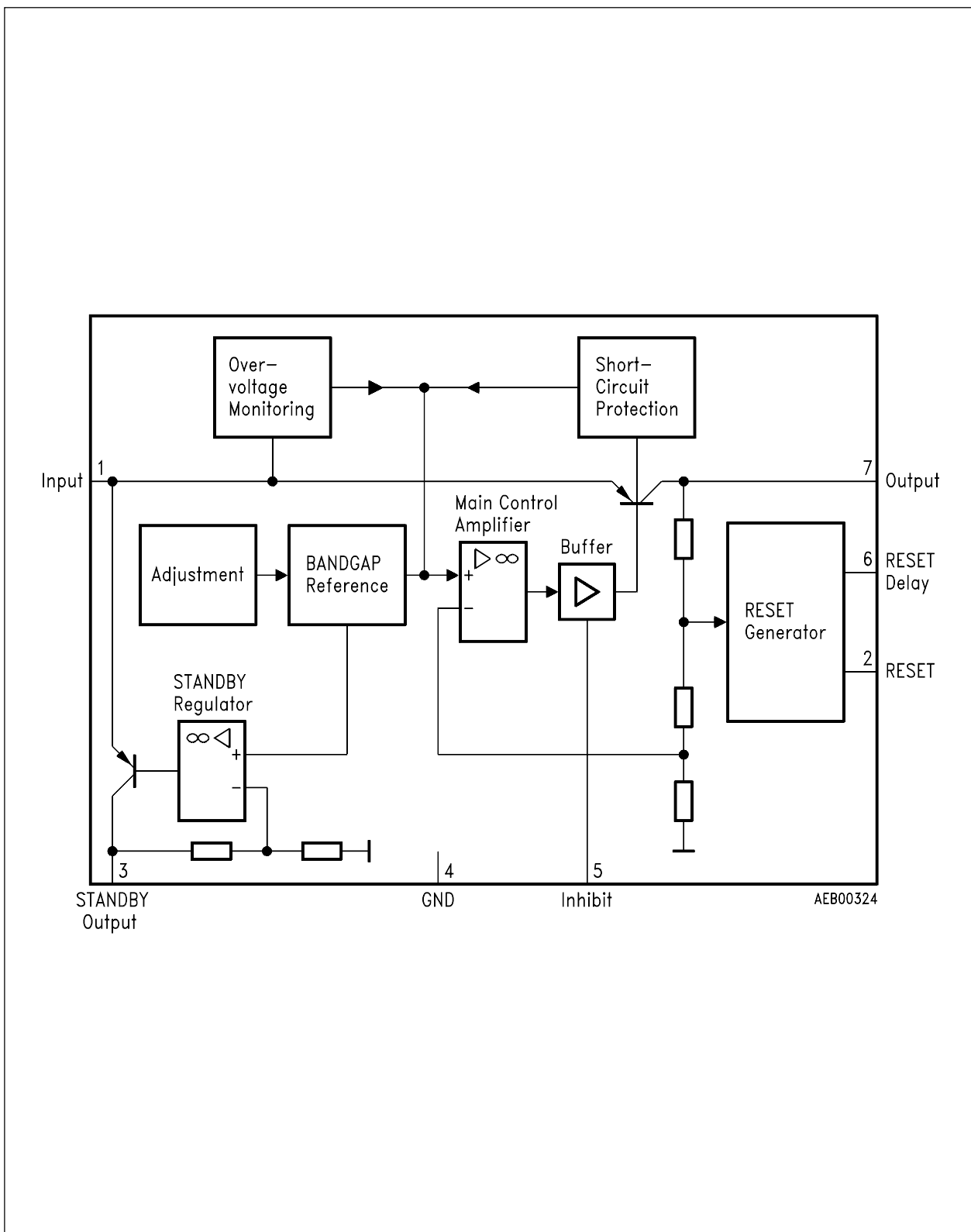

Block Diagram

Absolute Maximum Ratings

$T_A = -40$ to 150 °C

Parameter	Symbol	Limit Values		Unit
		min.	max.	

Input (Pin 1)

Supply voltage	V_I	- 15	36	V
Polarity reversal with test pulse $t_2 \leq 100$ ms see test circuit	V_I	- 70	-	V
Load-dump with pulse shape $t_2 \leq 400$ ms see test circuit	V_I	-	- 70	V -
Slew rate $0 \text{ V} \leq V_I \leq 24 \text{ V}$	SR	-	100	V/ μ s
Slew rate $24 \text{ V} \leq V_I \leq 70 \text{ V}$	SR	-	10	V/ μ s
Current	I_I	-	2.5	A

Reset Output (Pin 2)

Voltage	V_R	-	8	V
Current	I_R	-	10	mA

Standby Output (Pin 3)

Voltage	V_{ST}	-	6	V
Current	I_{ST}	-	50	mA

Ground (Pin 4)

Current	I_{GND}	-	1.8	A
Inhibit (main regulator on/off), (Pin 5) Current	I_{INH}	-	± 7.5	mA
Reset delay (Pin 6) Voltage	V_C	-	V_Q	V
Main regulator output (Pin 7) Voltage $V_I \geq V_Q$	V_Q	-	18	V
Current	I_Q	-	1.8	A

Temperature

Junction temperature	T_j	-	150	°C
Storage temperature	T_{stg}	- 50	150	°C

Operating Range

Input voltage	V_I	6	24	V
Junction temperature	T_j	- 40	150	°C
Thermal resistance	system – air system – case	$R_{th SA}$ $R_{th SC}$	- -	65 4 K/W K/W

Characteristics

$V_I = 13.5 \text{ V}$; $T_j = 25 \text{ }^\circ\text{C}$; $V_S > 3.5 \text{ V}$ (unless otherwise specified)

Parameter	Symbol	Limit Values			Unit	Test Condition
		min.	typ.	max.		

Main Regulator

Output voltage	V_Q	4.85	–	5.15	V	$0 \text{ mA} \leq I_Q \leq 750 \text{ mA}$ $6 \text{ V} < V_I < V_{I\text{off}}$ $-40 \text{ }^\circ\text{C} \leq T_j \leq 125 \text{ }^\circ\text{C}$
Input current	I_Q	–	–	30	mA	$I_Q = 0 \text{ mA}$; $I_{ST} = 0 \text{ mA}$
Current consumption without load	I_Q	–	–	150	mA	$I_Q = 450 \text{ mA}$; $I_{ST} = 0 \text{ mA}$
	I_Q	–	–	300	mA	$I_Q = 750 \text{ mA}$; $I_{ST} = 0 \text{ mA}$
	I_Q	–	–	300	mA	$V_I = 5.8 \text{ V}$; $I_Q = 750 \text{ mA}$; $I_{ST} = 0 \text{ mA}$
	I_Q	–	–	300	mA	
Turn-OFF voltage	$V_{I\text{OFF}}$	25	–	–	V	$V_I > V_{I\text{off}}$
Output current	I_Q	–	–	20	mA	$V_I > V_{I\text{off}}$
Short-circuit current	I_{SC}	0.75	1	1.8	A	$V_Q = 0 \text{ V}$; $6 \text{ V} \leq V_I < 13.5 \text{ V}$
Drop voltage	V_{Dr}	–	0.3	0.5	V	$V_I = 4.5 \text{ V}$; $I_Q = 450 \text{ mA}$
	V_{Dr}	–	0.5	0.75	V	$V_I = 4.5 \text{ V}$; $I_Q = 750 \text{ mA}$
Static load regulation	$\Delta V_Q / \Delta I_Q$	–	–	0.2	Ω	$6 \text{ V} \leq V_I \leq 16 \text{ V}$ $0 \text{ mA} \leq -I_Q \leq 750 \text{ mA}$
Dynamic load regulation	ΔV_Q	–	–	150	mV	$I_Q = 75 \text{ mA}$ of $I_Q = 750 \text{ mA}$ $C_Q \geq 50 \text{ } \mu\text{F}$
Supply voltage-rejection	α_{SVR}	60	–	–	dB	$I_Q = 750 \text{ mA}$; $V_I = 12 \text{ V} + 1 \text{ V} \cos(2\pi \times 120 \text{ Hz} \times t)$; $\alpha_{SVR} = 20 \log(1 \text{ V} / \Delta V_Q)$
Reverse output current	$-I_{QR}$	–	5	30	mA	$V_I = 0$; $0 \text{ V} \leq V_Q \leq 4.85 \text{ V}$
Temperature drift of output voltage	α_{VQ}	–0.5	–	0.5	mV/K	$6 \text{ V} \leq V_I \leq V_{I\text{off}}$ $\Delta T_j > 50 \text{ K}$

Reset Generator

Switching threshold	V_{RT}	4.4	4.5	4.6	V	–
Switching voltage	V_R			0.8	V	$V_Q < V_{RT}$; $I_R = 10 \text{ mA}$
	V_R	4.4	–	V_Q	V	$V_Q > V_{RT}$
Reverse current	I_R	–	–	5	μA	$V_R > 4.6 \text{ V}$;
Change current	I_{ch}	10	–	30	μA	$0.5 \text{ V} < V_{Cd} < (0.75 \times V_Q)$
Reset delay time	$t_{D/Cd}$	–	175	–	ms/ μF	–

Characteristics (cont'd)

$V_i = 13.5 \text{ V}$; $T_j = 25 \text{ }^\circ\text{C}$; $V_5 > 3.5 \text{ V}$ (unless otherwise specified)

Parameter	Symbol	Limit Values			Unit	Test Condition
		min.	typ.	max.		
Standby regulator	–	–	–	–	–	$V_5 \leq 0.5 \text{ V}$
Output voltage	V_{ST}	4.7	–	5.3	V	$0 \text{ mA} \leq I_{ST} \leq 35 \text{ mA}$ $6 \text{ V} \leq V_i \leq V_{i\text{off}}$
	V_{ST}	4.5	–	6.0	V	$0 \text{ mA} \leq I_{ST} \leq 35 \text{ mA}$ $V_{i\text{off}} \leq V_i \leq 70 \text{ V}$; $t_2 \leq 400 \text{ ms}$
Current consumption without load	I_{QST}	–	–	2	mA	$I_Q = 0 \text{ mA}$; $I_{ST} = 0 \text{ mA}$
	I_{QST}	–	–	15	mA	$I_Q = 0 \text{ mA}$; $I_{ST} = 35 \text{ mA}$
Drop voltage	V_{DrST}	–	–	0.75	V	$V_i = 4.5 \text{ V}$; $I_{ST} = 35 \text{ mA}$
Static load regulation	$\Delta V_{ST}/\Delta I_{ST}$	–	1	–	Ω	$6 \text{ V} \leq V_i < V_{i\text{off}}$ $0 \text{ mA} \leq I_{ST} \leq 35 \text{ mA}$
Supply voltage rejection	α_{SVRST}	60	–	–	dB	$I_{ST} = 35 \text{ mA}$; $V_i = 12 \text{ V} + 1 \text{ V} \times \cos(2\pi \times 120 \text{ Hz} \times t)$
Reverse current	$-I_{ST}$	–	–	2	mA	$V_i = 0 \text{ V}$; $0 \text{ V} \leq V_{ST} \leq 4.7 \text{ V}$

General Ratings

Reverse polarity	$-V_Q$	–	0	0.7	V	$V_i = -15 \text{ V}$
	$-I_Q$	–	0	0.5	mA	$V_i = -15 \text{ V}$
	$-V_{ST}$	–	0	0.7	V	$V_i = -15 \text{ V}$
	$-I_{ST}$	–	0	0.5	mA	$V_i = -15 \text{ V}$
Synchronous operation V_{ST} ; V_Q	$V_{ST} - V_Q$	–200	–	200	mV	$0 \text{ mA} \leq I_{ST} \leq 35 \text{ mA}$ $0 \text{ mA} \leq I_Q \leq 750 \text{ mA}$ $6 \text{ V} \leq V_i < V_{i\text{off}}$
Necessary series resistance	R_5	12	22	24	k Ω	–
Switching threshold for main regulator	V_5	3.5	–	–	V	$V_Q > 3 \text{ V}$; $I_Q = 0.5 \text{ A}$
	V_5	–	–	0.5	V	$V_Q < 3 \text{ V}$; $I_Q = 1 \text{ mA}$
Load impedance	R_Q	–	0	2	Ω	$Z_Q = R + (j\omega C)^{-1}$

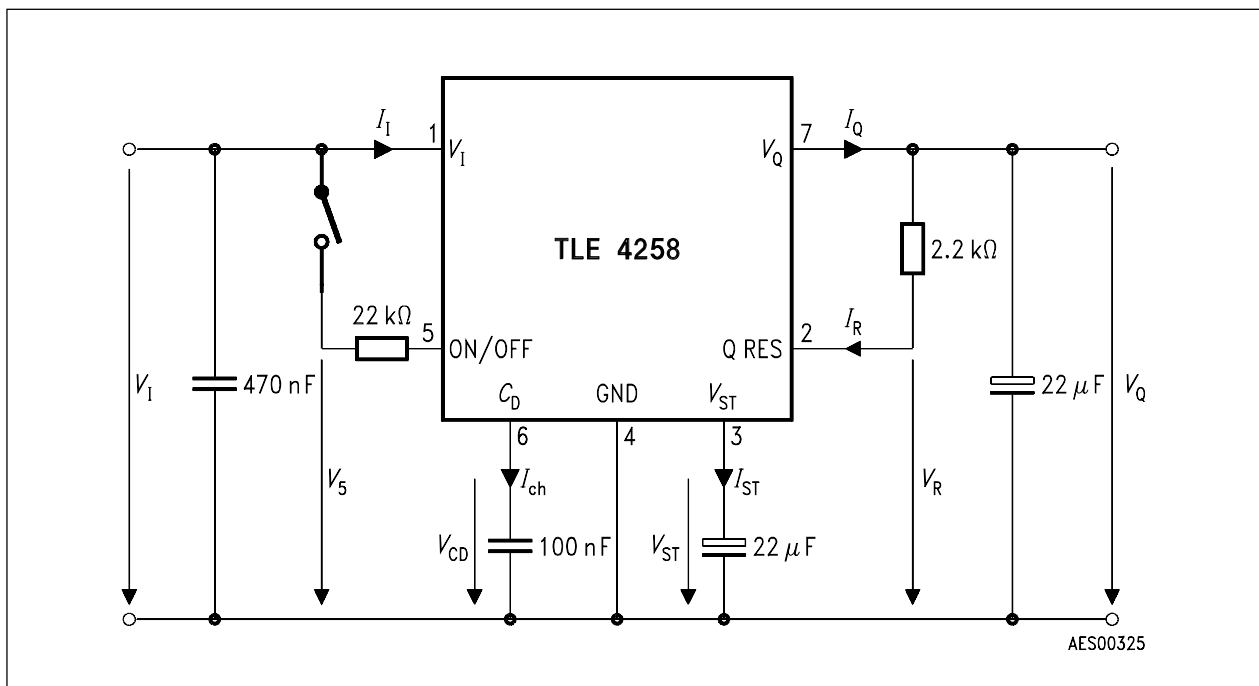

Application Circuit

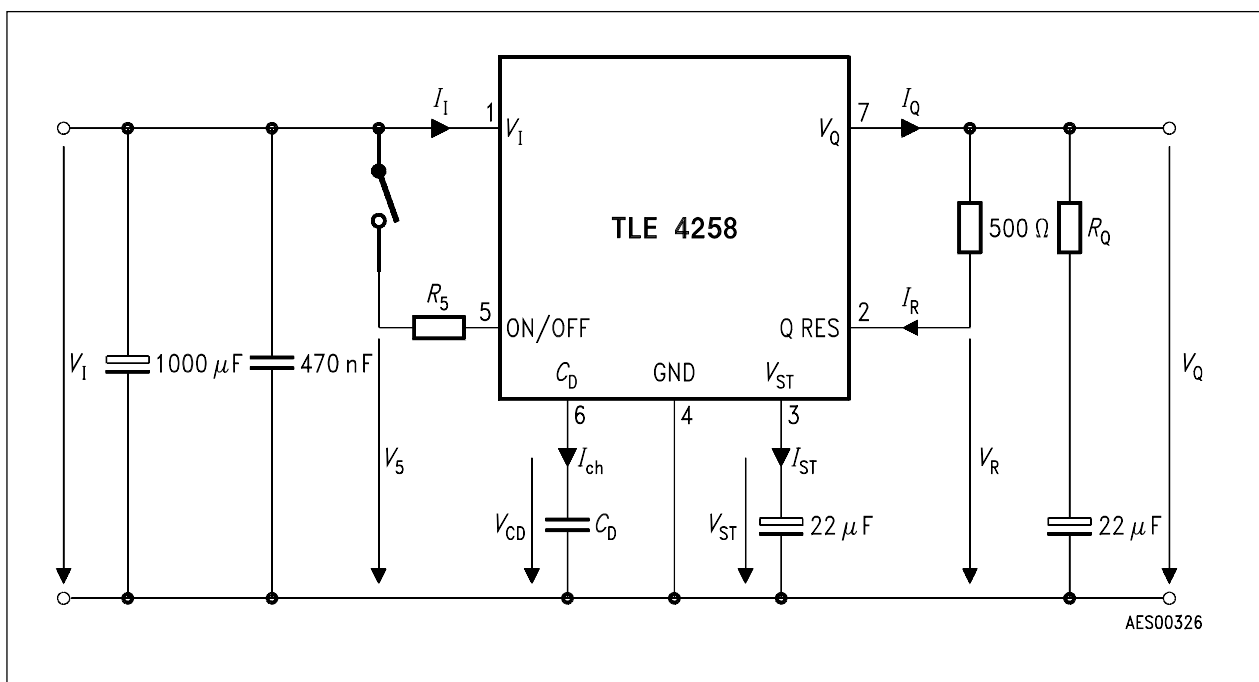

Test Circuit

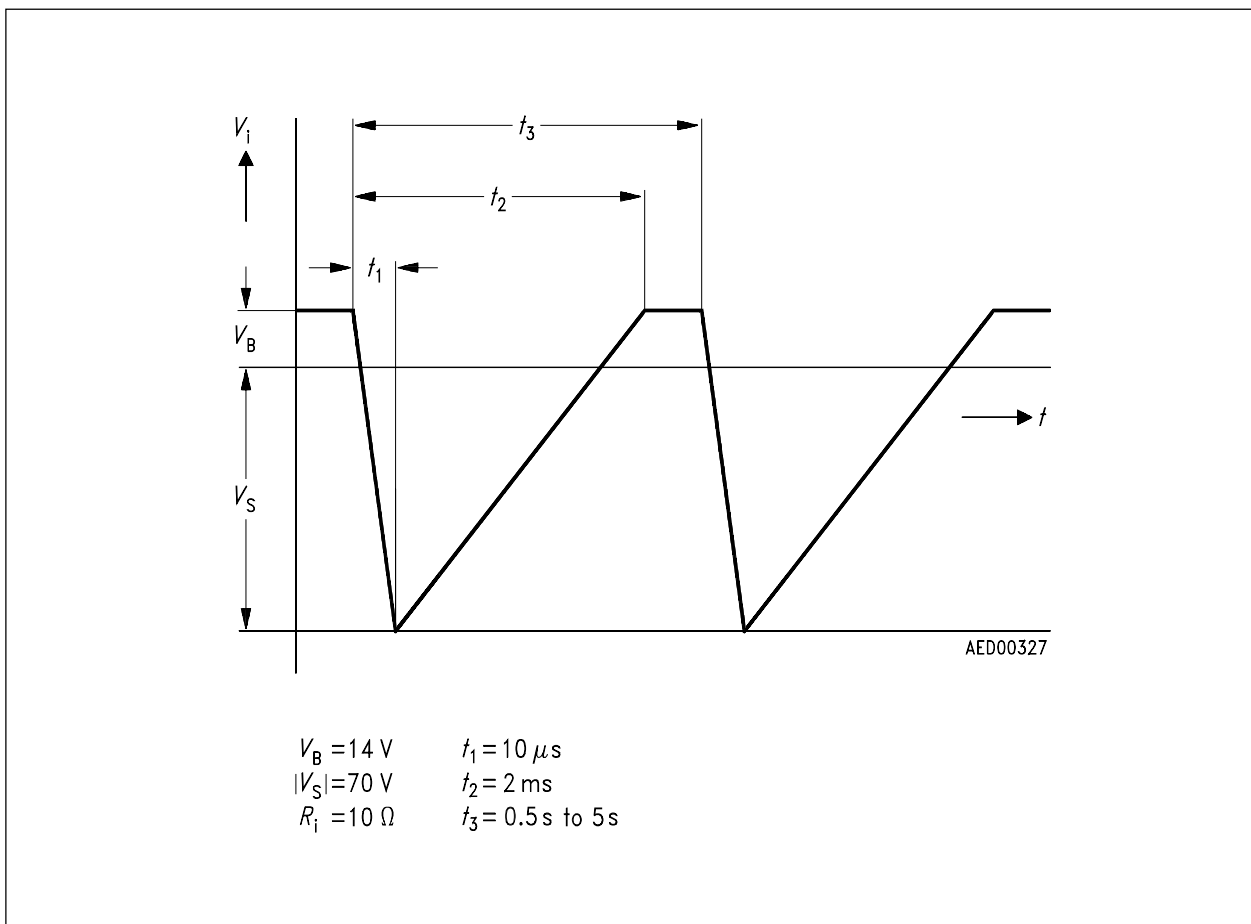

1. Test Pulse for Negative Interference Voltages V_i

$V_B = 14 \text{ V}$	$t_1 = 10 \mu\text{s}$
$V_S = 70 \text{ V}$	$t_2 = 2 \text{ ms}$
$R_i = 10 \Omega$	$t_3 = 0.5 \text{ s to } 5 \text{ s}$

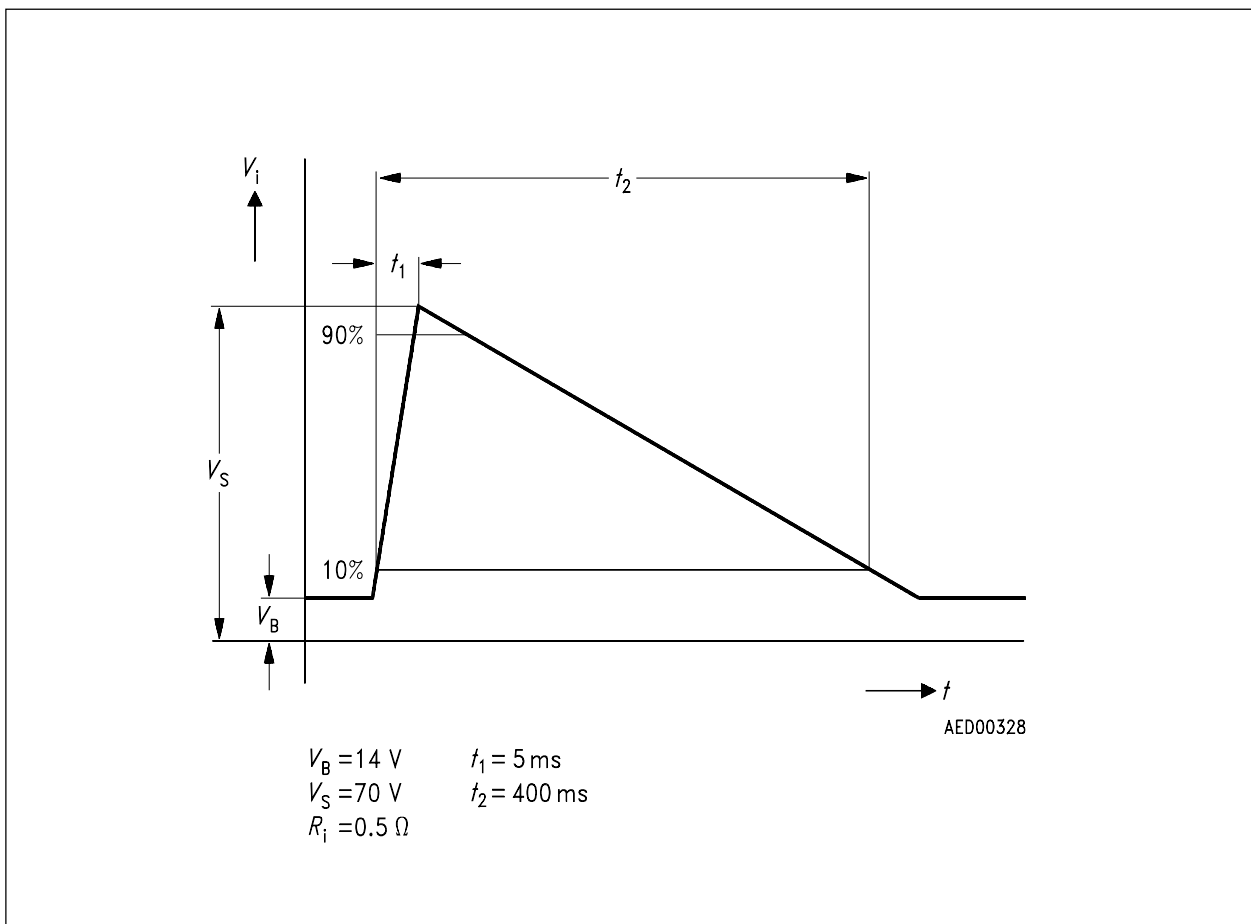

2. Pulse for Load Dump at V_{14}

$V_B = 14 \text{ V}$ $t_1 = 5 \text{ ms}$
 $V_S = 70 \text{ V}$ $t_2 = 400 \text{ ms}$
 $R_i = 0.5 \Omega$

Minimum Drop Voltage versus Output Current

$T_c = 25\text{ }^\circ\text{C}$; $V_i = 4.5\text{ V}$

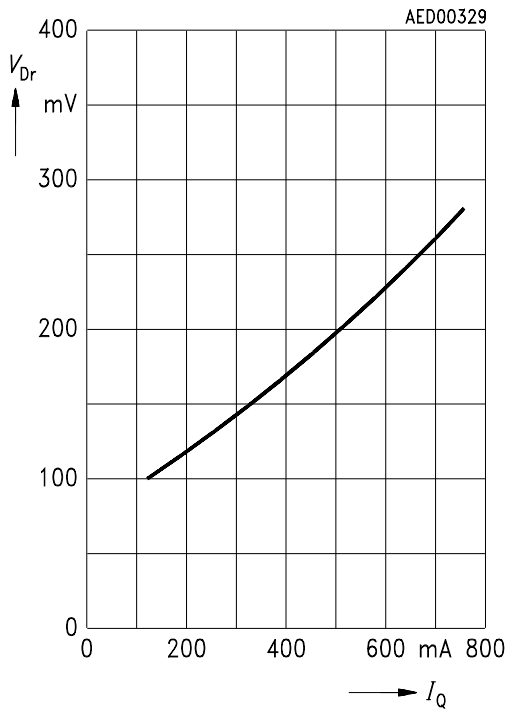

Current Consumption without Load versus Output Current

$T_c = 25\text{ }^\circ\text{C}$

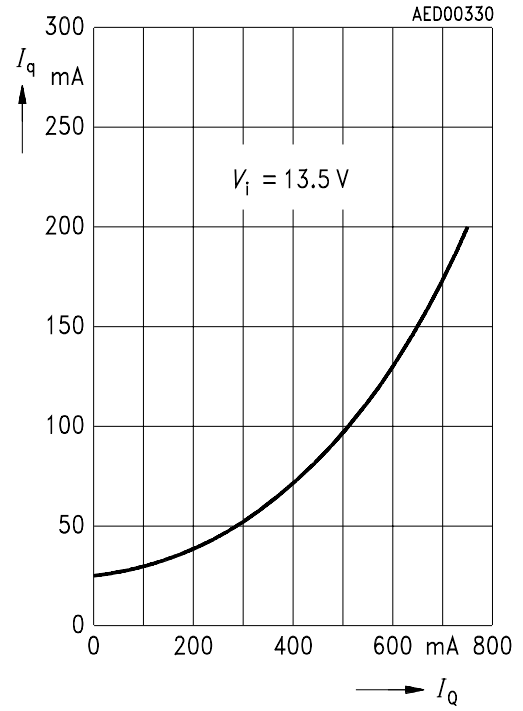

Current Consumption without Load versus Input Voltage

$T_c = 25\text{ }^\circ\text{C}$

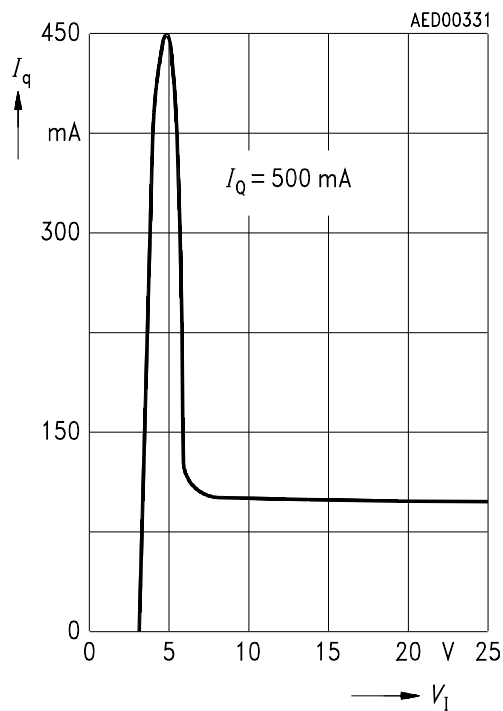

Output Voltage versus Input Voltage

$T_c = 25\text{ }^\circ\text{C}$

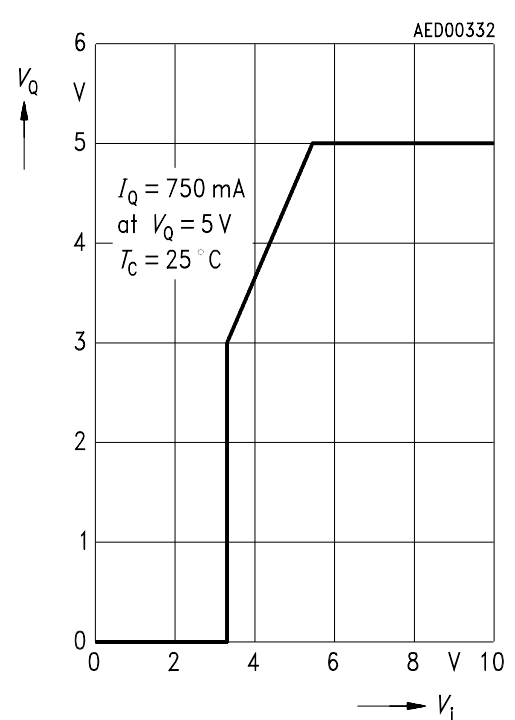

Output Voltage versus Temperature

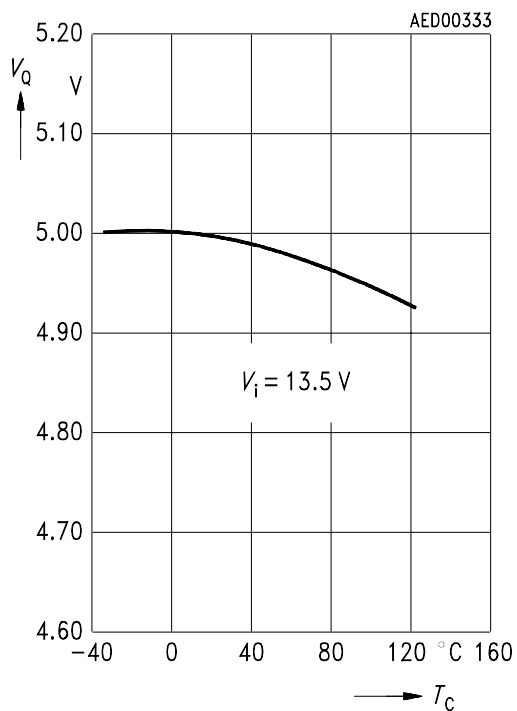

Short-Circuit Current versus Input Voltage

$T_c = 25 \text{ °C}$

