

## LM4890 Boomer® Audio Power Amplifier Series 1 Watt Audio Power Amplifier

Check for Samples: [LM4890](#)

### FEATURES

- Available in space-saving packages: micro SMD, MSOP, SOIC, and LLP
- Ultra low current shutdown mode
- BTL output can drive capacitive loads
- Improved pop & click circuitry eliminates noises during turn-on and turn-off transitions
- 2.2 - 5.5V operation
- No output coupling capacitors, snubber

networks or bootstrap capacitors required

- Thermal shutdown protection
- Unity-gain stable
- External gain configuration capability

### APPLICATIONS

- Mobile Phones
- PDAs
- Portable electronic devices

### DESCRIPTION

The LM4890 is an audio power amplifier primarily designed for demanding applications in mobile phones and other portable communication device applications. It is capable of delivering 1 watt of continuous average power to an 8Ω BTL load with less than 1% distortion (THD+N) from a 5V<sub>DC</sub> power supply.

Boomer audio power amplifiers were designed specifically to provide high quality output power with a minimal amount of external components. The LM4890 does not require output coupling capacitors or bootstrap capacitors, and therefore is ideally suited for mobile phone and other low voltage applications where minimal power consumption is a primary requirement.

The LM4890 features a low-power consumption shutdown mode, which is achieved by driving the shutdown pin with logic low. Additionally, the LM4890 features an internal thermal shutdown protection mechanism.

The LM4890 contains advanced pop & click circuitry which eliminates noises which would otherwise occur during turn-on and turn-off transitions.

The LM4890 is unity-gain stable and can be configured by external gain-setting resistors.

**Table 1. Key Specifications**

	VALUE	UNIT
■ PSRR at 217Hz, V <sub>DD</sub> = 5V (Fig. 1)	62	dB(typ.)
■ Power Output at 5.0V & 1% THD	1	W(typ.)
■ Power Output at 3.3V & 1% THD	400	mW(typ.)
■ Shutdown Current	0.1	μA(typ.)



Please be aware that an important notice concerning availability, standard warranty, and use in critical applications of Texas Instruments semiconductor products and disclaimers thereto appears at the end of this data sheet.

All trademarks are the property of their respective owners.

Connection Diagram

8 Bump micro SMD

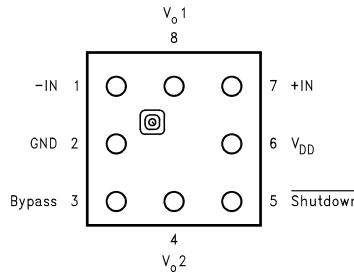

Figure 1. Top View  
 Order Number LM4890IBP, LM4890IBPX  
 See NS Package Number BPA08DDB

8 bump micro SMD Marking

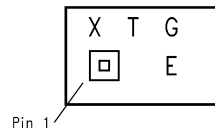

Figure 2. Top View  
 X - Date Code  
 T - Die Traceability  
 G - Boomer Family  
 E - LM4890IBP

9 Bump micro SMD

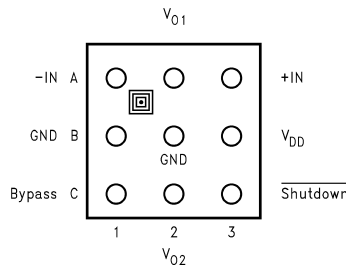

Figure 3. Top View  
 Order Number LM4890IBL, LM4890IBLX  
 See NS Package Number BLA09AAB

9 Bump micro SMD Marking

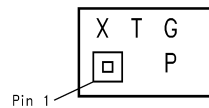
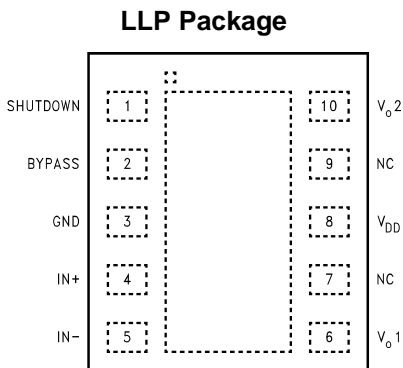
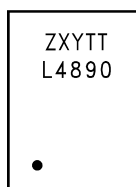

Figure 4. Top View  
 X - Date Code  
 T - Die Traceability  
 G - Boomer Family  
 P - LM4890IBL



**Figure 5. Top View**  
**Order Number LM4890LD**  
**See NS Package Number LDA10B**

**10 Pin LLP Marking**



**Figure 6. Top View**  
**Z - Assembly Plant Date Code (M for Malacca)**  
**XY - Digit Date Code**  
**TT - Die Traceability**  
**L4890 - LM4890LD**

**Mini Small Outline (MSOP) Package**

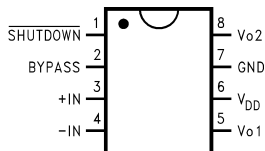

**Figure 7. Top View**  
**Order Number LM4890MM**  
**See NS Package Number MUA08A**

**MSOP Marking**

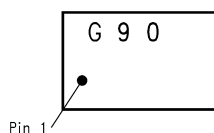

**Figure 8. Top View**  
**G - Boomer Family**  
**90 - LM4890MM**

**Small Outline (SO) Package**

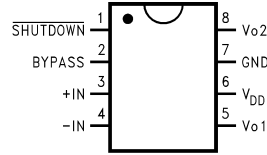

**Figure 9. Top View**  
**Order Number LM4890M**  
**See NS Package Number M08A**

**SO Marking**

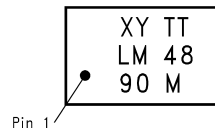

**Figure 10. Top View**  
**XY - Date Code**  
**TT - Die Traceability**  
**Bottom 2 lines - Part Number**

**9 Bump micro SMD**

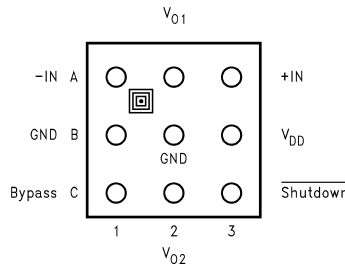

**Figure 11. Top View**  
**Order Number LM4890ITL, LM4890ITLX**  
**See NS Package Number TLA09AAA**

**9 Bump micro SMD Marking**

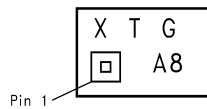

**Figure 12. Top View**  
**X - Date Code**  
**T - Die Traceability**  
**G - Boomer Family**  
**A8 - LM4890ITL**

Typical Application

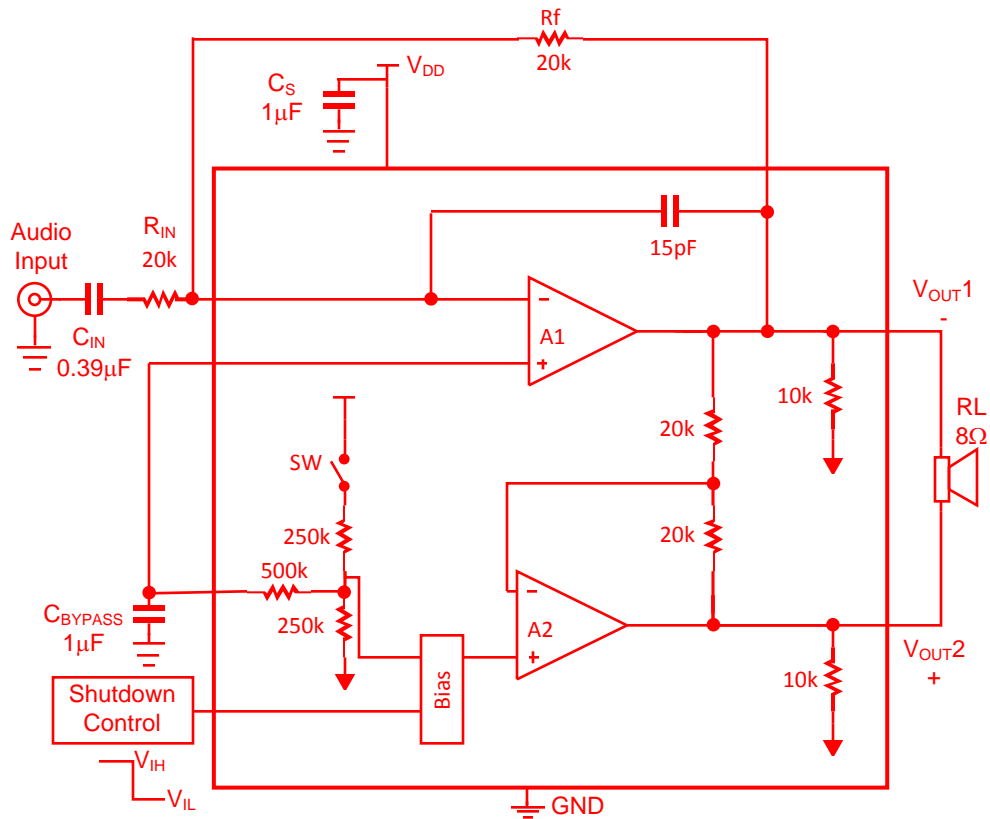

Figure 13. Typical Audio Amplifier Application Circuit



These devices have limited built-in ESD protection. The leads should be shorted together or the device placed in conductive foam during storage or handling to prevent electrostatic damage to the MOS gates.

### Absolute Maximum Ratings <sup>(1)</sup>

Supply Voltage <sup>(2)</sup>	6.0V
Storage Temperature	-65°C to +150°C
Input Voltage	-0.3V to V <sub>DD</sub> +0.3V
Power Dissipation <sup>(3)</sup>	Internally Limited
ESD Susceptibility <sup>(4)</sup>	2000V
Junction Temperature	150°C
Thermal Resistance	
$\theta_{JC}$ (SOP)	35°C/W
$\theta_{JA}$ (SOP)	150°C/W
$\theta_{JA}$ (8 Bump micro SMD, Note 12)	220°C/W
$\theta_{JA}$ (9 Bump micro SMD, Note 12)	180°C/W
$\theta_{JC}$ (MSOP)	56°C/W
$\theta_{JA}$ (MSOP)	190°C/W
$\theta_{JA}$ (LLP)	220°C/W
Soldering Information	
See AN-1112 "microSMD Wafers Level Chip Scale Package."	
See AN-1187 "Leadless Leadframe Package (LLP)."	

- (1) *Absolute Maximum Ratings* indicate limits beyond which damage to the device may occur. *Operating Ratings* indicate conditions for which the device is functional, but do not guarantee specific performance limits. *Electrical Characteristics* state DC and AC electrical specifications under particular test conditions which guarantee specific performance limits. This assumes that the device is within the *Operating Ratings*. Specifications are not guaranteed for parameters where no limit is given, however, the typical value is a good indication of device performance.
- (2) If the product is in shutdown mode and V<sub>DD</sub> exceeds 6V (to a max of 8V V<sub>DD</sub>), then most of the excess current will flow through the ESD protection circuits. If the source impedance limits the current to a max of 10 ma, then the part will be protected. If the part is enabled when V<sub>DD</sub> is greater than 5.5V and less than 6.5V, no damage will occur, although operational life will be reduced. Operation above 6.5V with no current limit will result in permanent damage.
- (3) The maximum power dissipation must be derated at elevated temperatures and is dictated by T<sub>JMAX</sub>,  $\theta_{JA}$ , and the ambient temperature T<sub>A</sub>. The maximum allowable power dissipation is P<sub>DMAX</sub> = (T<sub>JMAX</sub> - T<sub>A</sub>) /  $\theta_{JA}$  or the number given in Absolute Maximum Ratings, whichever is lower. For the LM4890, see power derating curves for additional information.
- (4) Human body model, 100 pF discharged through a 1.5 k $\Omega$  resistor.

### Operating Ratings

Temperature Range	
T <sub>MIN</sub> ≤ T <sub>A</sub> ≤ T <sub>MAX</sub>	-40°C ≤ T <sub>A</sub> ≤ 85°C
Supply Voltage	2.2V ≤ V <sub>DD</sub> ≤ 5.5V

## Electrical Characteristics $V_{DD} = 5V$

(1)(2)(3)

 The following specifications apply for the circuit shown in Figure 1 unless otherwise specified. Limits apply for  $T_A = 25^\circ\text{C}$ .

Symbol	Parameter	Conditions	LM4890		Units (Limits)
			Typical	Limit	
			(4)		
<sup>(5)(6)</sup> I <sub>DD</sub>	Quiescent Power Supply Current	V <sub>IN</sub> = 0V, I <sub>O</sub> = 0A, No Load	4	8	mA (max)
		V <sub>IN</sub> = 0V, I <sub>O</sub> = 0A, 8Ω Load	5	10	mA (max)
I <sub>SD</sub>	Shutdown Current	V <sub>SHUTDOWN</sub> = 0V	0.1	2.0	μA (max)
V <sub>SDIH</sub>	Shutdown Voltage Input High			1.2	V (min)
V <sub>SDIL</sub>	Shutdown Voltage Input Low			0.4	V (max)
V <sub>OS</sub>	Output Offset Voltage		7	50	mV (max)
R <sub>OUT-GND</sub>	Resistor Output to GND <sup>(7)</sup>		8.5	9.7	kΩ (max)
				7.0	kΩ (min)
P <sub>O</sub>	Output Power (8Ω)	THD = 2% (max); f = 1 kHz	1.0	0.8	W
T <sub>WU</sub>	Wake-up time		170	220	ms (max)
T <sub>SD</sub>	Thermal Shutdown Temperature		170	150	°C (min)
				190	°C (max)
THD+N	Total Harmonic Distortion + Noise	P <sub>O</sub> = 0.4 Wrms; f = 1kHz	0.1		%
PSRR	Power Supply Rejection Ratio <sup>(8)</sup>	V <sub>ripple</sub> = 200mV sine p-p Input Terminated with 10 ohms to ground	62 (f = 217Hz) 66 (f = 1kHz)	55	dB (min)
T <sub>SdT</sub>	Shut Down Time	8 Ω load	1.0		ms (max)

- (1) All voltages are measured with respect to the ground pin, unless otherwise specified.
- (2) *Absolute Maximum Ratings* indicate limits beyond which damage to the device may occur. *Operating Ratings* indicate conditions for which the device is functional, but do not guarantee specific performance limits. *Electrical Characteristics* state DC and AC electrical specifications under particular test conditions which guarantee specific performance limits. This assumes that the device is within the Operating Ratings. Specifications are not guaranteed for parameters where no limit is given, however, the typical value is a good indication of device performance.
- (3) For micro SMD only, shutdown current is measured in a Normal Room Environment. Exposure to direct sunlight will increase I<sub>SD</sub> by a maximum of 2μA.
- (4) Typicals are measured at 25°C and represent the parametric norm.
- (5) Limits are guaranteed to National's AOQL (Average Outgoing Quality Level).
- (6) Datasheet min/max specification limits are guaranteed by design, test, or statistical analysis.
- (7) R<sub>OUT</sub> is measured from each of the output pins to ground. This value represents the parallel combination of the 10k ohm output resistors and the two 20k ohm resistors.
- (8) PSRR is a function of system gain. Specifications apply to the circuit in Figure 1 where A<sub>v</sub> = 2. Higher system gains will reduce PSRR value by the amount of gain increase. A system gain of 10 represents a gain increase of 14dB. PSRR will be reduced by 14dB and applies to all operating voltages.

## Electrical Characteristics $V_{DD} = 3V$

(1)(2)(3)

The following specifications apply for the circuit shown in Figure 1 unless otherwise specified. Limits apply for  $T_A = 25^\circ\text{C}$ .

Symbol	Parameter	Conditions	LM4890		Units (Limits)
			Typical	Limit	
			(4)		
<sup>(5)(6)</sup> $I_{DD}$	Quiescent Power Supply Current	$V_{IN} = 0V, I_O = 0A$ , No Load	3.5	7	mA (max)
		$V_{IN} = 0V, I_O = 0A$ , $8\Omega$ Load	4.5	9	mA (max)
$I_{SD}$	Shutdown Current	$V_{SHUTDOWN} = 0V$	0.1	2.0	$\mu\text{A}$ (max)
$V_{SDIH}$	Shutdown Voltage Input High			1.2	V(min)
$V_{SDIL}$	Shutdown Voltage Input Low			0.4	V(max)
$V_{OS}$	Output Offset Voltage		7	50	mV (max)
$R_{OUT-GND}$	Resistor Output to Gnd <sup>(7)</sup>		8.5	9.7	k $\Omega$ (max)
				7.0	k $\Omega$ (min)
$T_{WU}$	Wake-up time		120	180	ms (max)
$P_o$	Output Power (8 $\Omega$ )	THD = 1% (max); f = 1kHz	0.31	0.28	W
$T_{SD}$	Thermal Shutdown Temperature		170	150	$^\circ\text{C}$ (min)
				190	$^\circ\text{C}$ (max)
THD+N	Total Harmonic Distortion + Noise	$P_o = 0.15W_{rms}$ ; f = 1kHz	0.1		%
PSRR	Power Supply Rejection Ratio <sup>(8)</sup>	$V_{ripple} = 200\text{mV}$ sine p-p Input terminated with 10 ohms to ground	56 (f = 217Hz) 62 (f = 1kHz)	45	dB(min)

- (1) All voltages are measured with respect to the ground pin, unless otherwise specified.
- (2) *Absolute Maximum Ratings* indicate limits beyond which damage to the device may occur. *Operating Ratings* indicate conditions for which the device is functional, but do not guarantee specific performance limits. *Electrical Characteristics* state DC and AC electrical specifications under particular test conditions which guarantee specific performance limits. This assumes that the device is within the Operating Ratings. Specifications are not guaranteed for parameters where no limit is given, however, the typical value is a good indication of device performance.
- (3) For micro SMD only, shutdown current is measured in a Normal Room Environment. Exposure to direct sunlight will increase  $I_{SD}$  by a maximum of  $2\mu\text{A}$ .
- (4) Typicals are measured at  $25^\circ\text{C}$  and represent the parametric norm.
- (5) Limits are guaranteed to National's AOQL (Average Outgoing Quality Level).
- (6) Datasheet min/max specification limits are guaranteed by design, test, or statistical analysis.
- (7) ROUT is measured from each of the output pins to ground. This value represents the parallel combination of the 10k ohm output resistors and the two 20k ohm resistors.
- (8) PSRR is a function of system gain. Specifications apply to the circuit in Figure 1 where  $A_V = 2$ . Higher system gains will reduce PSRR value by the amount of gain increase. A system gain of 10 represents a gain increase of 14dB. PSRR will be reduced by 14dB and applies to all operating voltages.



## Electrical Characteristics $V_{DD} = 2.6V$

(1)(2)(3)

 The following specifications apply for for the circuit shown in Figure 1 unless otherwise specified. Limits apply for  $T_A = 25^\circ C$ .

Symbol	Parameter	Conditions	LM4890		Units (Limits)
			Typical	Limit	
			(4)		
<sup>(5)(6)</sup> $I_{DD}$	Quiescent Power Supply Current	$V_{IN} = 0V, I_o = 0A$ , No Load	2.6		mA (max)
$I_{SD}$	Shutdown Current	$V_{SHUTDOWN} = 0V$	0.1		$\mu A$ (max)
$P_o$	Output Power (8 $\Omega$ ) Output Power (4 $\Omega$ )	THD = 1% (max); f = 1 kHz THD = 1% (max); f = 1 kHz	0.2 0.22		W W
THD+N	Total Harmonic Distortion + Noise	$P_o = 0.1W_{rms}$ ; f = 1kHz	0.08		%
PSRR	Power Supply Rejection Ratio <sup>(7)</sup>	$V_{ripple} = 200mV$ sine p-p Input Terminated with 10 ohms to ground	44 (f = 217Hz) 44 (f = 1kHz)		dB

- (1) All voltages are measured with respect to the ground pin, unless otherwise specified.
- (2) *Absolute Maximum Ratings* indicate limits beyond which damage to the device may occur. *Operating Ratings* indicate conditions for which the device is functional, but do not guarantee specific performance limits. *Electrical Characteristics* state DC and AC electrical specifications under particular test conditions which guarantee specific performance limits. This assumes that the device is within the Operating Ratings. Specifications are not guaranteed for parameters where no limit is given, however, the typical value is a good indication of device performance.
- (3) For micro SMD only, shutdown current is measured in a Normal Room Environment. Exposure to direct sunlight will increase  $I_{SD}$  by a maximum of 2 $\mu A$ .
- (4) Typical values are measured at 25°C and represent the parametric norm.
- (5) Limits are guaranteed to National's AOQL (Average Outgoing Quality Level).
- (6) Datasheet min/max specification limits are guaranteed by design, test, or statistical analysis.
- (7) PSRR is a function of system gain. Specifications apply to the circuit in Figure 1 where  $A_v = 2$ . Higher system gains will reduce PSRR value by the amount of gain increase. A system gain of 10 represents a gain increase of 14dB. PSRR will be reduced by 14dB and applies to all operating voltages.

## External Components Description

(Figure 13)

Components		Functional Description
1.	$R_{IN}$	Inverting input resistance which sets the closed-loop gain in conjunction with $R_f$ . This resistor also forms a high pass filter with $C_{IN}$ at $f_c = 1/(2\pi R_{IN}C_{IN})$ .
2.	$C_{IN}$	Input coupling capacitor which blocks the DC voltage at the amplifier's input terminals. Also creates a highpass filter with $R_{IN}$ at $f_c = 1/(2\pi R_{IN}C_{IN})$ . Refer to the section, <b>Proper Selection of External Components</b> , for an explanation of how to determine the value of $C_{IN}$ .
3.	$R_f$	Feedback resistance which sets the closed-loop gain in conjunction with $R_{IN}$ .
4.	$C_S$	Supply bypass capacitor which provides power supply filtering. Refer to the section, <b>Power Supply Bypassing</b> , for information concerning proper placement and selection of the supply bypass capacitor, $C_{BYPASS}$ .
5.	$C_{BYPASS}$ S	Bypass pin capacitor which provides half-supply filtering. Refer to the section, <b>Proper Selection of External Components</b> , for information concerning proper placement and selection of $C_{BYPASS}$ .

### Typical Performance Characteristics

**THD+N vs Frequency**  
 at  $V_{DD} = 5V$ ,  $8\Omega R_L$ , and  $PWR = 250mW$ ,  $A_V = 2$

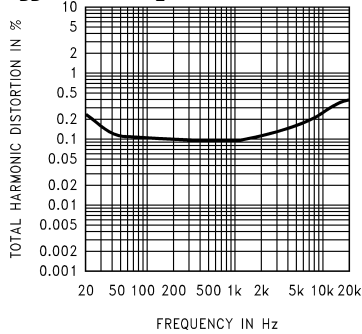

**THD+N vs Frequency**  
 at  $V_{DD} = 3.3V$ ,  $8\Omega R_L$ , and  $PWR = 150mW$ ,  $A_V = 2$

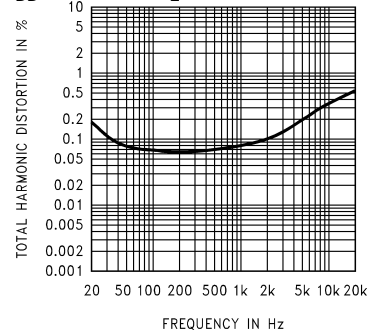

**THD+N vs Frequency**  
 at  $V_{DD} = 3V$ ,  $R_L = 8\Omega$ ,  $PWR = 250mW$ ,  $A_V = 2$

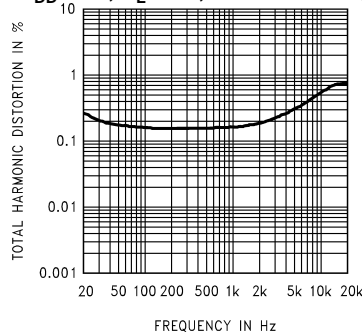

**THD+N vs Frequency**  
 @  $V_{DD} = 2.6V$ ,  $R_L = 8\Omega$ ,  $PWR = 100mW$ ,  $A_V = 2$

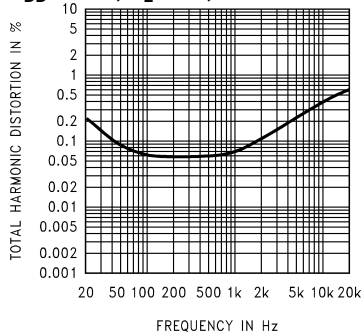

**THD+N vs Frequency**  
 @  $V_{DD} = 2.6V$ ,  $R_L = 4\Omega$ ,  $PWR = 100mW$ ,  $A_V = 2$

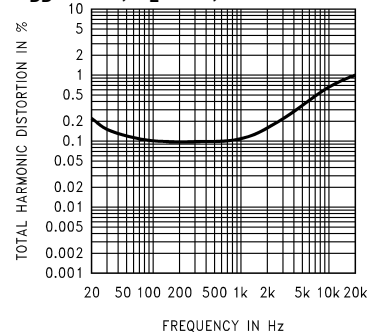

Typical Performance Characteristics (continued)

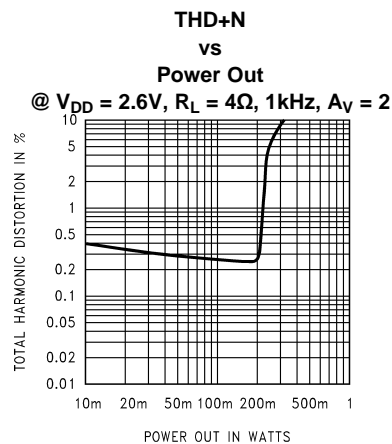
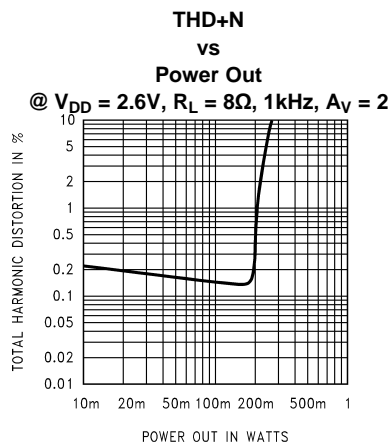
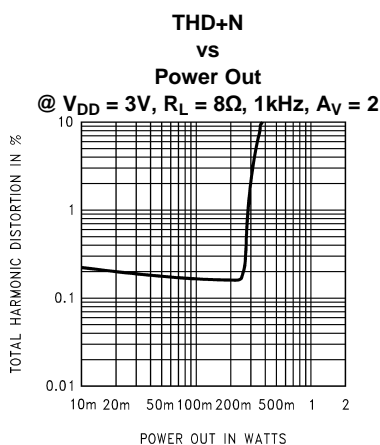
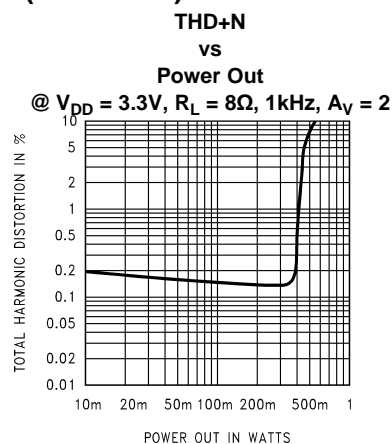
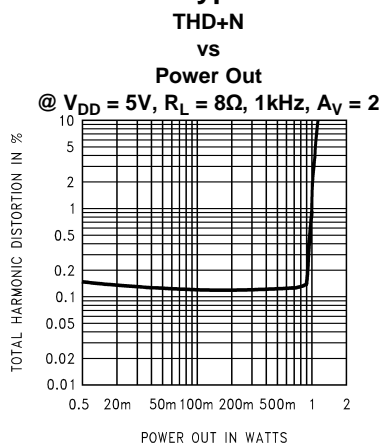

**Typical Performance Characteristics (continued)**

**Power Supply Rejection Ratio (PSRR) @  $A_V = 2$**

$V_{DD} = 5V$ ,  $V_{ripple} = 200mvp-p$   
 $R_L = 8\Omega$ ,  $R_{IN} = 10\Omega$

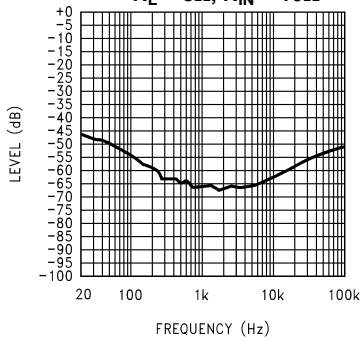

**Power Supply Rejection Ratio (PSRR) @  $A_V = 2$**

$V_{DD} = 5V$ ,  $V_{ripple} = 200mvp-p$   
 $R_L = 8\Omega$ ,  $R_{IN} = \text{Float}$

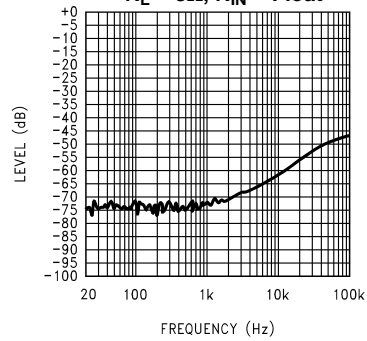

**Power Supply Rejection Ratio (PSRR) @  $A_V = 4$**

$V_{DD} = 5V$ ,  $V_{ripple} = 200mvp-p$   
 $R_L = 8\Omega$ ,  $R_{IN} = 10\Omega$

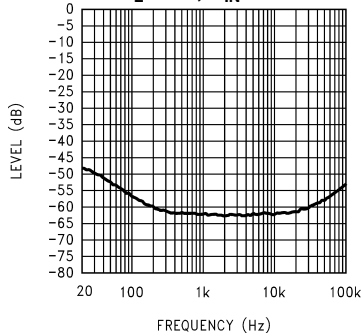

**Power Supply Rejection Ratio (PSRR) @  $A_V = 4$**

$V_{DD} = 5V$ ,  $V_{ripple} = 200mvp-p$   
 $R_L = 8\Omega$ ,  $R_{IN} = \text{Float}$

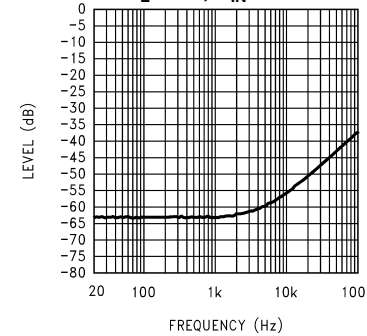

**Power Supply Rejection Ratio (PSRR) @  $A_V = 2$**

$V_{DD} = 3V$ ,  $V_{ripple} = 200mvp-p$   
 $R_L = 8\Omega$ ,  $R_{IN} = 10\Omega$

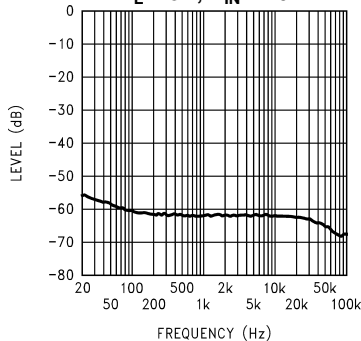

**Power Supply Rejection Ratio (PSRR) @  $A_V = 2$**

$V_{DD} = 3V$ ,  $V_{ripple} = 200mvp-p$   
 $R_L = 8\Omega$ ,  $R_{IN} = \text{Float}$

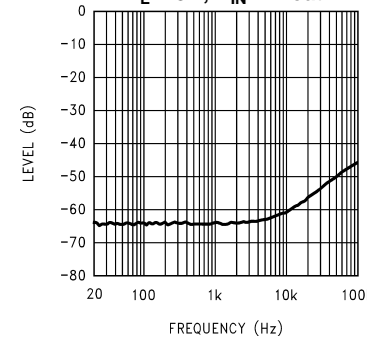

**Power Supply Rejection Ratio (PSRR) @  $A_V = 4$**

$V_{DD} = 3V$ ,  $V_{ripple} = 200mvp-p$   
 $R_L = 8\Omega$ ,  $R_{IN} = 10\Omega$

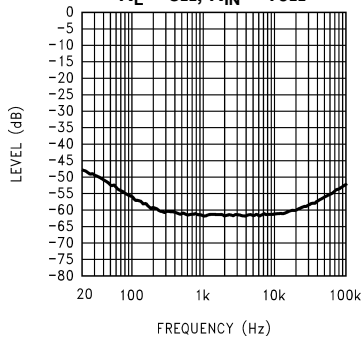

**Power Supply Rejection Ratio (PSRR) @  $A_V = 4$**

$V_{DD} = 3V$ ,  $V_{ripple} = 200mvp-p$   
 $R_L = 8\Omega$ ,  $R_{IN} = \text{Float}$

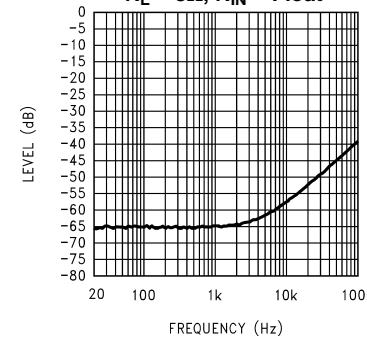

**Typical Performance Characteristics (continued)**

**Power Supply Rejection Ratio (PSRR) @  $A_V = 2$**

$V_{DD} = 3.3V$ ,  $V_{ripple} = 200mvp-p$ ,  
 $R_L = 8\Omega$ ,  $R_{IN} = 10\Omega$

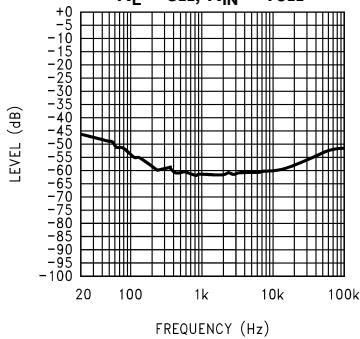

**Power Supply Rejection Ratio (PSRR) @  $A_V = 2$**

$V_{DD} = 2.6V$ ,  $V_{ripple} = 200mvp-p$ ,  
 $R_L = 8\Omega$ ,  $R_{IN} = 10\Omega$

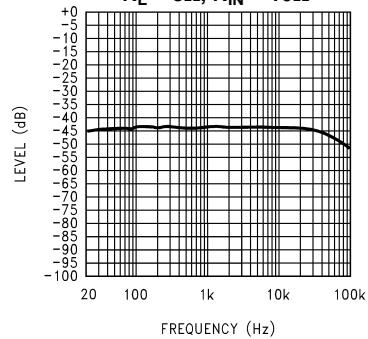

**PSRR  
vs  
DC Output Voltage  
 $V_{DD} = 5V$ ,  $A_V = 2$**

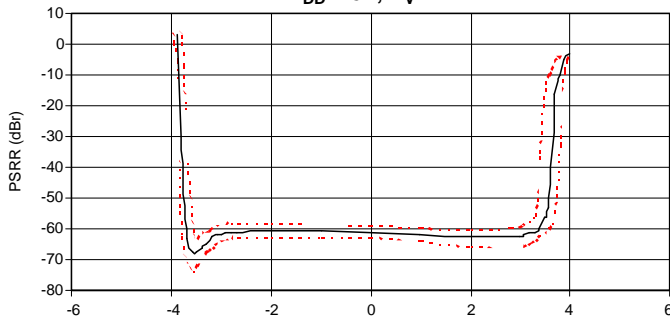

**PSRR  
vs  
DC Output Voltage  
 $V_{DD} = 5V$ ,  $A_V = 4$**

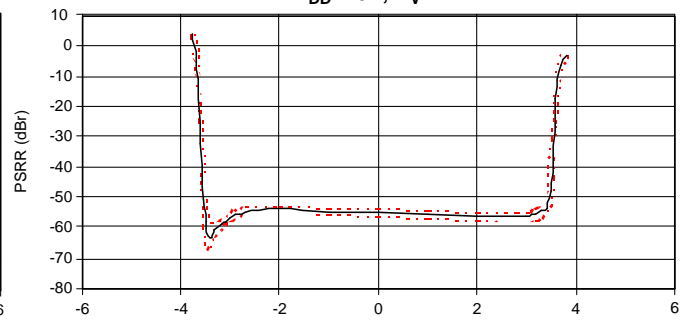

**PSRR  
vs  
DC Output Voltage  
 $V_{DD} = 5V$ ,  $A_V = 10$**

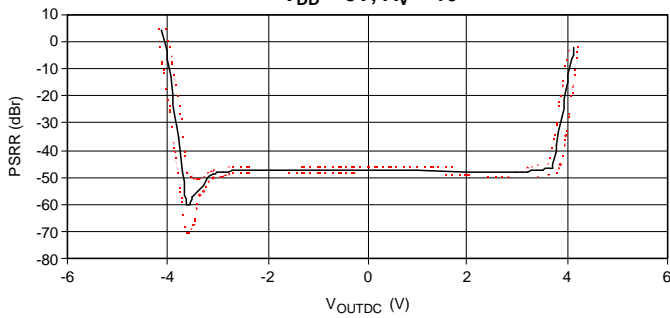

**PSRR  
vs  
DC Output Voltage  
 $V_{DD} = 3V$ ,  $A_V = 2$**

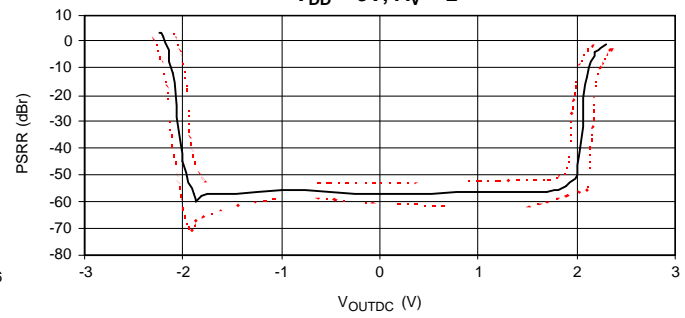

Typical Performance Characteristics (continued)

PSRR  
vs  
DC Output Voltage  
 $V_{DD} = 3V, A_V = 4$

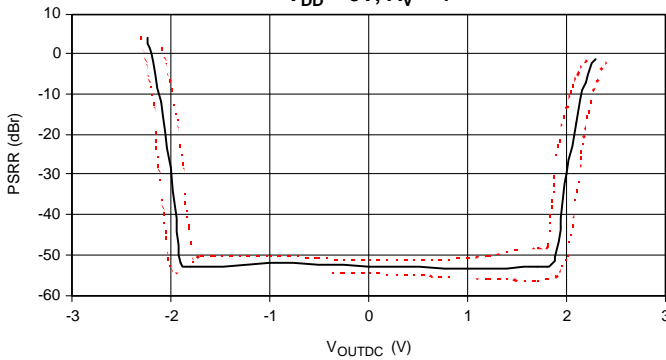

PSRR  
vs  
DC Output Voltage  
 $V_{DD} = 3V, A_V = 10$

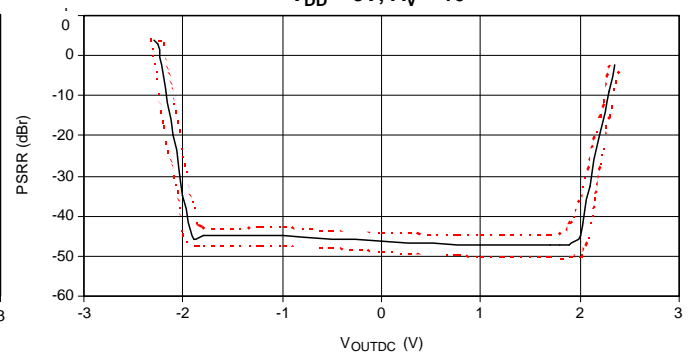

PSRR Distribution  $V_{DD} = 5V$   
217Hz, 200mvp-p,  
-30, +25, and +80°C

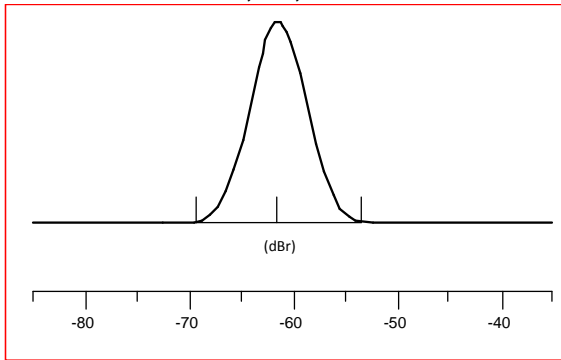

PSRR Distribution  $V_{DD} = 3V$   
217Hz, 200mvp-p,  
-30, +25, and +80°C

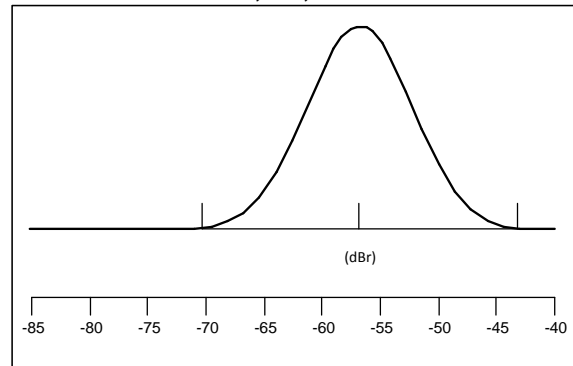

Power Supply Rejection Ratio  
vs  
Bypass Capacitor Size

$V_{DD} = 5V$ , Input Grounded =  $10\Omega$ , Output Load =  $8\Omega$

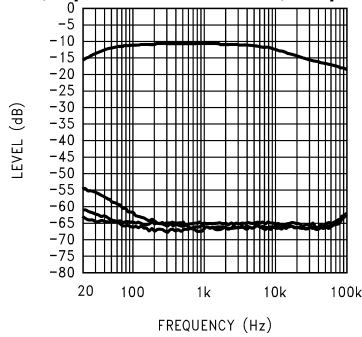

Figure 14. Top Trace = No Cap, Next Trace Down =  $1\mu f$   
Next Trace Down =  $2\mu f$ , Bottom Trace =  $4.7\mu f$

Power Supply Rejection Ratio  
vs  
Bypass Capacitor Size

$V_{DD} = 3V$ , Input Grounded =  $10\Omega$ , Output Load =  $8\Omega$

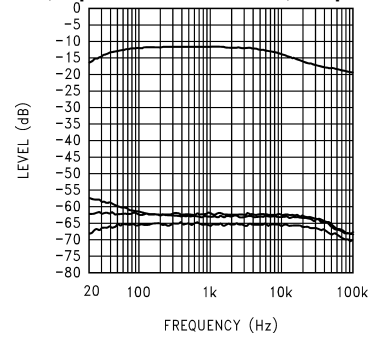

Figure 15. Top Trace = No Cap, Next Trace Down =  $1\mu f$   
Next Trace Down =  $2\mu f$ , Bottom Trace =  $4.7\mu f$

Typical Performance Characteristics (continued)

LM4890  
vs  
LM4877 Power Supply Rejection Ratio  
 $V_{DD} = 5V$ , Input Grounded =  $10\Omega$   
Output Load =  $8\Omega$ , 200mV Ripple

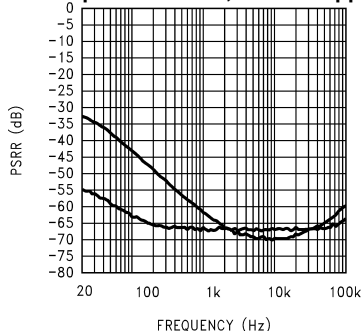

Figure 16. LM4890 = Bottom Trace  
LM4877 = Top Trace

LM4890  
vs  
LM4877 Power Supply Rejection Ratio  
 $V_{DD} = 3V$ , Input Grounded =  $10\Omega$   
Output Load =  $8\Omega$ , 200mV Ripple

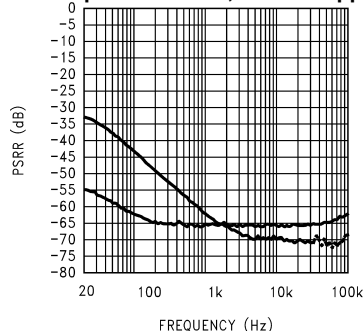

Figure 17. LM4890 = Bottom Trace  
LM4877 = Top Trace

Power Derating Curves ( $P_{DMAX} = 670mW$ )

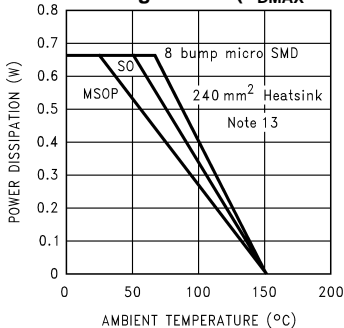

Figure 18. Ambient Temperature in Degrees C  
Note: ( $P_{DMAX} = 670mW$  for 5V,  $8\Omega$ )

Power Derating - 8 bump  $\mu$ SMD ( $P_{DMAX} = 670mW$ )

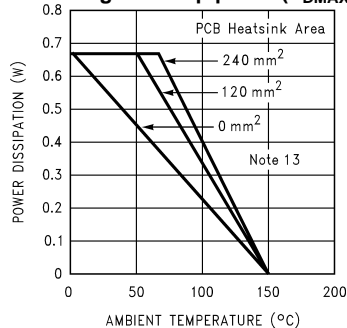

Figure 19. Ambient Temperature in Degrees C  
Note: ( $P_{DMAX} = 670mW$  for 5V,  $8\Omega$ )

Power Derating - 9 bump  $\mu$ SMD ( $P_{DMAX} = 670mW$ )

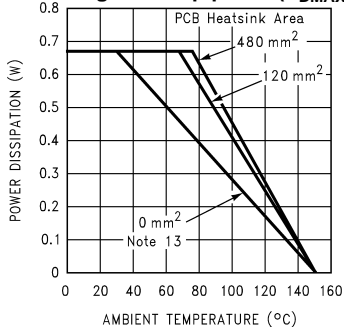

Figure 20. Ambient Temperature in Degrees C  
Note: ( $P_{DMAX} = 670mW$  for 5V,  $8\Omega$ )

Power Derating - 10 Pin LD Pkg ( $P_{DMAX} = 670mW$ )

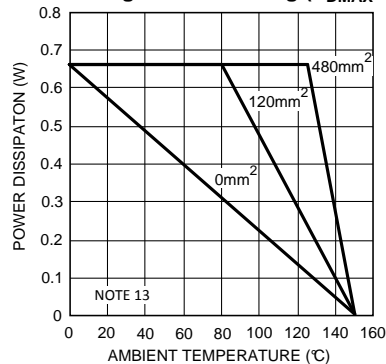
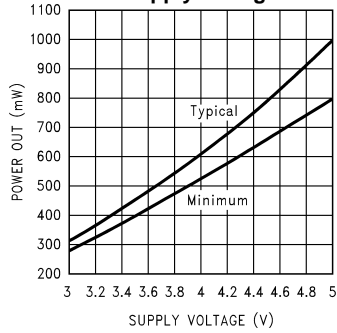

Figure 21. Ambient Temperature in Degrees C  
Note: ( $P_{DMAX} = 670mW$  for 5V,  $8\Omega$ )

**Typical Performance Characteristics (continued)**

**Power Output vs Supply Voltage**



**Power Output vs Temperature**

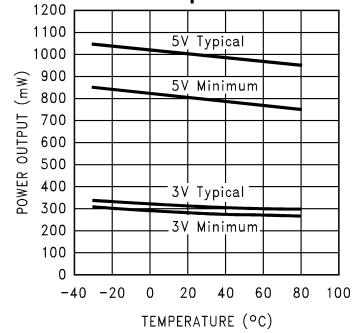

**Power Dissipation vs Output Power**

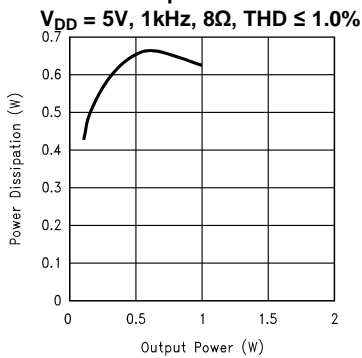

**Power Dissipation vs Output Power**

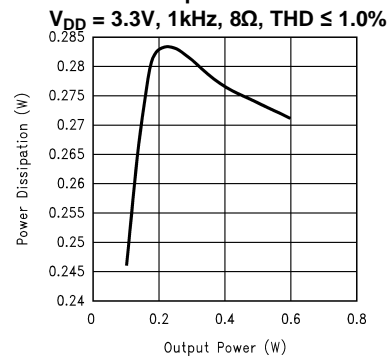

**Power Dissipation vs Output Power**

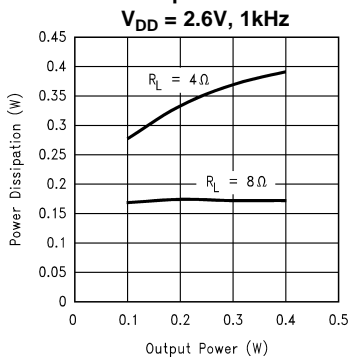

**Output Power vs Load Resistance**

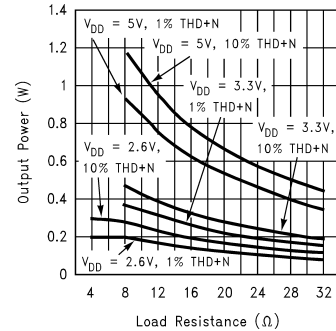

**Supply Current vs Ambient Temperature**

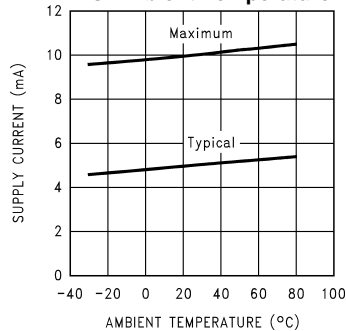

**Clipping (Dropout) Voltage vs Supply Voltage**

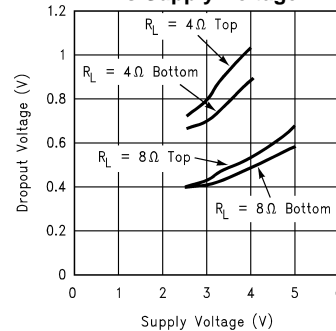



Typical Performance Characteristics (continued)

Max Die Temp  
at P<sub>DMAX</sub> (9 bump microSMD)

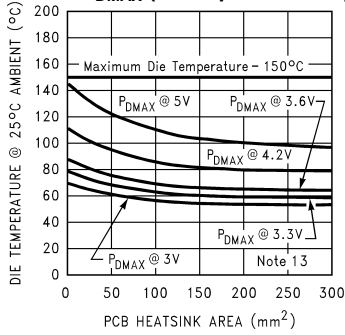

Max Die Temp  
at P<sub>DMAX</sub> (8 bump microSMD)

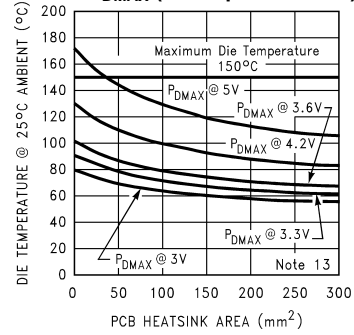

Output Offset Voltage

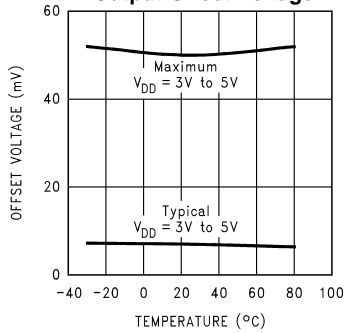

Supply Current  
vs Shutdown Voltage

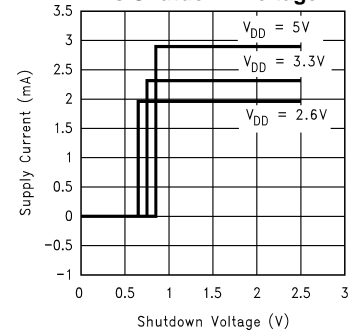

Shutdown Hysteresis Voltage  
V<sub>DD</sub> = 5V

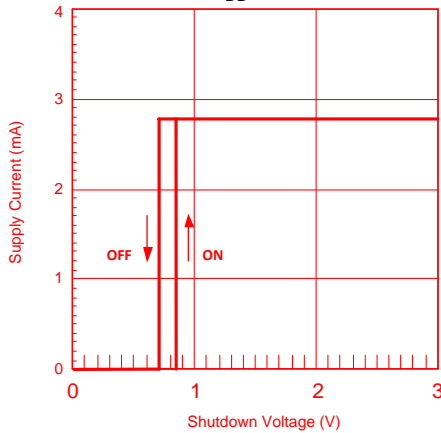

Shutdown Hysteresis Voltage  
V<sub>DD</sub> = 3V

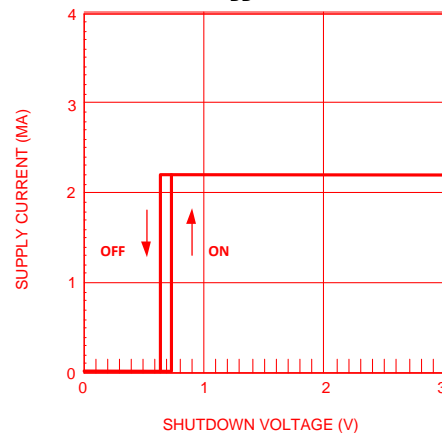

Open Loop Frequency Response  
V<sub>DD</sub> = 5V, No Load

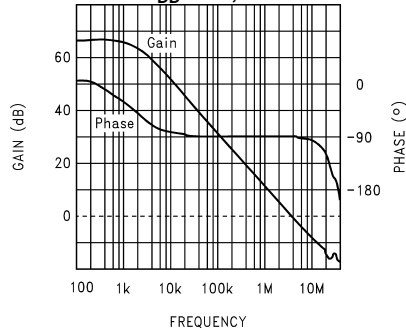

Open Loop Frequency Response  
V<sub>DD</sub> = 3V, No Load

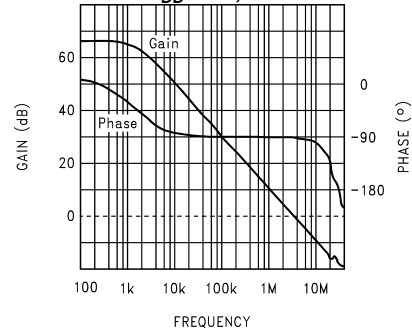

Typical Performance Characteristics (continued)

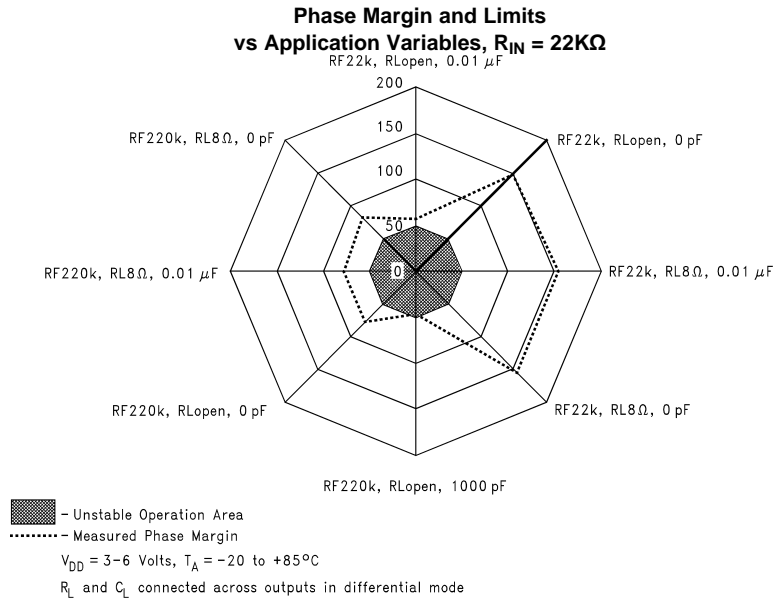
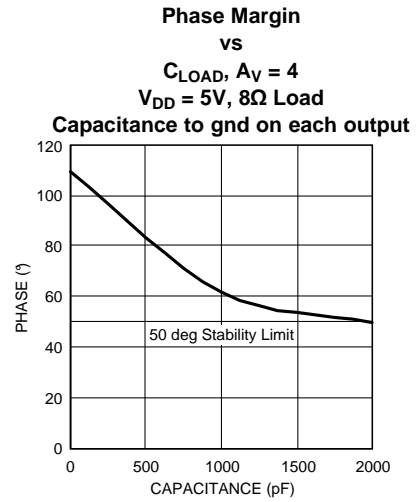
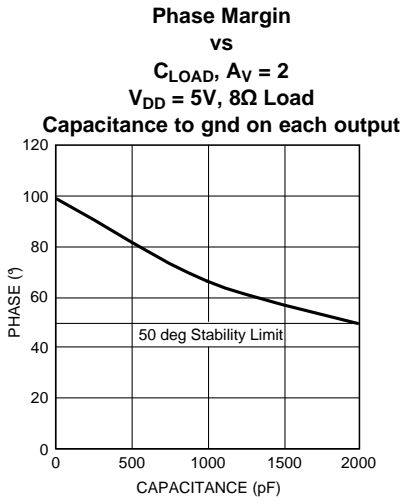
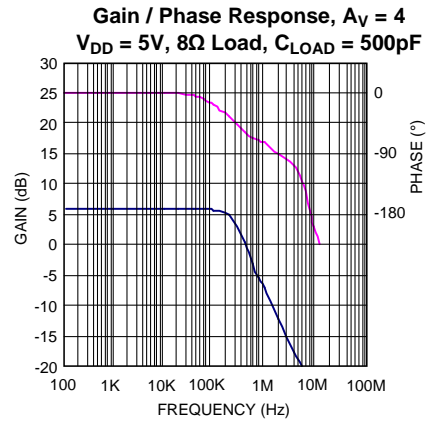
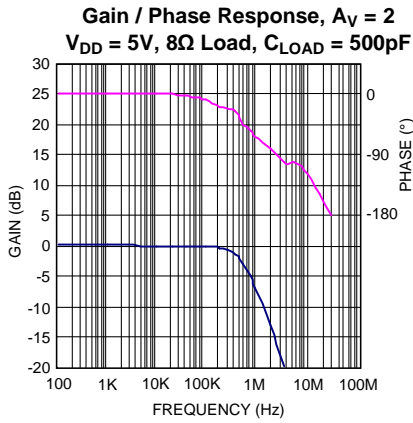

Typical Performance Characteristics (continued)

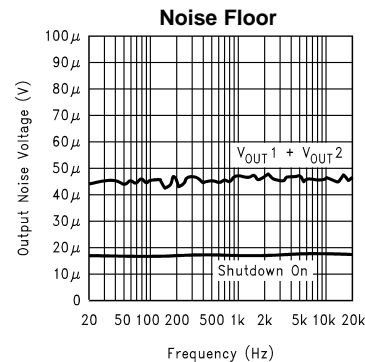
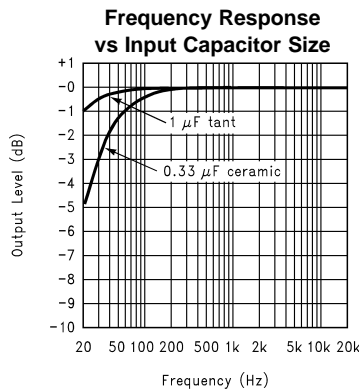
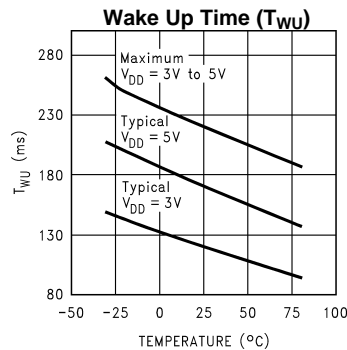

Application Information

BRIDGED CONFIGURATION EXPLANATION

As shown in Figure 13, the LM4890 has two operational amplifiers internally, allowing for a few different amplifier configurations. The first amplifier's gain is externally configurable, while the second amplifier is internally fixed in a unity-gain, inverting configuration. The closed-loop gain of the first amplifier is set by selecting the ratio of  $R_f$  to  $R_{IN}$  while the second amplifier's gain is fixed by the two internal  $20k\Omega$  resistors. Figure 13 shows that the output of amplifier one serves as the input to amplifier two which results in both amplifiers producing signals identical in magnitude, but out of phase by  $180^\circ$ . Consequently, the differential gain for the IC is

$$A_{VD} = 2 * (R_f / R_{IN}) \tag{1}$$

By driving the load differentially through outputs  $Vo1$  and  $Vo2$ , an amplifier configuration commonly referred to as "bridged mode" is established. Bridged mode operation is different from the classical single-ended amplifier configuration where one side of the load is connected to ground.

A bridge amplifier design has a few distinct advantages over the single-ended configuration, as it provides differential drive to the load, thus doubling output swing for a specified supply voltage. Four times the output power is possible as compared to a single-ended amplifier under the same conditions. This increase in attainable output power assumes that the amplifier is not current limited or clipped. In order to choose an amplifier's closed-loop gain without causing excessive clipping, please refer to the **Audio Power Amplifier Design** section.

A bridge configuration, such as the one used in the LM4890, also creates a second advantage over single-ended amplifiers. Since the differential outputs,  $Vo1$  and  $Vo2$ , are biased at half-supply, no net DC voltage exists across the load. This eliminates the need for an output coupling capacitor which is required in a single supply, single-ended amplifier configuration. Without an output coupling capacitor, the half-supply bias across the load would result in both increased internal IC power dissipation and also possible loudspeaker damage.

## EXPOSED-DAP PACKAGE PCB MOUNTING CONSIDERATIONS FOR THE LM4890LD

The LM4890LD's exposed-DAP (die attach paddle) package (LD) provides a low thermal resistance between the die and the PCB to which the part is mounted and soldered. The LM4890LD package should have its DAP soldered to the grounded copper pad (heatsink) under the LM4890LD (the NC pins, no connect, and ground pins should also be directly connected to this copper pad-heatsink area). The area of the copper pad (heatsink) can be determined from the LD Power Derating graph. If the multiple layer copper heatsink areas are used, then these inner layer or backside copper heatsink areas should be connected to each other with 4 (2 x 2) vias. The diameter for these vias should be between 0.013 inches and 0.02 inches with a 0.050inch pitch-spacing. Ensure efficient thermal conductivity by plating through and solder-filling the vias. Further detailed information concerning PCB layout, fabrication, and mounting an LLP package is available from National Semiconductor's Package Engineering Group under application note AN1187.

## POWER DISSIPATION

Power dissipation is a major concern when designing a successful amplifier, whether the amplifier is bridged or single-ended. A direct consequence of the increased power delivered to the load by a bridge amplifier is an increase in internal power dissipation. Since the LM4890 has two operational amplifiers in one package, the maximum internal power dissipation is 4 times that of a single-ended amplifier. The maximum power dissipation for a given application can be derived from the power dissipation graphs or from Equation 1.

$$P_{DMAX} = 4 \cdot (V_{DD})^2 / (2\pi^2 R_L) \quad (1) \quad (2)$$

It is critical that the maximum junction temperature  $T_{JMAX}$  of 150°C is not exceeded.  $T_{JMAX}$  can be determined from the power derating curves by using  $P_{DMAX}$  and the PC board foil area. By adding additional copper foil, the thermal resistance of the application can be reduced, resulting in higher  $P_{DMAX}$ . Additional copper foil can be added to any of the leads connected to the LM4890. Refer to the **APPLICATION INFORMATION** on the LM4890 reference design board for an example of good heat sinking. If  $T_{JMAX}$  still exceeds 150°C, then additional changes must be made. These changes can include reduced supply voltage, higher load impedance, or reduced ambient temperature. Internal power dissipation is a function of output power. Refer to the **Typical Performance Characteristics** curves for power dissipation information for different output powers and output loading.

## POWER SUPPLY BYPASSING

As with any amplifier, proper supply bypassing is critical for low noise performance and high power supply rejection. The capacitor location on both the bypass and power supply pins should be as close to the device as possible. Typical applications employ a 5V regulator with 10  $\mu$ F tantalum or electrolytic capacitor and a ceramic bypass capacitor which aid in supply stability. This does not eliminate the need for bypassing the supply nodes of the LM4890. The selection of a bypass capacitor, especially  $C_{BYPASS}$ , is dependent upon PSRR requirements, click and pop performance (as explained in the section, **Proper Selection of External Components**), system cost, and size constraints.

## SHUTDOWN FUNCTION

In order to reduce power consumption while not in use, the LM4890 contains a shutdown pin to externally turn off the amplifier's bias circuitry. This shutdown feature turns the amplifier off when a logic low is placed on the shutdown pin. By switching the shutdown pin to ground, the LM4890 supply current draw will be minimized in idle mode. While the device will be disabled with shutdown pin voltages less than 0.5V<sub>DC</sub>, the idle current may be greater than the typical value of 0.1 $\mu$ A. (Idle current is measured with the shutdown pin grounded).

In many applications, a microcontroller or microprocessor output is used to control the shutdown circuitry to provide a quick, smooth transition into shutdown. Another solution is to use a single-pole, single-throw switch in conjunction with an external pull-up resistor. When the switch is closed, the shutdown pin is connected to ground and disables the amplifier. If the switch is open, then the external pull-up resistor will enable the LM4890. This scheme guarantees that the shutdown pin will not float thus preventing unwanted state changes.

## SHUTDOWN OUTPUT IMPEDANCE

For  $R_f = 20k$  ohms:

$$Z_{OUT1} \text{ (between Out1 and GND)} = 10k || 50k || R_f = 6k\Omega$$

$$Z_{OUT2} \text{ (between Out2 and GND)} = 10k \parallel (40k + (10k \parallel R_f)) = 8.3k\Omega$$

$$Z_{OUT1-2} \text{ (between Out1 and Out2)} = 40k \parallel (10k + (10k \parallel R_f)) = 11.7k\Omega$$

The -3dB roll off for these measurements is 600kHz

## PROPER SELECTION OF EXTERNAL COMPONENTS

Proper selection of external components in applications using integrated power amplifiers is critical to optimize device and system performance. While the LM4890 is tolerant of external component combinations, consideration to component values must be used to maximize overall system quality.

The LM4890 is unity-gain stable which gives the designer maximum system flexibility. The LM4890 should be used in low gain configurations to minimize THD+N values, and maximize the signal to noise ratio. Low gain configurations require large input signals to obtain a given output power. Input signals equal to or greater than 1V<sub>rms</sub> are available from sources such as audio codecs. Please refer to the section, **Audio Power Amplifier Design**, for a more complete explanation of proper gain selection.

Besides gain, one of the major considerations is the closed-loop bandwidth of the amplifier. To a large extent, the bandwidth is dictated by the choice of external components shown in [Figure 13](#). The input coupling capacitor, C<sub>IN</sub>, forms a first order high pass filter which limits low frequency response. This value should be chosen based on needed frequency response for a few distinct reasons.

### Selection Of Input Capacitor Size

Large input capacitors are both expensive and space hungry for portable designs. Clearly, a certain sized capacitor is needed to couple in low frequencies without severe attenuation. But in many cases the speakers used in portable systems, whether internal or external, have little ability to reproduce signals below 100Hz to 150Hz. Thus, using a large input capacitor may not increase actual system performance.

In addition to system cost and size, click and pop performance is effected by the size of the input coupling capacitor, C<sub>IN</sub>. A larger input coupling capacitor requires more charge to reach its quiescent DC voltage (nominally 1/2 V<sub>DD</sub>). This charge comes from the output via the feedback and is apt to create pops upon device enable. Thus, by minimizing the capacitor size based on necessary low frequency response, turn-on pops can be minimized.

Besides minimizing the input capacitor size, careful consideration should be paid to the bypass capacitor value. Bypass capacitor, C<sub>BYPASS</sub>, is the most critical component to minimize turn-on pops since it determines how fast the LM4890 turns on. The slower the LM4890's outputs ramp to their quiescent DC voltage (nominally 1/2V<sub>DD</sub>), the smaller the turn-on pop. Choosing C<sub>BYPASS</sub> equal to 1.0μF along with a small value of C<sub>IN</sub>, (in the range of 0.1μF to 0.39μF), should produce a virtually clickless and popless shutdown function. While the device will function properly, (no oscillations or motorboating), with C<sub>BYPASS</sub> equal to 0.1μF, the device will be much more susceptible to turn-on clicks and pops. Thus, a value of C<sub>BYPASS</sub> equal to 1.0μF is recommended in all but the most cost sensitive designs.

## AUDIO POWER AMPLIFIER DESIGN

### A 1W/8Ω Audio Amplifier

Given:	
Power Output	1 W <sub>rms</sub>
Load Impedance	8Ω
Input Level	1 V <sub>rms</sub>
Input Impedance	20 kΩ
Bandwidth	100 Hz–20 kHz ± 0.25 dB

A designer must first determine the minimum supply rail to obtain the specified output power. By extrapolating from the Output Power vs Supply Voltage graphs in the **Typical Performance Characteristics** section, the supply rail can be easily found. A second way to determine the minimum supply rail is to calculate the required  $V_{\text{opeak}}$  using Equation 2 and add the output voltage. Using this method, the minimum supply voltage would be  $(V_{\text{opeak}} + (V_{\text{ODTOP}} + V_{\text{ODBOT}}))$ , where  $V_{\text{ODBOT}}$  and  $V_{\text{ODTOP}}$  are extrapolated from the Dropout Voltage vs Supply Voltage curve in the **Typical Performance Characteristics** section.

$$V_{\text{opeak}} = \sqrt{(2R_L P_O)} \quad (2)$$

5V is a standard voltage which in most applications is chosen for the supply rail. Extra supply voltage creates headroom that allows the LM4890 to reproduce peaks in excess of 1W without producing audible distortion. At this time, the designer must make sure that the power supply choice along with the output impedance does not violate the conditions explained in the **Power Dissipation** section.

Once the power dissipation equations have been addressed, the required differential gain can be determined from Equation 3.

$$A_{VD} \geq \sqrt{(P_O R_L)} / (V_{IN}) = V_{\text{orms}} / V_{\text{inrms}} \quad (3)$$

$$R_f / R_{IN} = A_{VD} / 2 \quad (5)$$

From Equation 3, the minimum  $A_{VD}$  is 2.83; use  $A_{VD} = 3$ .

Since the desired input impedance is 20 k $\Omega$ , and with an  $A_{VD}$  gain of 3, a ratio of 1.5:1 of  $R_f$  to  $R_{IN}$  results in an allocation of  $R_{IN} = 20$  k $\Omega$  and  $R_f = 30$  k $\Omega$ . The final design step is to address the bandwidth requirements which must be stated as a pair of  $-3$  dB frequency points. Five times away from a  $-3$  dB point is 0.17 dB down from passband response which is better than the required  $\pm 0.25$  dB specified.

$$f_L = 100\text{Hz} / 5 = 20\text{Hz}$$

$$f_H = 20\text{kHz} * 5 = 100\text{kHz}$$

As stated in the **External Components** section,  $R_{IN}$  in conjunction with  $C_{IN}$  create a highpass filter.

$$C_{IN} \geq 1 / (2\pi * 20 \text{ k}\Omega * 20\text{Hz}) = 0.397\mu\text{F}; \text{ use } 0.39\mu\text{F}$$

The high frequency pole is determined by the product of the desired frequency pole,  $f_H$ , and the differential gain,  $A_{VD}$ . With a  $A_{VD} = 3$  and  $f_H = 100\text{kHz}$ , the resulting GBWP = 300kHz which is much smaller than the LM4890 GBWP of 2.5MHz. This calculation shows that if a designer has a need to design an amplifier with a higher differential gain, the LM4890 can still be used without running into bandwidth limitations.

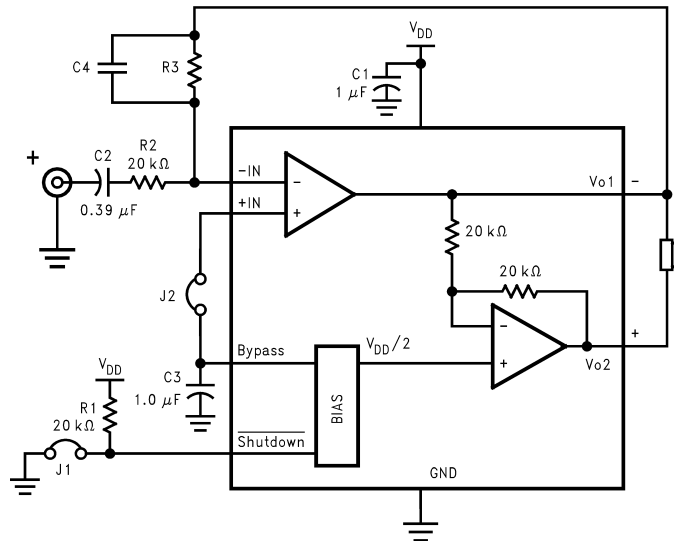

Figure 22. HIGHER GAIN AUDIO AMPLIFIER

The LM4890 is unity-gain stable and requires no external components besides gain-setting resistors, an input coupling capacitor, and proper supply bypassing in the typical application. However, if a closed-loop differential gain of greater than 10 is required, a feedback capacitor ( $C_4$ ) may be needed as shown in **Figure 2** to bandwidth limit the amplifier. This feedback capacitor creates a low pass filter that eliminates possible high frequency oscillations. Care should be taken when calculating the -3dB frequency in that an incorrect combination of  $R_3$  and  $C_4$  will cause rolloff before 20kHz. A typical combination of feedback resistor and capacitor that will not produce audio band high frequency rolloff is  $R_3 = 20\text{k}\Omega$  and  $C_4 = 25\text{pf}$ . These components result in a -3dB point of approximately 320 kHz.

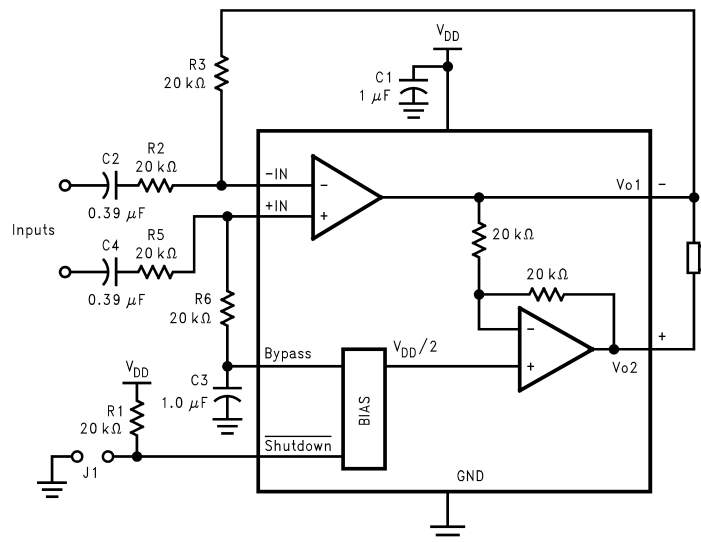

Figure 23. DIFFERENTIAL AMPLIFIER CONFIGURATION FOR LM4890

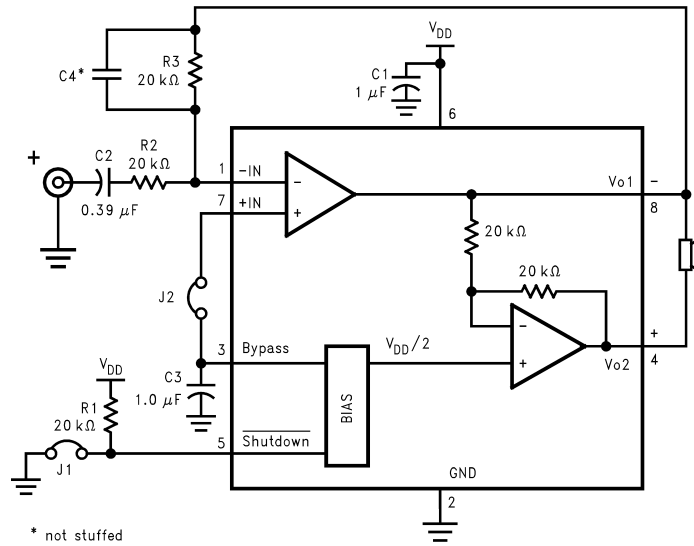

Figure 24. REFERENCE DESIGN BOARD and LAYOUT - micro SMD

LM4890 micro SMD BOARD ARTWORK

Figure 25. Silk Screen

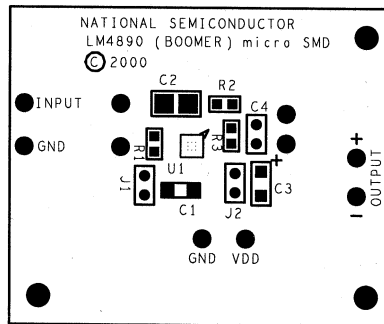
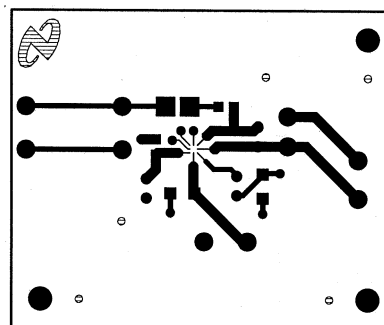
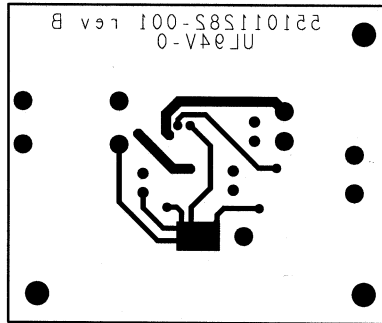

Figure 26. Top Layer

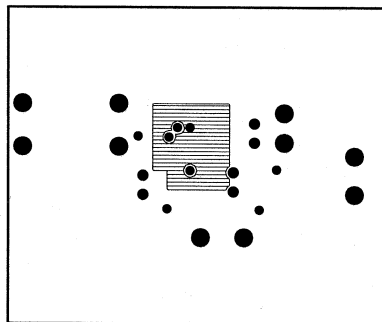



**Figure 27. Bottom Layer**



**Figure 28. Inner Layer  $V_{DD}$**



**Figure 29. Inner Layer Ground**

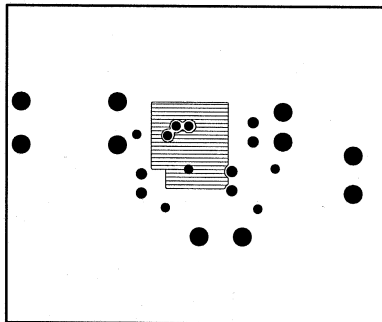

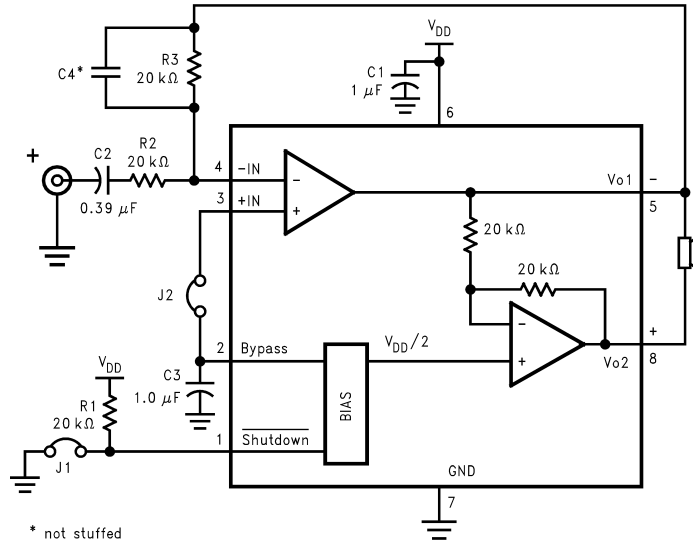

Figure 30. REFERENCE DESIGN BOARD and PCB LAYOUT GUIDELINES - MSOP & SO Boards

LM4890 SO DEMO BOARD ARTWORK

Figure 31. Silk Screen

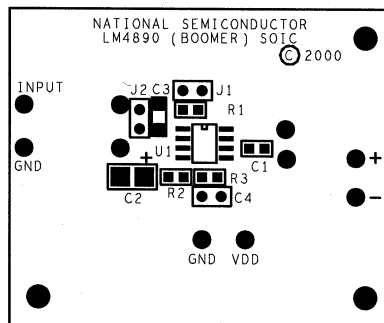

Figure 32. Top Layer

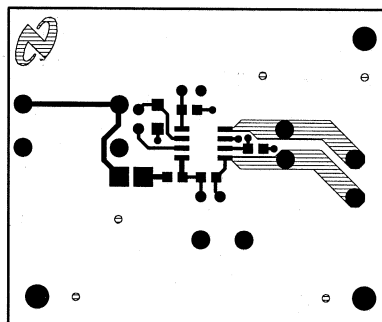
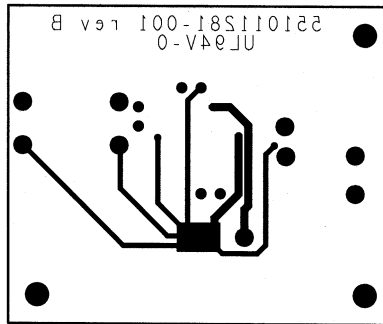

Figure 33. Bottom Layer



LM4890 MSOP DEMO BOARD ARTWORK

Figure 34. Silk Screen

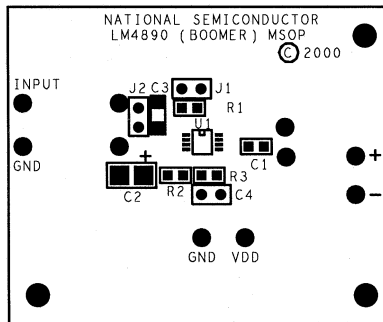

Figure 35. Top Layer

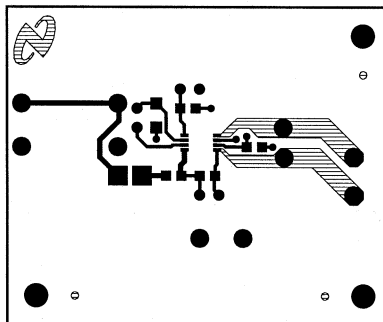

Figure 36. Bottom Layer

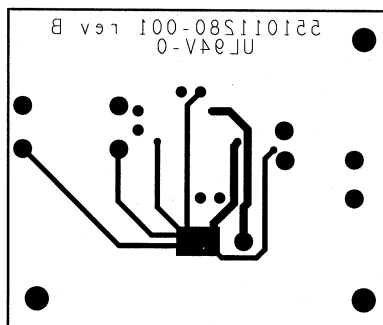

Table 2. Mono LM4890 Reference Design Boards

**Table 2. Mono LM4890 Reference Design Boards  
Bill of Material for all 3 Demo Boards (continued)**

**Bill of Material for all 3 Demo Boards**

Item	Part Number	Part Description	Qty	Ref Designator
1	551011208-001	LM4890 Mono Reference Design Board	1	
10	482911183-001	LM4890 Audio AMP	1	U1
20	151911207-001	Tant Cap 1uF 16V 10	1	C1
21	151911207-002	Cer Cap 0.39uF 50V Z5U 20% 1210	1	C2
25	152911207-001	Tant Cap 1uF 16V 10	1	C3
30	472911207-001	Res 20K Ohm 1/10W 5	3	R1, R2, R3
35	210007039-002	Jumper Header Vertical Mount 2X1 0.100	2	J1, J2

## PCB LAYOUT GUIDELINES

This section provides practical guidelines for mixed signal PCB layout that involves various digital/analog power and ground traces. Designers should note that these are only "rule-of-thumb" recommendations and the actual results will depend heavily on the final layout.

### GENERAL MIXED SIGNAL LAYOUT RECOMMENDATIONS

#### Power and Ground Circuits

For 2 layer mixed signal design, it is important to isolate the digital power and ground trace paths from the analog power and ground trace paths. Star trace routing techniques (bringing individual traces back to a central point rather than daisy chaining traces together in a serial manner) can have a major impact on low level signal performance. Star trace routing refers to using individual traces to feed power and ground to each circuit or even device. This technique will require a greater amount of design time but will not increase the final price of the board. The only extra parts required will be some jumpers.

#### Single-Point Power / Ground Connections

The analog power traces should be connected to the digital traces through a single point (link). A "Pi-filter" can be helpful in minimizing High Frequency noise coupling between the analog and digital sections. It is further recommended to put digital and analog power traces over the corresponding digital and analog ground traces to minimize noise coupling.

#### Placement of Digital and Analog Components

All digital components and high-speed digital signals traces should be located as far away as possible from analog components and circuit traces.

#### Avoiding Typical Design / Layout Problems

Avoid ground loops or running digital and analog traces parallel to each other (side-by-side) on the same PCB layer. When traces must cross over each other do it at 90 degrees. Running digital and analog traces at 90 degrees to each other from the top to the bottom side as much as possible will minimize capacitive noise coupling and cross talk.

**PACKAGING INFORMATION**

Orderable Device	Status (1)	Package Type	Package Drawing	Pins	Package Qty	Eco Plan (2)	Lead/Ball Finish	MSL Peak Temp (3)	Op Temp (°C)	Top-Side Markings (4)	Samples
LM4890ITLX/NOPB	ACTIVE	DSBGA	YZR	9	3000	Green (RoHS & no Sb/Br)	SNAGCU	Level-1-260C-UNLIM		G A8	<a href="#">Samples</a>
LM4890ITPX/NOPB	ACTIVE	DSBGA	YPB	8	3000	Green (RoHS & no Sb/Br)	SNAGCU	Level-1-260C-UNLIM		G D1	<a href="#">Samples</a>
LM4890LDX/NOPB	ACTIVE	WSON	NGZ	10	4500	Green (RoHS & no Sb/Br)	CU SN	Level-3-260C-168 HR	-40 to 85	L4890	<a href="#">Samples</a>
LM4890M/NOPB	ACTIVE	SOIC	D	8	95	Green (RoHS & no Sb/Br)	CU SN	Level-1-260C-UNLIM	-40 to 85	LM48 90M	<a href="#">Samples</a>
LM4890MM/NOPB	ACTIVE	VSSOP	DGK	8	1000	Green (RoHS & no Sb/Br)	CU SN	Level-1-260C-UNLIM	-40 to 85	G90	<a href="#">Samples</a>
LM4890MMX/NOPB	ACTIVE	VSSOP	DGK	8	3500	Green (RoHS & no Sb/Br)	CU SN	Level-1-260C-UNLIM	-40 to 85	G90	<a href="#">Samples</a>
LM4890MX/NOPB	ACTIVE	SOIC	D	8	2500	Green (RoHS & no Sb/Br)	CU SN	Level-1-260C-UNLIM	-40 to 85	LM48 90M	<a href="#">Samples</a>

(1) The marketing status values are defined as follows:

**ACTIVE:** Product device recommended for new designs.

**LIFEBUY:** TI has announced that the device will be discontinued, and a lifetime-buy period is in effect.

**NRND:** Not recommended for new designs. Device is in production to support existing customers, but TI does not recommend using this part in a new design.

**PREVIEW:** Device has been announced but is not in production. Samples may or may not be available.

**OBSOLETE:** TI has discontinued the production of the device.

(2) Eco Plan - The planned eco-friendly classification: Pb-Free (RoHS), Pb-Free (RoHS Exempt), or Green (RoHS & no Sb/Br) - please check <http://www.ti.com/productcontent> for the latest availability information and additional product content details.

**TBD:** The Pb-Free/Green conversion plan has not been defined.

**Pb-Free (RoHS):** TI's terms "Lead-Free" or "Pb-Free" mean semiconductor products that are compatible with the current RoHS requirements for all 6 substances, including the requirement that lead not exceed 0.1% by weight in homogeneous materials. Where designed to be soldered at high temperatures, TI Pb-Free products are suitable for use in specified lead-free processes.

**Pb-Free (RoHS Exempt):** This component has a RoHS exemption for either 1) lead-based flip-chip solder bumps used between the die and package, or 2) lead-based die adhesive used between the die and leadframe. The component is otherwise considered Pb-Free (RoHS compatible) as defined above.

**Green (RoHS & no Sb/Br):** TI defines "Green" to mean Pb-Free (RoHS compatible), and free of Bromine (Br) and Antimony (Sb) based flame retardants (Br or Sb do not exceed 0.1% by weight in homogeneous material)

(3) MSL, Peak Temp. -- The Moisture Sensitivity Level rating according to the JEDEC industry standard classifications, and peak solder temperature.

(4) Only one of markings shown within the brackets will appear on the physical device.

**Important Information and Disclaimer:** The information provided on this page represents TI's knowledge and belief as of the date that it is provided. TI bases its knowledge and belief on information provided by third parties, and makes no representation or warranty as to the accuracy of such information. Efforts are underway to better integrate information from third parties. TI has taken and continues to take reasonable steps to provide representative and accurate information but may not have conducted destructive testing or chemical analysis on incoming materials and chemicals. TI and TI suppliers consider certain information to be proprietary, and thus CAS numbers and other limited information may not be available for release.

In no event shall TI's liability arising out of such information exceed the total purchase price of the TI part(s) at issue in this document sold by TI to Customer on an annual basis.

**TAPE AND REEL INFORMATION**

**QUADRANT ASSIGNMENTS FOR PIN 1 ORIENTATION IN TAPE**

\*All dimensions are nominal

Device	Package Type	Package Drawing	Pins	SPQ	Reel Diameter (mm)	Reel Width W1 (mm)	A0 (mm)	B0 (mm)	K0 (mm)	P1 (mm)	W (mm)	Pin1 Quadrant
LM4890ITLX/NOPB	DSBGA	YZR	9	3000	178.0	8.4	1.7	1.7	0.76	4.0	8.0	Q1
LM4890ITPX/NOPB	DSBGA	YPB	8	3000	178.0	8.4	1.5	1.5	0.66	4.0	8.0	Q1
LM4890LDX/NOPB	WSON	NGZ	10	4500	330.0	12.4	4.3	3.3	1.0	8.0	12.0	Q1
LM4890MM/NOPB	VSSOP	DGK	8	1000	178.0	12.4	5.3	3.4	1.4	8.0	12.0	Q1
LM4890MMX/NOPB	VSSOP	DGK	8	3500	330.0	12.4	5.3	3.4	1.4	8.0	12.0	Q1
LM4890MX/NOPB	SOIC	D	8	2500	330.0	12.4	6.5	5.4	2.0	8.0	12.0	Q1

**TAPE AND REEL BOX DIMENSIONS**

\*All dimensions are nominal

Device	Package Type	Package Drawing	Pins	SPQ	Length (mm)	Width (mm)	Height (mm)
LM4890ITLX/NOPB	DSBGA	YZR	9	3000	210.0	185.0	35.0
LM4890ITPX/NOPB	DSBGA	YPB	8	3000	210.0	185.0	35.0
LM4890LDX/NOPB	WSON	NGZ	10	4500	358.0	343.0	63.0
LM4890MM/NOPB	VSSOP	DGK	8	1000	203.0	190.0	41.0
LM4890MMX/NOPB	VSSOP	DGK	8	3500	349.0	337.0	45.0
LM4890MX/NOPB	SOIC	D	8	2500	349.0	337.0	45.0



DGK (S-PDSO-G8)

PLASTIC SMALL-OUTLINE PACKAGE



4073329/E 05/06

- NOTES:
- A. All linear dimensions are in millimeters.
  - B. This drawing is subject to change without notice.
  - C. Body length does not include mold flash, protrusions, or gate burrs. Mold flash, protrusions, or gate burrs shall not exceed 0.15 per end.
  - D. Body width does not include interlead flash. Interlead flash shall not exceed 0.50 per side.
  - E. Falls within JEDEC MO-187 variation AA, except interlead flash.

NGZ0010B

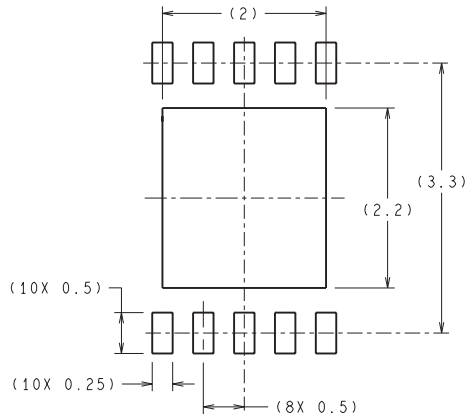

DIMENSIONS ARE IN MILLIMETERS  
DIMENSIONS IN ( ) FOR REFERENCE ONLY

**RECOMMENDED LAND PATTERN**  
1:1 RATIO WITH PKG SOLDER PADS

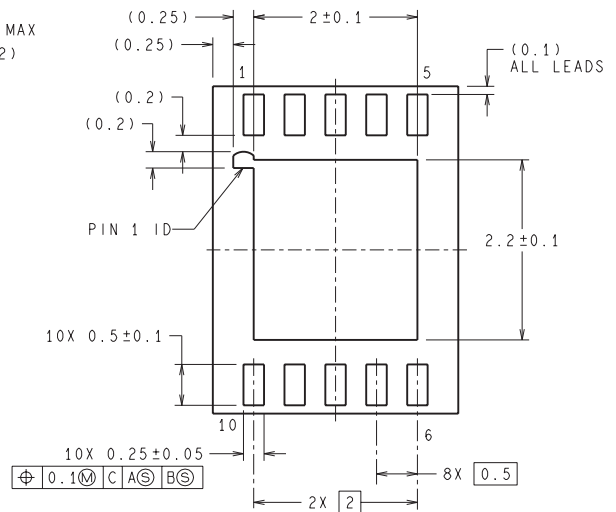
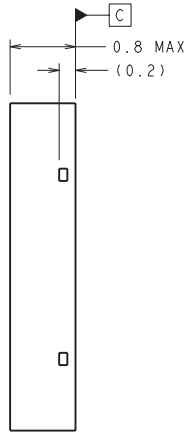
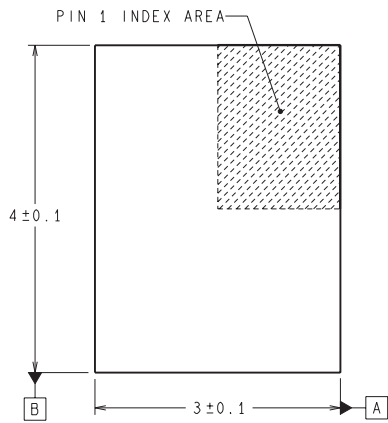

LDA10B (Rev B)

D (R-PDSO-G8)

PLASTIC SMALL OUTLINE



4040047-3/M 06/11

YPB0008

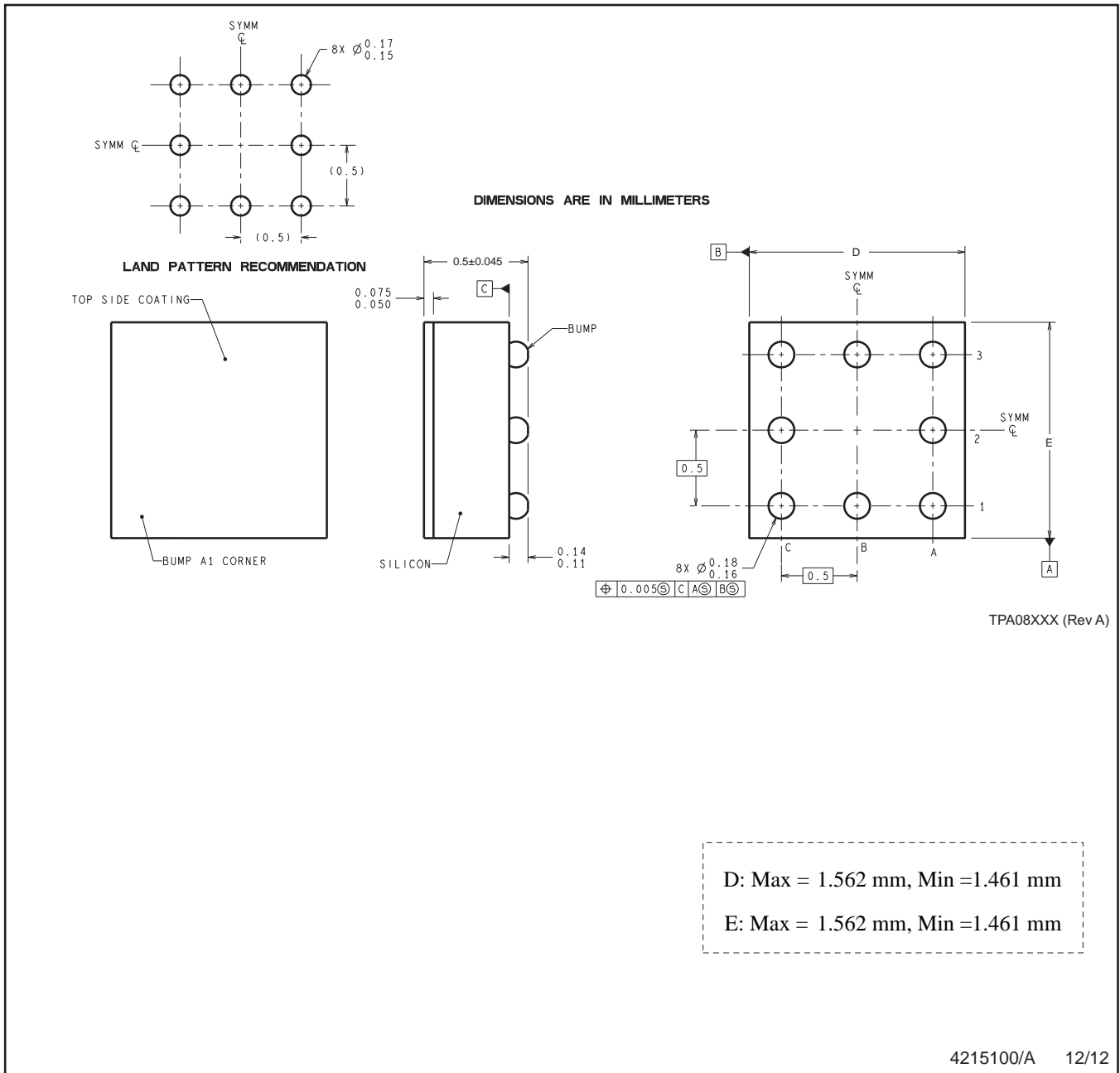

4215100/A 12/12

NOTES: A. All linear dimensions are in millimeters. Dimensioning and tolerancing per ASME Y14.5M-1994.  
 B. This drawing is subject to change without notice.

YZR0009

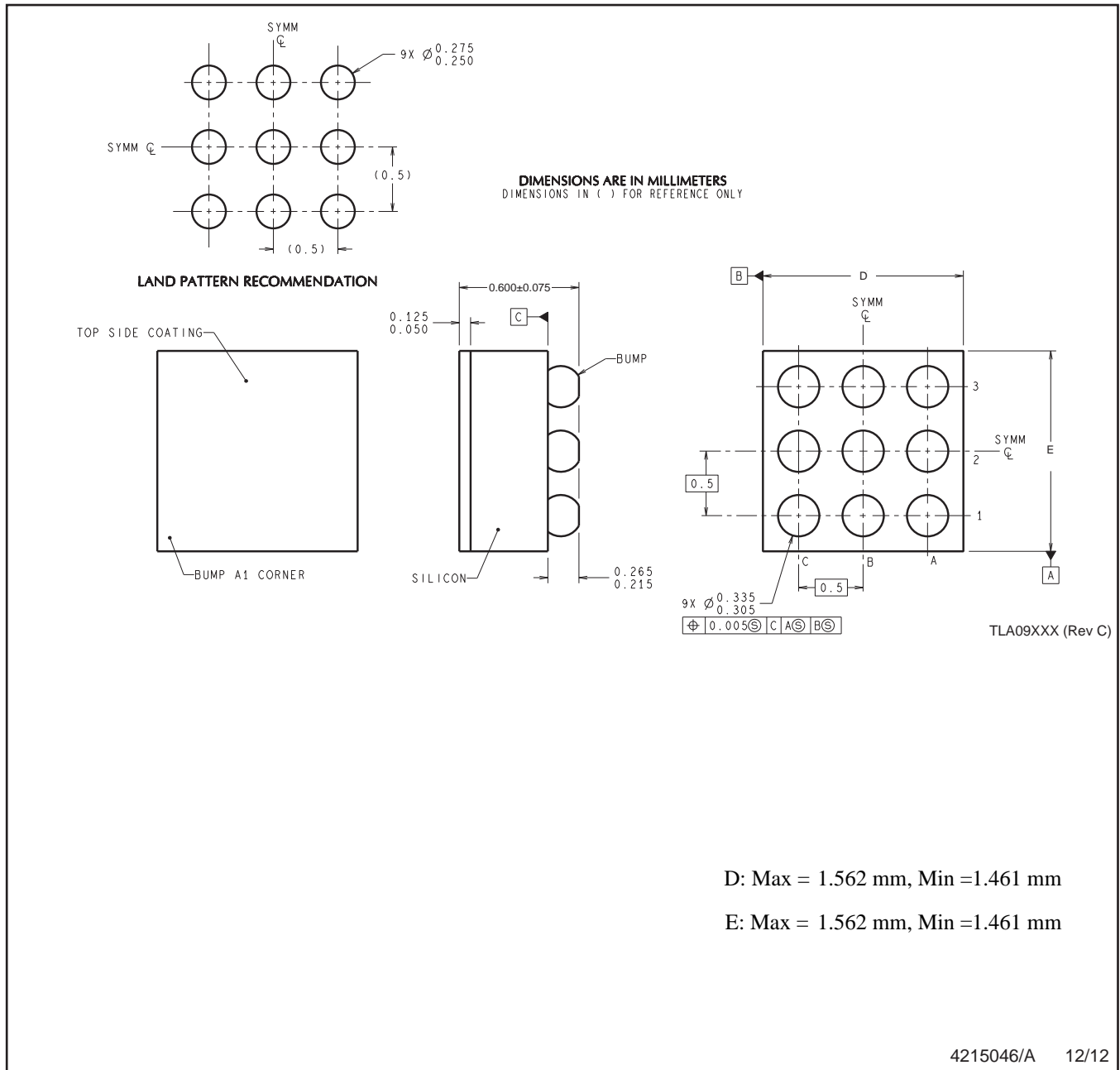

D: Max = 1.562 mm, Min =1.461 mm

E: Max = 1.562 mm, Min =1.461 mm

NOTES: A. All linear dimensions are in millimeters. Dimensioning and tolerancing per ASME Y14.5M-1994.  
B. This drawing is subject to change without notice.

## IMPORTANT NOTICE

Texas Instruments Incorporated and its subsidiaries (TI) reserve the right to make corrections, enhancements, improvements and other changes to its semiconductor products and services per JESD46, latest issue, and to discontinue any product or service per JESD48, latest issue. Buyers should obtain the latest relevant information before placing orders and should verify that such information is current and complete. All semiconductor products (also referred to herein as "components") are sold subject to TI's terms and conditions of sale supplied at the time of order acknowledgment.

TI warrants performance of its components to the specifications applicable at the time of sale, in accordance with the warranty in TI's terms and conditions of sale of semiconductor products. Testing and other quality control techniques are used to the extent TI deems necessary to support this warranty. Except where mandated by applicable law, testing of all parameters of each component is not necessarily performed.

TI assumes no liability for applications assistance or the design of Buyers' products. Buyers are responsible for their products and applications using TI components. To minimize the risks associated with Buyers' products and applications, Buyers should provide adequate design and operating safeguards.

TI does not warrant or represent that any license, either express or implied, is granted under any patent right, copyright, mask work right, or other intellectual property right relating to any combination, machine, or process in which TI components or services are used. Information published by TI regarding third-party products or services does not constitute a license to use such products or services or a warranty or endorsement thereof. Use of such information may require a license from a third party under the patents or other intellectual property of the third party, or a license from TI under the patents or other intellectual property of TI.

Reproduction of significant portions of TI information in TI data books or data sheets is permissible only if reproduction is without alteration and is accompanied by all associated warranties, conditions, limitations, and notices. TI is not responsible or liable for such altered documentation. Information of third parties may be subject to additional restrictions.

Resale of TI components or services with statements different from or beyond the parameters stated by TI for that component or service voids all express and any implied warranties for the associated TI component or service and is an unfair and deceptive business practice. TI is not responsible or liable for any such statements.

Buyer acknowledges and agrees that it is solely responsible for compliance with all legal, regulatory and safety-related requirements concerning its products, and any use of TI components in its applications, notwithstanding any applications-related information or support that may be provided by TI. Buyer represents and agrees that it has all the necessary expertise to create and implement safeguards which anticipate dangerous consequences of failures, monitor failures and their consequences, lessen the likelihood of failures that might cause harm and take appropriate remedial actions. Buyer will fully indemnify TI and its representatives against any damages arising out of the use of any TI components in safety-critical applications.

In some cases, TI components may be promoted specifically to facilitate safety-related applications. With such components, TI's goal is to help enable customers to design and create their own end-product solutions that meet applicable functional safety standards and requirements. Nonetheless, such components are subject to these terms.

No TI components are authorized for use in FDA Class III (or similar life-critical medical equipment) unless authorized officers of the parties have executed a special agreement specifically governing such use.

Only those TI components which TI has specifically designated as military grade or "enhanced plastic" are designed and intended for use in military/aerospace applications or environments. Buyer acknowledges and agrees that any military or aerospace use of TI components which have **not** been so designated is solely at the Buyer's risk, and that Buyer is solely responsible for compliance with all legal and regulatory requirements in connection with such use.

TI has specifically designated certain components as meeting ISO/TS16949 requirements, mainly for automotive use. In any case of use of non-designated products, TI will not be responsible for any failure to meet ISO/TS16949.

### Products

Audio	<a href="http://www.ti.com/audio">www.ti.com/audio</a>
Amplifiers	<a href="http://amplifier.ti.com">amplifier.ti.com</a>
Data Converters	<a href="http://dataconverter.ti.com">dataconverter.ti.com</a>
DLP® Products	<a href="http://www.dlp.com">www.dlp.com</a>
DSP	<a href="http://dsp.ti.com">dsp.ti.com</a>
Clocks and Timers	<a href="http://www.ti.com/clocks">www.ti.com/clocks</a>
Interface	<a href="http://interface.ti.com">interface.ti.com</a>
Logic	<a href="http://logic.ti.com">logic.ti.com</a>
Power Mgmt	<a href="http://power.ti.com">power.ti.com</a>
Microcontrollers	<a href="http://microcontroller.ti.com">microcontroller.ti.com</a>
RFID	<a href="http://www.ti-rfid.com">www.ti-rfid.com</a>
OMAP Applications Processors	<a href="http://www.ti.com/omap">www.ti.com/omap</a>
Wireless Connectivity	<a href="http://www.ti.com/wirelessconnectivity">www.ti.com/wirelessconnectivity</a>

### Applications

Automotive and Transportation	<a href="http://www.ti.com/automotive">www.ti.com/automotive</a>
Communications and Telecom	<a href="http://www.ti.com/communications">www.ti.com/communications</a>
Computers and Peripherals	<a href="http://www.ti.com/computers">www.ti.com/computers</a>
Consumer Electronics	<a href="http://www.ti.com/consumer-apps">www.ti.com/consumer-apps</a>
Energy and Lighting	<a href="http://www.ti.com/energy">www.ti.com/energy</a>
Industrial	<a href="http://www.ti.com/industrial">www.ti.com/industrial</a>
Medical	<a href="http://www.ti.com/medical">www.ti.com/medical</a>
Security	<a href="http://www.ti.com/security">www.ti.com/security</a>
Space, Avionics and Defense	<a href="http://www.ti.com/space-avionics-defense">www.ti.com/space-avionics-defense</a>
Video and Imaging	<a href="http://www.ti.com/video">www.ti.com/video</a>

### TI E2E Community

[e2e.ti.com](http://e2e.ti.com)