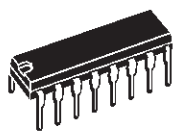




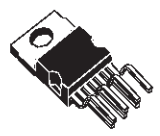
# L4962

## 1.5A POWER SWITCHING REGULATOR

- 1.5A OUTPUT CURRENT
- 5.1V TO 40V OUTPUT VOLTAGE RANGE
- PRECISE ( $\pm 2\%$ ) ON-CHIP REFERENCE
- HIGH SWITCHING FREQUENCY
- VERY HIGH EFFICIENCY (UP TO 90%)
- VERY FEW EXTERNAL COMPONENTS
- SOFT START
- INTERNAL LIMITING CURRENT
- THERMAL SHUTDOWN



**POWERDIP**  
(12 + 2 + 2)



**HEPTAWATT**

**ORDERING NUMBERS :** L4962/A (12 + 2 + 2 Powerdip)  
L4962E/A (Heptawatt Vertical)  
L4962EH/A (Horizontal Heptawatt)

### DESCRIPTION

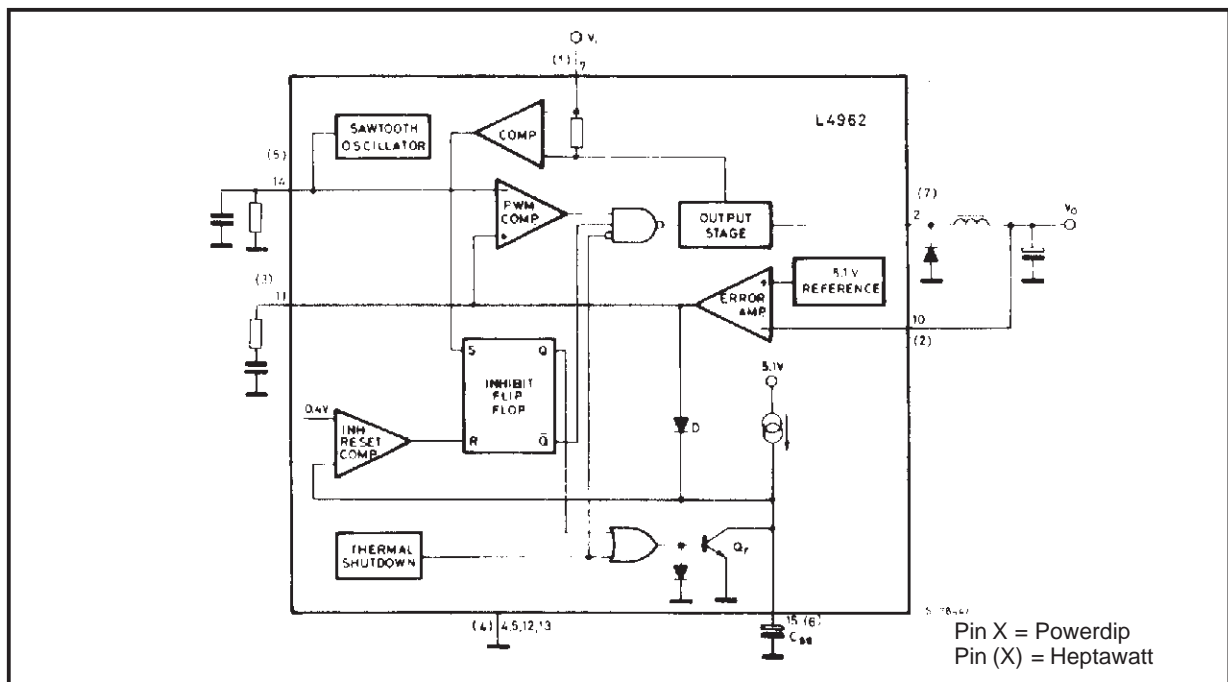
The L4962 is a monolithic power switching regulator delivering 1.5A at a voltage variable from 5V to 40V in step down configuration.

Features of the device include current limiting, soft start, thermal protection and 0 to 100% duty cycle for continuous operating mode.

The L4962 is mounted in a 16-lead Powerdip plastic package and Heptawatt package and requires very few external components.

Efficient operation at switching frequencies up to 150KHz allows a reduction in the size and cost of external filter components.

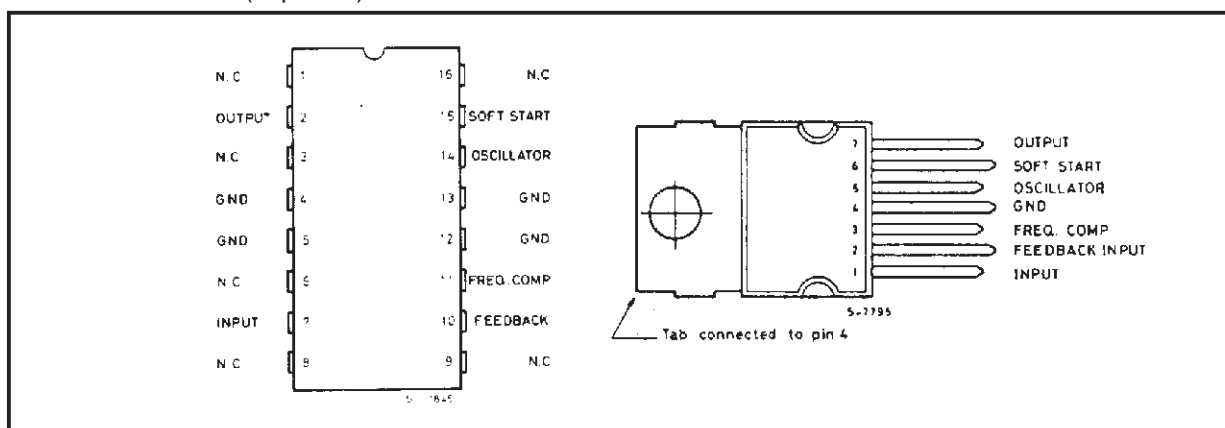
### BLOCK DIAGRAM



**ABSOLUTE MAXIMUM RATINGS**

Symbol	Parameter	Value	Unit
$V_7$	Input voltage	50	V
$V_7 - V_2$	Input to output voltage difference	50	V
$V_2$	Negative output DC voltage	-1	V
	Output peak voltage at $t = 0.1\mu s$ ; $f = 100KHz$	-5	V
$V_{11}, V_{15}$	Voltage at pin 11, 15	5.5	V
$V_{10}$	Voltage at pin 10	7	V
$I_{11}$	Pin 11 sink current	1	mA
$I_{14}$	Pin 14 source current	20	mA
$P_{tot}$	Power dissipation at $T_{pins} \leq 90^\circ C$ (Powerdip)	4.3	W
	$T_{case} \leq 90^\circ C$ (Heptawatt)	15	W
$T_j, T_{stg}$	Junction and storage temperature	-40 to 150	$^\circ C$

**PIN CONNECTION (Top view)**



**THERMAL DATA**

Symbol	Parameter		Heptawatt	Powerdip
$R_{th j-case}$	Thermal resistance junction-case	max	4 $^\circ C/W$	-
$R_{th j-pins}$	Thermal resistance junction-pins	max	-	14 $^\circ C/W$
$R_{th j-amb}$	Thermal resistance junction-ambient	max	50 $^\circ C/W$	80 $^\circ C/W^*$

\* Obtained with the GND pins soldered to printed circuit with minimized copper area.

**PIN FUNCTIONS**

HEPTAWATT	POWERDIP	NAME	FUNCTION
1	7	SUPPLY VOLTAGE	Unregulated voltage input. An internal regulator powers the internal logic.
2	10	FEEDBACK INPUT	The feedback terminal of the regulation loop. The output is connected directly to this terminal for 5.1V operation; it is connected via a divider for higher voltages.
3	11	FREQUENCY COMPENSATION	A series RC network connected between this terminal and ground determines the regulation loop gain characteristics.

## PIN FUNCTIONS (cont'd)

HEPTAWATT	POWERDIP	NAME	FUNCTION
4	4, 5, 12, 13	GROUND	Common ground terminal.
5	14	OSCILLATOR	A parallel RC network connected to this terminal determines the switching frequency. This pin must be connected to pin 7 input when the internal oscillator is used.
6	15	SOFT START	Soft start time constant. A capacitor is connected between this terminal and ground to define the soft start time constant. This capacitor also determines the average short circuit output current.
7	2	OUTPUT	Regulator output.
	1, 3, 6, 8, 9, 16		N.C.

**ELECTRICAL CHARACTERISTICS** (Refer to the test circuit,  $T_j = 25\text{ }^\circ\text{C}$ ,  $V_i = 35\text{V}$ , unless otherwise specified)

Symbol	Parameter	Test Conditions	Min.	Typ.	Max.	Unit
--------	-----------	-----------------	------	------	------	------

## DYNAMIC CHARACTERISTICS

$V_o$	Output voltage range	$V_i = 46\text{V}$	$I_o = 1\text{A}$	$V_{ref}$		40	V
$V_i$	Input voltage range	$V_o = V_{ref}$ to 36V	$I_o = 1.5\text{A}$	9		46	V
$\Delta V_o$	Line regulation	$V_i = 10\text{V}$ to 40V	$V_o = V_{ref}$ $I_o = 1\text{A}$		15	50	mV
$\Delta V_o$	Load regulation	$V_o = V_{ref}$	$I_o = 0.5\text{A}$ to 1.5A		8	20	mV
$V_{ref}$	Internal reference voltage (pin 10)	$V_i = 9\text{V}$ to 46V	$I_o = 1\text{A}$	5	5.1	5.2	V
$\frac{\Delta V_{ref}}{\Delta T}$	Average temperature coefficient of refer. voltage	$T_j = 0^\circ\text{C}$ to $125^\circ\text{C}$	$I_o = 1\text{A}$		0.4		mV/ $^\circ\text{C}$
$V_d$	Dropout voltage	$I_o = 1.5\text{A}$			1.5	2	V
$I_{om}$	Maximum operating load current	$V_i = 9\text{V}$ to 46V $V_o = V_{ref}$ to 36V		1.5			A
$I_{2L}$	Current limiting threshold (pin 2)	$V_i = 9\text{V}$ to 46V $V_o = V_{ref}$ to 36V		2		3.3	A
$I_{SH}$	Input average current	$V_i = 46\text{V}$ ; output short-circuit			15	30	mA
$\eta$	Efficiency	$f = 100\text{KHz}$	$V_o = V_{ref}$		70		%
		$I_o = 1\text{A}$	$V_o = 12\text{V}$		80		%
SVR	Supply voltage ripple rejection	$\Delta V_i = 2V_{rms}$ fripple = 100Hz $V_o = V_{ref}$	$I_o = 1\text{A}$	50	56		dB

## ELECTRICAL CHARACTERISTICS (continued)

Symbol	Parameter	Test Conditions	Min.	Typ.	Max.	Unit
--------	-----------	-----------------	------	------	------	------

## DYNAMIC CHARACTERISTICS (cont'd)

f	Switching frequency		85	100	115	KHz
$\frac{\Delta f}{\Delta V_i}$	Voltage stability of switching frequency	$V_i = 9V$ to $46V$		0.5		%
$\frac{\Delta f}{\Delta T_j}$	Temperature stability of switching frequency	$T_j = 0^\circ C$ to $125^\circ C$		1		%
$f_{max}$	Maximum operating switching frequency	$V_o = V_{ref}$ $I_o = 1A$	120	150		KHz
$T_{sd}$	Thermal shutdown junction temperature			150		$^\circ C$

## DC CHARACTERISTICS

$I_{7Q}$	Quiescent drain current	100% duty cycle pins 2 and 14 open	$V_i = 46V$		30	40	mA
		0% duty cycle			15	20	mA
$-I_{2L}$	Output leakage current	0% duty cycle				1	mA

## SOFT START

$I_{15SO}$	Source current		100	140	180	$\mu A$
$I_{15SI}$	Sink current		50	70	120	$\mu A$

## ERROR AMPLIFIER

$V_{11H}$	High level output voltage	$V_{10} = 4.7V$ $I_{11} = 100\mu A$	3.5			V
$V_{11L}$	Low level output voltage	$V_{10} = 5.3V$ $I_{11} = 100\mu A$			0.5	V
$I_{11SI}$	Sink output current	$V_{10} = 5.3V$	100	150		$\mu A$
$-I_{11SO}$	Source output current	$V_{10} = 4.7V$	100	150		$\mu A$
$I_{10}$	Input bias current	$V_{10} = 5.2V$		2	10	$\mu A$
$G_v$	DC open loop gain	$V_{11} = 1V$ to $3V$	46	55		dB

## OSCILLATOR

$-I_{14}$	Oscillator source current		5			mA
-----------	---------------------------	--	---	--	--	----

### CIRCUIT OPERATION (refer to the block diagram)

The L4962 is a monolithic stepdown switching regulator providing output voltages from 5.1V to 40V and delivering 1.5A.

The regulation loop consists of a sawtooth oscillator, error amplifier, comparator and the output stage. An error signal is produced by comparing the output voltage with a precise 5.1V on-chip reference (zener zap trimmed to  $\pm 2\%$ ).

This error signal is then compared with the sawtooth signal to generate the fixed frequency pulse width modulated pulses which drive the output stage.

The gain and frequency stability of the loop can be adjusted by an external RC network connected to pin 11. Closing the loop directly gives an output voltage of 5.1V. Higher voltages are obtained by inserting a voltage divider.

Output overcurrents at switch on are prevented by the soft start function. The error amplifier output is initially clamped by the external capacitor  $C_{SS}$  and

allowed to rise, linearly, as this capacitor is charged by a constant current source. Output overload protection is provided in the form of a current limiter.

The load current is sensed by an internal metal resistor connected to a comparator. When the load current exceeds a preset threshold this comparator sets a flip flop which disables the output stage and discharges the soft start capacitor. A second comparator resets the flip flop when the voltage across the soft start capacitor has fallen to 0.4V.

The output stage is thus re-enabled and the output voltage rises under control of the soft start network. If the overload condition is still present the limiter will trigger again when the threshold current is reached. The average short circuit current is limited to a safe value by the dead time introduced by the soft start network. The thermal overload circuit disables circuit operation when the junction temperature reaches about 150°C and has hysteresis to prevent unstable conditions.

Figure 1. Soft start waveforms

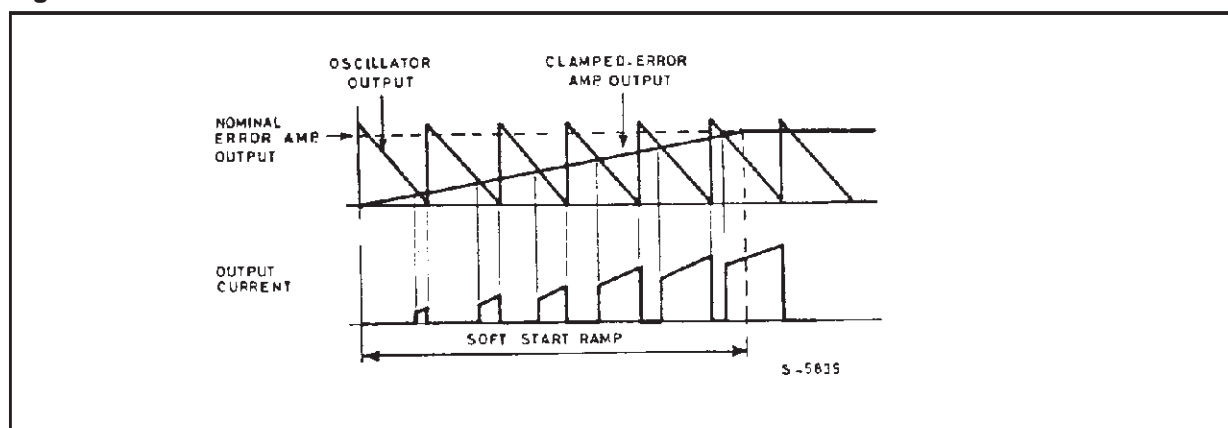


Figure 2. Current limiter waveforms

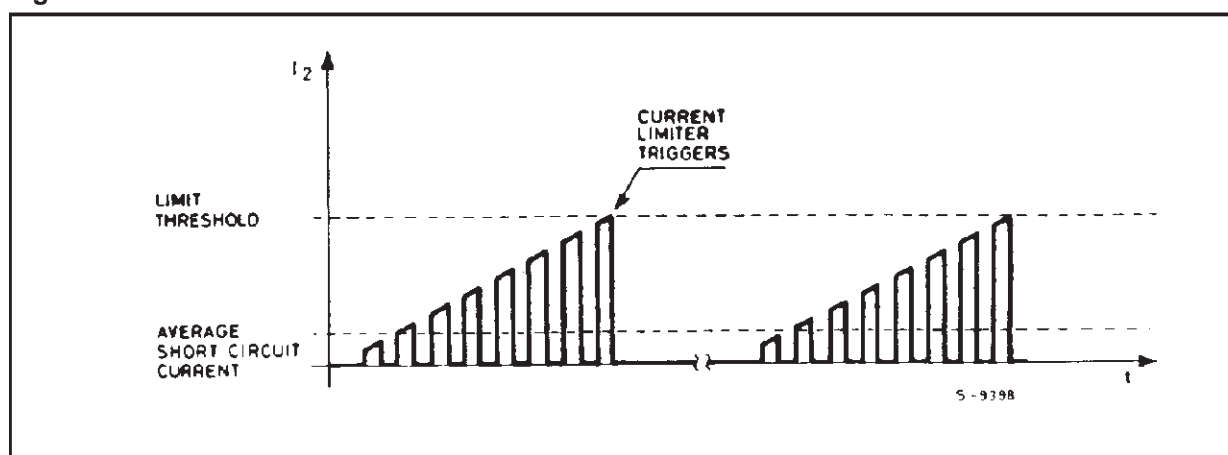


Figure 3. Test and application circuit (Powerdip)

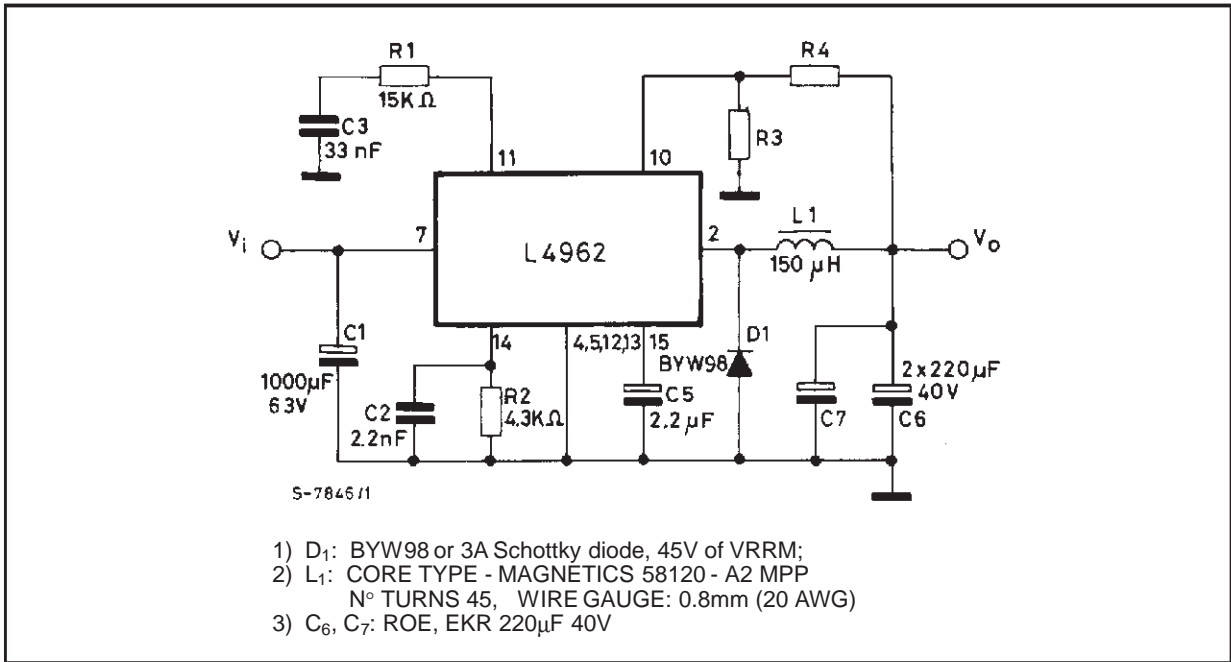


Figure 4. Quiescent drain current vs. supply voltage (0% duty cycle)

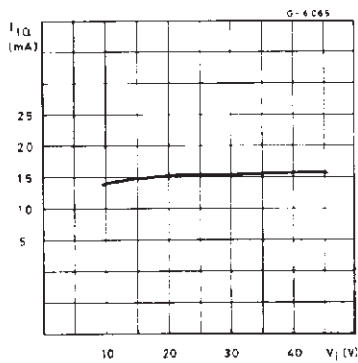


Figure 5. Quiescent drain current vs. supply voltage (100% duty cycle)

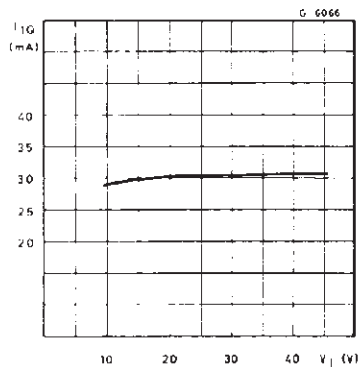


Figure 6. Quiescent drain current vs. junction temperature (0% duty cycle)

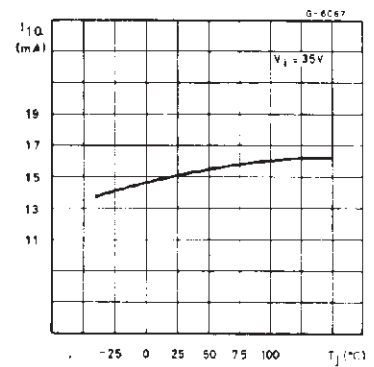


Figure 7. Quiescent drain current vs. junction temperature (100% duty cycle)

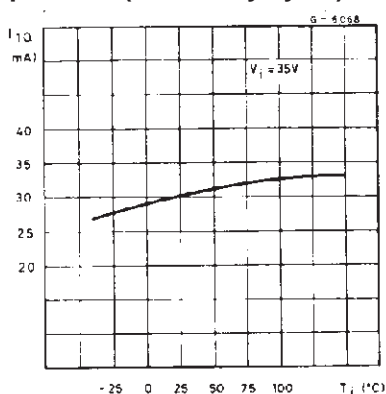


Figure 8. Reference voltage (pin 10) vs.  $V_i$  rdip vs.  $V_i$

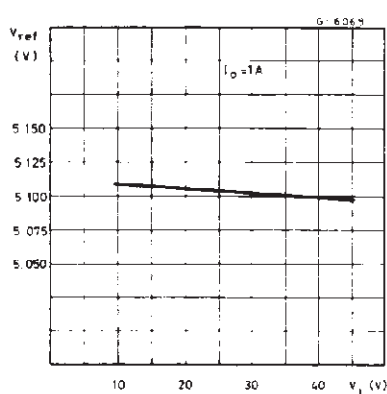


Figure 9. Reference voltage (pin 10) vs. junction temperature

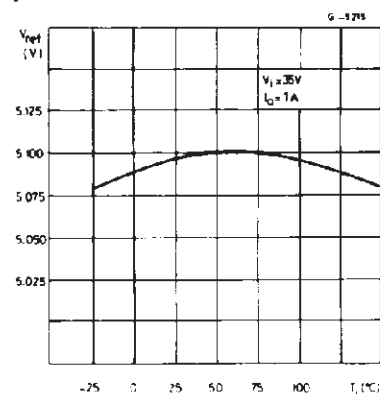


Figure 10. Open loop frequency and phase response of error amplifier

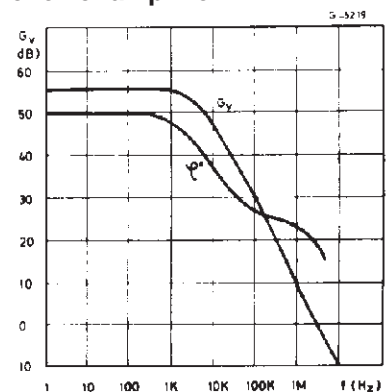


Figure 11. Switching frequency vs. input voltage

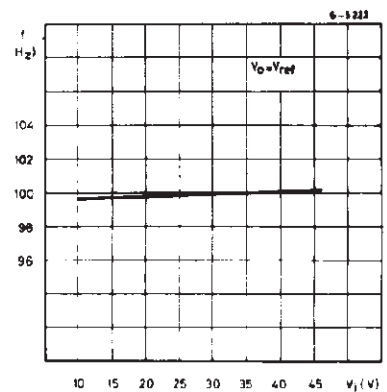


Figure 12. Switching frequency vs. junction temperature

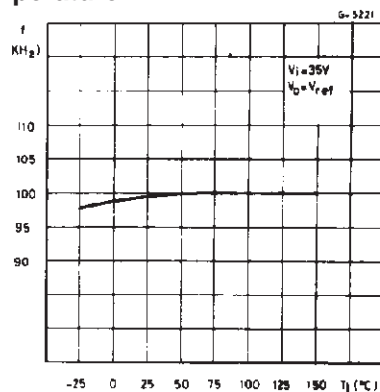


Figure 13. Switching frequency vs. R2 (see test circuit)

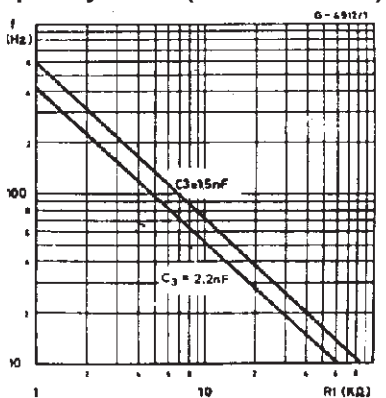


Figure 14. Line transient response

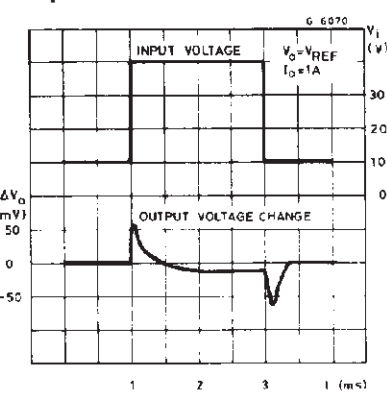


Figure 15. Load transient response

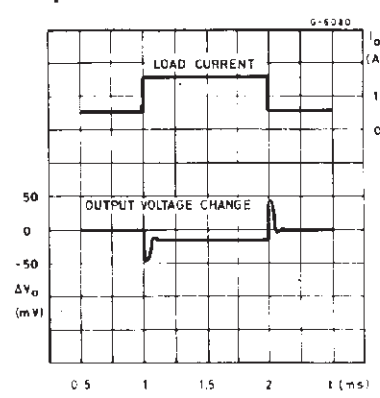


Figure 16. Supply voltage ripple rejection vs. frequency

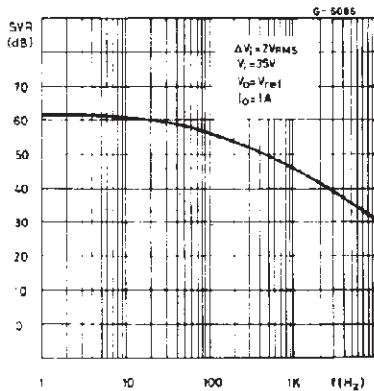


Figure 17. Dropout voltage between pin 7 and pin 2 vs. current at pin 2

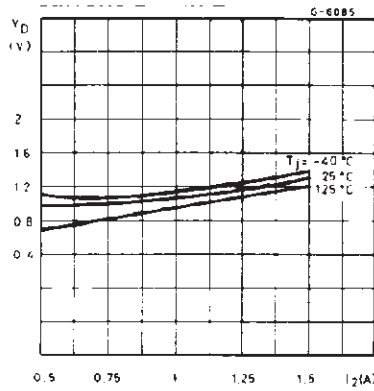


Figure 18. Dropout voltage between pin 7 and 2 vs. junction temperature

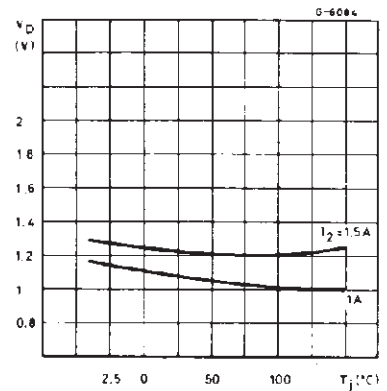


Figure 19. Efficiency vs. output current

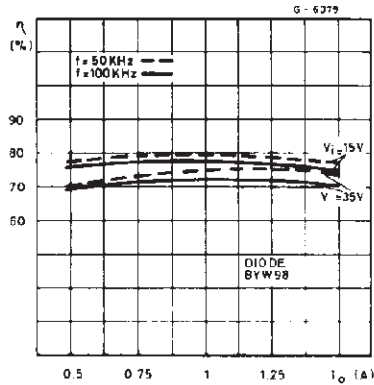


Figure 20. Efficiency vs. output current

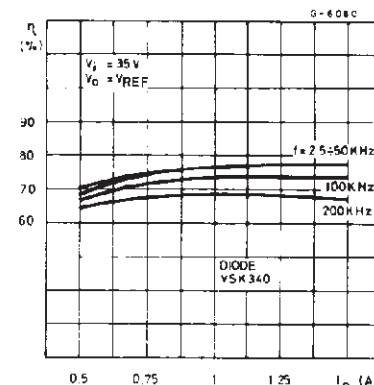


Figure 21. Efficiency vs. output current

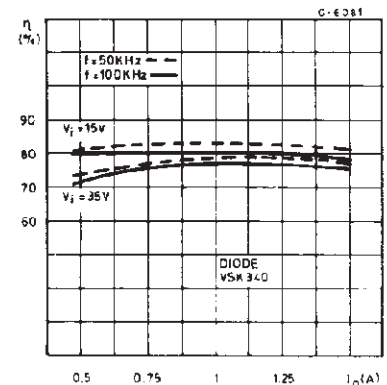


Figure 22. Efficiency vs. output voltage

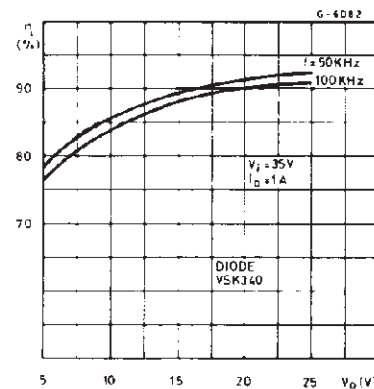


Figure 23. Efficiency vs. output voltage

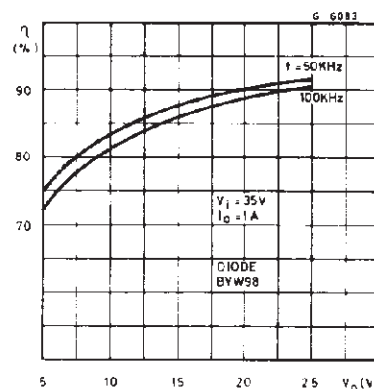
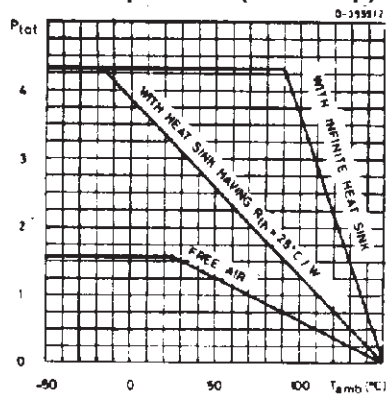


Figure 24. Maximum allowable power dissipation vs. ambient temperature (Powerdip)





APPLICATION INFORMATION

Figure 25. Typical application circuit

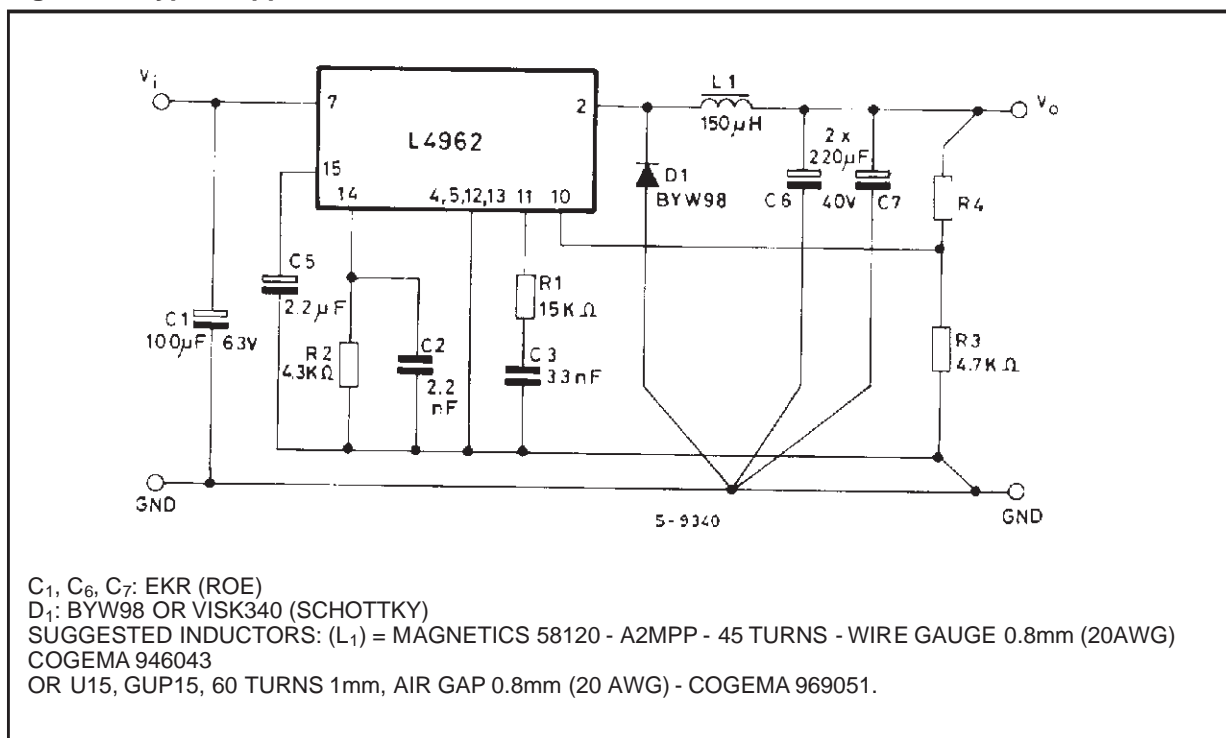
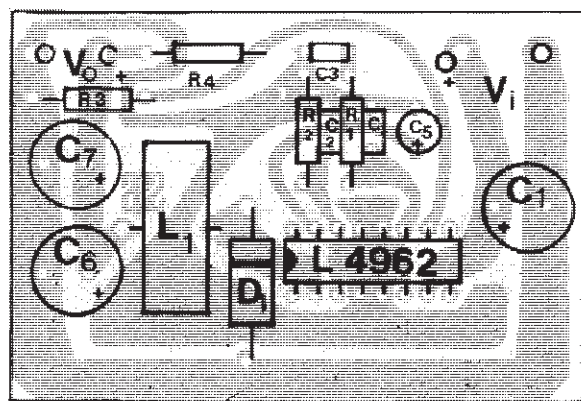


Figure 26. P.C. board and component layout of the circuit of Fig. 25 (1 : 1 scale)



Resistor values for standard output 7 voltages		
V <sub>o</sub>	R3	R4
12V	4.7KΩ	6.2KΩ
15V	4.7KΩ	9.1KΩ
18V	4.7KΩ	12KΩ
24V	4.7KΩ	18KΩ

APPLICATION INFORMATION (continued)

Figure 27. - A minimal 5.1V fixed regulator; Very few component are required

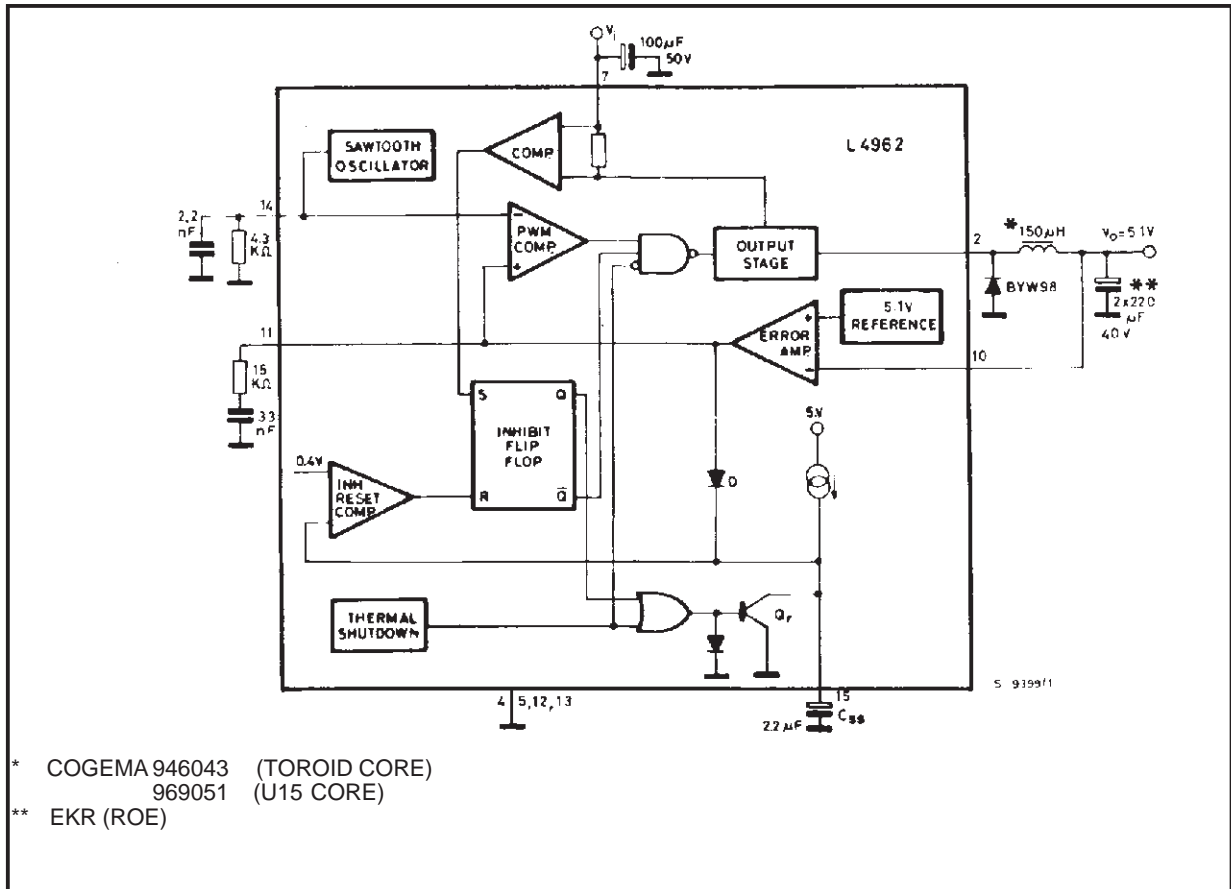
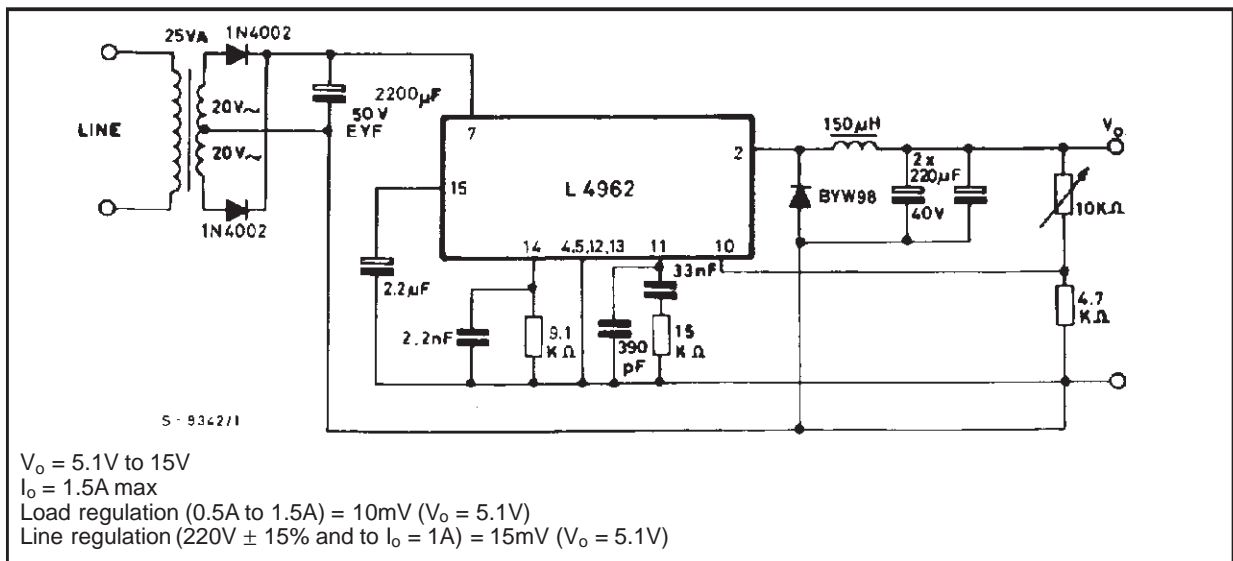


Figure 28. Programmable power supply



APPLICATION INFORMATION (continued)

Figure 29. DC-DC converter 5.1V/4A, ± 12V/1A. A suggestion how to synchronize a negative output

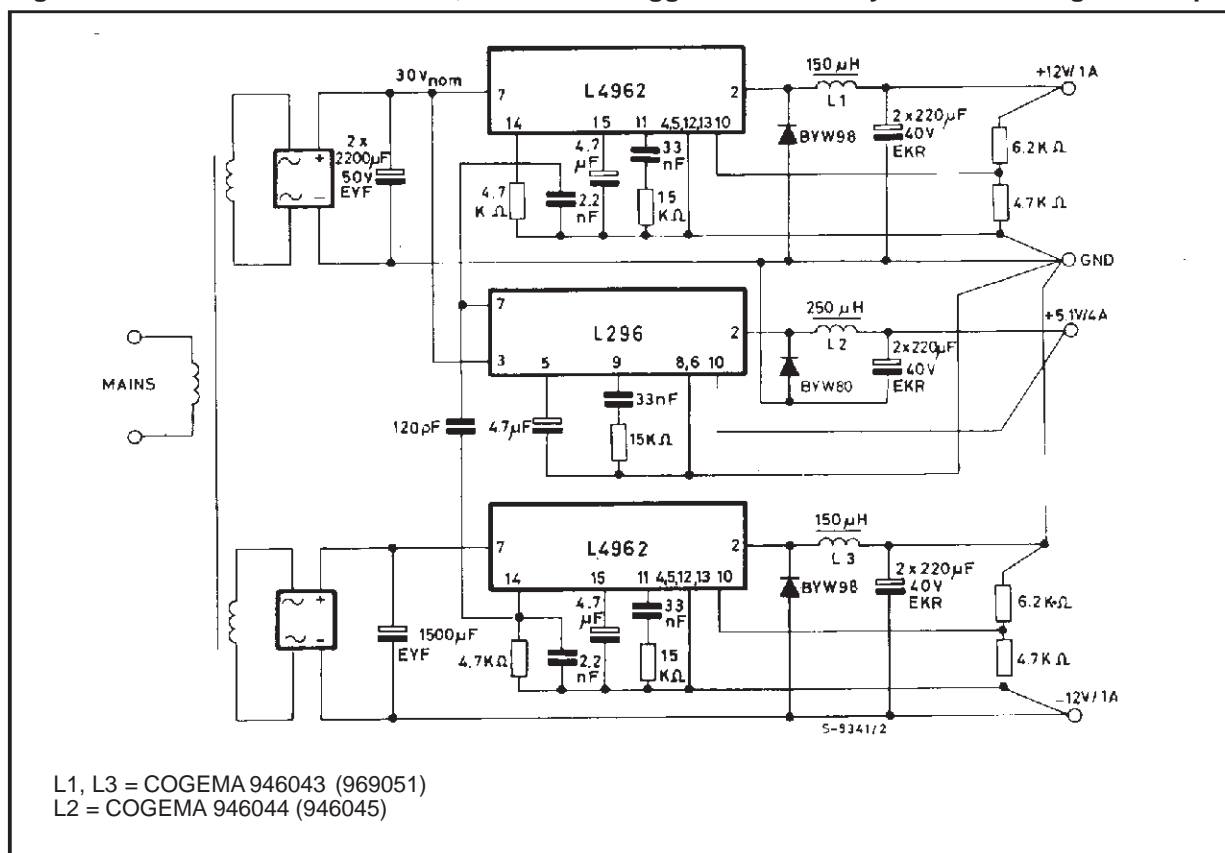


Figure 30. In multiple supplies several L4962s can be synchronized as shown

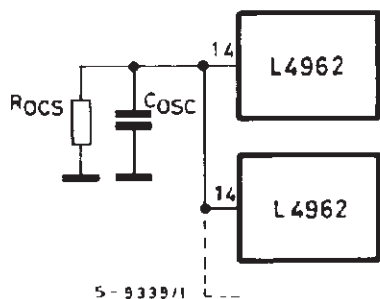
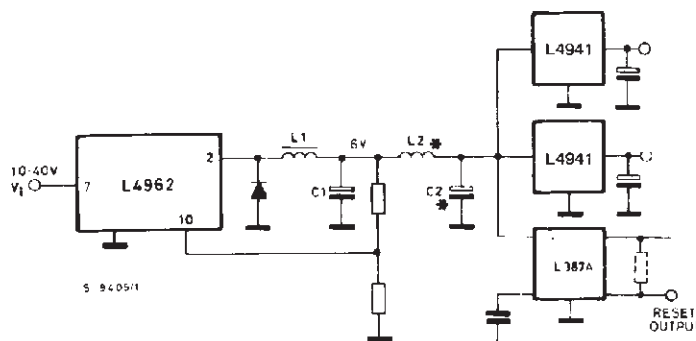


Figure 31. Preregulator for distributed supplies



\* L2 and C2 are necessary to reduce the switching frequency spikes when linear regulators are remote from L4962

**MOUNTING INSTRUCTION**

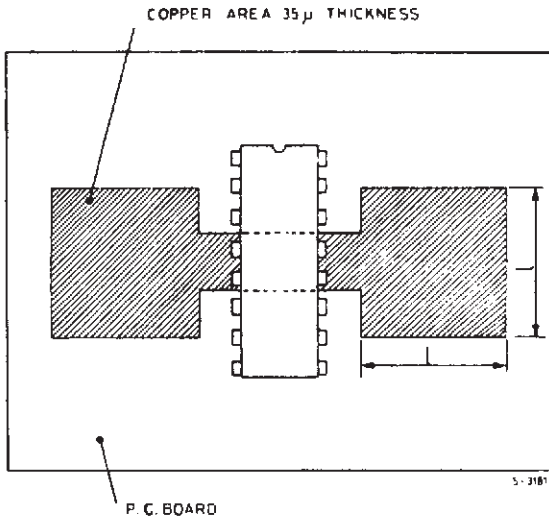
The  $R_{th-j-amb}$  of the L4962 can be reduced by soldering the GND pins to a suitable copper area of the printed circuit board (Fig. 32).

The diagram of figure 33 shows the  $R_{th-j-amb}$  as a function of the side "l" of two equal square copper areas having the thickness of  $35\mu$  (1.4 mils). During

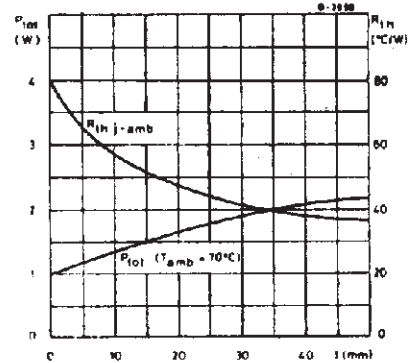
soldering the pins temperature must not exceed  $260^{\circ}\text{C}$  and the soldering time must not be longer than 12 seconds.

The external heatsink or printed circuit copper are must be connected to electrical ground.

**Figure 32. Example of P.C. board copper area which is used as heatsink**

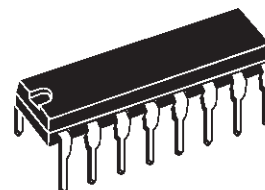


**Figure 33. Maximum dissippable power and junction to ambient thermal resistance vs. side "l"**

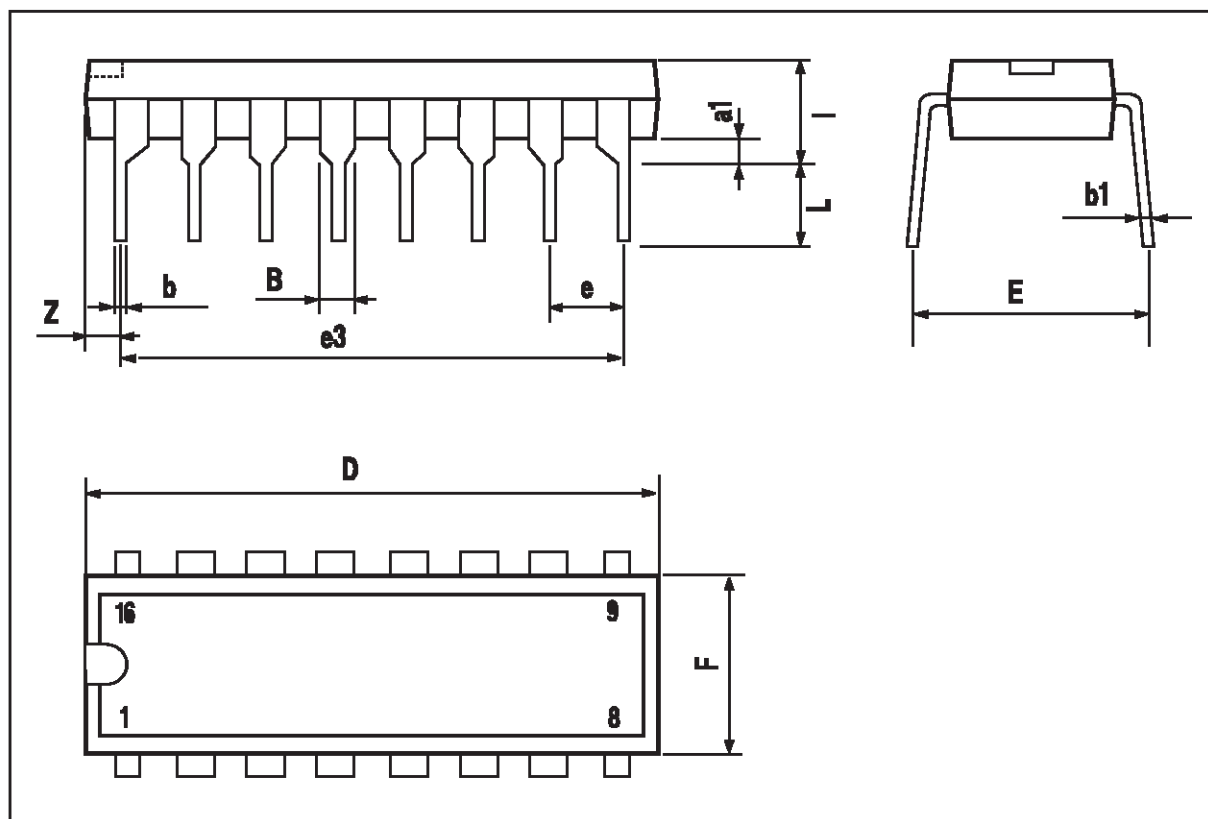


DIM.	mm			inch		
	MIN.	TYP.	MAX.	MIN.	TYP.	MAX.
a1	0.51			0.020		
B	0.85		1.40	0.033		0.055
b		0.50			0.020	
b1	0.38		0.50	0.015		0.020
D			20.0			0.787
E		8.80			0.346	
e		2.54			0.100	
e3		17.78			0.700	
F			7.10			0.280
I			5.10			0.201
L		3.30			0.130	
Z			1.27			0.050

## OUTLINE AND MECHANICAL DATA

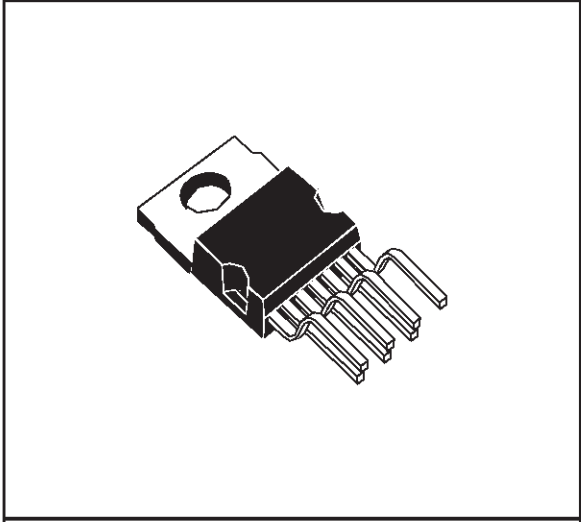


**Powerdip 16**

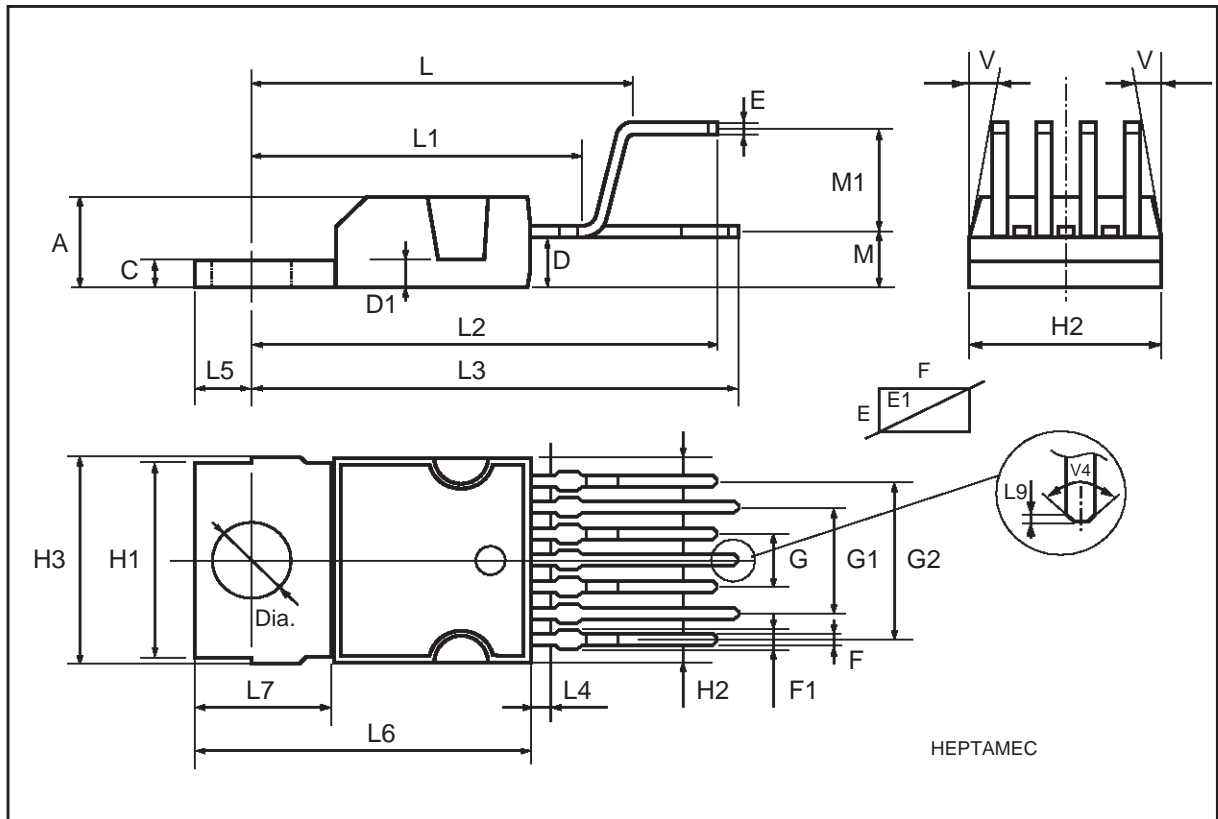


DIM.	mm			inch		
	MIN.	TYP.	MAX.	MIN.	TYP.	MAX.
A			4.8			0.189
C			1.37			0.054
D	2.4		2.8	0.094		0.110
D1	1.2		1.35	0.047		0.053
E	0.35		0.55	0.014		0.022
E1	0.7		0.97	0.028		0.038
F	0.6		0.8	0.024		0.031
F1			0.9			0.035
G	2.34	2.54	2.74	0.095	0.100	0.105
G1	4.88	5.08	5.28	0.193	0.200	0.205
G2	7.42	7.62	7.82	0.295	0.300	0.307
H2			10.4			0.409
H3	10.05		10.4	0.396		0.409
L	16.7	16.9	17.1	0.657	0.668	0.673
L1		14.92			0.587	
L2	21.24	21.54	21.84	0.386	0.848	0.860
L3	22.27	22.52	22.77	0.877	0.891	0.896
L4			1.29			0.051
L5	2.6	2.8	3	0.102	0.110	0.118
L6	15.1	15.5	15.8	0.594	0.610	0.622
L7	6	6.35	6.6	0.236	0.250	0.260
L9		0.2			0.008	
M	2.55	2.8	3.05	0.100	0.110	0.120
M1	4.83	5.08	5.33	0.190	0.200	0.210
V4	40° (typ.)					
Dia	3.65		3.85	0.144		0.152

**OUTLINE AND MECHANICAL DATA**

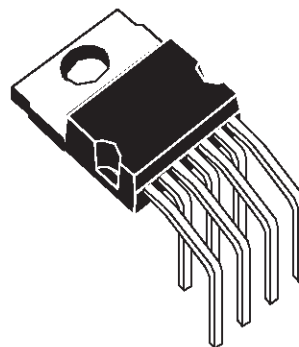


**Heptawatt V**

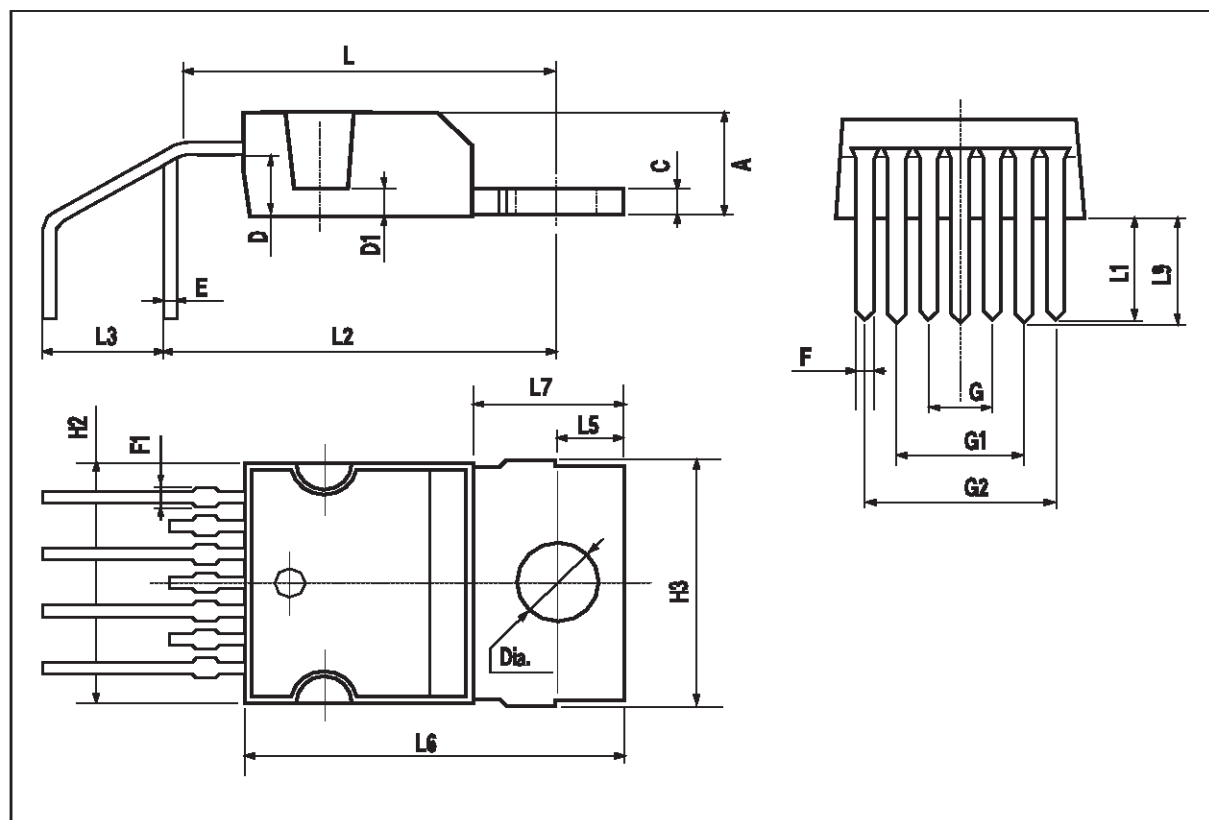


DIM.	mm			inch		
	MIN.	TYP.	MAX.	MIN.	TYP.	MAX.
A			4.8			0.189
C			1.37			0.054
D	2.4		2.8	0.094		0.110
D1	1.2		1.35	0.047		0.053
E	0.35		0.55	0.014		0.022
F	0.6		0.8	0.024		0.031
F1			0.9			0.035
G	2.41	2.54	2.67	0.095	0.100	0.105
G1	4.91	5.08	5.21	0.193	0.200	0.205
G2	7.49	7.62	7.8	0.295	0.300	0.307
H2			10.4			0.409
H3	10.05		10.4	0.396		0.409
L		14.2			0.559	
L1		4.4			0.173	
L2		15.8			0.622	
L3		5.1			0.201	
L5	2.6		3	0.102		0.118
L6	15.1		15.8	0.594		0.622
L7	6		6.6	0.236		0.260
L9		4.44			0.175	
Dia	3.65		3.85	0.144		0.152

## OUTLINE AND MECHANICAL DATA



### Heptawatt H



Information furnished is believed to be accurate and reliable. However, STMicroelectronics assumes no responsibility for the consequences of use of such information nor for any infringement of patents or other rights of third parties which may result from its use. No license is granted by implication or otherwise under any patent or patent rights of STMicroelectronics. Specification mentioned in this publication are subject to change without notice. This publication supersedes and replaces all information previously supplied. STMicroelectronics products are not authorized for use as critical components in life support devices or systems without express written approval of STMicroelectronics.

The ST logo is a registered trademark of STMicroelectronics

© 2000 STMicroelectronics – Printed in Italy – All Rights Reserved

STMicroelectronics GROUP OF COMPANIES

Australia - Brazil - China - Finland - France - Germany - Hong Kong - India - Italy - Japan - Malaysia - Malta - Morocco -  
Singapore - Spain - Sweden - Switzerland - United Kingdom - U.S.A.

<http://www.st.com>



This datasheet has been downloaded from:

[www.DatasheetCatalog.com](http://www.DatasheetCatalog.com)

Datasheets for electronic components.