

Silicon Diffused Power Transistor

BU2525DX

GENERAL DESCRIPTION

New generation, high-voltage, high-speed switching npn transistor with integrated damper diode in a plastic full-pack envelope intended for use in horizontal deflection circuits of large screen colour television receivers up to 32 kHz.

QUICK REFERENCE DATA

SYMBOL	PARAMETER	CONDITIONS	TYP.	MAX.	UNIT
V_{CESM}	Collector-emitter voltage peak value	$V_{BE} = 0$ V	-	1500	V
I_C	Collector current (DC)		-	12	A
I_{CM}	Collector current peak value		-	30	A
P_{tot}	Total power dissipation	$T_{hs} \leq 25$ °C	-	45	W
V_{CESat}	Collector-emitter saturation voltage	$I_C = 8.0$ A; $I_B = 1.6$ A	-	5.0	V
V_{CEO}	Collector-emitter voltage (open base)		-	800	V
I_{Csat}	Collector saturation current		8.0	-	A
t_s	Storage time	$I_{Csat} = 8.0$ A; $I_{B(end)} = 1.1$ A	3.0	4.0	μ s

PINNING - SOT399

PIN CONFIGURATION

SYMBOL

PIN	DESCRIPTION
1	base
2	collector
3	emitter
case	isolated

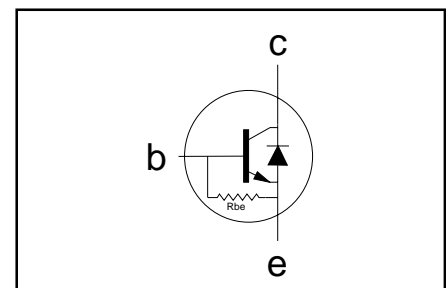
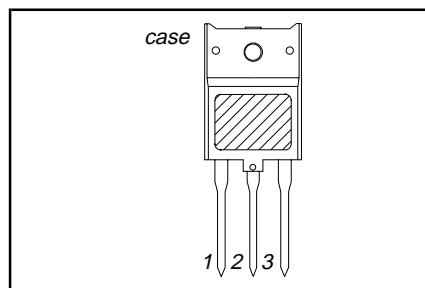

LIMITING VALUES

Limiting values in accordance with the Absolute Maximum Rating System (IEC 134)

SYMBOL	PARAMETER	CONDITIONS	MIN.	MAX.	UNIT
V_{CESM}	Collector-emitter voltage peak value	$V_{BE} = 0$ V	-	1500	V
V_{CEO}	Collector-emitter voltage (open base)		-	800	V
I_C	Collector current (DC)		-	12	A
I_{CM}	Collector current peak value		-	30	A
I_B	Base current (DC)		-	8	A
I_{BM}	Base current peak value		-	12	A
$-I_{B(AV)}$	Reverse base current	average over any 20 ms period	-	200	mA
$-I_{BM}$	Reverse base current peak value ¹		-	9	A
P_{tot}	Total power dissipation	$T_{hs} \leq 25$ °C	-	45	W
T_{stg}	Storage temperature		-55	150	°C
T_j	Junction temperature		-	150	°C

THERMAL RESISTANCES

SYMBOL	PARAMETER	CONDITIONS	TYP.	MAX.	UNIT
$R_{th j-hs}$	Junction to heatsink	without heatsink compound	-	3.7	K/W
$R_{th j-hs}$	Junction to heatsink	with heatsink compound	-	2.8	K/W
$R_{th j-a}$	Junction to ambient	in free air	35	-	K/W

¹ Turn-off current.

Silicon Diffused Power Transistor

BU2525DX

ISOLATION LIMITING VALUE & CHARACTERISTIC

 $T_{hs} = 25\text{ }^{\circ}\text{C}$ unless otherwise specified

SYMBOL	PARAMETER	CONDITIONS	MIN.	TYP.	MAX.	UNIT
V_{isol}	Repetitive peak voltage from all three terminals to external heatsink	R.H. $\leq 65\%$; clean and dustfree	-		2500	V
C_{isol}	Capacitance from T2 to external heatsink	$f = 1\text{ MHz}$	-	22	-	pF

STATIC CHARACTERISTICS

 $T_{hs} = 25\text{ }^{\circ}\text{C}$ unless otherwise specified

SYMBOL	PARAMETER	CONDITIONS	MIN.	TYP.	MAX.	UNIT
I_{CES}	Collector cut-off current ²	$V_{BE} = 0\text{ V}; V_{CE} = V_{CESMmax}$	-	-	1.0	mA
I_{CES}		$V_{BE} = 0\text{ V}; V_{CE} = V_{CESMmax}$ $T_j = 125\text{ }^{\circ}\text{C}$	-	-	2.0	mA
I_{EBO}	Emitter cut-off current	$V_{EB} = 6.0\text{ V}; I_C = 0\text{ A}$	72	110	218	mA
R_{EB}	Base-emitter resistance	$V_{EB} = 6.0\text{ V}$	-	55	-	Ω
BV_{EBO}	Emitter-base breakdown voltage	$I_B = 600\text{ mA}$	7.5	13.5	-	V
$V_{CEOsust}$	Collector emitter sustaining voltage	$I_B = 0\text{ A}; I_C = 100\text{ mA};$ $L = 25\text{ mH}$	800	-	-	V
V_{CEsat}	Collector-emitter saturation voltage	$I_C = 8.0\text{ A}; I_B = 1.6\text{ A}$	-	-	5.0	V
V_{BEsat}	Base-emitter saturation voltage	$I_C = 8.0\text{ A}; I_B = 1.6\text{ A}$	-	-	1.1	V
h_{FE}	DC current gain	$I_C = 1\text{ A}; V_{CE} = 5\text{ V}$	-	11	-	
h_{FE}		$I_C = 8\text{ A}; V_{CE} = 5\text{ V}$	5	7	9.5	
V_F	Diode forward voltage	$I_F = 8\text{ A}$	-	1.6	2.0	V

DYNAMIC CHARACTERISTICS

 $T_{hs} = 25\text{ }^{\circ}\text{C}$ unless otherwise specified

SYMBOL	PARAMETER	CONDITIONS	TYP.	MAX.	UNIT
C_c	Collector capacitance	$I_E = 0\text{ A}; V_{CB} = 10\text{ V}; f = 1\text{ MHz}$	145	-	pF
	Switching times (32 kHz line deflection circuit)	$I_{Csat} = 8.0\text{ A}; L_C = 260\text{ }\mu\text{H}; C_{fb} = 13\text{ nF};$ $I_{B(end)} = 1.1\text{ A}; L_B = 2.5\text{ }\mu\text{H}; -V_{BB} = 4\text{ V};$ $(-di_B/dt = 1.6\text{ A}/\mu\text{s})$			
t_s	Turn-off storage time		3.0	4.0	μs
t_f	Turn-off fall time		0.2	0.35	μs
V_{fr}	Anti-parallel diode forward recovery voltage	$I_F = 8\text{ A}; di_F/dt = 50\text{ A}/\mu\text{s}$	16	-	V
t_{fr}	Anti-parallel diode forward recovery time	$V_F = 5\text{ V}$	410	-	ns

² Measured with half sine-wave voltage (curve tracer).

Silicon Diffused Power Transistor

BU2525DX

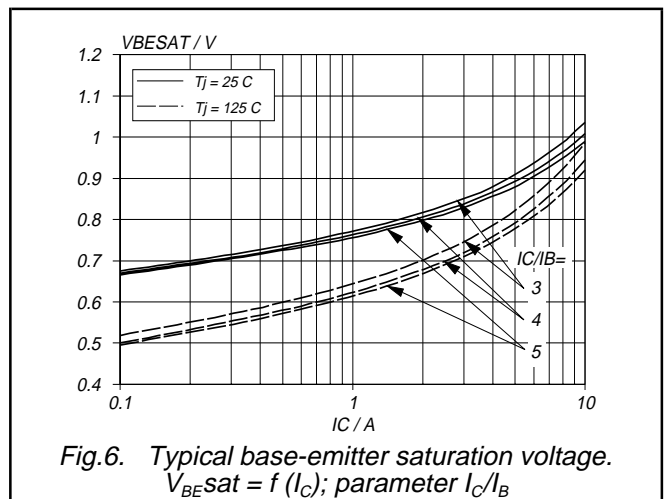
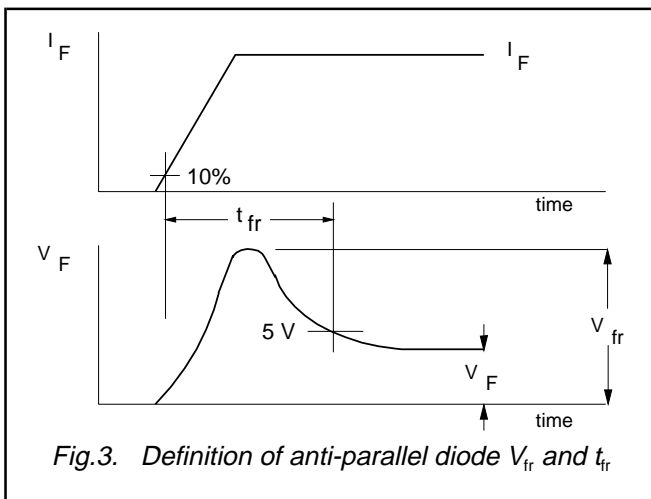
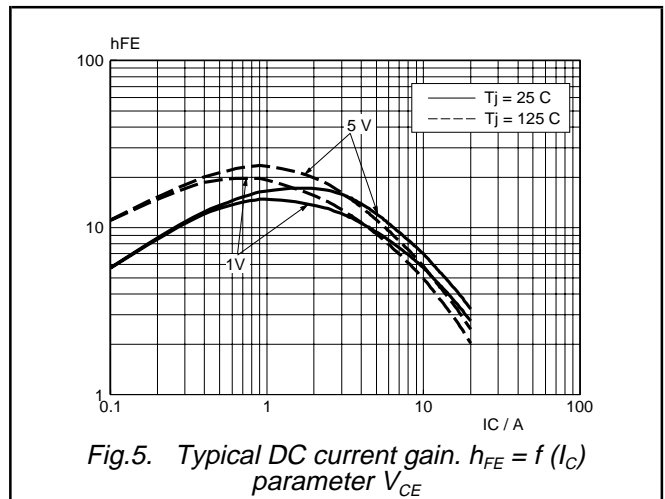
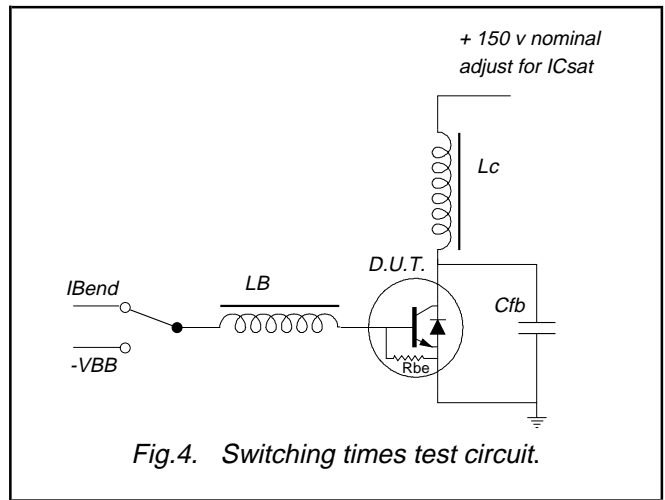
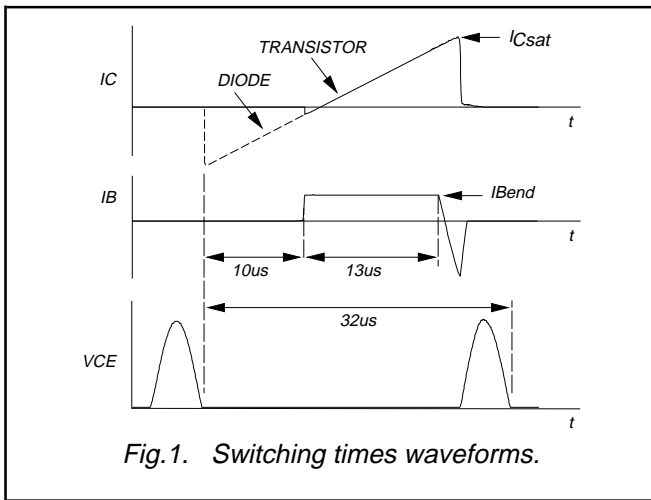

Silicon Diffused Power Transistor

BU2525DX

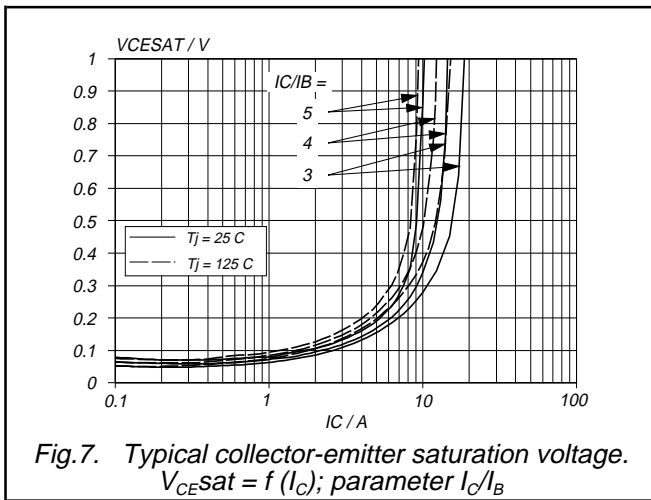

Fig. 7. Typical collector-emitter saturation voltage. $V_{CESAT} = f(I_C)$; parameter I_C/I_B

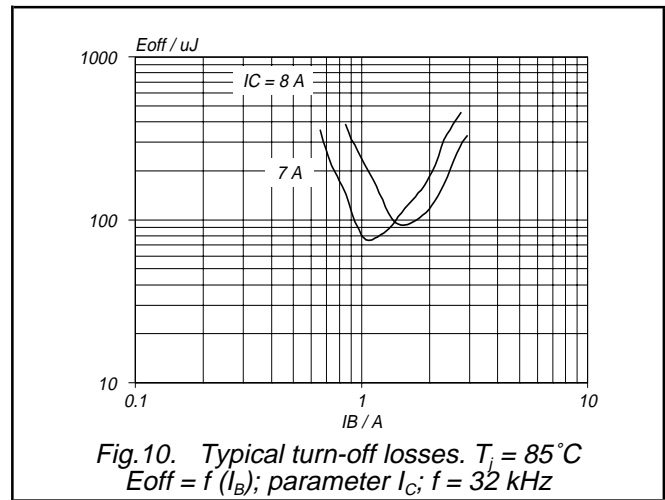

Fig. 10. Typical turn-off losses. $T_J = 85\text{ C}$ $E_{off} = f(I_B)$; parameter I_C ; $f = 32\text{ kHz}$

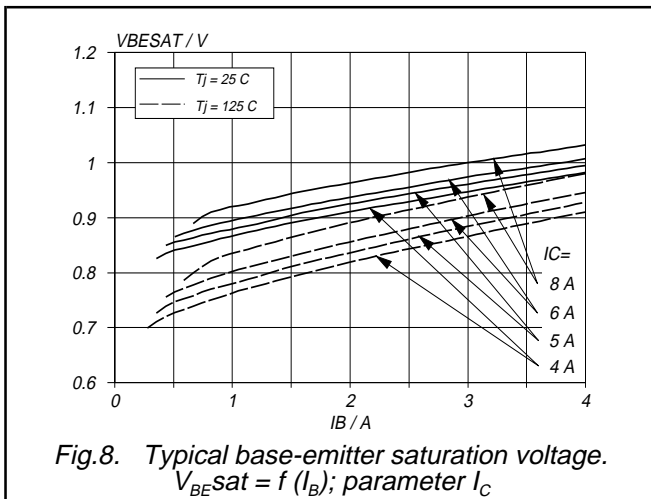

Fig. 8. Typical base-emitter saturation voltage. $V_{BEsat} = f(I_B)$; parameter I_C

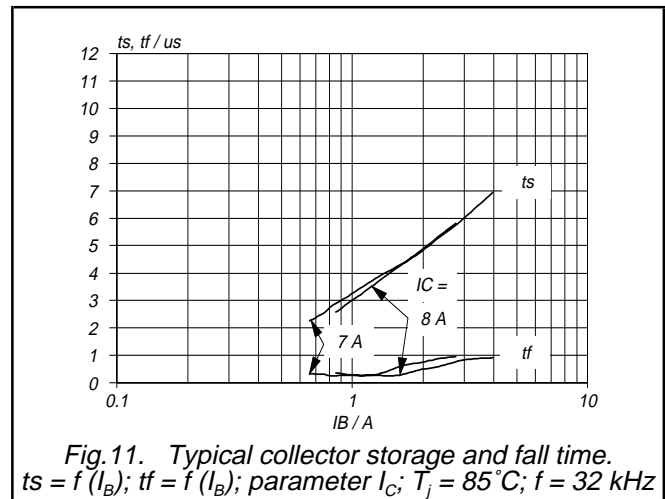

Fig. 11. Typical collector storage and fall time. $t_s = f(I_B)$; $t_f = f(I_B)$; parameter I_C ; $T_J = 85\text{ C}$; $f = 32\text{ kHz}$

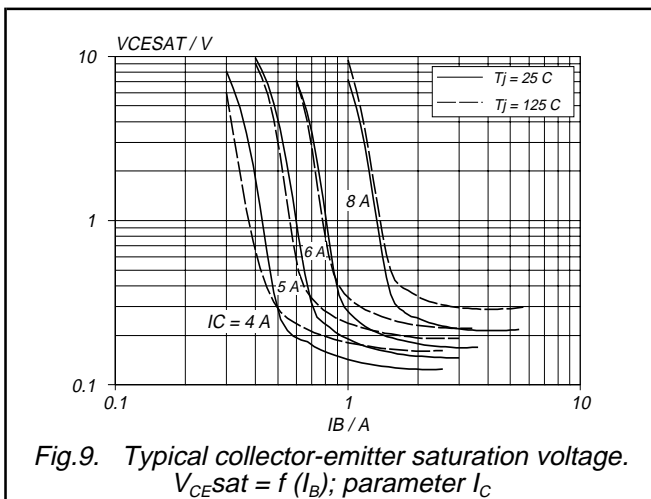

Fig. 9. Typical collector-emitter saturation voltage. $V_{CESAT} = f(I_B)$; parameter I_C

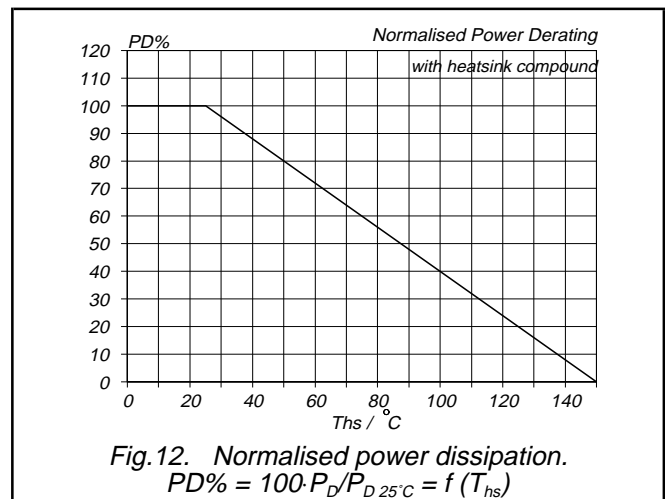
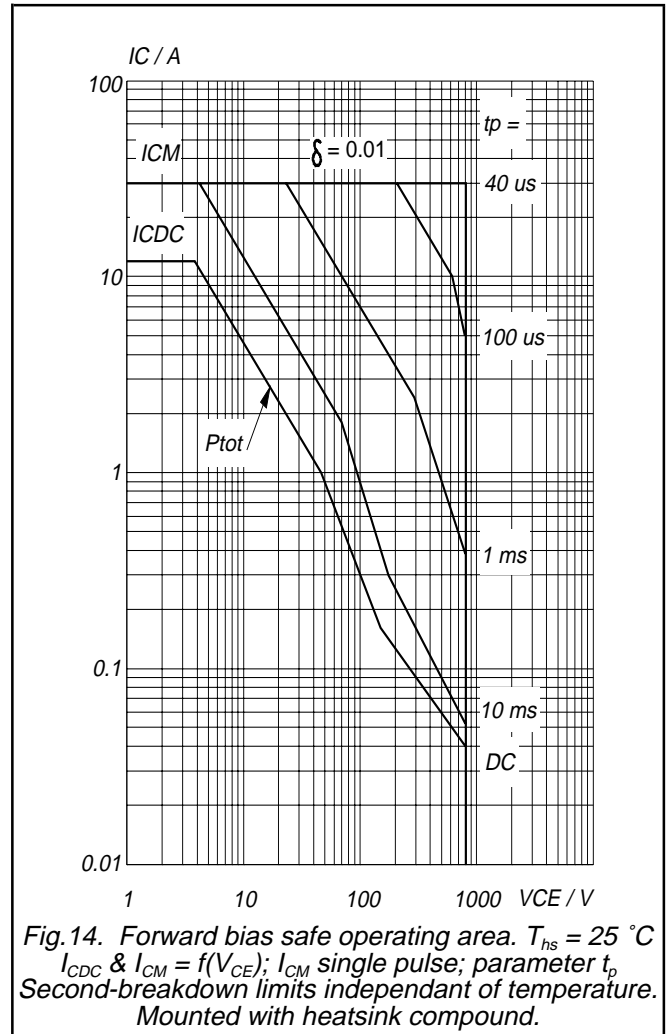
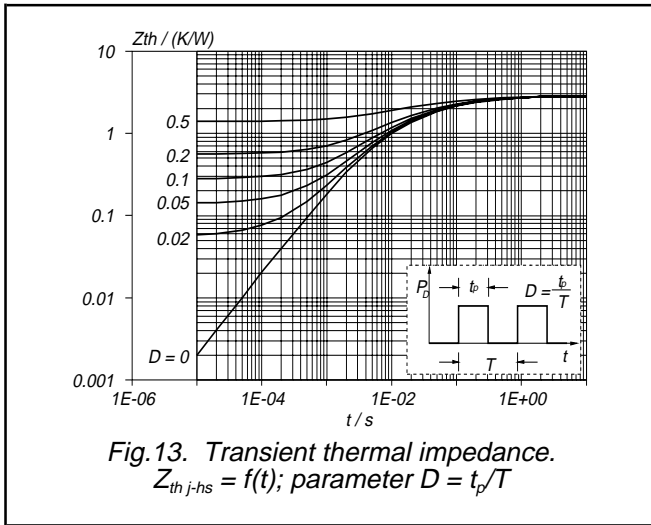

Fig. 12. Normalised power dissipation. $PD\% = 100 \cdot P_D / P_{D25\text{ C}} = f(T_{hs})$

Silicon Diffused Power Transistor

BU2525DX



Silicon Diffused Power Transistor

BU2525DX

MECHANICAL DATA

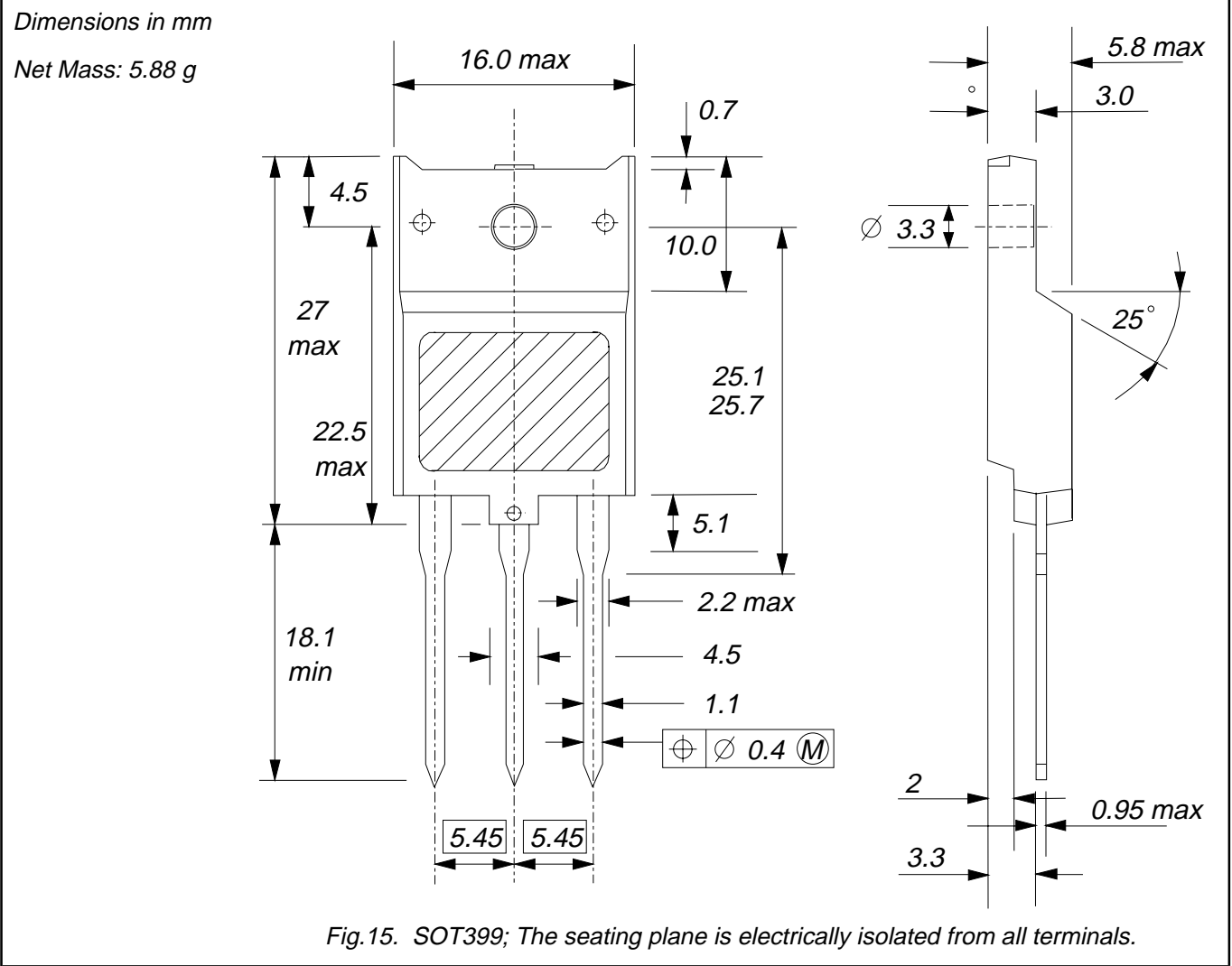

Notes

- 1. Refer to mounting instructions for F-pack envelopes.
- 2. Epoxy meets UL94 V0 at 1/8".

Silicon Diffused Power Transistor

BU2525DX

DEFINITIONS

Data sheet status	
Objective specification	This data sheet contains target or goal specifications for product development.
Preliminary specification	This data sheet contains preliminary data; supplementary data may be published later.
Product specification	This data sheet contains final product specifications.
Limiting values	
Limiting values are given in accordance with the Absolute Maximum Rating System (IEC 134). Stress above one or more of the limiting values may cause permanent damage to the device. These are stress ratings only and operation of the device at these or at any other conditions above those given in the Characteristics sections of this specification is not implied. Exposure to limiting values for extended periods may affect device reliability.	
Application information	
Where application information is given, it is advisory and does not form part of the specification.	
© Philips Electronics N.V. 1997	
All rights are reserved. Reproduction in whole or in part is prohibited without the prior written consent of the copyright owner.	
The information presented in this document does not form part of any quotation or contract, it is believed to be accurate and reliable and may be changed without notice. No liability will be accepted by the publisher for any consequence of its use. Publication thereof does not convey nor imply any license under patent or other industrial or intellectual property rights.	

LIFE SUPPORT APPLICATIONS

These products are not designed for use in life support appliances, devices or systems where malfunction of these products can be reasonably expected to result in personal injury. Philips customers using or selling these products for use in such applications do so at their own risk and agree to fully indemnify Philips for any damages resulting from such improper use or sale.

This datasheet has been download from:

www.datasheetcatalog.com

Datasheets for electronics components.