

AN5707NS

TV Electronic Tuner-Control IC

Overview

The AN5707NS is an integrated circuit for tuner-control circuit of auto-search-tuning system.

Features

- Low supply-voltage operation ($V_{CC}=4.2$ to $5.5V$)
- Low power consumption by Bi-CMOS Process (30mW typ.)
- Auto search by Up-Down Switch
- Bar display on the screen (tuning channel)

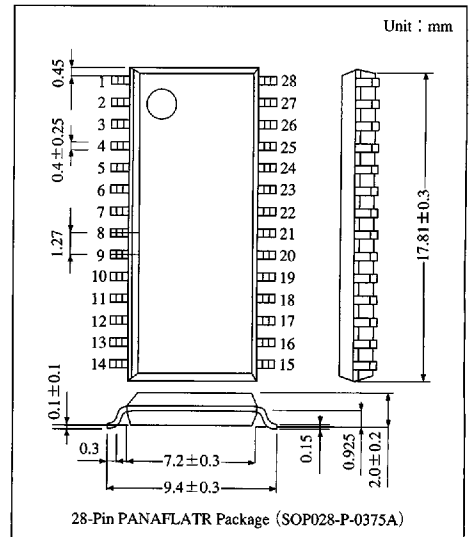

Block Diagram

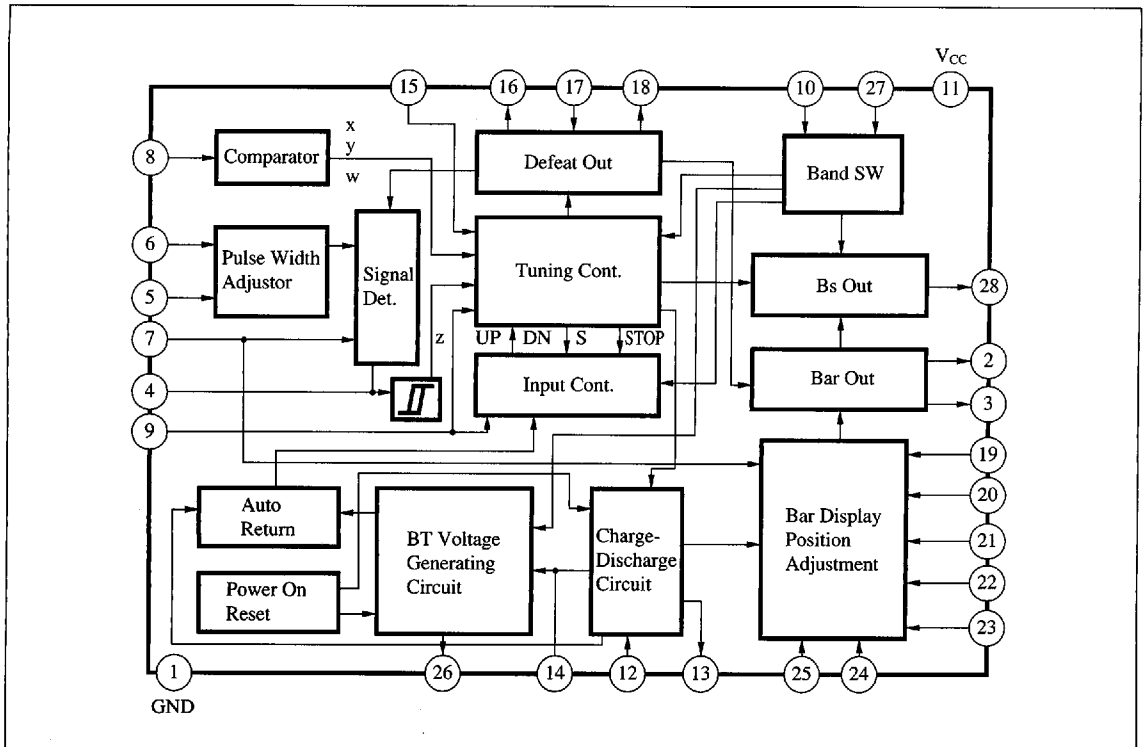

6932852 0014395 92T

■ Absolute Maximum Ratings (Ta=25°C)

Parameter	Symbol	Rating	Unit
Supply voltage	V _{CC}	6	V
Pin voltage	V ₂₈₋₁	10	V
Supply current	I _{CC}	12	mA
Pin current	I ₂	-1 to 0	mA
	I ₃	-1 to 0	
	I ₂₆	-0.2 to +0.2	
	I ₂₈	0 to +2	
Power dissipation	P _D	72	mW
Operating ambient temperature	T _{opr}	-20 to +70	°C
Storage temperature	T _{stg}	-40 to +125	°C

■ Recommended Operating Range (Ta=25°C)

Parameter	Symbol	Range
Operating supply voltage range	V _{CC}	4.2V to 5.5V

■ Electrical Characteristics (Ta=25°C)

Parameter	Symbol	Condition				Unit
			min	typ	max	
Circuit current	I ₁₁	V _{CC} =5V	4	6	8.5	mA
Pin voltage	V ₉₋₁	V _{CC} =5V	2.2	2.5	2.8	V
Flyback pulse input threshold voltage	V _{TH6}	V _{CC} =5V	1	1.5	2.4	V
Horizontal synchronous signal input threshold voltage	V _{TH7}	V _{CC} =5V	2.6	3.1	3.6	V
BS output voltage "H"	V _{28-1(H)}		9.1	9.5	—	V
BS output voltage "L"	V _{28-1(L)}	I ₂₈ =1mA	—	0.1	0.4	V
Tuning control (1)	V _{16-1(H)}	Except the case during reception (S=0)	3.9	4.2	4.6	V
Tuning control (2)	V _{16-1(L)}	During reception (S=1)	-0.2	0	0.2	V
Charging/discharging current (1)	I _{CHA(1)}	V ₁₃₋₁ =2.5V, during VHF search-up	-47	—	-20	μA
Charging/discharging current (2)	I _{CHA(2)}	V ₁₃₋₁ =2.5V, during VHF search-down	8	—	17.5	μA
Charging/discharging current (3)	I _{CHA(3)}	V ₁₃₋₁ =2.5V, during VHF tuning preparation (+)	-14	—	-5	μA
Charging/discharging current (4)	I _{CHA(4)}	V ₁₃₋₁ =2.5V, during VHF tuning preparation (-)	3.2	—	7.8	μA
Charging/discharging current (5)	I _{CHA(5)}	V ₁₃₋₁ =2.5V, during UHF search-up	-21.5	—	-9.5	μA
Charging/discharging current (6)	I _{CHA(6)}	V ₁₃₋₁ =2.5V, during UHF search-down	4.8	—	10.5	μA
Charging/discharging current (7)	I _{CHA(7)}	V ₁₃₋₁ =2.5V, during UHF tuning preparation (+)	-4	—	-1.6	μA
Charging/discharging current (8)	I _{CHA(8)}	V ₁₃₋₁ =2.5V, during UHF tuning preparation (-)	1.4	—	3.8	μA
Channel call input threshold voltage	V _{TH17}	V _{CC} =5V	1.9	2.4	2.9	V
Output saturation voltage	V _{CE(sat)} (Pin⑧)	I ₁₈ =300 μA	—	0.1	0.4	V
BT amp. characteristics VHFL (1)	V ₂₆₋₁₍₁₎	V ₁₄₋₁ =1.5V	-0.2	0	0.2	V
BT amp. characteristics VHFL (2)	V ₂₆₋₁₍₂₎	V ₁₄₋₁ =3.5V	3.9	4.25	4.6	V
BT amp. inclination (1) VHF _L	ΔV ₂₆₋₁₍₁₎	V ₁₄₋₁ =2.8-2.2V	2.1	2.45	2.8	V
BT amp. characteristics (1) UHF	V ₂₆₋₁₍₃₎	V ₁₄₋₁ =2V	-0.2	0	0.2	V
BT amp. characteristics (2) UHF	V ₂₆₋₁₍₄₎	V ₁₄₋₁ =5V	4	4.3	4.6	V
BT amp. inclination (2) UHF	ΔV ₂₆₋₁₍₂₎	V ₁₄₋₁ =3.4-2.8V	0.5	0.85	1.2	V
BT amp. inclination (3)	ΔV ₂₆₋₁₍₂₎	V ₁₄₋₁ =4.4-4V	0.7	1.1	1.5	V

ICs for TV

6932852 0014396 866

Panasonic

■ Electrical Characteristics (cont.) (Ta=25°C)

Parameter	Symbol	Condition	min	typ	max	Unit
Bar display output pulse width (VHF _H)	τ_{VHFH}	V _{CC} =5V	1	1.4	1.8	μ S
Bar display output pulse width (UHF)	τ_{UHF}	V _{CC} =5V	1	1.4	1.8	μ S
Bar display output pulse peak value (VHF _H)	V _{VHFH}	V _{CC} =5V	2.7	3	—	V _{PP}
Bar display output pulse peak value (UHF)	V _{UHF}	V _{CC} =5V	2.7	3	—	V _{PP}
Auto return lower limit threshold voltage	V _{LL}	V _{CC} =5V	0.12	0.22	0.3	V
Auto return upper limit threshold voltage	V _{HL}	V _{CC} =5V	4.25	4.45	4.65	V

■ Application Circuit

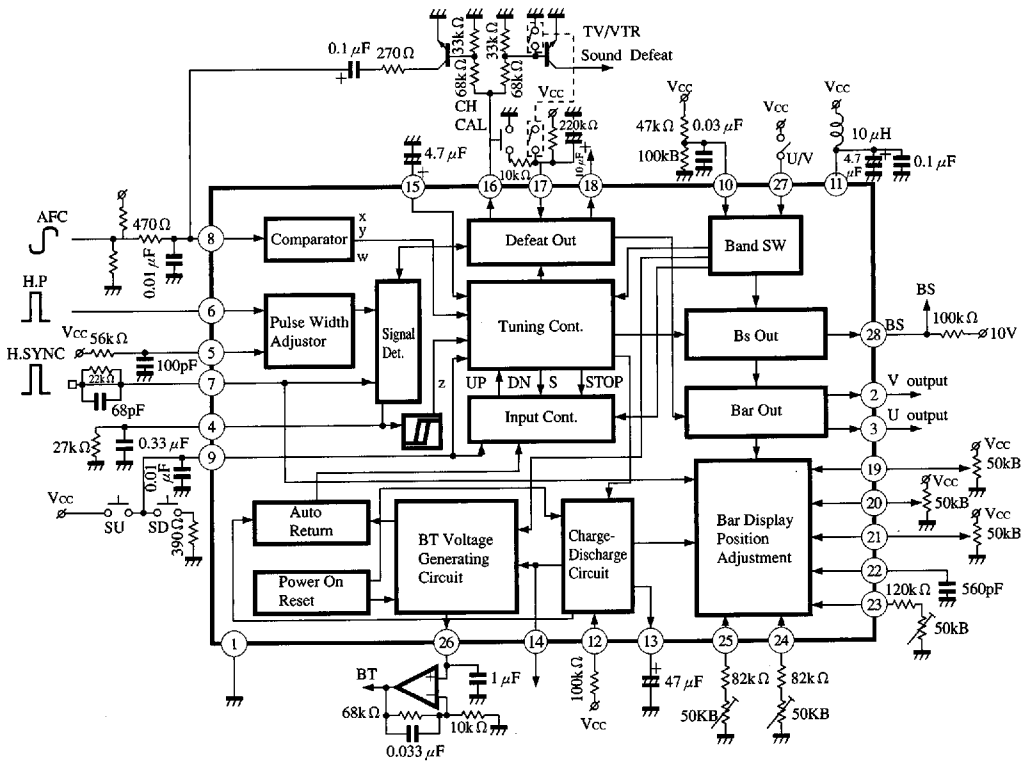

■ 6932852 0014397 7T2 ■









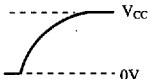

Panasonic

Pin Descriptions

Pin No.	Pin name	Typ. waveform	Description	I/O impedance	Equivalent circuit
1	GND		GND pin.	—	
2	Bar display output (VHF)		Outputs a pulse of positive polarity for bar display at the time of VHF reception.	500 Ω	
3	Bar display output (UHF)		Outputs a pulse of positive polarity for bar display at the time of UHF reception.	500 Ω	
4	Signal detection		Determines the presence/absence of a TV signal by the DC voltage of this pin. Connect the CR filter externally.	High impedance	
5	H.P. waveform shaping mono/multi		Filter pin for H.P. pulse-waveform shaping circuit. The output pulse width is changed by the CR of time constant.	High impedance	
6	Flyback pulse input		Input a horizontal flyback pulse (positive polarity) to detect a signal.	56k Ω	
7	Horizontal signal input		Input a horizontal synchronous separation signal (positive polarity) to detect a signal.	68k Ω	
8	AFC input		Filter the AFC signal for input, which is significant for search tuning.	< 1M Ω	
9	Search-up/-down input		Search-up is started when this pin is set to V _{CC} and search-down is started when it is set to GND.	100k Ω	
10	Lch/hch switching voltage input		Lch/Hch switching point setting pin. Lch/Hch of VHF is automatically switched.	100k Ω	
11	Supply voltage		Supply current is 6mA and the operating supply voltage range is 4.2 to 5.5V. V _{CC} should be regulated before use.	—	
12	Search speed adjustment		The search speed is varied with constant-current to be input to this pin.	7k Ω	

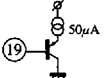
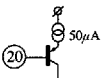
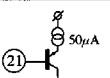
ICs for TV

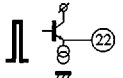
■ Pin Descriptions (cont.)

Pin No.	Pin name	Typ. waveform	Description	I/O impedance	Equivalent circuit
13	Charging capacitor connection	—	Pin for generating MANU (14) voltage in auto search. Insert the capacitor of about $47\mu\text{F}$ with great care of leak.	High impedance	
14	BT voltage generation (Manual)	—	Pin for generating BT voltage (25) in manual search. Should be opened in auto search.	$> 1\text{k}\Omega$	
15	Temporary stop capacitor connection		Insert the capacitor of about $4.7\mu\text{F}$ between this pin and GND in order to stop temporarily at the tuned channel during auto search.	$100\text{k}\Omega$	
16	Defeat output	—	Used for switching of audio defeat, and of time constant of AFC filter, etc. Search : H, Tuning : OPEN	—	
17	Channel call	—	A channel display bar appears when this pin is set to GND and does not appear when it is set to V_{CC} .	$10\text{k}\Omega$	
18	Bright output	—	Pin for darkening the screen when a channel display bar appears, and this pin is connected to the brightness volume. Search : 0V, Tuning : OPEN	—	
19	Bar display position adjustment (1)	—	Pin for adjusting the position of a channel-display-bar at the time of VHF reception. The position of a channel-display-bar is varied with the DC voltage to be given to this pin.	$< 100\text{k}\Omega$	
20	Bar display position adjustment (2)	—	Pin for adjusting the position of a channel-display-bar at the time of VHF Lch reception. The position of a channel-display-bar is varied with the DC voltage to be given to this pin.	$< 100\text{k}\Omega$	
21	Bar display position adjustment (3)	—	Pin for adjusting the position of a channel-display-bar at the time of VHF Hch reception. The position of a channel-display-bar is varied with the DC voltage to be given to this pin.	$< 100\text{k}\Omega$	
22	Filter		To generate a sawtooth wave for determining the position of a channel-display-bar. Insert the capacitor of about 560pF between this pin and GND.	—	
23	Bar display position adjustment (4)	—	Pin for determining the amplitude, on the panel, of a channel-display-bar at the time of VHF reception (the position of a display bar on the panel when the highest channel is received). The amplitude is varied with the quantity of current flowing out of this pin.	—	

Pin Descriptions (cont.)

Pin No.	Pin name	Typ. waveform	Description	I/O impedance	Equivalent circuit										
24	Bar display position adjustment (5)	—	Pin for determining the amplitude, on the panel, of a channel-display-bar at the time of VHF Hch reception (the position of a display bar on the panel when the highest channel is received). The amplitude is varied with the quantity of current flowing out of this pin.	—											
25	Bar display position adjustment (6)	—	Pin for determining the amplitude, on the panel, of a channel-display-bar at the time of VHF Lch reception (the position of a display bar on the panel when the highest channel is received). The amplitude is varied with the quantity of current flowing out of this pin.	—											
26	BT voltage generation	—	Pin for outputting BT-voltage for tuner. Compensation of tuner-characteristics is applied.	12kΩ											
27	U/V switching	—	UHF/VHF switching pin. V _{CC}VHF GND or OPEN.....UHF	24kΩ											
28	BS output	—	Tuner BS output pin, which is opened-collector output. Used at 10V or less. <table border="1" style="margin: 5px auto;"> <thead> <tr> <th rowspan="2">Band</th> <th colspan="2">VHF</th> <th rowspan="2">UHF</th> </tr> <tr> <th>Lch :</th> <th>Hch :</th> </tr> </thead> <tbody> <tr> <td>BS</td> <td>OPEN</td> <td>0V</td> <td>0V</td> </tr> </tbody> </table>	Band	VHF		UHF	Lch :	Hch :	BS	OPEN	0V	0V	—	
Band	VHF		UHF												
	Lch :	Hch :													
BS	OPEN	0V	0V												

ICs for TV

Supplementary Explanation

Design Reference Value of Electrical Characteristics (T_a=25°C)

Parameter	Symbol	Condition	min	typ	max	Unit
AFC threshold voltage (1)	V _{AFC} (1)	V _{CC} =5V	—	3.75	4.1	V
AFC threshold voltage (2)	V _{AFC} (2)	V _{CC} =5V	—	3.1	—	V
AFC threshold voltage (3)	V _{AFC} (3)	V _{CC} =5V	2.6	2.9	—	V
Search-up threshold voltage	V _{TH9} (U)	V _{CC} =5V	—	3.5	4	V
Search-down threshold voltage	V _{TH9} (D)	V _{CC} =5V	1	1.5	—	V

Note) The value in the above characteristics is not a guaranteed value, but reference one on design.

Characteristic Curve

