



# STPS10L60CF/CFP

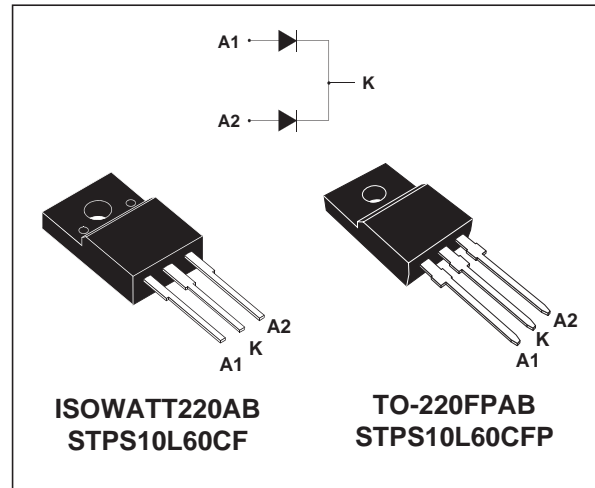
## POWER SCHOTTKY RECTIFIER

### MAIN PRODUCT CHARACTERISTICS

$I_{F(AV)}$	2 x 5 A
$V_{RRM}$	60 V
$T_j(\text{max})$	150 °C
$V_F(\text{max})$	0.52 V

### FEATURES AND BENEFITS

- LOW FORWARD VOLTAGE DROP
- NEGLIGIBLE SWITCHING LOSSES
- INSULATED PACKAGE:  
Insulating voltage = 2000V DC  
Capacitance = 12pF



### DESCRIPTION

Dual center tap Schottky rectifiers suited for Switched Mode Power Supplies and high frequency DC to DC converters.

Packaged in ISOWATT220AB, TO-220FPAB this device is intended for use in high frequency inverters.

### ABSOLUTE RATINGS (limiting values, per diode)

Symbol	Parameter			Value	Unit	
$V_{RRM}$	Repetitive peak reverse voltage			60	V	
$I_{F(RMS)}$	RMS forward current			30	A	
$I_{F(AV)}$	Average forward current	ISOWATT220AB TO220FPAB	$T_c = 130^\circ\text{C}$ $\delta = 0.5$	Per diode Per device	5 10	A
$I_{FSM}$	Surge non repetitive forward current		$t_p = 10 \text{ ms}$ Sinusoidal	180	A	
$I_{RRM}$	Repetitive peak reverse current		$t_p = 2 \mu\text{s}$ square F = 1kHz	1	A	
$T_{stg}$	Storage temperature range			- 65 to + 175	°C	
$T_j$	Maximum operating junction temperature *			150	°C	
dV/dt	Critical rate of rise reverse voltage			10000	V/ $\mu\text{s}$	

\* :  $\frac{dP_{tot}}{dT_j} < \frac{1}{R_{th(j-a)}}$  thermal runaway condition for a diode on its own heatsink

## STPS10L60CF/CFP

### THERMAL RESISTANCE

Symbol	Parameter	Value	Unit
$R_{th(j-c)}$	Junction to case ISOWATT220AB TO-220FPAB	Per Diode	4.5
		Total	3.5
$R_{th(c)}$	Coupling	2.5	$^{\circ}\text{C/W}$

When the diodes 1 and 2 are used simultaneously :  
 $\Delta T_{j(\text{diode } 1)} = P(\text{diode } 1) \times R_{th(j-c)}(\text{Per diode}) + P(\text{diode } 2) \times R_{th(c)}$

### STATIC ELECTRICAL CHARACTERISTICS (per diode)

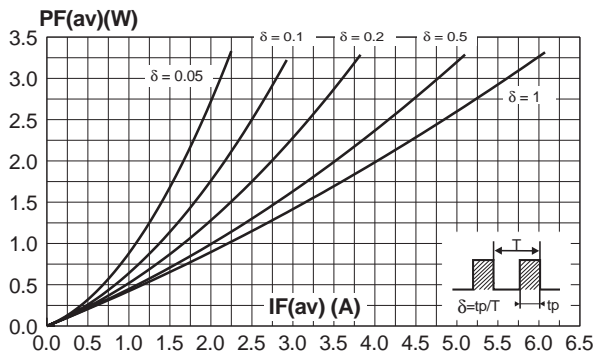
Symbol	Parameter	Tests conditions	Min.	Typ.	Max.	Unit			
$I_R^*$	Reverse leakage current	$T_j = 25^{\circ}\text{C}$	$V_R = V_{RRM}$		220	$\mu\text{A}$			
		$T_j = 125^{\circ}\text{C}$				45	60	mA	
$V_F^*$	Forward voltage drop	$T_j = 25^{\circ}\text{C}$	$I_F = 5 \text{ A}$		0.55	V			
		$T_j = 125^{\circ}\text{C}$					0.43	0.52	
		$T_j = 25^{\circ}\text{C}$					$I_F = 10 \text{ A}$		0.67
		$T_j = 125^{\circ}\text{C}$							

Pulse test : \*  $t_p = 380 \mu\text{s}$ ,  $\delta < 2\%$

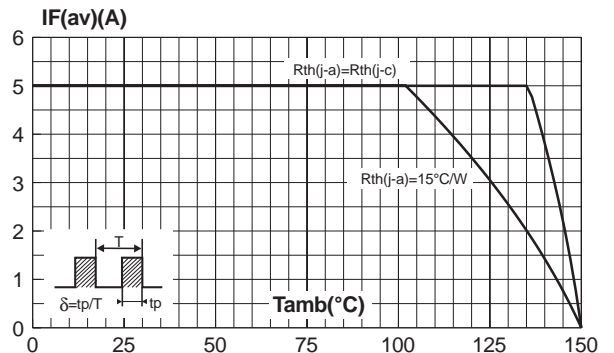
To evaluate the conduction losses use the following equation :

$$P = 0.4 \times I_{F(AV)} + 0.024 I_{F(RMS)}^2$$

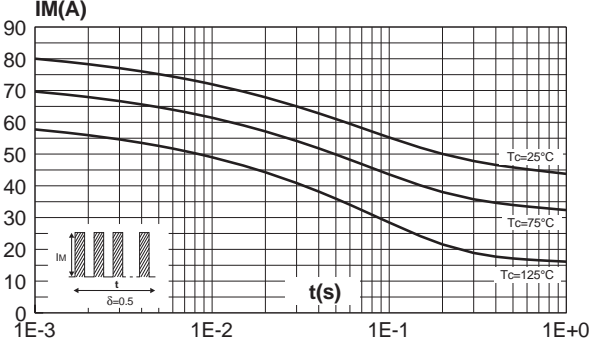
**Fig. 1:** Average forward power dissipation versus average forward current (per diode).



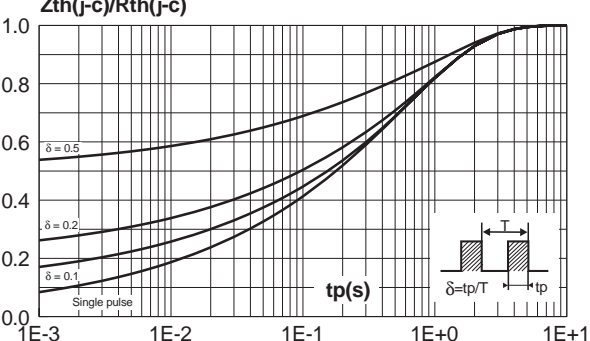
**Fig. 2:** Average current versus ambient temperature ( $\delta=0.5$ ) (per diode).



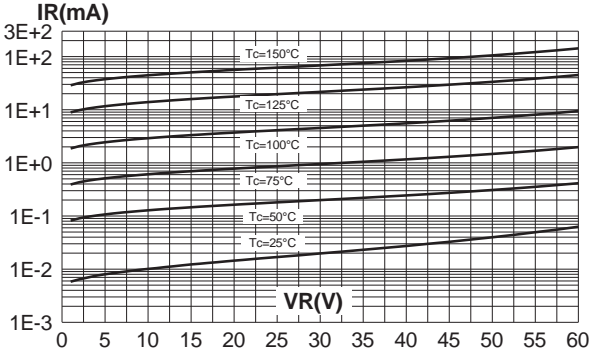
**Fig. 3:** Non repetitive surge peak forward current versus overload duration (maximum values, per diode). ISOWATT220AB, TO-220FPAB



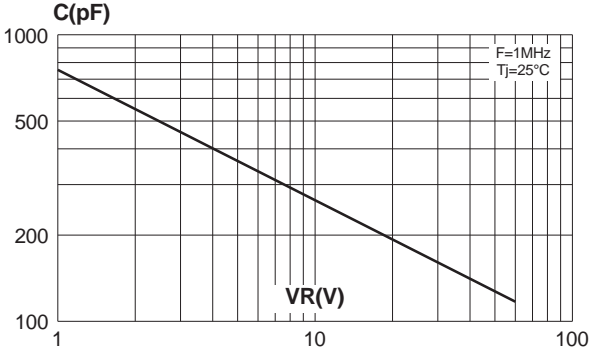
**Fig. 4:** Relative variation of thermal transient impedance junction to case versus pulse duration. ISOWATT220AB, TO-220FPAB



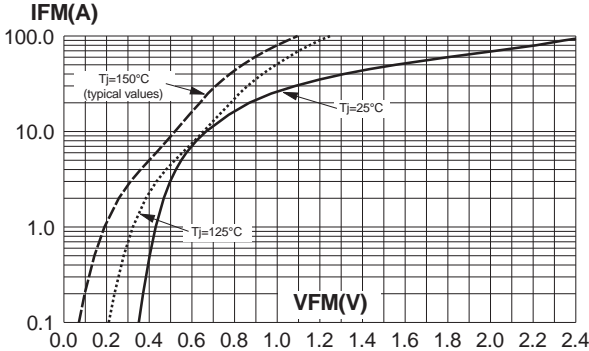
**Fig. 5:** Reverse leakage current versus reverse voltage applied (typical values, per diode).



**Fig. 6:** Junction capacitance versus reverse voltage applied (typical values, per diode).

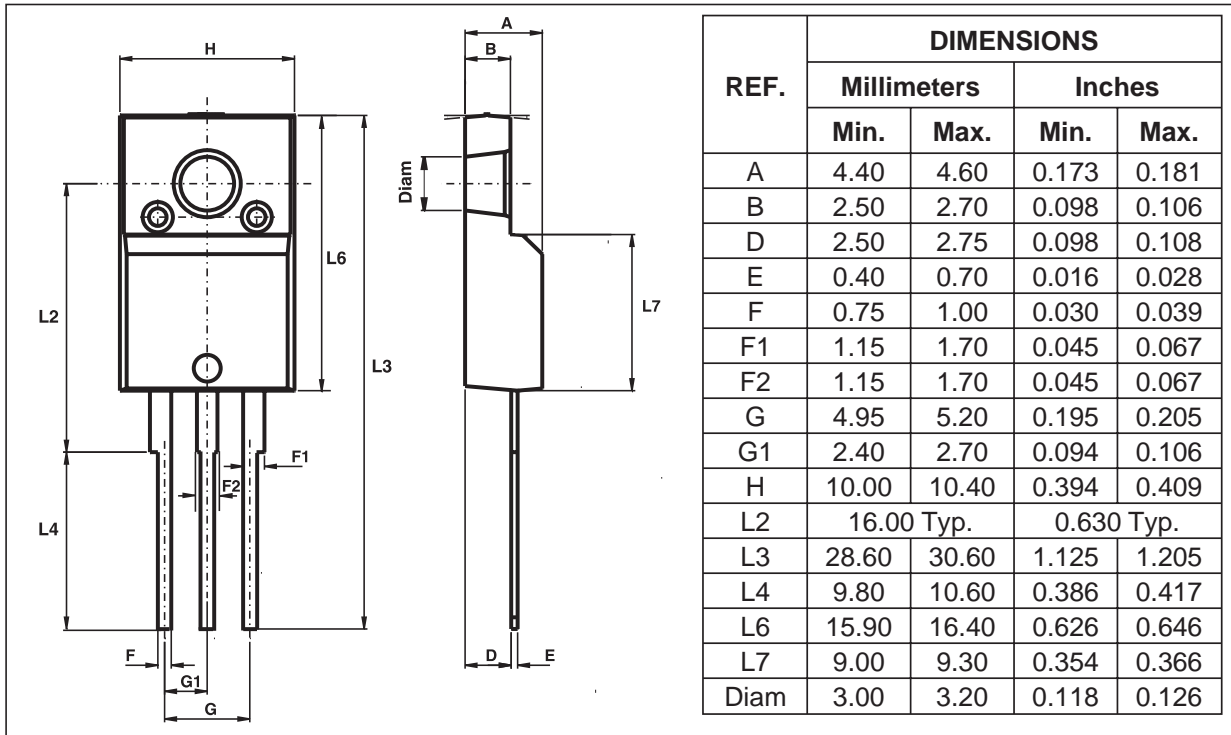


**Fig. 7:** Forward voltage drop versus forward current (maximum values, per diode).



**STPS10L60CF/CFP**

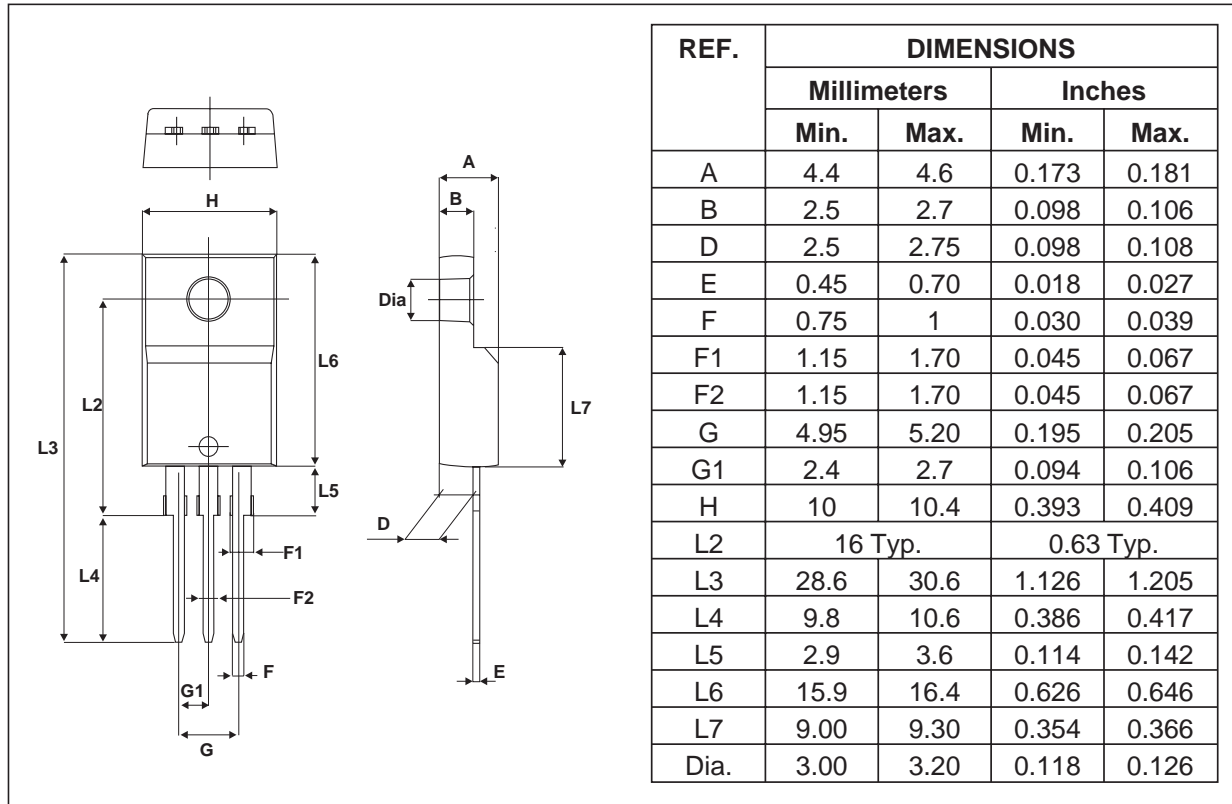
**PACKAGE MECHANICAL DATA**  
ISOWATT220AB



- Cooling method: C
- Recommended torque value: 0.55 m.N
- Maximum torque value: 0.70 m.N

**PACKAGE MECHANICAL DATA**

TO-220FPAB



Ordering type	Marking	Package	Weight	Base qty	Delivery mode
STPS10L60CF	STPS10L60CF	ISOWATT220AB	2.08g	50	Tube
STPS10L60CF	STPS10L60CF	ISOWATT220AB	2.08g	1000	Bulk
STPS10L60CFP	STPS10L60CFP	TO-220FPAB	2 g	50	Tube

- Epoxy meets UL94,V0

Information furnished is believed to be accurate and reliable. However, STMicroelectronics assumes no responsibility for the consequences of use of such information nor for any infringement of patents or other rights of third parties which may result from its use. No license is granted by implication or otherwise under any patent or patent rights of STMicroelectronics. Specifications mentioned in this publication are subject to change without notice. This publication supersedes and replaces all information previously supplied. STMicroelectronics products are not authorized for use as critical components in life support devices or systems without express written approval of STMicroelectronics.

The ST logo is a registered trademark of STMicroelectronics  
 © 2002 STMicroelectronics - Printed in Italy - All rights reserved.  
 STMicroelectronics GROUP OF COMPANIES  
 Australia - Brazil - Canada - China - Finland - France - Germany  
 Hong Kong - India - Israel - Italy - Japan - Malaysia - Malta - Morocco - Singapore  
 Spain - Sweden - Switzerland - United Kingdom - United States.

<http://www.st.com>



This datasheet has been download from:

[www.datasheetcatalog.com](http://www.datasheetcatalog.com)

Datasheets for electronics components.