

**MC34018**

**Specifications and Applications  
Information**

**VOICE SWITCHED SPEAKERPHONE CIRCUIT**

The MC34018 Speakerphone integrated circuit incorporates the necessary amplifiers, attenuators, and control functions to produce a high quality hands-free speakerphone system. Included are a microphone amplifier, a power audio amplifier for the speaker, transmit and receive attenuators, a monitoring system for background sound level, and an attenuation control system which responds to the relative transmit and receive levels as well as the background level. Also included are all necessary regulated voltages for both internal and external circuitry, allowing line-powered operation (no additional power supplies required). A Chip Select pin allows the chip to be powered down when not in use. A volume control function may be implemented with an external potentiometer. MC34018 applications include speakerphones for household and business use, intercom systems, automotive telephones, and others.

- All necessary level detection and attenuation controls for a hands-free telephone in a single integrated circuit
- Background noise level monitoring with long time constant
- Wide operating dynamic range through signal compression
- On-chip supply and reference voltage regulation
- Typical 100 mW output power (into 25 Ohms) with peak limiting to minimize distortion
- Chip Select pin for active/standby operation
- Linear Volume Control Function
- Standard 28-pin plastic DIP package (0.600 inch wide) and SOIC package

**VOICE SWITCHED  
SPEAKERPHONE CIRCUIT**

**SILICON MONOLITHIC  
INTEGRATED CIRCUIT**

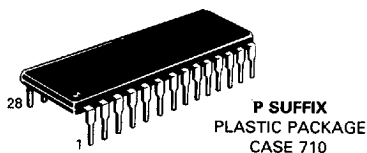

2

**BLOCK DIAGRAM**

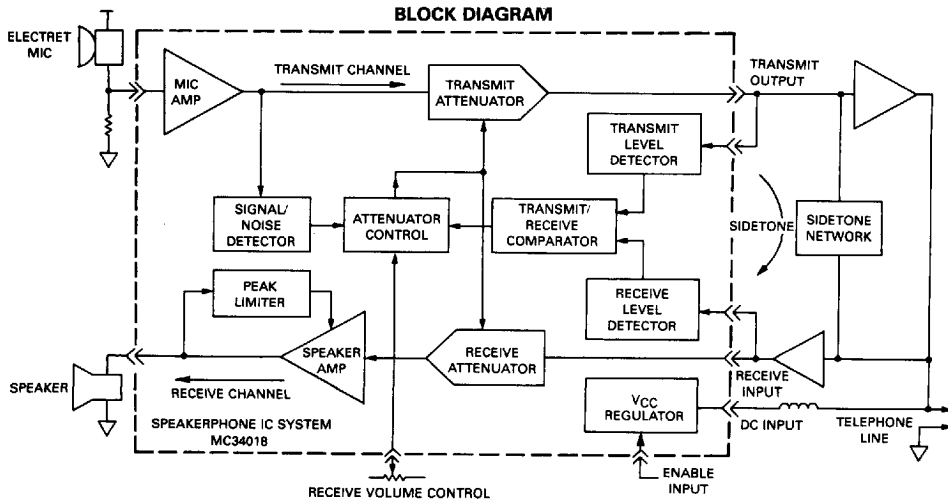

PIN DESCRIPTION

Pin	Name	Description
1	RR	A resistor to ground provides a reference current for the transmit and receive attenuators.
2	RTX	A resistor to ground determines the nominal gain of the transmit attenuator. The transmit channel gain is inversely proportional to the RTX resistance.
3	TXI	Input to the transmit attenuator. Input resistance is nominally 5.0 k ohms.
4	TXO	Output of the transmit attenuator. The TXO output signal drives the input of the transmit level detector, as well as the external circuit which drives the telephone line.
5	TLI	Input of the transmit level detector. An external resistor ac coupled to the TLI pin sets the detection level. Decreasing this resistor increases the sensitivity to transmit channel signals.
6	TLO	Output of the transmit level detector. The external resistor and capacitor set the time the comparator will hold the system in the transmit mode after speech ceases.
7	RLI	Input of the receive level detector. An external resistor ac coupled to the RLI pin sets the detection level. Decreasing this resistor increases the sensitivity to receive channel signals.
8	RLO	Output of the receive level detector. The external resistor and capacitor set the time the comparator will hold the system in the receive mode after the receive signal ceases.
9	MCI	Microphone amplifier input. Input impedance is nominally 10 k ohms and the dc bias voltage is approximately equal to VB.
10	MCO	Microphone amplifier output. The mic amp gain is internally set at 34 dB (50 V/V).
11	CP1	A parallel resistor and capacitor connected between this pin and V <sub>CC</sub> holds a voltage corresponding to the background noise level. The transmit detector compares the CP1 voltage with the speech signal from CP2.
12	CP2	A capacitor at this pin peak detects the speech signals for comparison with the background noise level held at CP1.
13	XDI	Input to the transmit detector system. The microphone amplifier output is ac coupled to the XDI pin through an external resistor.
14	SKG	High current ground pin for the speaker amp output stage. The SKG voltage should be within 10 mV of the ground voltage at Pin 22.
15	SKO	Speaker amplifier output. The SKO pin will source and sink up to 100 mA when ac coupled to the speaker. The speaker amp gain is internally set at 34 dB (50 V/V).
16	V+	Input dc supply voltage. V+ can be powered from Tip and Ring if an ac decoupling inductor is used to prevent loading ac line signals. The required V+ voltage is 6.0 to 11 V (7.5 V nominal) at 7.0 mA.

Pin	Name	Description
17	AGC	A capacitor from this pin to VB stabilizes the speaker amp gain control loop, and additionally controls the attack and decay time of this circuit. The gain control loop limits the speaker amp input to prevent clipping at SKO. The internal resistance at the AGC pin is nominally 110 k ohms.
18	CS	Digital chip select input. When at a Logic "0" (<0.7 V) the V <sub>CC</sub> regulator is enabled. When at a Logic "1" (>1.6 V), the chip is in the standby mode drawing 0.5 mA. An open CS pin is a Logic "0". Input impedance is nominally 140 k ohms. The input voltage should not exceed 11 V.
19	SKI	Input to the speaker amplifier. Input impedance is nominally 20 k ohms.
20	VCC	A 5.4 V regulated output which powers all circuits except the speaker amplifier output stage. V <sub>CC</sub> can be used to power external circuitry such as a microprocessor (3.0 mA max). A filter capacitor is required. The MC34018 can be powered by a separate regulated supply by connecting V+ and V <sub>CC</sub> to a voltage between 4.5 V and 6.5 V while maintaining CS at a Logic "1".
21	VB	An output voltage equal to approximately V <sub>CC</sub> /2 which serves as an analog ground for the speakerphone system. Up to 1.5 mA of external load current may be sourced from VB. Output impedance is 250 ohms. A filter capacitor is required.
22	Gnd	Ground pin for the IC (except the speaker amplifier).
23	XDC	Transmit detector output. A resistor and capacitor at this pin hold the system in the transmit mode during pauses between words or phrases. When the XDC pin voltage decays to ground, the attenuators switch from the transmit mode to the idle mode. The internal resistor at XDC is nominally 2.6 k ohms (see Figure 1).
24	VLC	Volume control input. Connecting this pin to the slider of a variable resistor provides receive mode volume control. The VLC pin voltage should be less than or equal to VB.
25	ACF	Attenuator control filter. A capacitor connected to this pin reduces noise transients as the attenuator control switches levels of attenuation.
26	R XO	Output of the receive attenuator. Normally this pin is ac coupled to the input of the speaker amplifier.
27	RXI	Input of the receive attenuator. Input resistance is nominally 5.0 k ohms.
28	RRX	A resistor to ground determines the nominal gain of the receive attenuator. The receive channel gain is directly proportional to the RRX resistance.

Note: Pin numbers are identical for the DIP and SOIC packages.

2

## ABSOLUTE MAXIMUM RATINGS

(Voltages referred to Pin 22) ( $T_A = 25^\circ\text{C}$ )

Parameter	Value	Units
V+ Terminal Voltage (Pin 16)	+12, -1.0	V
CS (Pin 18)	+12, -1.0	V
Speaker Amp Ground (Pin 14)	+3.0, -1.0	V
VLC (Pin 24)	$V_{CC} - 1.0$	V
Storage Temperature	-65 to +150	$^\circ\text{C}$

"Maximum Ratings" are those values beyond which the safety of the device cannot be guaranteed. They are not meant to imply that the devices should be operated at these limits. The "Electrical Characteristics" tables provide conditions for actual device operation.

## RECOMMENDED OPERATING CONDITIONS

Parameter	Value	Units
V+ Terminal Voltage (Pin 16)	+6.0 to +11	V
CS (Pin 18)	0 to +11	V
$I_{CC}$ (Pin 20)	0 to 3.0	mA
VLC (Pin 24)	0.55VB to VB	V
Receive Signal (Pin 27)	0 to 250	mV <sub>rms</sub>
Microphone Signal (Pin 9)	0 to 5.0	mV <sub>rms</sub>
Speaker Amp Ground (Pin 14)	-10 to +10	mVdc
Ambient Temperature	-20 to +60	$^\circ\text{C}$

## ELECTRICAL CHARACTERISTICS (Refer to Figure 1)

Parameter	Symbol	Pin	Min	Typ	Max	Units
-----------	--------	-----	-----	-----	-----	-------

### SUPPLY VOLTAGES

V+ Supply Current V+ = 11 V, Pin 18 = 0.7 V V+ = 11 V, Pin 18 = 1.6 V	$I_{V+}$	16	—	—	9.0 800	mA $\mu\text{A}$
$V_{CC}$ Voltage (V+ = 7.5 V) Line Regulation (6.5 V < V+ < 11 V) Output Resistance ( $I_{CC} = 3.0$ mA) Dropout Voltage (V+ = 5.0 V)	$V_{CC}$ $\Delta V_{CC LN}$ ROVCC $V_{CC SAT}$	20	4.9 — — —	5.4 65 6.0 80	5.9 150 20 300	Vdc mV ohms mV
VB Voltage (V+ = 7.5 V) Output Resistance ( $I_B = 1.7$ mA)	VB ROVB	21	2.5 —	2.9 250	3.3 —	Vdc ohms

### ATTENUATORS

Receive Attenuator Gain (@ 1.0 kHz) Rx Mode, Pin 24 = VB; Pin 27 = 250 mV <sub>rms</sub> Range (Rx to Tx Modes) Idle Mode, Pin 27 = 250 mV <sub>rms</sub>	GRX $\Delta\text{GRX}$ GRXI	26, 27	2.0 40 -20	6.0 44 -16	10 48 -12	dB dB dB
RXO Voltage (Rx Mode)	VRXO		1.8	2.3	3.2	Vdc
Delta RXO Voltage (Switch from RX to TX Mode)	$\Delta\text{VRXO}$		—	—	100	mV
RXO Sink Current (Rx Mode)	IRXOL		75	—	—	$\mu\text{A}$
RXO Source Current (Rx Mode)	IRXOH		1.0	—	3.0	mA
RXI Input Resistance	RRXI		3.5	5.0	8.0	k $\Omega$
Volume Control Range (Rx Attenuator Gain, Rx Mode, 0.6 VB < Pin 24 < VB)	VCR		24.5	—	32.5	dB

**ELECTRICAL CHARACTERISTICS** (continued)

Parameter	Symbol	Pin	Min	Typ	Max	Units
<b>ATTENUATORS</b>						
Transmit Attenuator Gain (@ 1.0 kHz) Tx Mode, Pin 3 = 250 mV <sub>rms</sub> Range, (Tx to Rx Mode) Idle Mode, Pin 3 = 250 mV <sub>rms</sub>	GTX	3,	4.0	6.0	8.0	dB
	ΔGTX	4	40	44	48	dB
	GTXI		-16.5	-13	-8.5	dB
TXO Voltage (Tx Mode)	VTXO		1.8	2.3	3.2	V <sub>dc</sub>
Delta TXO Voltage (Switch from Tx to Rx Mode)	ΔVTXO		—	—	100	mV
TXO Sink Current (Tx Mode)	I <sub>TXOL</sub>		75	—	—	μA
TXO Source Current (Tx Mode)	I <sub>TXOH</sub>		1.0	—	3.0	mA
TXI Input Resistance	R <sub>TXI</sub>		3.5	5.0	8.0	kΩ
ACF Voltage (V <sub>CC</sub> - Pin 25 Voltage) Rx Mode Rx Mode Idle Mode	ΔVACF	20,	—	150	—	mV
		25	—	6.0	—	mV
			—	75	—	mV
			—	—	—	—
<b>SPEAKER AMPLIFIER</b>						
Speaker Amp Gain (Pin 19 = 20 mV <sub>rms</sub> )	GSPK	15,	33	34	35	dB
SKI Input Resistance	R <sub>SKI</sub>	19	15	22	37	kΩ
SKO Voltage (Pin 19 = Cap Couple to GND)	V <sub>SKO</sub>		2.4	3.0	3.6	V <sub>dc</sub>
SKO High Voltage (Pin 19 = 0.1 V, -100 mA load at Pin 15)	V <sub>SKOH</sub>		5.5	—	—	V <sub>dc</sub>
SKO Low Voltage (Pin 19 = -0.1 V, +100 mA load at Pin 15)	V <sub>SKOL</sub>		—	—	600	mV
<b>MICROPHONE AMPLIFIER</b>						
Mike Amp Gain (Pin 9 = 10 mV <sub>rms</sub> , 1.0 kHz)	G <sub>MCI</sub>	9,	32.5	34	35	dB
Mike Amp Input Resistance	R <sub>MCI</sub>	10	6.5	10	16	kΩ
<b>LOGAMPS</b>						
RLO Leakage Current (Pin 8 = V <sub>B</sub> + 1.0 V)	I <sub>LKRLO</sub>	8	—	—	2.0	μA
TLO Leakage Current (Pin 6 = V <sub>B</sub> + 1.0 V)	I <sub>LKTLO</sub>	6	—	—	2.0	μA
Transmit-Receive Switching Threshold (Ratio of I <sub>TLL</sub> to I <sub>RLI</sub> — at 20 μA — to switch Tx-Rx Comparator)	I <sub>TH</sub>	5,7 25	0.8	—	1.2	
<b>TRANSMIT DETECTOR</b>						
XDC Voltage — Idle Mode Tx Mode	V <sub>XDC</sub>	23	—	0	—	V <sub>dc</sub>
			—	4.0	—	V <sub>dc</sub>
CP2 Current Source	I <sub>CP2</sub>	12	5.0	10	13	μA
<b>DISTORTION</b>						
Rx Mode — RXI to SKO (Pin 27 = 10 mV <sub>rms</sub> , 1.0 kHz)	R <sub>XD</sub>	27, 15	—	1.5	—	%
Tx Mode — MCI to TXO (Pin 9 = 5.0 mV <sub>rms</sub> , 1.0 kHz)	T <sub>XD</sub>	4,9	—	2.0	—	%

NOTES: 1. V<sub>+</sub> = 7.5 V,  $\overline{CS}$  = 0.7 V except where noted.

2. Rx Mode: Pin 7 = -100 μA, Pin 5 = +100 μA, except where noted.

Tx Mode: Pin 5, 13 = -100 μA, Pin 7 = +100 μA, Pin 11 = 0 volts.

Idle Mode: Pin 5 = -100 μA, Pin 7, 13 = +100 μA.

3. Current into a pin designated as +; current out of a pin designated as -

4. Voltages referred to Pin 22. T<sub>A</sub> = +25°C.

## TEMPERATURE CHARACTERISTICS (-20 to +60°C)

Parameter	Pin	Typical Change	Units
V+ Supply Current (V+ = 11 V, Pin 18 = 0.7 V)	16	-0.2	%/°C
V+ Supply Current (V+ = 11 V, Pin 18 = 1.6 V)	16	-0.4	%/°C
VCC Voltage (V+ = 7.5 V)	20	+0.1	%/°C
Attenuator Gain (Max and Min Settings)		±0.003	dB/°C
Delta RXO, TXO Voltages	4,26	±0.24	%/°C
Speaker Amp Gain	15,19	±0.003	dB/°C
Microphone Amp Gain	9,10	±0.001	dB/°C
Microphone Amp Input Resistance	9	+0.4	%/°C
Tx-Rx Switching Threshold (@ 20 μA)	5,7	±0.2	nA/°C

## DESIGN GUIDELINES (Refer to Figure 1)

### ATTENUATORS

The transmit and receive attenuators are complementary in function, i.e., when one is at maximum gain the other is at maximum attenuation, and vice versa. They are never both on or both off. Their main purpose is to control the transmit and receive paths to provide the half-duplex operation required of a speakerphone. The attenuators are controlled solely by the voltage at the ACF pin (Pin 25). The ACF voltage is provided by the Attenuator Control block, which receives 3 inputs: a) the Rx-Tx Comparator, b) the Transmit Detector Comparator, and c) the Volume Control. The response of the attenuators is based on the difference of the ACF voltage from VCC, and therefore a simple method for monitoring the circuit operation is to monitor this voltage difference (referred to as ΔVacf). If ΔVacf is approximately 6 millivolts the transmit attenuator is fully on and the receive attenuator is fully off (transmit mode). If ΔVacf is approximately 150 millivolts the circuit is in the receive mode. If ΔVacf is approximately 75 millivolts, the circuit is in the idle mode, and the two attenuators are at gain settings approximately half way (in dB) between their fully on and fully off positions.

The maximum gain and attenuation values are determined by the three resistors RR, RTX, and RRX (Refer to Figures 2, 3 and 4). RR affects both attenuators according to its value RELATIVE to RTX and RRX, which is why Figure 4 indicates the variations versus the ratio of the other resistors to RR. (GRX and GTX are the maximum gains, and ARX and ATX are the maximum attenuations). RTX affects the gain and attenuation of only the transmit attenuator according to the curves of Figure 2, while RRX affects only the receive attenuator according to Figure 3. As can be seen from the figures, the gain difference (from on to off) is a reasonably constant 45 dB until the upper gain limit is approached. A value of 30 k is recommended for RR as a starting point, and then RTX and RRX selected to suit the particular design goals.

The input impedance of the attenuators (at TXI and RXI) is typically 5.0 kΩ, and the maximum input signal which will not cause output distortion is 250 mVrms (707 mVp-p). The 4300 ohm resistor and 0.01 μF capacitor at RXO (in Figure 1) filters out high frequency components in the receive path. This helps minimize high frequency acoustic feedback problems which may

occur if the filter were not present. The filter's insertion loss is 1.5 dB at 1.0 kHz. The outputs of the attenuators are inverted from their inputs.

Referring to the attenuator control block, the ΔVacf voltage at its output is determined by three inputs. The relationship of the inputs and output is summarized in the following truth table:

Tx-Rx Comp	Transmit Det Comp	Volume Control	ΔVacf	Mode
Transmit	Transmit	No Effect	6.0 mV	Transmit
Transmit	Idle	No Effect	75 mV	Idle
Receive	Transmit	Affects ΔVacf	50-150 mV	Receive
Receive	Idle	Affects ΔVacf	50-150 mV	Receive

As can be seen from the truth table, the Tx-Rx comparator dominates. The Transmit Detector Comparator is effective only in the transmit mode, and the Volume Control is effective only in the receive mode.

The Tx-Rx comparator is in the transmit position when there is sufficient transmit signal present over and above any receive signal. The Transmit Detector Comparator then determines whether the transmit signal is a result of background noise (a relatively stable signal), or speech which consists of bursts. If the signal is due to background noise, the attenuators will be put into the idle mode (ΔVacf = 75 mV). If the signal consists of speech, the attenuators will be switched to the transmit mode (ΔVacf = 6.0 mV.) A further explanation of this function will be found in the section on the Transmit Detector Circuit.

The Tx-Rx comparator is in the receive position when there is sufficient receive signal to overcome the background noise AND any speech signals. The ΔVacf voltage will now be 150 mV IF the volume control is at the maximum position, i.e. VLC (Pin 24) = VB. IF VLC is less than VB, the gain of the receive attenuator, and the attenuation of the transmit attenuator, will vary in a complementary manner as shown in Figure 5. It can be seen that at the minimum recommended operating level (VLC = 0.55 VB) the gain of the transmit attenuator is actually greater than that of the receive attenuator. The effect of varying VLC is to vary ΔVacf, with a resulting variation in the gains of the attenuators. Figure 6 shows the gain variations with ΔVacf.

The capacitor at ACF (Pin 25) smooths the transition between operating modes. This keeps down any "clicks" in the speaker or transmit signal when the ACF voltage switches.

The gain separation of the two attenuators can be reduced from the typical 45 dB by adding a resistor between Pins 20 (V<sub>CC</sub>) and 25 (ACF). The effect is a reduction of the maximum  $\Delta V_{acf}$  voltage in the receive mode, while not affecting  $\Delta V_{acf}$  in the transmit mode. As an example, adding a 12 k $\Omega$  resistor will reduce  $\Delta V_{acf}$  by approximately 15 mV (to 135 mV), decrease the gain of the receive attenuator by approximately 5.0 dB, and increase the gain of the transmit attenuator by a similar amount. If the circuit requires the receive attenuator gain to be +6.0 dB in the receive mode, RRX must be adjusted (to  $\approx 27$  k) to re-establish this value. This change will also increase the receive attenuator gain in the transmit mode by a similar amount. The resistor at TLI may also require changing to reset the sensitivity of the transmit level detector.

## LOG AMPLIFIERS

### (Transmit and Receive Level Detectors)

The log amps monitor the levels of the transmit and receive signals, so as to tell the Tx-Rx comparator which mode should be in effect. The input signals are applied to the amplifiers (at TLI and RLI) through AC coupling capacitors and current limiting resistors. The value of these components determines the sensitivity of the respective amplifiers, and has an effect on the switching times between transmit and receive modes. The feedback elements for the amplifiers are back-to-back diodes which provide a logarithmic gain curve, thus allowing operation over a wide range of signal levels. The outputs of the amplifiers are rectified, having a quick rise time and a slow decay time. The rise time is determined primarily by the external capacitor (at TLO or RLO) and an internal 500 ohm resistor, and is on the order of a fraction of a millisecond. The decay time is determined by the external resistor and capacitor, and is on the order of a fraction of a second. The switching time is not fixed, but depends on the relative values of the transmit and receive signals, as well as these external components. Figure 7 indicates the dc transfer characteristics of the log amps, and Figure 8 indicates the transfer characteristics with respect to an ac input signal. The dc level at TLI, RLI, TLO, and RLO is approximately VB.

The Tx-Rx comparator responds to the voltages at TLO and RLO, which in turn are functions of the currents sourced out of TLI and RLI, respectively. If an offset at the comparator input is desired, e.g., to prevent noise from switching the system, or to give preference to either the transmit or receive channel, this may be achieved by biasing the appropriate input (TLI or RLI). A resistor to ground will cause a DC current to flow out of that input, thus forcing the output of that amplifier to be biased slightly higher than normal. This amplifier then becomes the preferred one in the system operation. Resistor values from 500 k to 10 M ohms are recommended for this purpose.

## SPEAKER AMPLIFIER

The speaker amplifier has a fixed gain of 34 dB (50 V/V), and is noninverting. The input impedance is nominally 22 k $\Omega$  as long as the output signal is below that required to activate the Peak Limiter. Figure 9 indicates the typical output swing available at SKO (Pin 15). Since the output current capability is 100 mA, the lower curve is limited to a 5.0 volt swing. The output impedance depends on the output signal level and is relatively low as long as the signal level is not near the maximum limits. At 3 volts p-p the output impedance is <0.5 ohms, and at 4.5 volts p-p it is <3 ohms. The output is short circuit protected at approximately 300 mA.

When the amplifier is overdriven, the peak limiter causes a portion of the input signal to be shunted to ground, in order to maintain a constant output level. The effect is that of a gain reduction caused by a reduction of the input impedance (at SKI) to a value not less than 2.0 k $\Omega$ .

The capacitor at Pin 17 (AGC) determines the response time of the peak limiter circuit. When a large input signal is applied to SKI, the voltage at AGC (Pin 17) will drop quickly as a current source is applied to the external capacitor. When the large input signal is reduced, the current source is turned off, and an internal 110 k $\Omega$  resistor discharges the capacitor so the voltage at AGC can return to its normal value (1.9 Vdc). The capacitor additionally stabilizes the peak limiting feedback loop.

If there is a need to mute the speaker amplifier without disabling the rest of the circuit, this may be accomplished by connecting a resistor from the AGC pin to ground. A 100 k $\Omega$  resistor will reduce the gain by 34 dB (0 dB from SKI to SKO), and a 10 k resistor will reduce the gain by almost 50 dB.

## TRANSMIT DETECTOR CIRCUIT

The transmit detector circuit, also known as the background noise monitor, distinguishes speech (which consists of bursts) from the background noise (a relatively constant signal). It does this by storing a voltage level, representative of the average background noise, in the capacitor at CP1 (Pin 11). The resistor and capacitor at this pin have a time constant of approximately 5 seconds (in Figure 1). The voltage at Pin 11 is applied to the inverting input of the Transmit Detector Comparator. In the absence of speech signals, the noninverting input receives the same voltage level minus an offset of 36 mV. In this condition, the output of the comparator will be low, the output transistor turned off, and the voltage at XDC (Pin 23) will be at ground. If the Tx-Rx comparator is in the transmit position, the attenuators will be in the idle mode ( $\Delta V_{acf}$  = 75 mV). When speech is presented to the microphone, the signal burst appearing at XDI reaches the noninverting input of the transmit detector comparator before the voltage at the inverting input can change, causing the output to switch high, driving the voltage at XDC up to approximately 4 volts. This high level causes the attenuator control block to switch the attenuators from the idle mode to the transmit mode (assuming the Tx-Rx comparator is in

the transmit mode). As long as the speech continues to arrive, and is maintained at a level above the background, the voltage at XDC will be maintained at a high level, and the circuit will remain in the transmit mode. The time constant of the components at XDC will determine how much time the circuit requires to return to the idle mode after the cessation of microphone speech signals, such as occurs during the normal pauses in speech.

The series resistor and capacitor at XDI (Pin 13) determine the sensitivity of the transmit detector circuit. Figure 10 indicates the change in DC voltage levels at CP2 and CP1 in response to a steady state sine wave applied at the input of the 0.068  $\mu$ F capacitor and 4700 ohm resistor (the voltage change at CP1 is 2.7 times greater than the change at CP2). Increasing the resistor, or lowering the capacitor, will reduce the response at these pins. The first amplifier (between XDI and CP2) is logarithmic in order that this circuit be able to handle a wide range of signal levels (or in other words, it responds equally well to people who talk quietly and to people who shout). Figure 7 indicates the dc transfer characteristics of the log amp.

Figure 11 indicates the response at Pins 11, 12, and 23 to a varying signal at the microphone. The series of events in Figure 11 is as follows:

- 1) CP2 (Pin 12) follows the peaks of the speech signals, and decays at a rate determined by the 10  $\mu$ A current source and the capacitor at this pin.
- 2) CP1 (Pin 11) increases at a rate determined by the RC at this pin after CP2 has made a positive transition. It will follow the decay pattern of CP2.
- 3) The noninverting input of the Transmit Detector Comparator follows CP2, gained up by 2.7, and reduced by an offset of 36 mV. This voltage, compared to CP1, determines the output of the comparator.
- 4) XDC (Pin 23) will rise quickly to 4 Vdc in response to a positive transition at CP2, but will decay at a rate determined by the RC at this pin. When XDC is above 3.25 Vdc, the circuit will be in the transmit mode. As it decays towards ground, the attenuators are taken to the idle mode.

**MICROPHONE AMPLIFIER**

The microphone amplifier is noninverting, has an internal gain of 34 dB (50 V/V), and a nominal input impedance of 10 k $\Omega$ . The output impedance is typically <15 ohms. The maximum p-p voltage swing available at the output is approximately 2.0 volts less than V<sub>CC</sub>, which is substantially more than what is required in most applications. The input at MCI (Pin 9) should be ac coupled to the microphone so as to not upset the bias voltage. Generally, microphone sensitivity may be adjusted by varying the 2 k microphone bias resistor, rather than by attempting to vary the gain of the amplifier.

**POWER SUPPLY**

The voltage supply for the MC34018 at V+ (Pin 16) should be in the range of 6.0 to 11 volts, although the circuit will operate down to 4.0 volts. The voltage can be supplied either from Tip and Ring, or from a separate

supply. The required supply current, with no signal to the speaker, is shown in Figure 12. The upper curve indicates the normal operating current when Chip Select (Pin 18) is at a Logic "0". Figure 13 indicates the average dc current required when supplying various power levels to a 25 ohm speaker. Figure 13 also indicates the minimum supply voltage required to provide the indicated power levels. The peak in the power supply current at 5.0–5.4 volts occurs as the V<sub>CC</sub> circuit comes into regulation.

It is imperative that the V+ supply (Pin 16) be a good ac ground for stability reasons. If this pin is not well filtered (by a 1000  $\mu$ F capacitor AT THE IC), any variation at V+ caused by the required speaker current flowing through this pin can cause a low frequency oscillation. The result is usually that the circuit will cut the speaker signal on and off at the rate of a few hertz. Experiments have shown that only a few inches of wire between the supply and the IC can cause the problem if the filter capacitor is not physically adjacent to the IC. It is equally imperative that both ground pins (Pins 14 and 22) have a low loss connection to the power supply ground.

**V<sub>CC</sub>**

V<sub>CC</sub> (Pin 20) is a regulated output voltage of 5.4 volts, +/- 0.5 V. Regulation will be maintained as long as V+ is (typically) 80 mV greater than the regulated value of V<sub>CC</sub>. Up to 3 milliamps can be sourced from this supply for external use. The output impedance is <20 ohms.

The 47  $\mu$ F capacitor indicated for connection to Pin 20 is essential for stability reasons. It must be located adjacent to the IC.

If the circuit is deselected (see section on Chip Select), the V<sub>CC</sub> voltage will go to 0 volts.

If the MC34018 is to be powered from a regulated supply (not the Tip and Ring lines) of less than 6.5 volts, the configuration of Figure 14 may be used so as to ensure that V<sub>CC</sub> is regulated. The regulated voltage is applied to both V+ and V<sub>CC</sub>, with  $\overline{CS}$  held at a Logic "1" so as to turn off the internal regulator (the Chip Select function is not available when the circuit is used in this manner). Figure 15 indicates the supply current used by this configuration, with no signal at the speaker. When a signal is sent to the speaker, the curves of Figure 13 apply.

**VB**

VB is a regulated output voltage with a nominal value of 2.9 volts, +/- 0.4 volts. It is derived from V<sub>CC</sub> and tracks it, holding a value of approximately 54% of V<sub>CC</sub>. 1.5 milliamps can be sourced from this supply at a typical output impedance of 250 ohms.

The 47  $\mu$ F capacitor indicated for connection to the VB pin is required for stability reasons, and must be adjacent to the IC.

If the circuit is deselected (see section on Chip Select), the VB voltage will go to 0 volts.

## CHIP SELECT

The Chip Select pin (Pin 18) allows the chip to be powered down anytime its functions are not required. A Logic "1" level in the range of 1.6 V to 11 V deselects the chip, and the resulting supply current (at V+) is

shown in Figure 12. The input resistance at Pin 18 is  $>75\text{ k}\Omega$ . The VCC and VB regulated voltages go to 0.0 when the chip is deselected. Leaving Pin 18 open is equivalent to a Logic "0" (chip enabled).

FIGURE 1 — TEST CIRCUIT

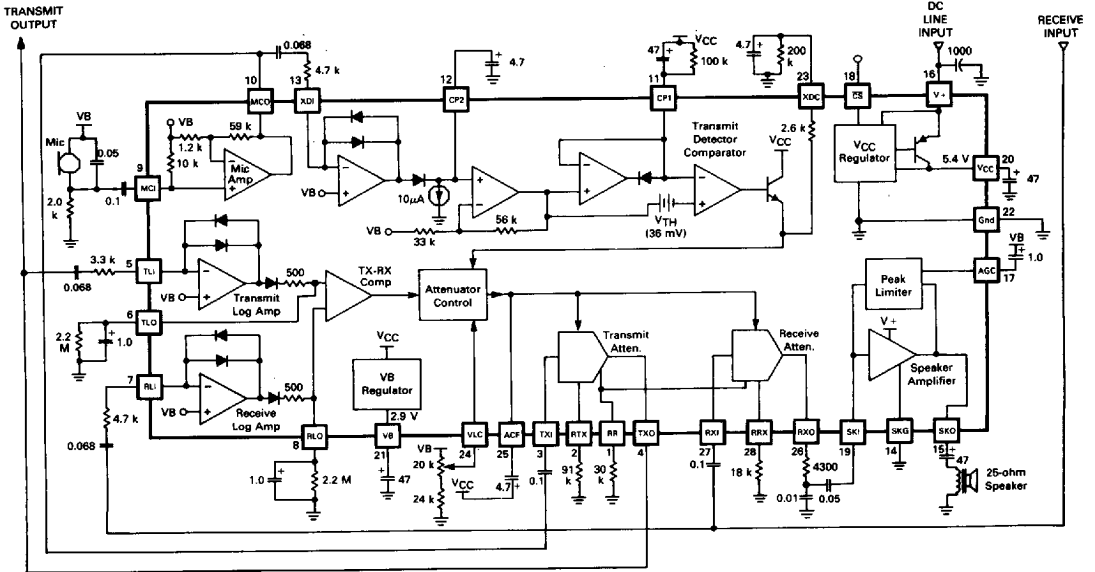

FIGURE 2 — TRANSMIT ATTENUATOR versus RTX

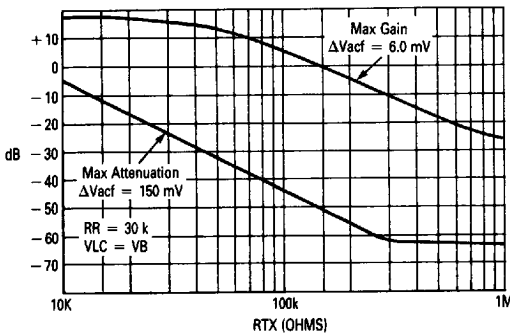
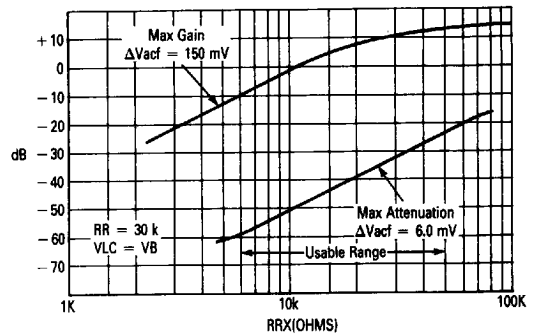
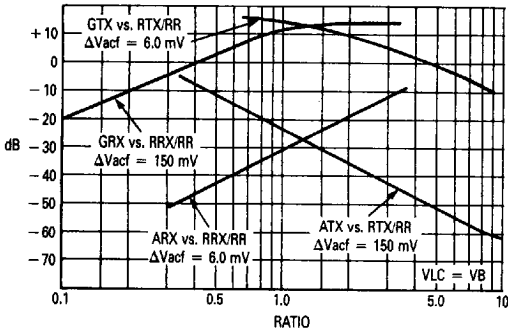

FIGURE 3 — RECEIVE ATTENUATOR versus RRX

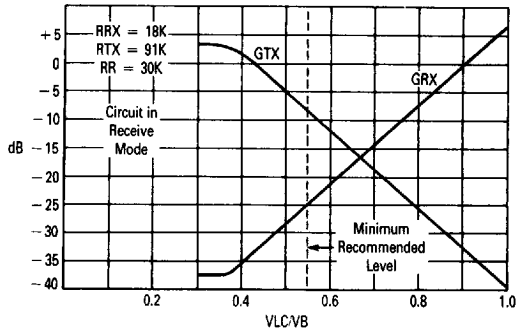



**FIGURE 4 — GAIN AND ATTENUATION  
versus RESISTOR RATIOS**



**FIGURE 5 — ATTENUATOR GAIN versus VLC**



**FIGURE 6 — ATTENUATOR GAIN versus ΔVacf**

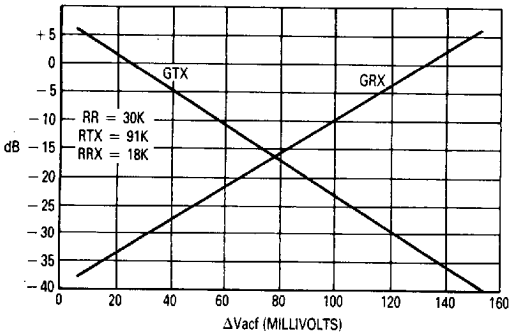

**FIGURE 7 — LOG AMP TRANSFER CHARACTERISTICS**

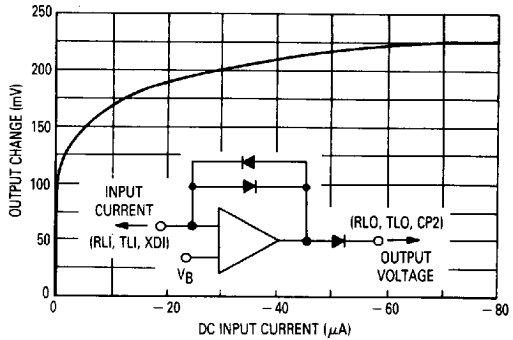

**FIGURE 8 — LOG AMP TRANSFER CHARACTERISTICS**

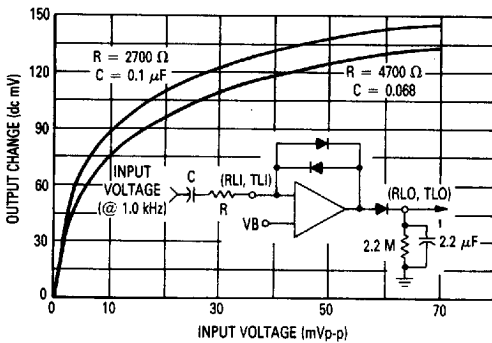

**FIGURE 9 — SPEAKER AMP OUTPUT versus SUPPLY VOLTAGE**

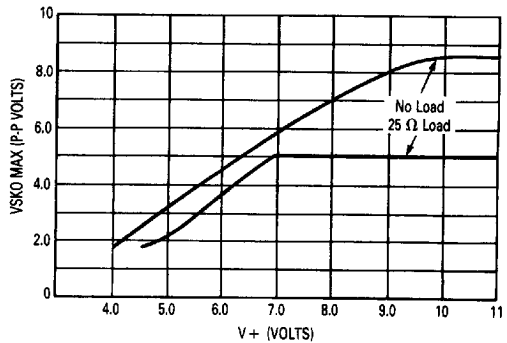

FIGURE 10 — RESPONSE AT CP2 AND CP1

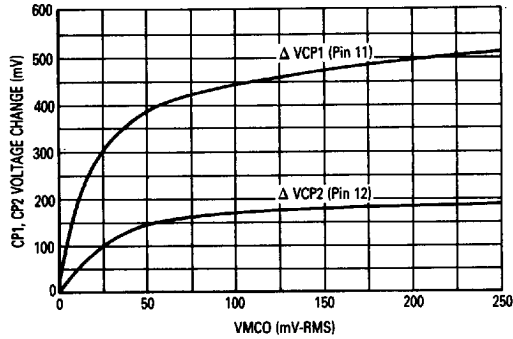

FIGURE 11 — TRANSMIT DETECTOR OPERATION

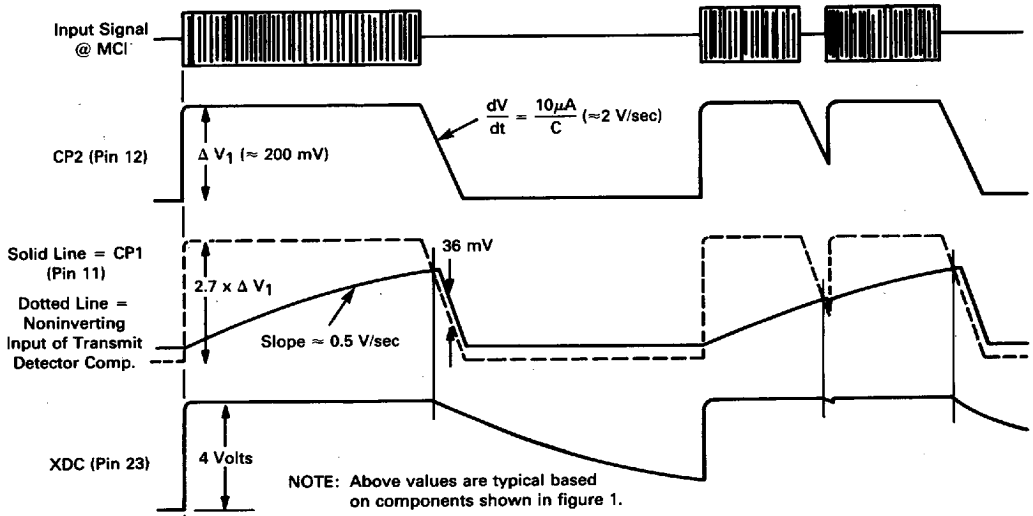

FIGURE 12 — SUPPLY CURRENT versus SUPPLY VOLTAGE

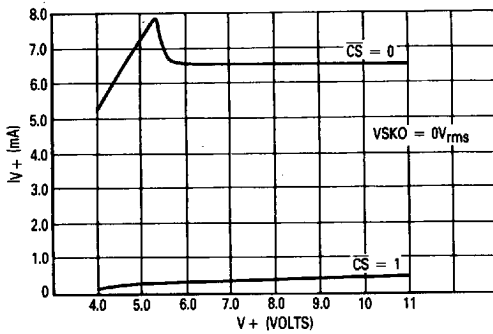

FIGURE 13 — SUPPLY CURRENT versus SUPPLY VOLTAGE versus SPEAKER POWER

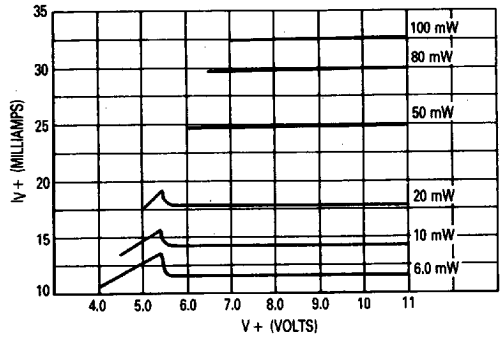

FIGURE 14 — ALTERNATE POWER SUPPLY CONFIGURATION

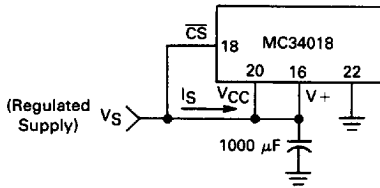
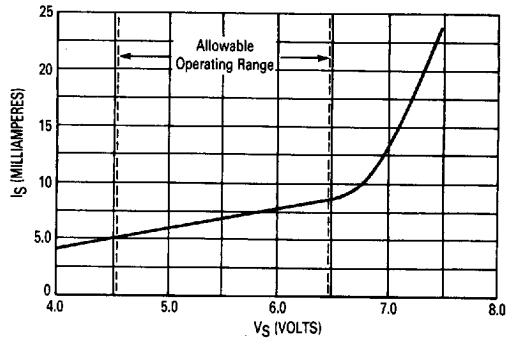

FIGURE 15 — SUPPLY CURRENT versus SUPPLY VOLTAGE (SEE FIGURE 14)



**SWITCHING TIME**

The switching times of the speakerphone circuit depend not only on the various external components, but also on the operating condition of the circuit at the time a change is to take effect. For example, the switching time from idle to transmit is generally quicker than the switching time from receive to transmit (or transmit to receive).

The components which most significantly affect the timing between the transmit and receive modes are those at Pins 5 (transmit turn-on), 6 (transmit turn-off), 7 (receive turn-on), and 8 (receive turn-off). These four timing functions are not independent, but interact since the Tx-Rx comparator operates on a RELATIVE Tx-Rx comparison, rather than on absolute values. The components at Pins 11, 12, 13, and 23 affect the timing from the transmit to the idle mode. Timing from the idle mode to transmit mode is relatively quick (due to the quick charging of the various capacitors), and is not greatly affected by the component values. Pins 5-8 do not affect the idle-to-transmit timing since the Tx-Rx comparator must already be in the transmit mode for this to occur.

The following table provides a summary of the effect on the switching time of the various components, including the volume control:

Components	Tx to Rx	Rx to Tx	Tx to Idle
RC @ Pin 5	Moderate	Significant	No effect
RC @ Pin 6	Significant	Moderate	No effect
RC @ Pin 7	Significant	Moderate	No effect
RC @ Pin 8	Moderate	Significant	No effect
RC @ Pin 11	No effect	Slight	Moderate
C @ Pin 12	No effect	Slight	Significant
RC @ Pin 13	No effect	Slight	Slight
RC @ Pin 23	No effect	Slight	Significant
V @ Pin 24	No effect	Moderate	No effect
C @ Pin 25	Moderate	Moderate	Slight

Additionally, the following should be noted:

- 1) The RCs at Pins 5 and 7 have a dual function in that they affect the sensitivity of the respective log amplifiers, or in other words, how loud the speech must be in order to gain control of the speakerphone circuit.
- 2) The RC at Pin 13 also has a dual function in that it determines the sensitivity of the transmit detector circuit.
- 3) The volume control affects the switching speed, and the relative response to transmit signals, in the following manner: When the circuit is in the receive mode, reducing the volume control setting increases the signal at TXO, and consequently the signal to the TLI pin. Therefore a given signal at TXI will switch the circuit into the transmit mode quicker at low volume settings.

The photographs of Figures 16 and 17 indicate experimentally obtained switching response times for the circuit of Figure 1. In Figure 16, the circuit is provided a continuous receive signal of 1.1 mVp-p at RXI (trace #3). A repetitive burst signal of 7.2 mVp-p, lasting 120

milliseconds, and repeated every 1 second, is applied to MCI (Trace #1). Trace #2 is the output at TXO, and is approximately 650 mVp-p at its maximum. Trace #4 is the output at RXO, and is approximately 2.2 mVp-p at its maximum. The time to switch from the receive mode to the transmit mode is approximately 40 ms, as indicated by the time required for TXO to turn on, and for RXO to turn off. After the signal at MCI is shut off, the switching time back to the receive mode is approximately 210 ms.

In Figure 17, a continuous signal of 7.6 mVp-p is applied to MCI (Trace #1), and a repetitive burst signal of 100 mVp-p is applied to RXI (Trace #3), lasting approximately 120 ms, and repeated every 1 second. Trace #2

is the output at TXO and is approximately 90 mVp-p at its maximum, and Trace #4 indicates the output at RXO, and is approximately 150 mVp-p at its maximum. In this sequence, the circuit switches between the idle and receive modes. The time required to switch from idle to receive is approximately 70 ms, as indicated by the first part of Traces 2 and 4. After the receive signal is shut off, the time to switch back to the idle mode is approximately 100 ms.

All of the above mentioned times will change significantly by varying the amplitude of the input signals, as well as by varying the external components.

FIGURE 16 — TRANSMIT-RECEIVE SWITCHING

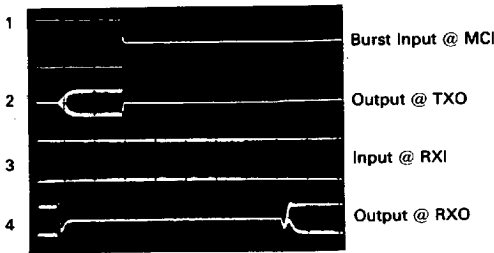

Time Base = 40 ms/Div

FIGURE 17 — IDLE-RECEIVE SWITCHING

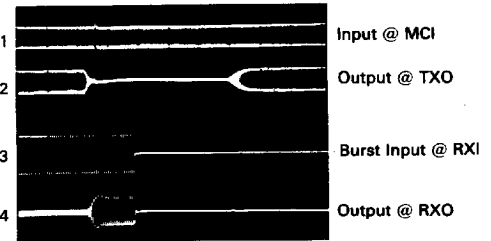

Time Base = 30 ms/Div

### APPLICATIONS INFORMATION

The MC34018 Speakerphone IC is designed to provide the functions additionally required when a speakerphone is added to a standard telephone. The IC provides the necessary relative level detection and comparison of the speech signals provided by the talkers at the speakerphone (near end speaker) and at the distant telephone (far end speaker).

The MC34018 is designed for use with an electret type microphone, a 25 ohm speaker, and has an output power capability of (typically) 100 mW. All external components surrounding this device are passive, however, this IC does require additional circuitry to interface to the Tip and Ring telephone lines. Two suggested circuits are shown in this data sheet.

Figure 18 depicts a circuit using the MC34014 Speech Network (to provide the line interface), as well as the circuitry necessary to switch between the handset mode and the speakerphone mode. Switch HS (containing one normally open and one normally closed contact) is the hook switch actuated by the handset, shown in the on-hook position. When the handset is off-hook (HS1 open, HS2 closed), power is applied to the MC34014 speech network, and consequently the handset, and the  $\overline{CS}$  pin of the MC34018 is held high so as to disable it. Upon closing the two poles of switch SS, AND placing switch

HS in the on-hook position, power is then applied to both the MC34014 and the MC34018, and  $\overline{CS}$  is held low, enabling the speakerphone function. Anytime the handset is removed from switch HS, the circuit reverts to the handset mode. The diode circuitry sets the operational mode of the MC34014 so as to optimize the speakerphone operation (see the MC34014 data sheet for further details). The tone dialer interface is meant for connection to a DTMF dialer with an active low MUTE signal. The  $V_{DD}$  supply from the MC34014 is a nominal 3.3 volts. The MC34017 and piezo sounder provide the ringing function.

Figure 19 depicts a configuration which does not include a handset, dialer, or ringer. The only controls are S1 (to make the connection to the line), S2 (a "privacy" switch), and the volume control. It is meant to be used in parallel with a normal telephone which has the dialing and ringing functions.

Figure 20 depicts a means of providing logic level signals that indicate which mode of operation the MC34018 is in. Comparator A indicates whether the circuit is in the receive or transmit/idle mode, and comparator B indicates (when in the transmit/idle mode) whether the circuit is in the transmit or idle mode. The LM393 dual comparator was chosen because of its low current requirement (<1.0 mA), low voltage requirement (as low as 2.0 volts), and low cost.

FIGURE 18 — SWITCHABLE HANDSET/HANDSFREE SYSTEM

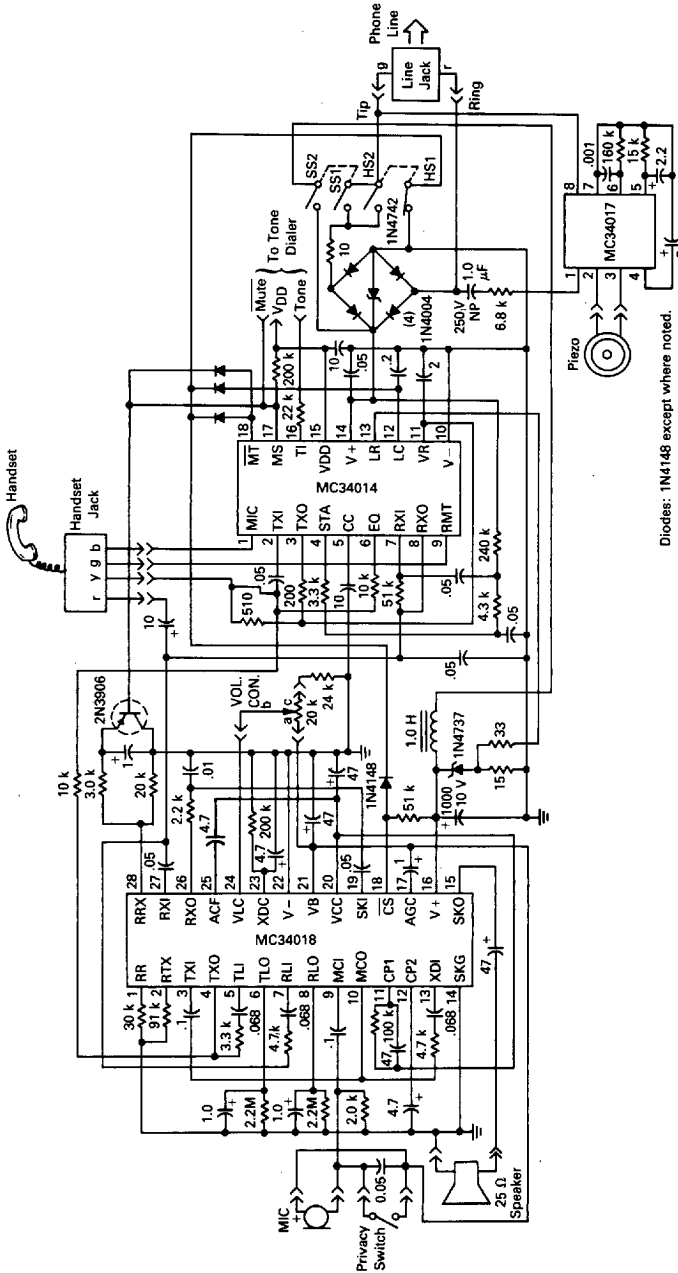

Diodes: 1N4148 except where noted.

FIGURE 19 — BASIC LINE POWERED SPEAKERPHONE

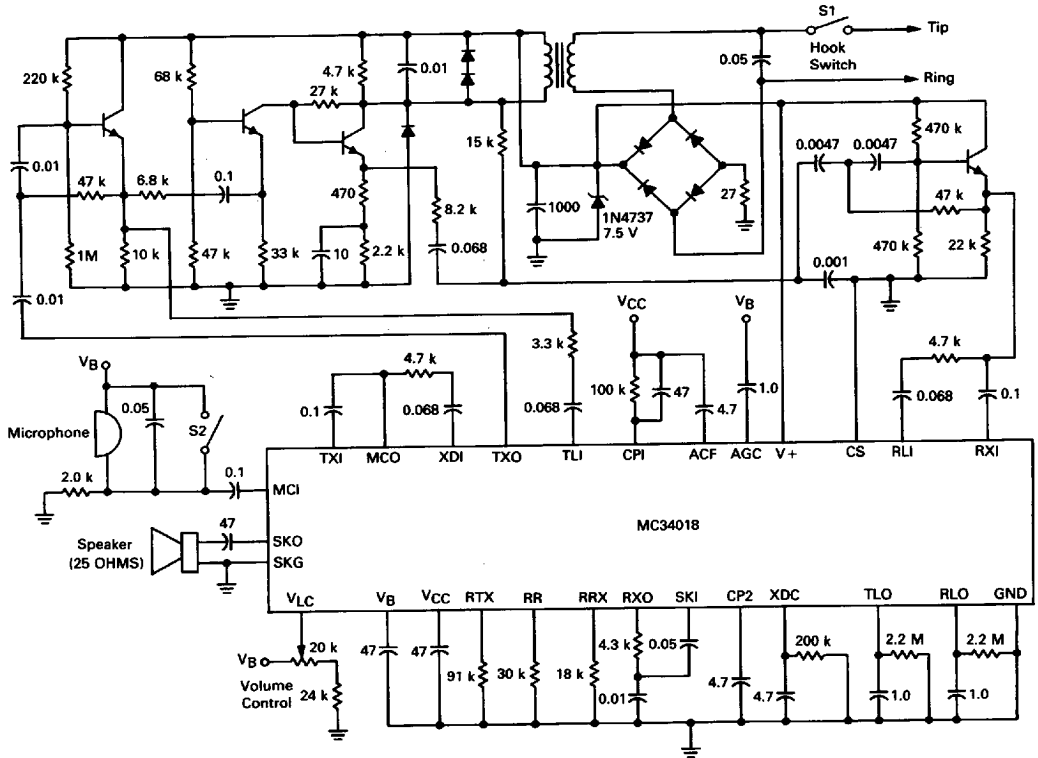

1. Diodes are 1N4001 unless otherwise noted.
2. 4 Transistors are 2N3904.
3. Recommended Transformer: Microtran T5115.

FIGURE 20 — DIGITAL TRANSMIT/IDLE/RECEIVE INDICATION

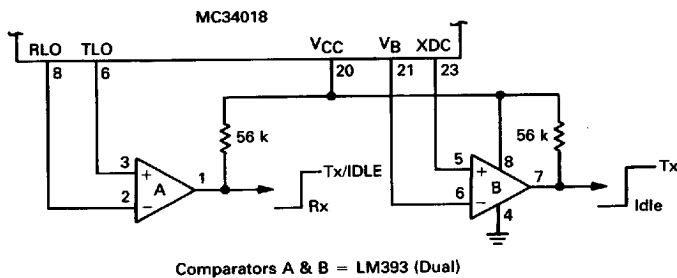

Comparators A & B = LM393 (Dual)

MC34018  
2-496

6367253 0095475 487

MOTOROLA

This datasheet has been download from:

[www.datasheetcatalog.com](http://www.datasheetcatalog.com)

Datasheets for electronics components.