



SANYO Semiconductors

DATA SHEET

LA47510 — Monolithic Linear IC

BTL (50W×4) Power IC for Car Stereo Systems

Overview

The LA47510 is a BTL 4-channel (50W×4) power IC for car stereo. The output stage uses a pure complementary format with a V-PNP transistor on the upper side and a NPN transistor on the lower side, making it possible to obtain high power output and excellent sound quality.

This IC incorporates various functions (standby switch, mute function, full complement of protection circuits) needed for car audio, and also has a self-check (output offset detection) function.

Functions & Features

- 50W×4 maximum output (at VCC=14.4V, RL=4Ω)
- Very low external component count
- Onchip offset detector
- Onchip offset detector shutoff switch
- Mute function
- Standby switch
- Full complement of protection circuits (including shorting to the power supply, shorting to ground, load short-circuit, overvoltage, thermal protection)

Caution 1: Never make wrong connection. A wrong connection would cause fatal damage or performance degradation to the IC or equipment.

Caution 2: The protective circuit functions are provided to temporarily avoid abnormal states such as incorrect output connections, and do not guarantee that IC destruction will not occur.

These protective functions do not operate outside of the operation guarantee range. If the outputs are connected incorrectly, IC destruction may occur when used outside of the operation guarantee range.

Specifications

Maximum Ratings at Ta=25°C

Parameter	Symbol	Test Conditions	Ratings	unit
Maximum supply voltage	V _{CC} max1	No signal, t=1 minute	26	V
	V _{CC} max2	With signal	18	V
Maximum output current	I _O peak	Per channel	4.5	A
Maximum power dissipation	P _d max	With infinite heat sink (note)	50	W
Operating ambient temperature	T _{opg}		-40 to +85	°C
Storage ambient temperature	T _{stg}		-40 to +150	°C
Junction-to-case thermal resistance	θ _{j-c}		1	°C/W

■ Any and all SANYO products described or contained herein do not have specifications that can handle applications that require extremely high levels of reliability, such as life-support systems, aircraft's control systems, or other applications whose failure can be reasonably expected to result in serious physical and/or material damage. Consult with your SANYO representative nearest you before using any SANYO products described or contained herein in such applications.

■ SANYO assumes no responsibility for equipment failures that result from using products at values that exceed, even momentarily, rated values (such as maximum ratings, operating condition ranges, or other parameters) listed in products specifications of any and all SANYO products described or contained herein.

LA47510

Note: Power consumption (Pd), junction-to-case thermal resistance (θ_{j-c}), heat sink thermal resistance (θ_f), junction temperature (Tj), case temperature (Tc) and ambient temperature (Ta) have the relationship shown in the following equation.

$$T_j = P_d(\theta_{j-c} + \theta_f) + T_a$$

$$= P_d \times \theta_{j-c} + T_c, \quad *T_c = P_d \times \theta_f + T_a \quad \text{However, } T_j \text{ max is limited by } T_{stg \text{ max}} (150^\circ\text{C})$$

Recommended Operation Conditions at Ta=25°C

Parameter	Symbol	Test Conditions	Ratings	unit
Supply voltage	V _{CC}		14.4	V
Load resistance	R _L		4	Ω
Operating supply voltage range	V _{CC op}	P _{dmax} shall not be exceeded.	9 to 18	V

Electrical Characteristics at Ta=25°C, V_{CC}=14.4V, f=1kHz, R_L=4Ω, R_g=600Ω

Parameter	Symbol	Test Conditions	min	typ	max	unit
Quiescent current	I _{CCO}	R _L =∞, R _g =0		200	400	mA
Standby current	I _{st}	V _{st} =0V			10	μA
Output offset voltage	V _{n offset}	R _g =0	-100		+100	mV
Voltage gain	V _G	V _o =0dBm	25	26	27	dB
Voltage gain difference	ΔV _G		-1		+1	dB
Output power	P _{O1}	THD=10%	24	29		W
	P _{O max1}	V _{CC} =13.7V, V _{in} =5Vrms		43		W
	P _{O max2}	V _{in} =5Vrms		48		W
Total harmonic distortion	THD	P _o =4W		0.05	0.3	%
Channel separation	CHsep	V _o =0dBm, R _g =10kΩ	55	65		dB
Ripple rejection ratio	SVRR	f _r =100Hz, V _{ccr} =0dBm, R _g =0 B.P.F=20Hz to 20kHz	45	55		dB
Output noise voltage	V _{NO}	R _g =0, B.P.F=20Hz to 20kHz		150	250	μVrms
Mute attenuation	Ma	V _o =20dBm	70	90		dB
Output middle point voltage	V _n	R _g =0		2.65		V

*0dBm=0.775Vrms

Package Dimensions

Unit: mm

3236

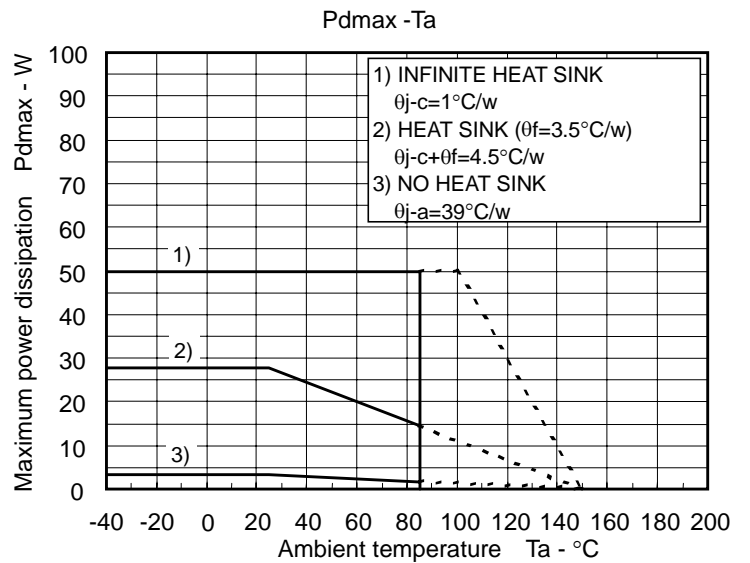
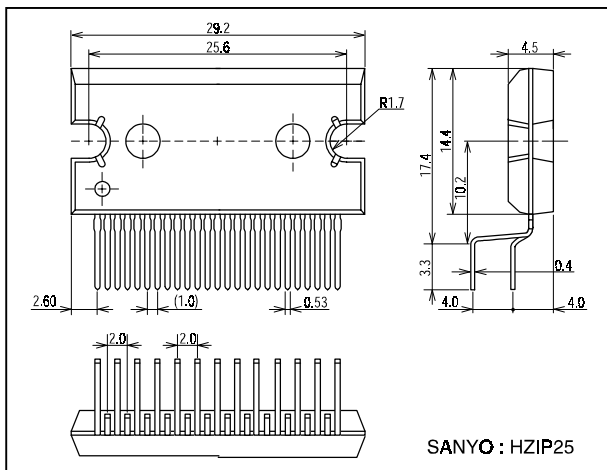

Block and Test Circuit Diagram

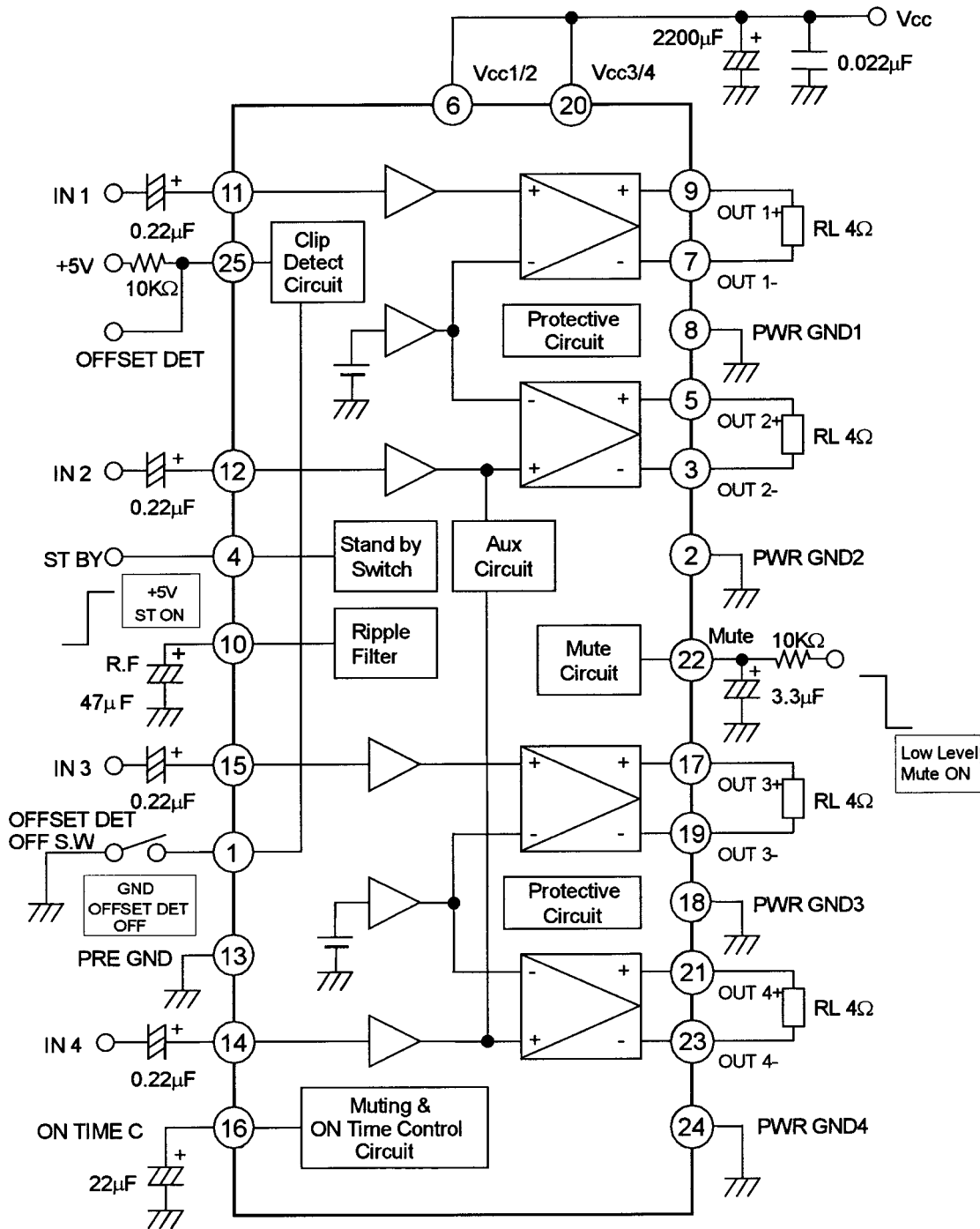

Note: The components and constant values within the test circuit are used to confirm the characteristics, and are not guarantees that incorrect operation or other trouble will not occur in applied equipment.

Description of Operation

1. Standby switch function (pin 4)

The Pin 4 threshold voltage is set to $2 V_{BE}$, and the amplifier turns on when $V_{st} = 2.0 \text{ V}$ or higher, and off when $V_{st} = 0.7 \text{ V}$ or lower. In addition, Pin 4 requires an operating current of $40 \mu\text{A}$ or more.

Note: Do not ground the output with the Pin 4 voltage at approximately 1.4 V . In addition, do not give the Pin 4 voltage a time constant.

2. Mute function

Mute mode is established and the audio can be muted by connecting Pin 22 to GND through $10 \text{ k}\Omega$.

The mute time constant is determined by the external capacitor and resistor constants. The recommended external constants are $C = 3.3 \mu\text{F}$, $R = 10 \text{ k}\Omega$.

3. Self-check function (loudspeaker burnout prevention)

Pin 25 is used to check, during normal operation, for any abnormality in the offset level of the amplifier and generates a signal when an abnormal level is detected. Speaker burnout can be prevented by detecting this Pin 25 signal with a microcontroller or other device and controlling the standby power supply, etc. (Output offset errors are thought to be caused by the leak current of the input capacitor, etc.)

In addition, the Pin 25 signal can be turned off by setting Pin 1 to the GND potential.

4. Oscillation stability

Parasitic oscillation may be induced depending on the board layout.

Countermeasures against oscillation can be taken by adding the following parts.

Note that the following are only examples for reference, and that the optimum capacitance values must be confirmed in the mounted condition for each set.

- Connect a Mylar capacitor ($0.033 \mu\text{F}$) between the BTL outputs.
- Connect a capacitor and a resistor ($0.1 \mu\text{F}$ and 2.2Ω in series) between each output and GND.

5. Sound quality (low frequencies)

The frequency response in the low frequency range can be improved by varying the capacitance value of the input capacitor. The recommended value is $2.22 \mu\text{F}$ or less.

6. Shock noise

This IC incorporates a shock noise canceling circuit, and the shock noise canceling performance can be further improved by using together with the mute function.

- When turning on the amplifier, turn the power supply and the mute function on at the same time. Then turn the mute function off after the output current potential has stabilized.
- When turning off the amplifier, first turn the mute function off and then turn the power supply off.

7. Using the pin 25 function and the pin 1 off function

(1) Offset detection function (Pin 25)

Output offsets can be detected by directly monitoring the pin potential in the condition with 5 V applied through a $10 \text{ k}\Omega$ resistor. When an offset is detected, the Pin 25 potential falls from 5 V to 0 V .

* The voltage level at pin 25 swings up and down in synchronization with the output signal when the LA47510 is in the normal operating state.

(2) Offset detection function OFF switch (Pin 1)

The offset detection function (Pin 25) can be turned off by connecting Pin 1 to GND. Leave Pin 1 open during normal operation.

8. Electric mirror noise suppression measures

Electric mirror noise can be reduced by inserting a bypass capacitor between the output and GND.

For reference, the standard value is approximately 470 pF and the maximum value is approximately 2200 pF .

However, note that inserting a bypass capacitor will cause the oscillation stability to worsen, so thorough investigation of anti-oscillation measures should be made in the set condition before use.

Characteristics Charts

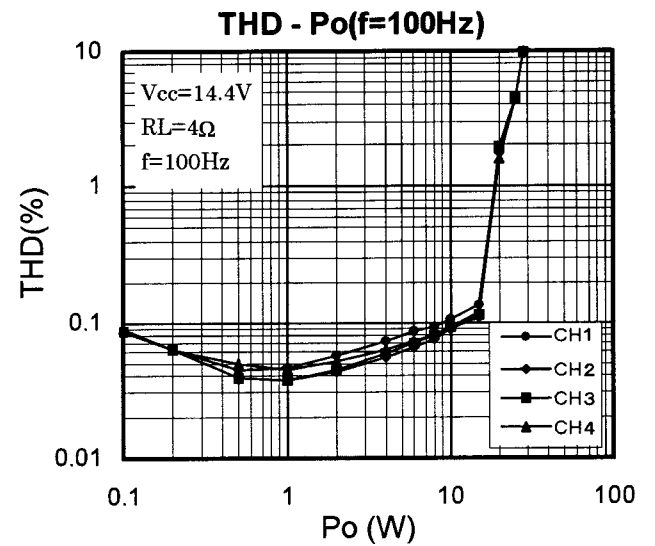
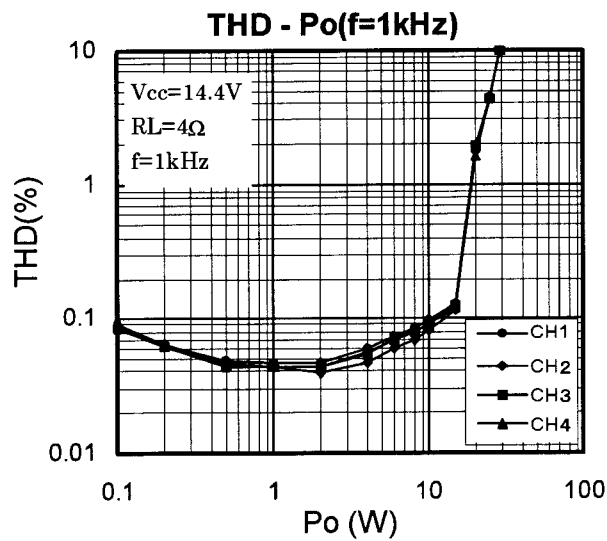
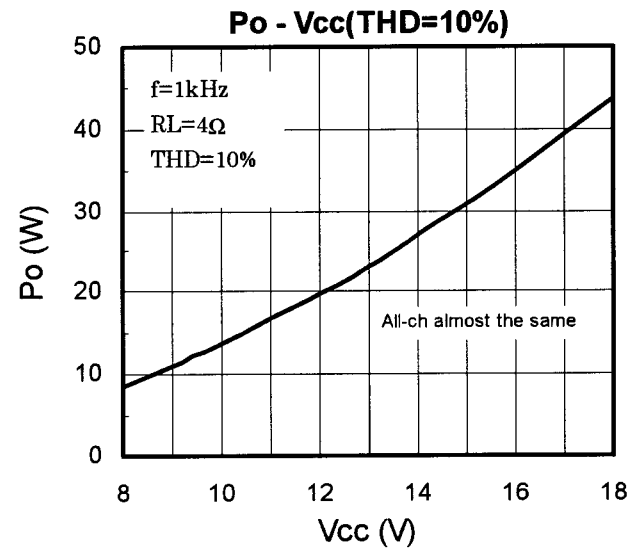
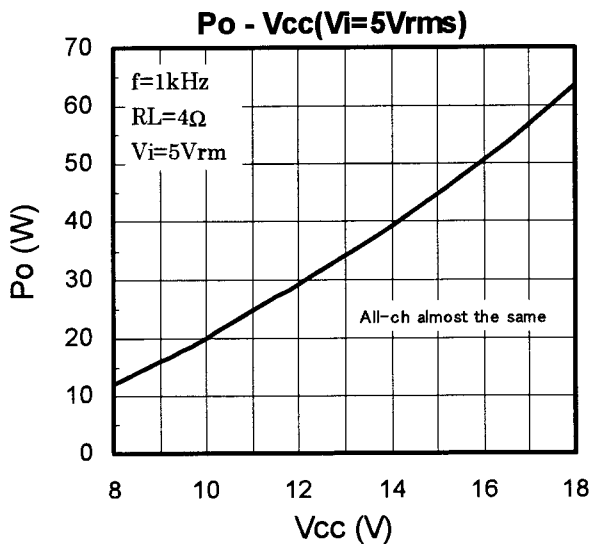
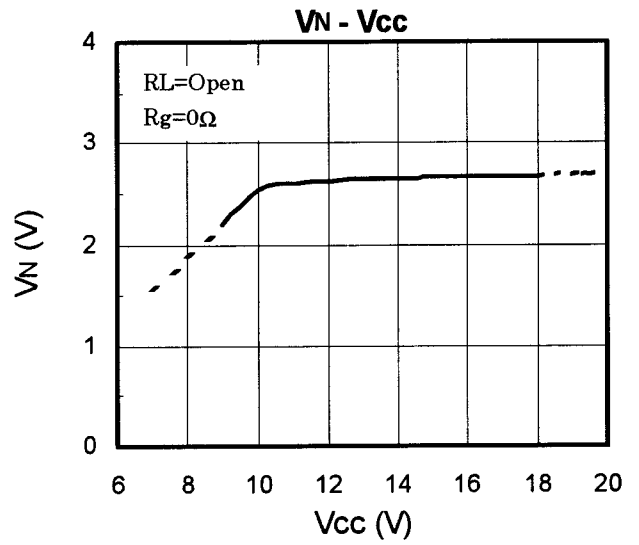
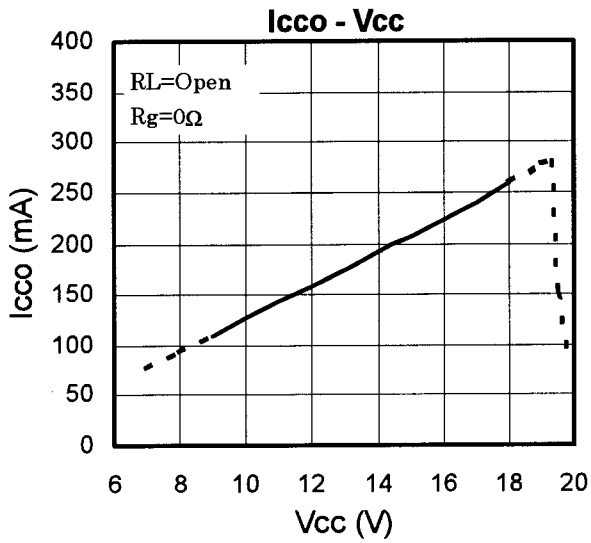

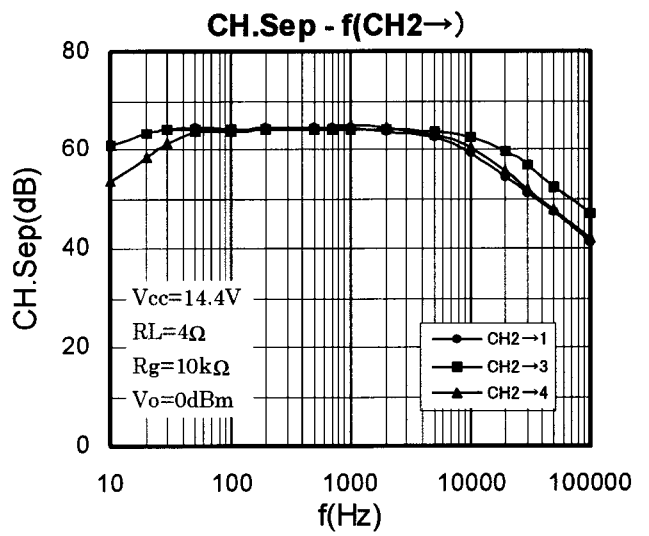
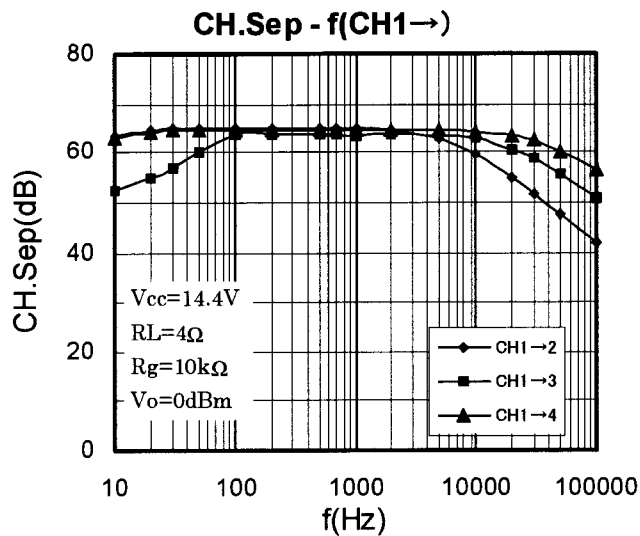
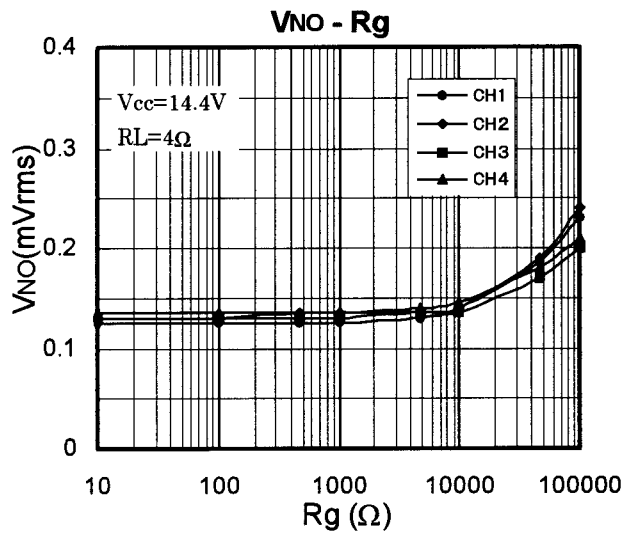
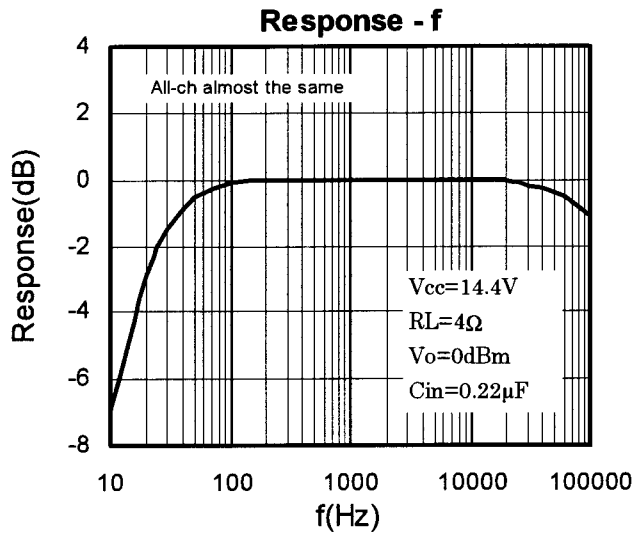
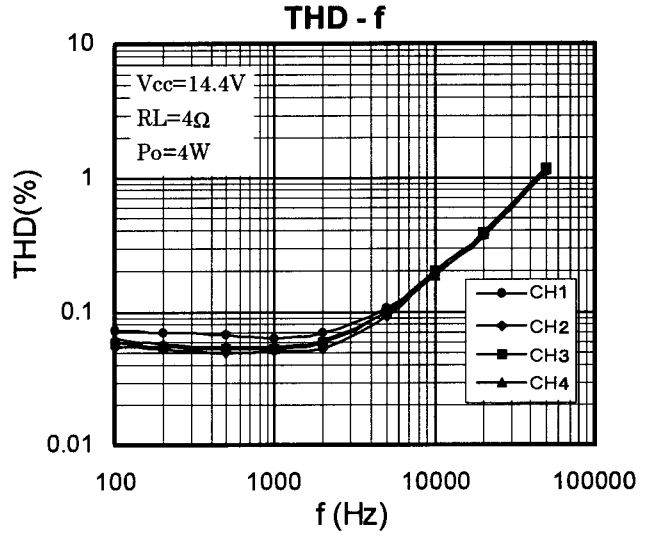
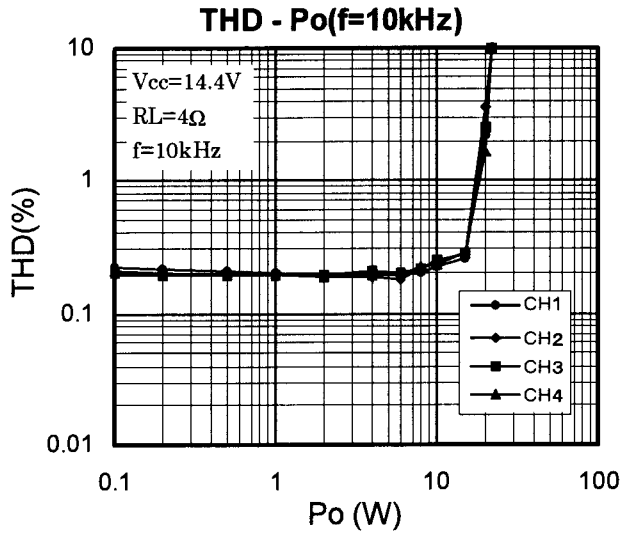

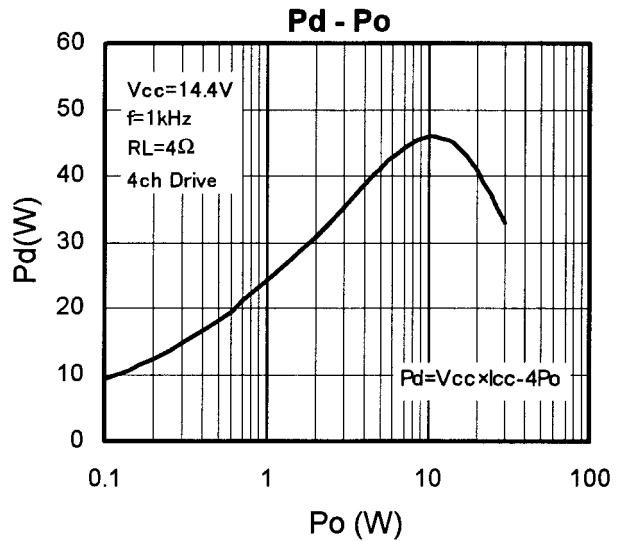
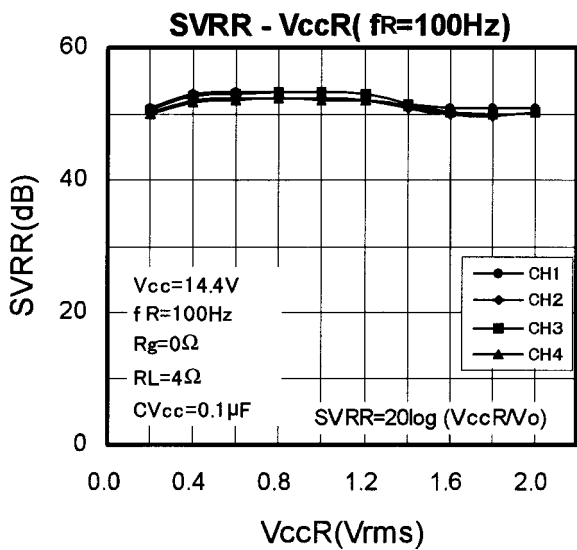
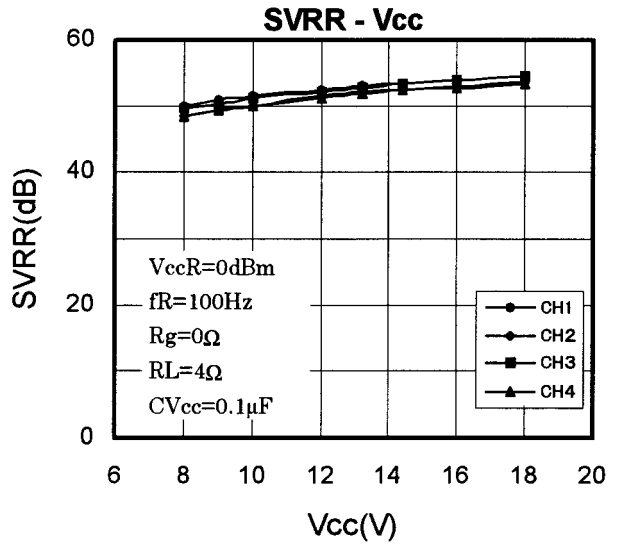
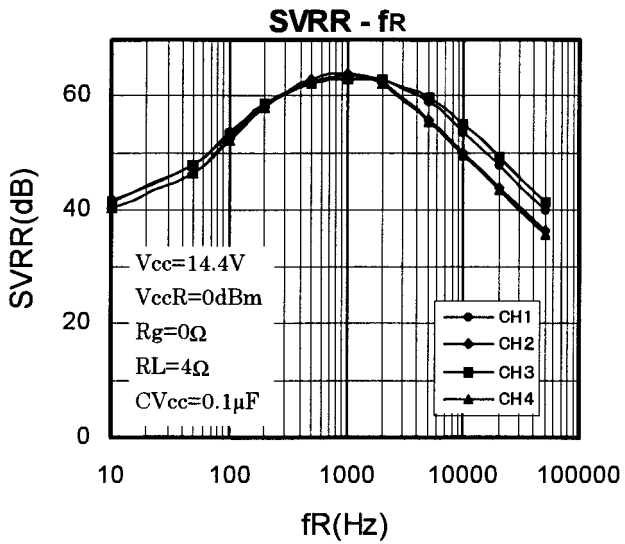
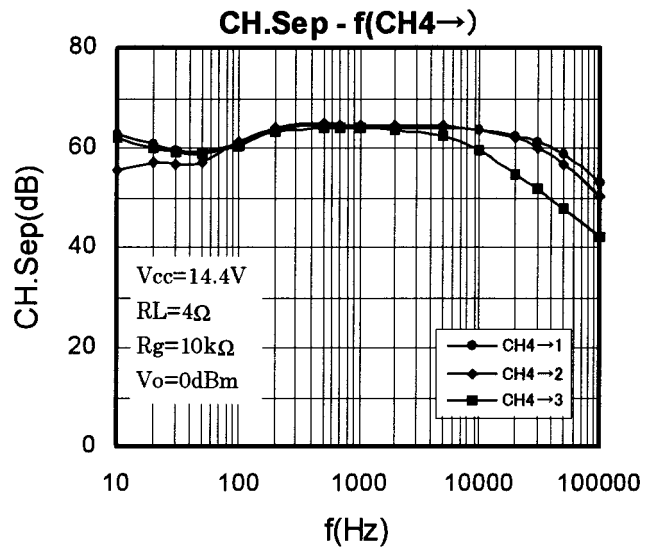
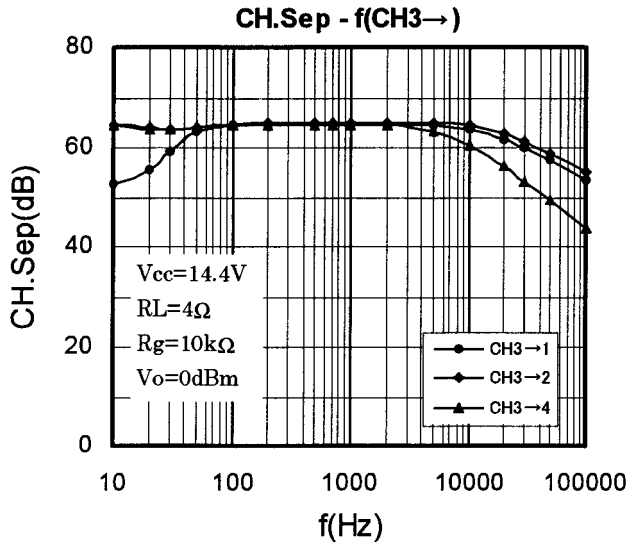

- Specifications of any and all SANYO products described or contained herein stipulate the performance, characteristics, and functions of the described products in the independent state, and are not guarantees of the performance, characteristics, and functions of the described products as mounted in the customer's products or equipment. To verify symptoms and states that cannot be evaluated in an independent device, the customer should always evaluate and test devices mounted in the customer's products or equipment.
- SANYO Electric Co., Ltd. strives to supply high-quality high-reliability products. However, any and all semiconductor products fail with some probability. It is possible that these probabilistic failures could give rise to accidents or events that could endanger human lives, that could give rise to smoke or fire, or that could cause damage to other property. When designing equipment, adopt safety measures so that these kinds of accidents or events cannot occur. Such measures include but are not limited to protective circuits and error prevention circuits for safe design, redundant design, and structural design.
- In the event that any or all SANYO products (including technical data, services) described or contained herein are controlled under any of applicable local export control laws and regulations, such products must not be exported without obtaining the export license from the authorities concerned in accordance with the above law.
- No part of this publication may be reproduced or transmitted in any form or by any means, electronic or mechanical, including photocopying and recording, or any information storage or retrieval system, or otherwise, without the prior written permission of SANYO Electric Co., Ltd.
- Any and all information described or contained herein are subject to change without notice due to product/technology improvement, etc. When designing equipment, refer to the "Delivery Specification" for the SANYO product that you intend to use.
- Information (including circuit diagrams and circuit parameters) herein is for example only ; it is not guaranteed for volume production. SANYO believes information herein is accurate and reliable, but no guarantees are made or implied regarding its use or any infringements of intellectual property rights or other rights of third parties.

This catalog provides information as of June, 2005. Specifications and information herein are subject to change without notice.