

## N-Channel Enhancement Mode MOSFET

### Features

- 30V/12A,  $R_{DS(ON)}=100m\Omega(max) @ V_{GS}=10V$   
 $R_{DS(ON)}=200m\Omega(max) @ V_{GS}=4.5V$
- Super High Dense Cell Design
- High Power and Current Handling Capability
- TO-252 and SOT-223 Packages

### Pin Description

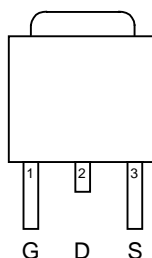

Top View of TO-252

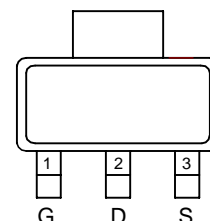

Top View of SOT-223

### Applications

- Switching Regulators
- Switching Converters

### Ordering and Marking Information

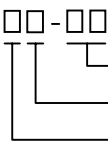
<p>APM3055L <span style="font-family: monospace;">□□-□□</span></p> <div style="margin-left: 20px;">  </div>	<p>Package Code                  U : TO-252    V : SOT-223                  Operation Junction Temp. Range                  C : -55 to 150° C                  Handling Code                  TR : Tape &amp; Reel</p>
<p>APM3055L U/V : <span style="border: 1px solid black; padding: 2px; font-family: monospace;">APM3055L XXXXX</span></p>	<p>XXXXX - Date Code</p>

### Absolute Maximum Ratings (T<sub>A</sub> = 25°C unless otherwise noted)

Symbol	Parameter	Rating	Unit
V <sub>DSS</sub>	Drain-Source Voltage	30	V
V <sub>GSS</sub>	Gate-Source Voltage	±20	
I <sub>D</sub>	Maximum Drain Current – Continuous	15	A
I <sub>DM</sub>	Maximum Drain Current – Pulsed	30	

ANPEC reserves the right to make changes to improve reliability or manufacturability without notice, and advise customers to obtain the latest version of relevant information to verify before placing orders.

**Absolute Maximum Ratings** ( $T_A = 25^\circ\text{C}$  unless otherwise noted)

Symbol	Parameter		Rating	Unit	
$P_D$	Maximum Power Dissipation	$T_A=25^\circ\text{C}$	TO-252	50	W
			SOT-223	3	
		$T_A=100^\circ\text{C}$	TO-252	20	
			SOT-223	1.2	
$T_J$	Maximum Junction Temperature		150	$^\circ\text{C}$	
$T_{STG}$	Storage Temperature Range		-55 to 150	$^\circ\text{C}$	

**Electrical Characteristics** ( $T_A = 25^\circ\text{C}$  unless otherwise noted)

Symbol	Parameter	Test Condition	APM3055L			Unit
			Min.	Typ.	Max.	
<b>Static</b>						
$BV_{DSS}$	Drain-Source Breakdown Voltage	$V_{GS}=0V, I_D=250\mu A$	30			V
$I_{DSS}$	Zero Gate Voltage Drain Current	$V_{DS}=24V, V_{GS}=0V$			1	$\mu A$
$V_{GS(th)}$	Gate Threshold Voltage	$V_{DS}=V_{GS}, I_D=250\mu A$	1		3	V
$I_{GSS}$	Gate Leakage Current	$V_{GS}=\pm 20V, V_{DS}=0V$			$\pm 100$	nA
$R_{DS(ON)}$	Drain-Source On-state Resistance	$V_{GS}=10V, I_D=12A$		75	100	m $\Omega$
		$V_{GS}=4.5V, I_D=6A$		100	200	
$V_{SD}$	Diode Forward Voltage	$I_S=6A, V_{GS}=0V$	0.6		1.3	V
<b>Dynamic</b>						
$Q_g$	Total Gate Charge	$V_{DS}=15V, V_{GS}=10V, I_D=2A$		8.5	12	nC
$Q_{gs}$	Gate-Source Charge			1.1		
$Q_{gd}$	Gate-Drain Charge			1.8		
$t_{ON}$	Turn-on Time	$V_{DD}=15V, I_D=2A, V_{GS}=10V, R_G=6\Omega$			40	ns
$t_{d(ON)}$	Turn-on Delay Time			11		
$t_r$	Turn-on Rise Time			17		
$t_{d(OFF)}$	Turn-off Delay Time			37		
$t_f$	Turn-off Fall Time			20		
$t_{OFF}$	Turn-off Time				60	

## Typical Characteristics

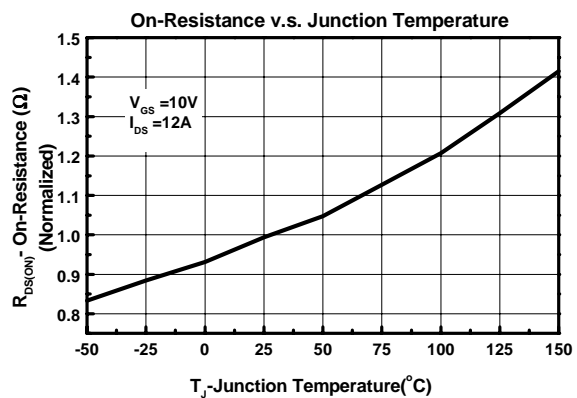
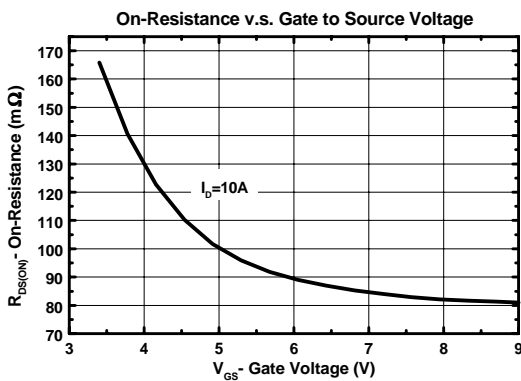
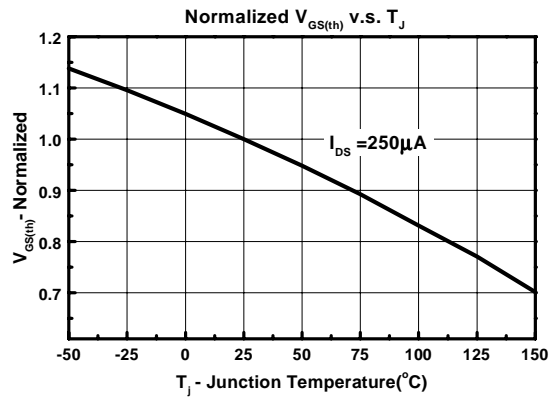
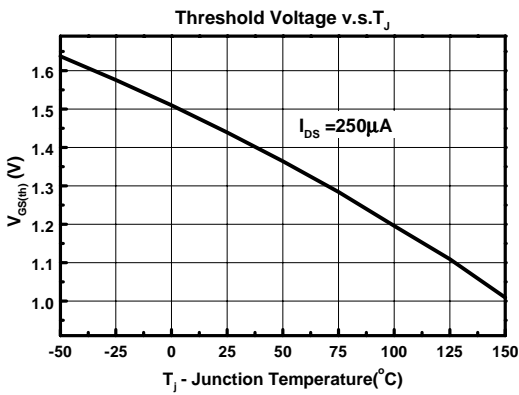
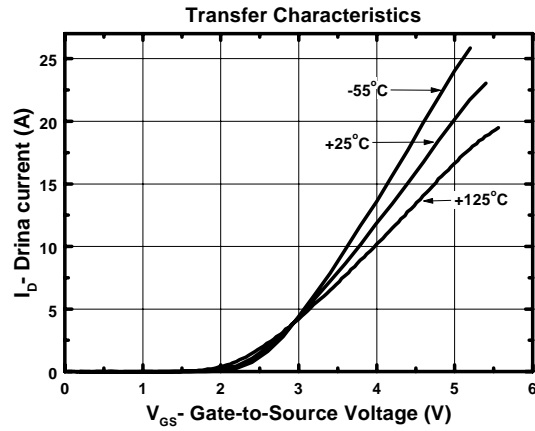
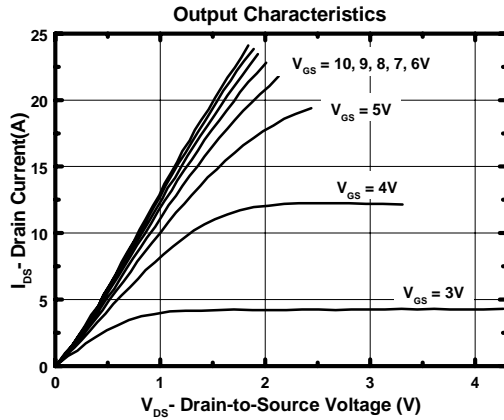

Typical Characteristics (Cont.)

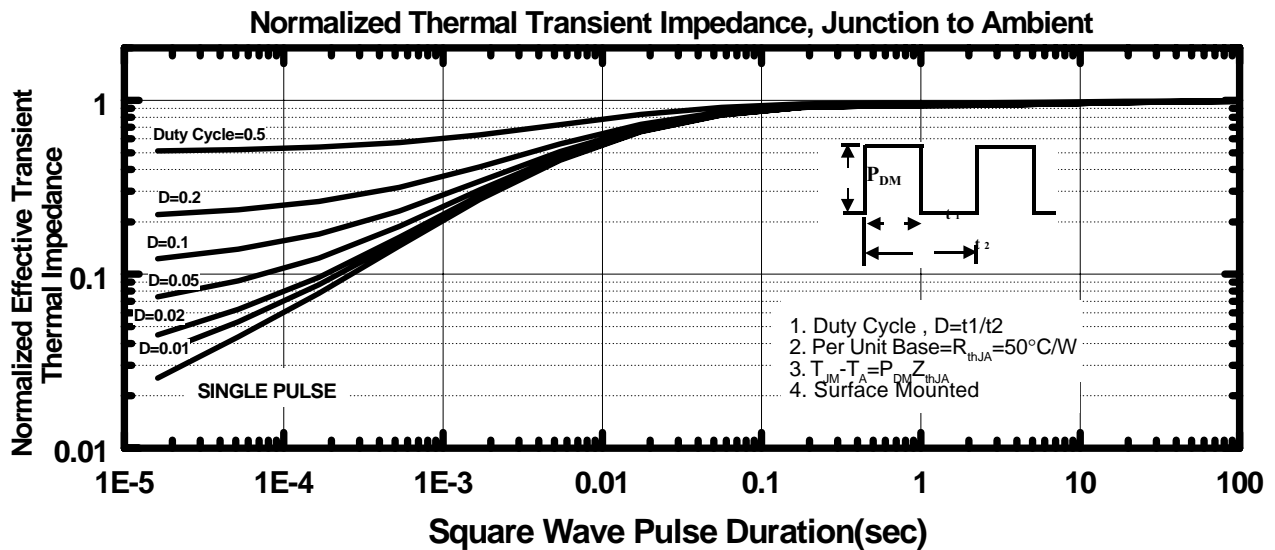
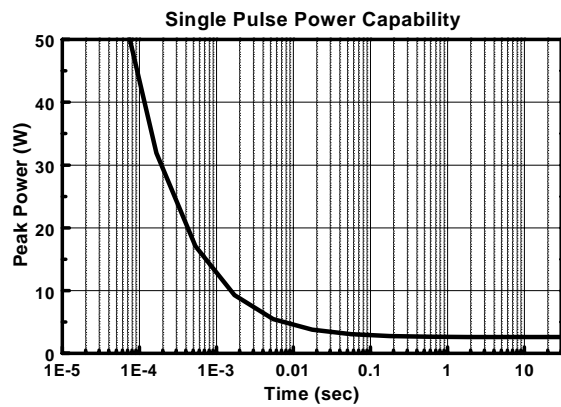
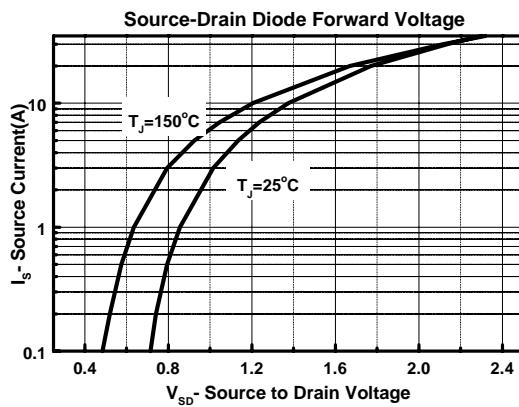
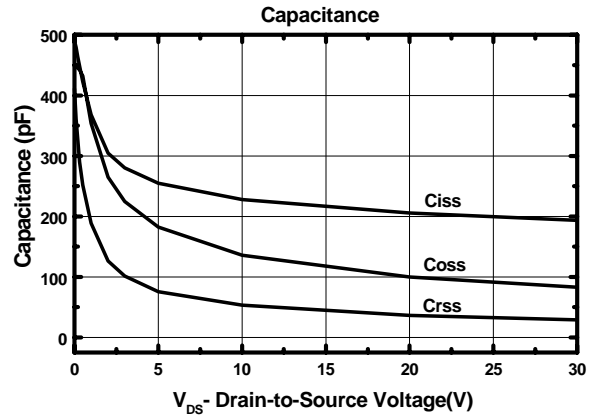
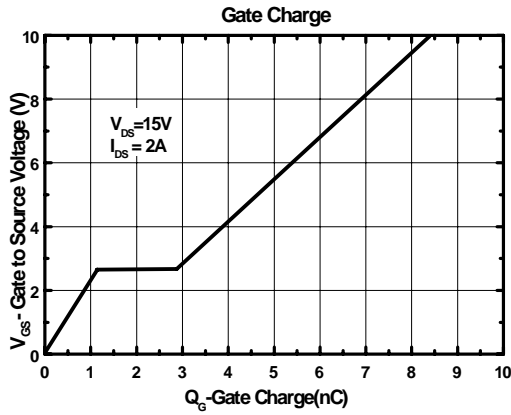

## Package Information

TO-252( Reference JEDEC Registration TO-252)

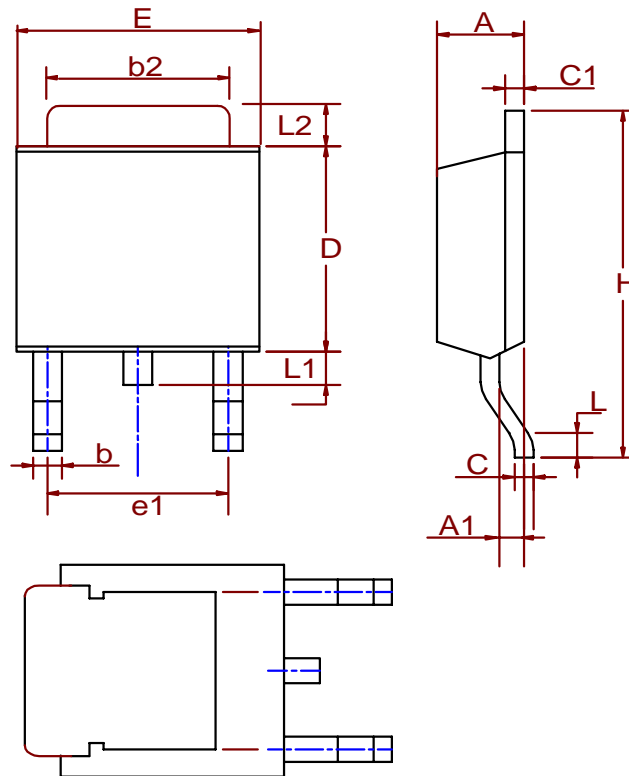

Dim	Millimeters		Inches	
	Min.	Max.	Min.	Max.
A	2.18	2.39	0.086	0.094
A1	0.89	1.27	0.035	0.050
b	0.508	0.89	0.020	0.035
b2	5.207	5.461	0.205	0.215
C	0.46	0.58	0.018	0.023
C1	0.46	0.58	0.018	0.023
D	5.334	6.22	0.210	0.245
E	6.35	6.73	0.250	0.265
e1	3.96	5.18	0.156	0.204
H	9.398	10.41	0.370	0.410
L	0.51		0.020	
L1	0.64	1.02	0.025	0.040
L2	0.89	2.032	0.035	0.080

## Package Information

SOT-223( Reference JEDEC Registration SOT-223)

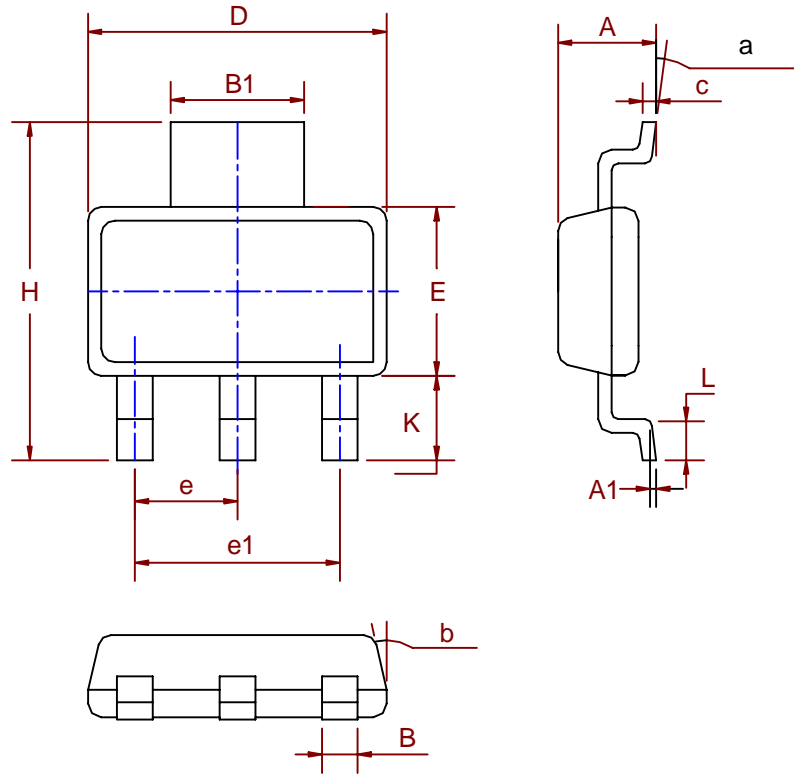

Dim	Millimeters		Inches	
	Min.	Max.	Min.	Max.
A	1.50	1.80	0.06	0.07
A1	0.02	0.08		
B	0.60	0.80	0.02	0.03
B1	2.90	3.10	0.11	0.12
c	0.28	0.32	0.01	0.01
D	6.30	6.70	0.25	0.26
E	3.30	3.70	0.13	0.15
e	2.3 BSC		0.09 BSC	
e1	4.6 BSC		0.18 BSC	
H	6.70	7.30	0.26	0.29
L	0.91	1.10	0.04	0.04
K	1.50	2.00	0.06	0.08
$\alpha$	0°	10°	0°	10°
$\beta$	13°		13°	

## Physical Specifications

Terminal Material	Solder-Plated Copper (Solder Material : 90/10 or 63/37 SnPb)
Lead Solderability	Meets EIA Specification RSI86-91, ANSI/J-STD-002 Category 3.

## Reflow Condition (IR/Convection or VPR Reflow)

Reference JEDEC Standard J-STD-020A APRIL 1999

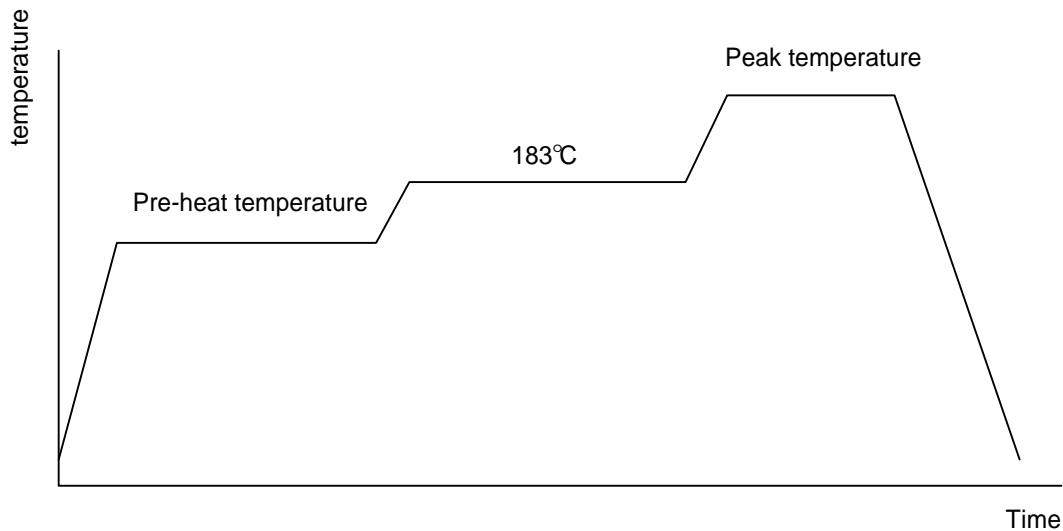

## Classification Reflow Profiles

	Convection or IR/ Convection	VPR
Average ramp-up rate(183°C to Peak)	3°C/second max.	10 °C /second max.
Preheat temperature 125 ± 25°C)	120 seconds max	
Temperature maintained above 183°C	60 – 150 seconds	
Time within 5°C of actual peak temperature	10 –20 seconds	60 seconds
Peak temperature range	220 +5/-0°C or 235 +5/-0°C	215-219°C or 235 +5/-0°C
Ramp-down rate	6 °C /second max.	10 °C /second max.
Time 25°C to peak temperature	6 minutes max.	

## Package Reflow Conditions

pkg. thickness ≥ 2.5mm and all bgas	pkg. thickness < 2.5mm and pkg. volume ≥ 350 mm <sup>3</sup>	pkg. thickness < 2.5mm and pkg. volume < 350mm <sup>3</sup>
Convection 220 +5/-0 °C		Convection 235 +5/-0 °C
VPR 215-219 °C		VPR 235 +5/-0 °C
IR/Convection 220 +5/-0 °C		IR/Convection 235 +5/-0 °C

### Reliability test program

Test item	Method	Description
SOLDERABILITY	MIL-STD-883D-2003	245°C , 5 SEC
HOLT	MIL-STD-883D-1005.7	1000 Hrs Bias @ 125 °C
PCT	JESD-22-B, A102	168 Hrs, 100 % RH , 121°C
TST	MIL-STD-883D-1011.9	-65°C ~ 150°C, 200 Cycles
ESD	MIL-STD-883D-3015.7	VHBM > 2KV, VMM > 200V
Latch-Up	JESD 78	10ms , I <sub>tr</sub> > 100mA

### Carrier Tape

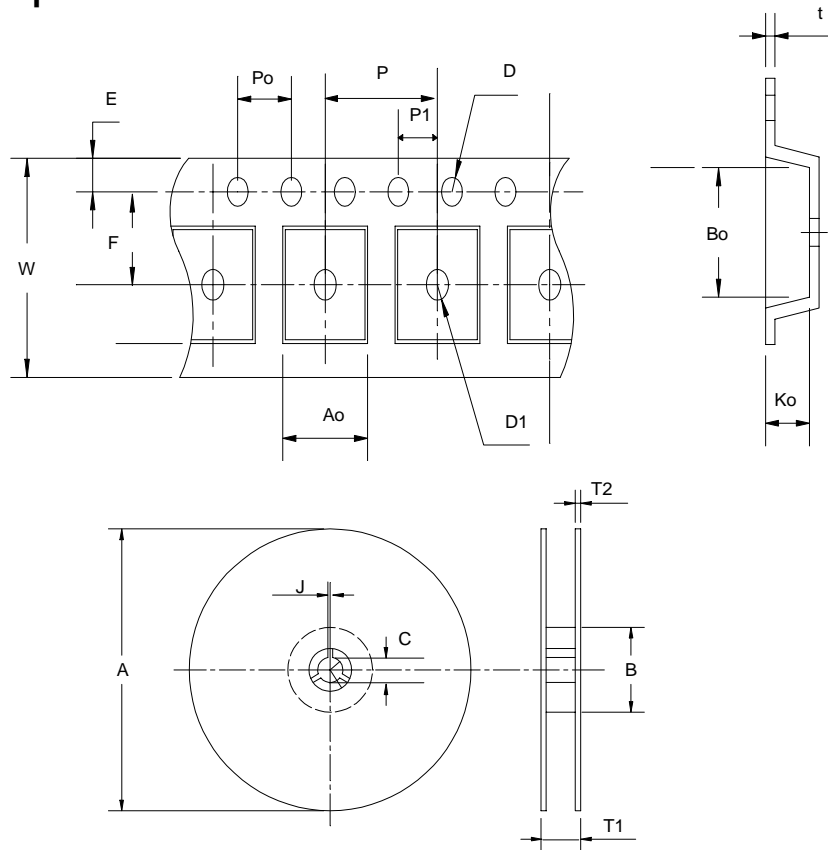

Application	A	B	C	J	T1	T2	W	P	E
TO-252	330 ±3	100 ±2	13 ±0.5	2 ±0.5	16.4 +0.3 -0.2	2.5 ±0.5	16+ 0.3 -0.1	8 ±0.1	1.75 ±0.1
	F	D	D1	Po	P1	Ao	Bo	Ko	t
	7.5 ±0.1	1.5 ±0.1	1.5 ±0.25	4.0 ±0.1	2.0 ±0.1	6.8 ±0.1	10.4 ±0.1	2.5 ±0.1	0.3 ±0.05
Application	A	B	C	J	T1	T2	W	P	E
SOT-223	330 ±1	62 ±1.5	12.75 ±0.15	2 ±0.6	12.4 +0.2	2 ±0.2	12 ±0.3	8 ±0.1	1.75 ±0.1
	F	D	D1	Po	P1	Ao	Bo	Ko	t
	5.5 ±0.05	1.5 ±0.1	1.5 ±0.1	4.0 ±0.1	2.0 ±0.05	6.9 ±0.1	7.5 ±0.1	2.1 ±0.1	0.3 ±0.05



## Cover Tape Dimensions

Application	Carrier Width	Cover Tape Width	Devices Per Reel
SOT- 223	12	9.3	2500
TO- 252	16	13.3	2500

## Customer Service

### **Anpec Electronics Corp.**

#### Head Office :

5F, No. 2 Li-Hsin Road, SBIP,

Hsin-Chu, Taiwan, R.O.C.

Tel : 886-3-5642000

Fax : 886-3-5642050

#### Taipei Branch :

7F, No. 137, Lane 235, Pac Chiao Rd.,

Hsin Tien City, Taipei Hsien, Taiwan, R. O. C.

Tel : 886-2-89191368

Fax : 886-2-89191369

This datasheet has been downloaded from:

[www.DatasheetCatalog.com](http://www.DatasheetCatalog.com)

Datasheets for electronic components.