

SHINDENGEN

Super Fast Recovery Rectifiers

Dual

D10LC20U

200V 10A

FEATURES

- Low noise
- trr35ns
- Fully Isolated Molding

APPLICATION

- Switching power supply
- Free Wheel
- Home Appliances, Office Equipment
- Telecommunication, Factory Automation

OUTLINE DIMENSIONS

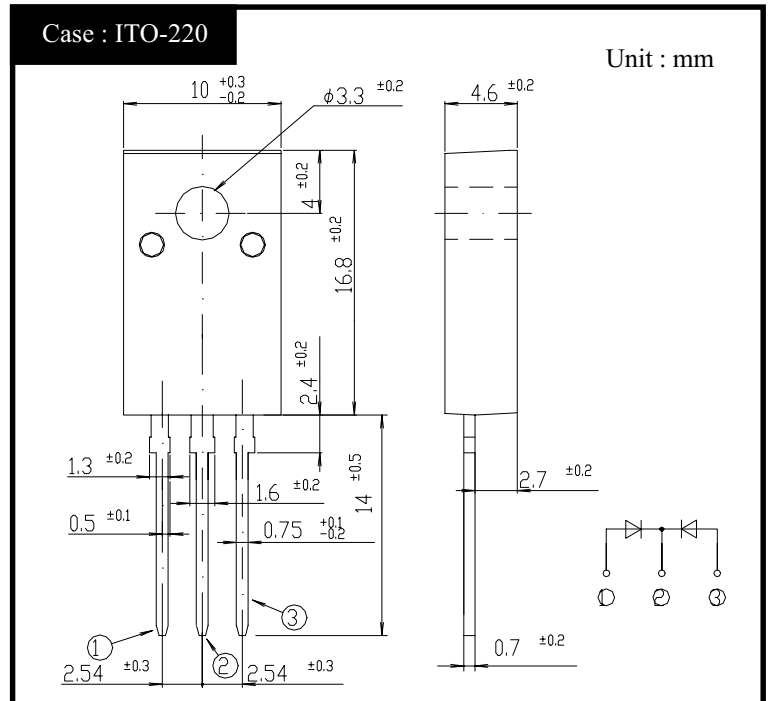

RATINGS

● Absolute Maximum Ratings (If not specified Tc=25°C)

Item	Symbol	Conditions	Ratings	Unit
Storage Temperature	T _{stg}		-40~150	°C
Operating Junction Temperature	T _j		150	°C
Maximum Reverse Voltage	V _{RM}		200	V
Average Rectified Forward Current	I _O	50Hz sine wave, R-load, Rating for each diode I _O /2, T _c =114°C	10	A
Peak Surge Forward Current	I _{FSM}	50Hz sine wave, Non-repetitive 1 cycle peak value, T _j =25°C	80	A
Dielectric Strength	V _{dis}	Terminals to case, AC 1 minute	1.5	kV
Mounting Torque	TOR	(Recommended torque: 0.3N·m)	0.5	N·m

● Electrical Characteristics (If not specified Tc=25°C)

Item	Symbol	Conditions	Ratings	Unit
Forward Voltage	V _F	I _F =5A, Pulse measurement, Rating of per diode	Max 0.98	V
Reverse Current	I _R	V _R =V _{RM} , Pulse measurement, Rating of per diode	Max 10	μA
Reverse Recovery Time	trr	I _F =0.5A, I _R =1A, Rating of per diode	Max 35	ns
Thermal Resistance	θ _{jc}	junction to case	Max 3.3	°C/W
	θ _{jf}	junction to heatsink (reference value)	Max 4.8	

D10LC20U Forward Voltage

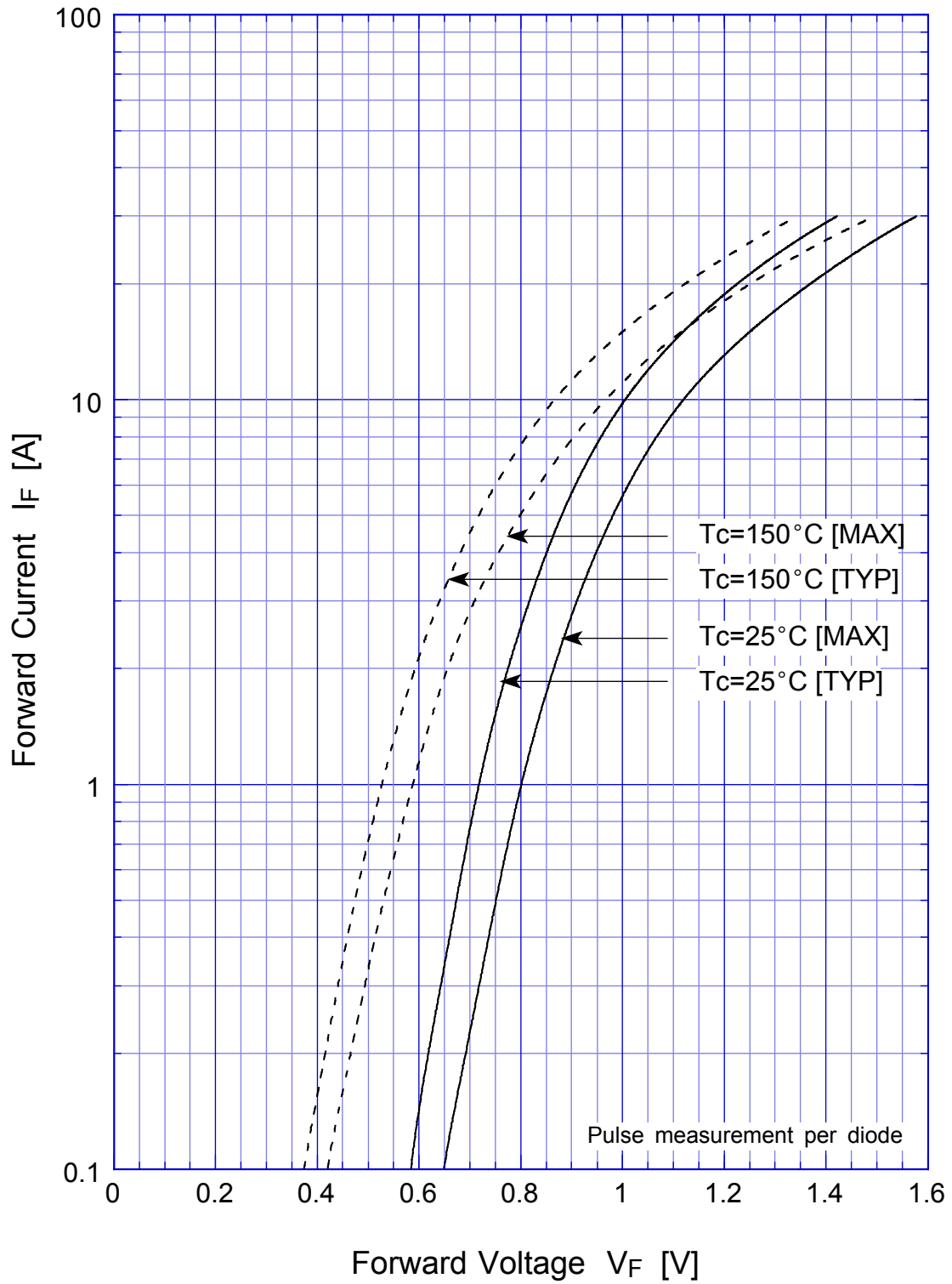

D10LC20U Forward Power Dissipation

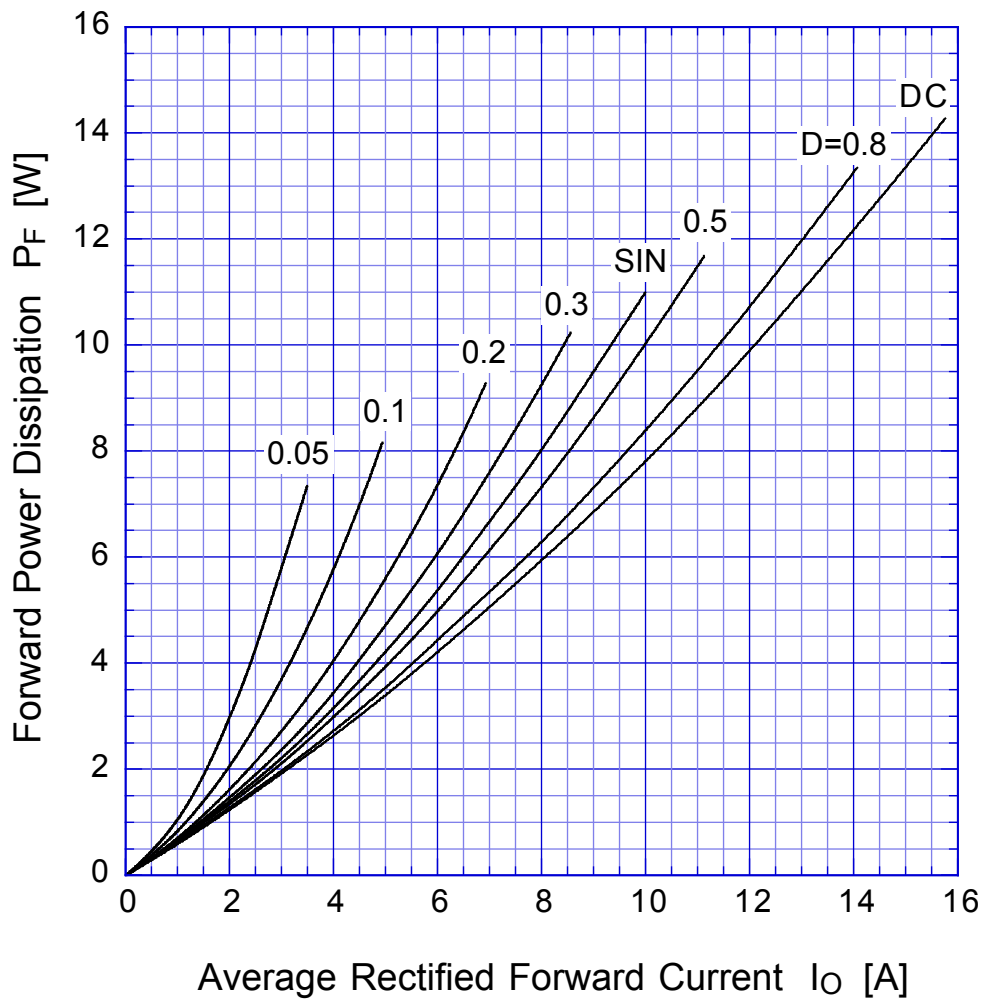

$T_j = T_{jmax}$

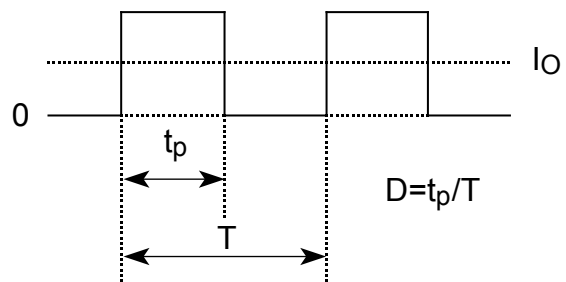

D10LC20U

Derating Curve

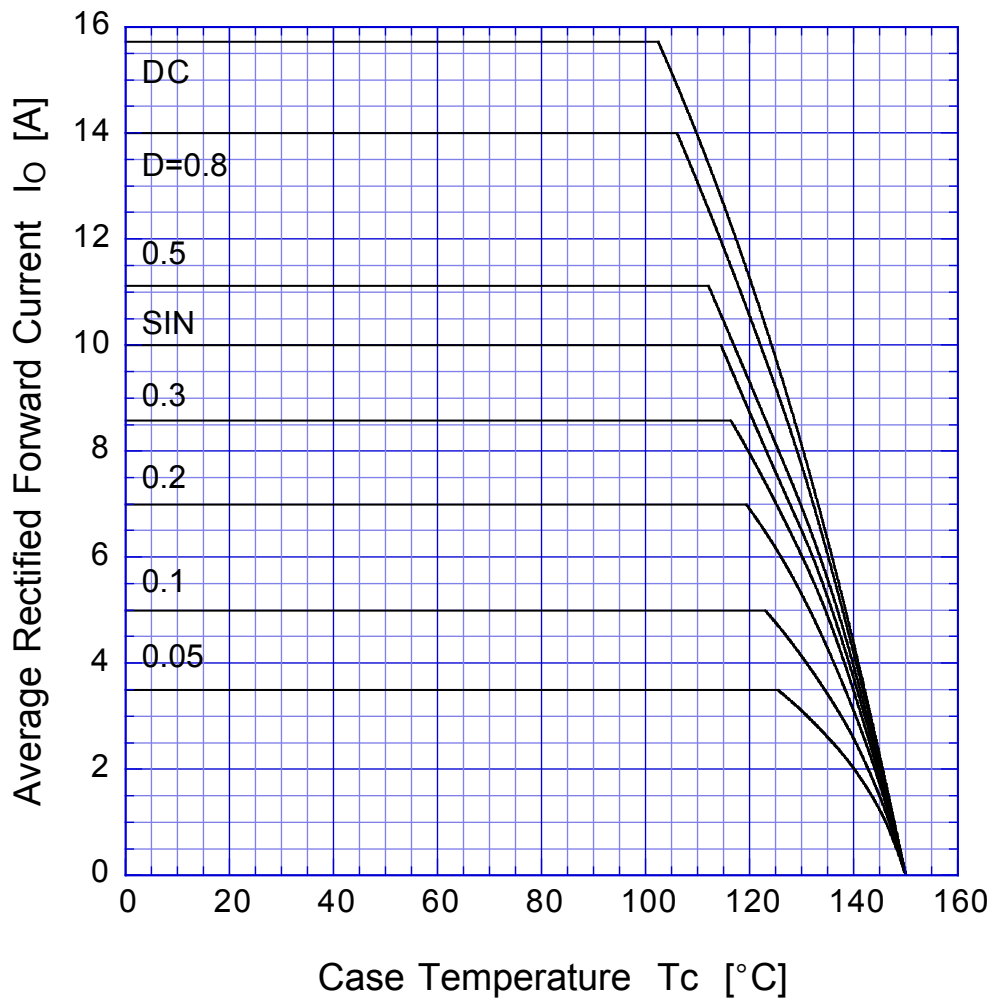

$$V_R = V_{RM}$$



D10LC20U Peak Surge Forward Capability

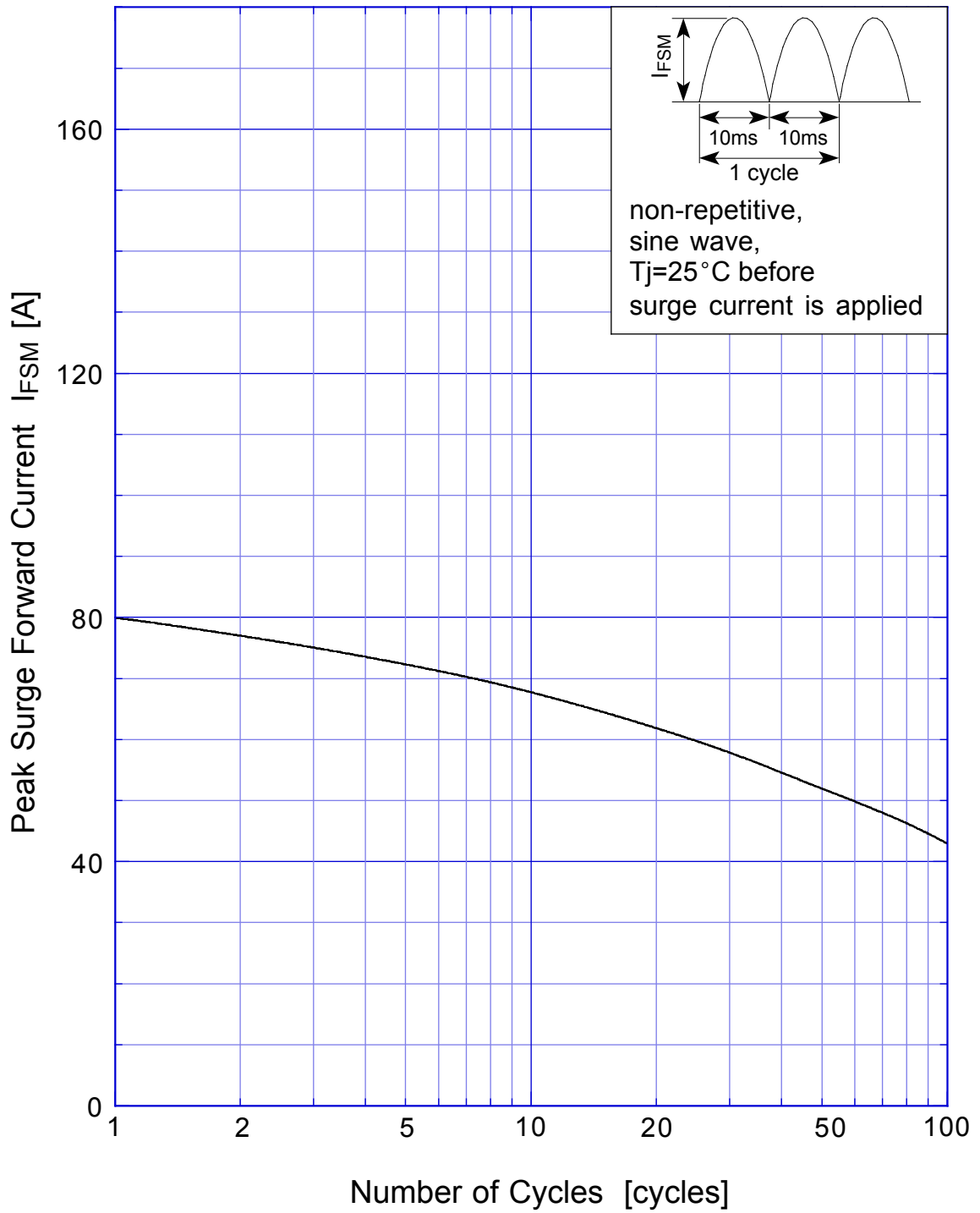

D10LC20U Junction Capacitance

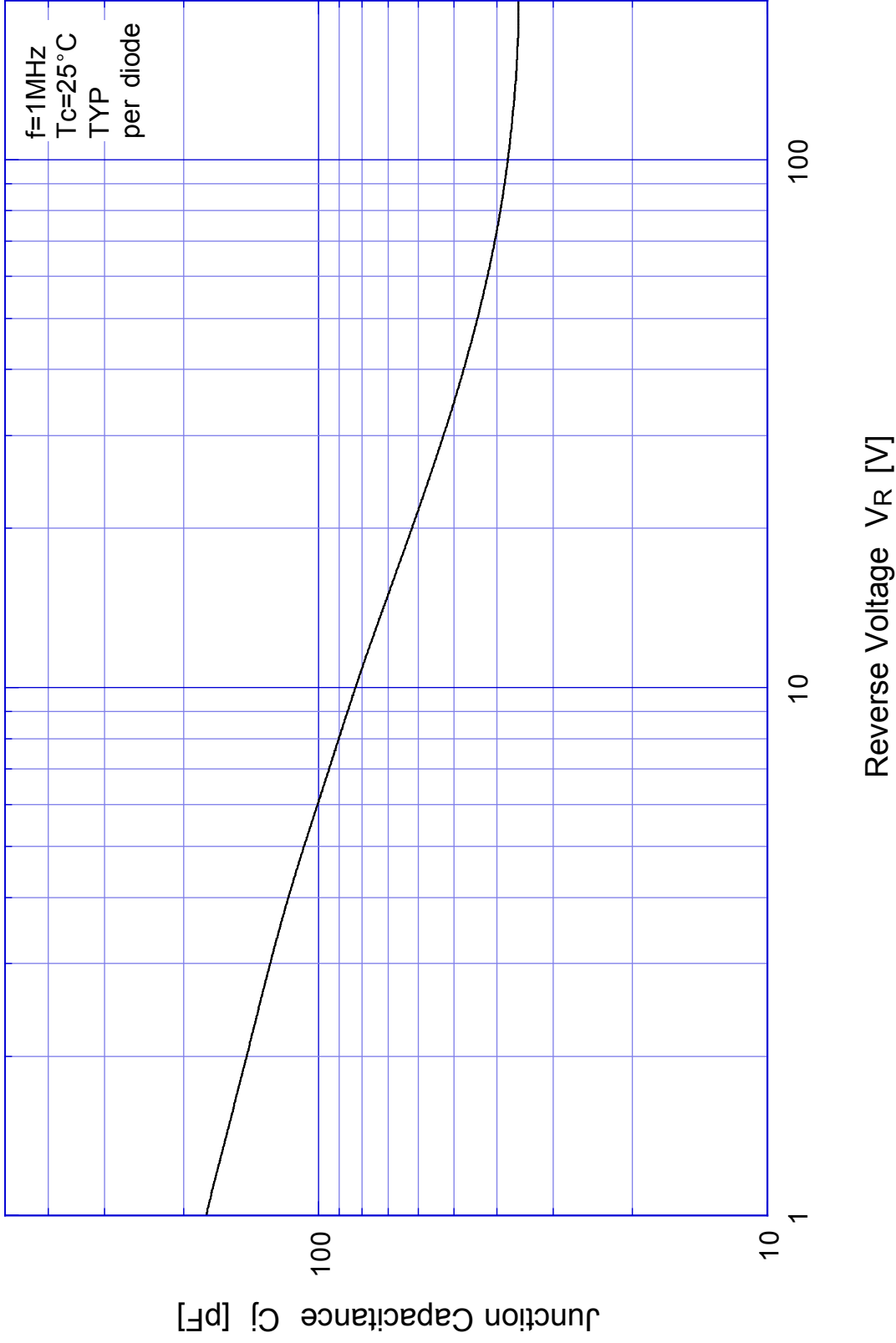

This datasheet has been download from:

www.datasheetcatalog.com

Datasheets for electronics components.