

KA5x02xx-SERIES

KA5H0265RC, KA5M0265R, KA5L0265R,
KA5H02659RN/KA5M02659RN, KA5H0280R,
KA5M0280R

Fairchild Power Switch(FPS)

Features

- Precision fixed operating frequency (100/67/50KHz)
- Pulse by pulse current limiting
- Over current protection
- Over voltage protection (Min. 25V)
- Internal thermal shutdown function
- Under voltage lockout
- Internal high voltage sense FET
- Auto-restart mode

Description

The Fairchild Power Switch(FPS) product family is specially designed for an off-line SMPS with minimal external components. The Fairchild Power Switch(FPS) consist of high voltage power SenseFET and current mode PWM IC. Included PWM controller features integrated fixed oscillator, under voltage lock out, leading edge blanking, optimized gate turn-on/turn-off driver, thermal shut down protection, over voltage protection, and temperature compensated precision current sources for loop compensation and fault protection circuitry. compared to discrete MOSFET and controller or RCC switching converter solution, a Fairchild Power Switch(FPS) can reduce total component count, design size, weight and at the same time increase efficiency, productivity, and system reliability. It has a basic platform well suited for cost-effective design in either a flyback converter or a forward converter.

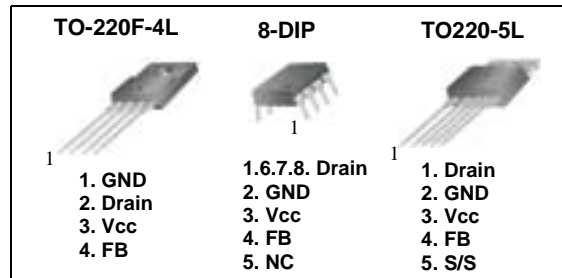

Internal Block Diagram

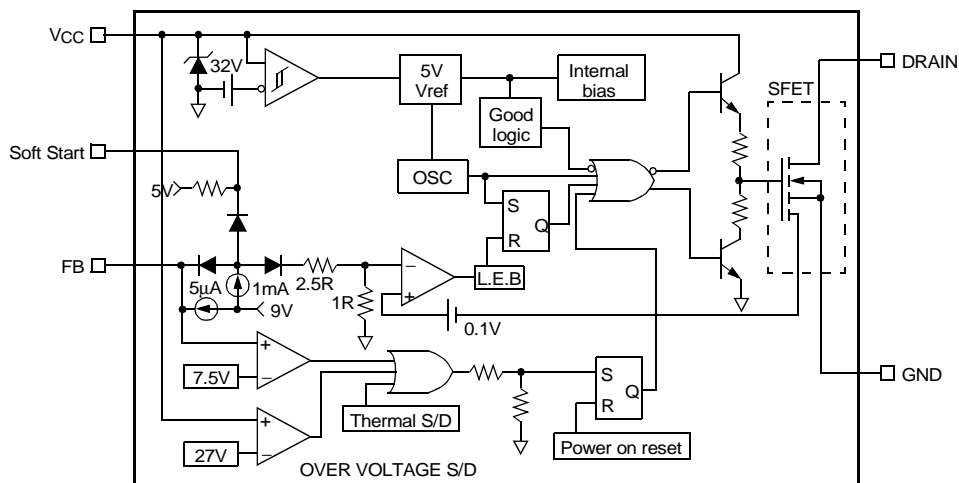

Absolute Maximum Ratings

(Ta=25°C, unless otherwise specified)

| Characteristic | Symbol | Value | Unit |
|--|---------------------|-------------------------|------|
| KA5x0265xRx | | | |
| Maximum Drain Voltage | V _{D,MAX} | 650 | V |
| Drain-Gate Voltage (R _{GS} =1MΩ) | V _{DGR} | 650 | V |
| Gate-Source (GND) Voltage | V _{GS} | ±30 | V |
| Drain Current Pulsed ⁽¹⁾ | I _{DM} | 8.0 | ADC |
| Continuous Drain Current (T _C =25°C) | I _D | 2.0 | ADC |
| Continuous Drain Current (T _C =100°C) | I _D | 1.3 | ADC |
| Single Pulsed Avalanche Energy ⁽²⁾ | E _{AS} | 68 | mJ |
| Maximum Supply Voltage | V _{CC,MAX} | 30 | V |
| Analog Input Voltage Range | V _{FB} | -0.3 to V _{SD} | V |
| Total Power Dissipation | P _D | 42 | W |
| | Derating | 0.33 | W/°C |
| Operating Junction Temperature. | T _J | +160 | °C |
| Operating Ambient Temperature. | T _A | -25 to +85 | °C |
| Storage Temperature Range. | T _{STG} | -55 to +150 | °C |
| KA5x0280R | | | |
| Maximum Drain Voltage | V _{D,MAX} | 800 | V |
| Drain-Gate Voltage (R _{GS} =1MΩ) | V _{DGR} | 800 | V |
| Gate-Source (GND) Voltage | V _{GS} | ±30 | V |
| Drain Current Pulsed ⁽¹⁾ | I _{DM} | 8.0 | ADC |
| Continuous Drain Current (T _C =25°C) | I _D | 2.0 | ADC |
| Continuous Drain Current (T _C =100°C) | I _D | 1.3 | ADC |
| Single Pulsed Avalanche Energy ⁽²⁾ | E _{AS} | 90 | mJ |
| Maximum Supply Voltage | V _{CC,MAX} | 30 | V |
| Analog Input Voltage Range | V _{FB} | -0.3 to V _{SD} | V |
| Total Power Dissipation | P _D | 35 | W |
| | Derating | 0.28 | W/°C |
| Operating Junction Temperature. | T _J | +160 | °C |
| Operating Ambient Temperature. | T _A | -25 to +85 | °C |
| Storage Temperature Range. | T _{STG} | -55 to +150 | °C |

Note:

1. Repetitive rating: Pulse width limited by maximum junction temperature
2. L=51mH, starting T_J=25°C

Electrical Characteristics (SFET part)

(Ta=25°C unless otherwise specified)

| Parameter | Symbol | Condition | Min. | Typ. | Max. | Unit |
|---|---------|---|------|------|------|------|
| KA5x0265xRx | | | | | | |
| Drain-source breakdown voltage | BVDSS | VGS=0V, ID=50μA | 650 | - | - | V |
| Zero gate voltage drain current | IDSS | VDS=Max. Rating, VGS=0V | - | - | 50 | μA |
| | | VDS=0.8Max. Rating, VGS=0V, TC=125°C | - | - | 200 | μA |
| Static drain-source on resistance ^(note) | RDS(ON) | VGS=10V, ID=0.5A | - | 5.0 | 6.0 | Ω |
| Forward transconductance ^(note) | gfs | VDS=50V, ID=0.5A | 1.5 | 2.5 | - | S |
| Input capacitance | Ciss | VGS=0V, VDS=25V, f=1MHz | - | 550 | - | pF |
| Output capacitance | Coss | | - | 38 | - | |
| Reverse transfer capacitance | Crss | | - | 17 | - | |
| Turn on delay time | td(on) | VDD=0.5BVDSS, ID=1.0A (MOSFET switching time are essentially independent of operating temperature) | - | 20 | - | nS |
| Rise time | tr | | - | 15 | - | |
| Turn off delay time | td(off) | | - | 55 | - | |
| Fall time | tf | | - | 25 | - | |
| Total gate charge (gate-source+gate-drain) | Qg | VGS=10V, ID=1.0A, VDS=0.5BVDSS (MOSFET switching time are essentially independent of operating temperature) | - | - | 35 | nC |
| Gate-source charge | Qgs | | - | 3 | - | |
| Gate-drain (Miller) charge | Qgd | | - | 12 | - | |
| KA5x0280R | | | | | | |
| Drain-source breakdown voltage | BVDSS | VGS=0V, ID=50μA | 800 | - | - | V |
| Zero gate voltage drain current | IDSS | VDS=Max. Rating, VGS=0V | - | - | 50 | μA |
| | | VDS=0.8Max. Rating, VGS=0V, TC=125°C | - | - | 200 | μA |
| Static drain-source on resistance ^(note) | RDS(ON) | VGS=10V, ID=0.5A | - | 5.6 | 7.0 | Ω |
| Forward transconductance ^(note) | gfs | VDS=50V, ID=0.5A | 1.5 | 2.5 | - | S |
| Input capacitance | Ciss | VGS=0V, VDS=25V, f=1MHz | - | 250 | - | pF |
| Output capacitance | Coss | | - | 52 | - | |
| Reverse transfer capacitance | Crss | | - | 25 | - | |
| Turn on delay time | td(on) | VDD=0.5BVDSS, ID=1.0A (MOSFET switching time are essentially independent of operating temperature) | - | 21 | - | nS |
| Rise time | tr | | - | 28 | - | |
| Turn off delay time | td(off) | | - | 77 | - | |
| Fall time | tf | | - | 24 | - | |
| Total gate charge (gate-source+gate-drain) | Qg | VGS=10V, ID=1.0A, VDS=0.5BVDSS (MOSFET switching time are essentially independent of operating temperature) | - | - | 60 | nC |
| Gate-source charge | Qgs | | - | 15 | - | |
| Gate-drain (Miller) charge | Qgd | | - | 20 | - | |

Note:

Pulse test: Pulse width ≤ 300μS, duty cycle ≤ 2%

$$S = \frac{1}{R}$$

Electrical Characteristics (CONTROL part)

(Ta=25°C unless otherwise specified)

| Parameter | Symbol | Condition | Min. | Typ. | Max. | Unit |
|---|----------------------|---|------|------|------|-------|
| UVLO SECTION | | | | | | |
| Start Threshold Voltage | V _{START} | V _{FB} =GND | 14 | 15 | 16 | V |
| Stop Threshold Voltage | V _{STOP} | V _{FB} =GND | 8.4 | 9 | 9.6 | V |
| OSCILLATOR SECTION | | | | | | |
| Initial accuracy | F _{OSC} | KA5H0265xRx KA5H0280R | 90 | 100 | 110 | kHz |
| Initial accuracy | F _{OSC} | KA5M0265xRx KA5M0280R | 61 | 67 | 73 | kHz |
| Initial accuracy | F _{OSC} | KA5L0265R | 45 | 50 | 55 | kHz |
| Frequency change with temperature ⁽²⁾ | ΔF/ΔT | -25°C ≤ Ta ≤ +85°C | - | ±5 | ±10 | % |
| Maximum duty cycle | D _{max} | KA5H0265xRx KA5H0280R | 62 | 67 | 72 | % |
| Maximum duty cycle | D _{max} | KA5M0265xRx KA5M0280R KA5L0265R | 72 | 77 | 82 | % |
| FEEDBACK SECTION | | | | | | |
| Feedback source current | I _{FB} | Ta=25°C, 0V ≤ V _{fb} ≤ 3V | 0.7 | 0.9 | 1.1 | mA |
| Shutdown feedback voltage | V _{SD} | V _{fb} ≤ 6.5V | 6.9 | 7.5 | 8.1 | V |
| Shutdown delay current | I _{delay} | Ta=25°C, 5V ≤ V _{fb} ≤ V _{SD} | 4 | 5 | 6 | μA |
| SOFT START SECTION | | | | | | |
| Soft Start Voltage | V _{SS} | KA5H0265RC | 4.7 | 5.0 | 5.3 | V |
| Soft Start Current | I _{SS} | | 0.8 | 1.0 | 1.2 | mA |
| REFERENCE SECTION | | | | | | |
| Output voltage ⁽¹⁾ | V _{ref} | Ta=25°C | 4.80 | 5.00 | 5.20 | V |
| Temperature Stability ⁽¹⁾⁽²⁾ | V _{ref} /ΔT | -25°C ≤ Ta ≤ +85°C | - | 0.3 | 0.6 | mV/°C |
| CURRENT LIMIT(SELF-PROTECTION)SECTION | | | | | | |
| Peak Current Limit | I _{OVER} | KA5x02659RN | 0.79 | 0.9 | 1.01 | A |
| Peak Current Limit | I _{OVER} | KA5x0265Rx KA5x0280R | 1.05 | 1.2 | 1.34 | A |
| PROTECTION SECTION | | | | | | |
| Over voltage protection | V _{OVP} | V _{CC} ≥ 24V | 25 | 27 | 29 | V |
| Thermal shutdown temperature (T _j) ⁽¹⁾ | T _{SD} | - | 140 | 160 | - | °C |
| TOTAL DEVICE SECTION | | | | | | |
| Start Up Current | I _{START} | V _{CC} =14V | - | 100 | 170 | μA |
| Operating supply current (control part only) | I _{OPR} | V _{CC} ≤ 28 | - | 7 | 12 | mA |

Note:

1. These parameters, although guaranteed, are not 100% tested in production
2. These parameters, although guaranteed, are tested in EDS (wafer test) process

Typical Performance Characteristics

(These characteristic graphs are normalized at $T_a=25^\circ\text{C}$)

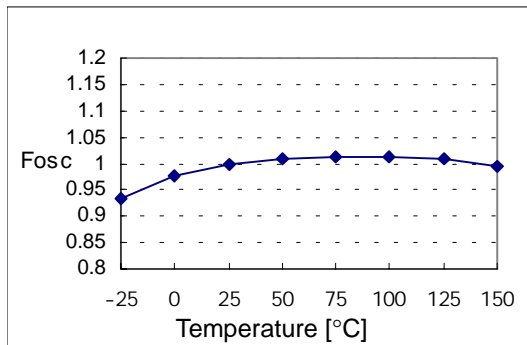

Figure 1. Operating Frequency

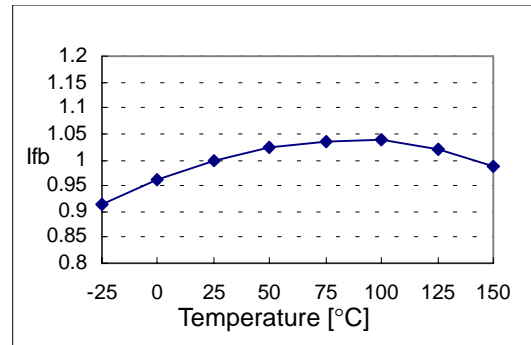

Figure 2. Feedback Source Current

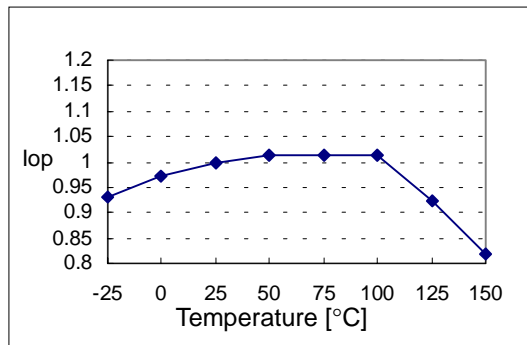

Figure 3. Operating Supply Current

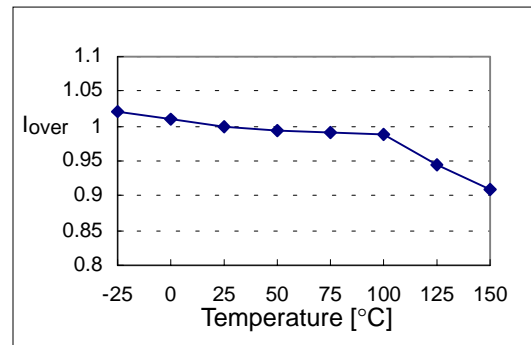

Figure 4. Peak Current Limit

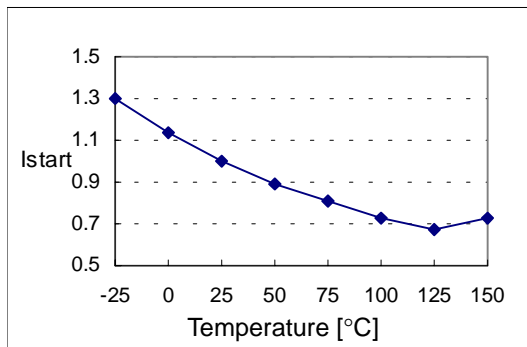

Figure 5. Start up Current

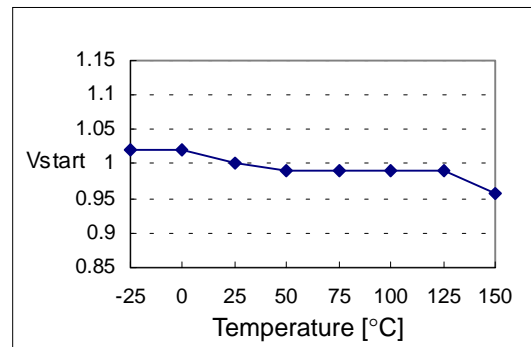

Figure 6. Start Threshold Voltage

Typical Performance Characteristics (Continued)

(These characteristic graphs are normalized at $T_a=25^\circ\text{C}$)

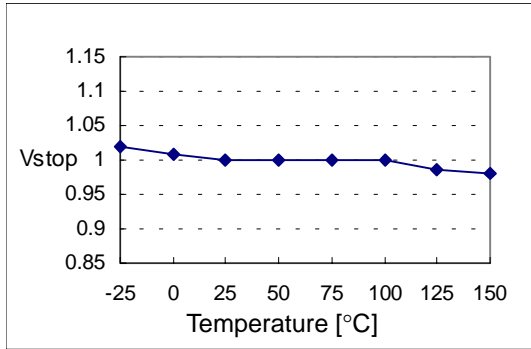

Figure 7. Stop Threshold Voltage

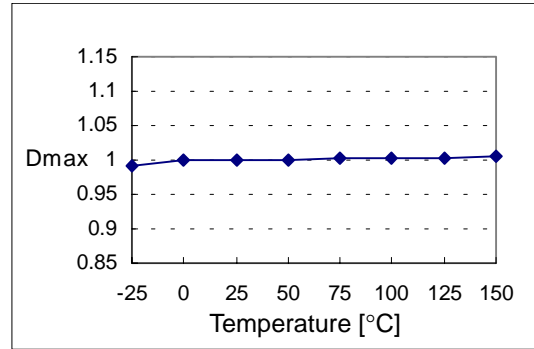

Figure 8. Maximum Duty Cycle

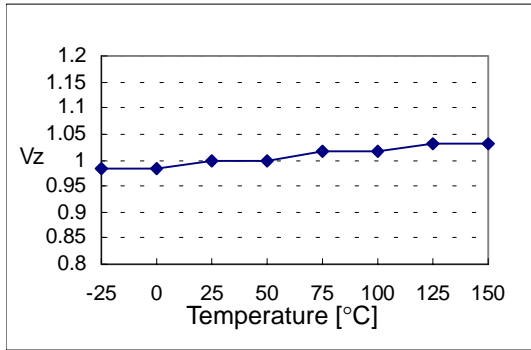

Figure 9. VCC Zener Voltage

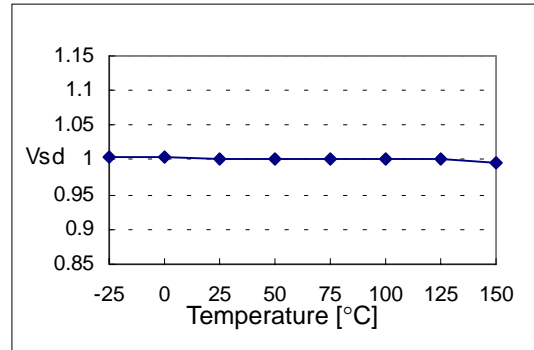

Figure 10. Shutdown Feedback Voltage

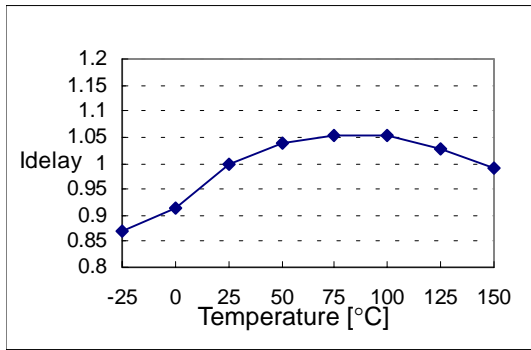

Figure 11. Shutdown Delay Current

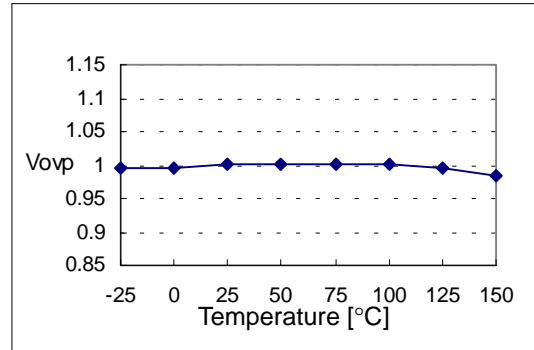

Figure 12. Over Voltage Protection

Typical Performance Characteristics (Continued)

(These characteristic graphs are normalized at $T_a=25^\circ\text{C}$)

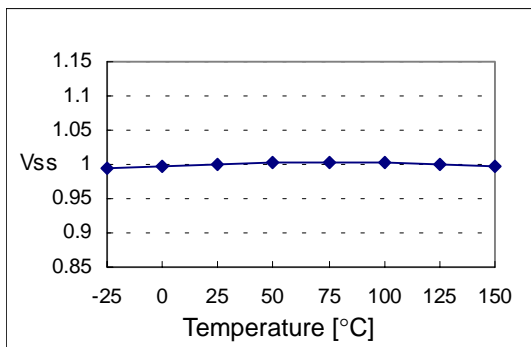

Figure13. Soft Start Voltage

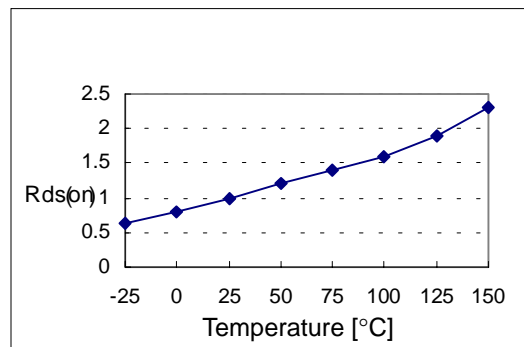
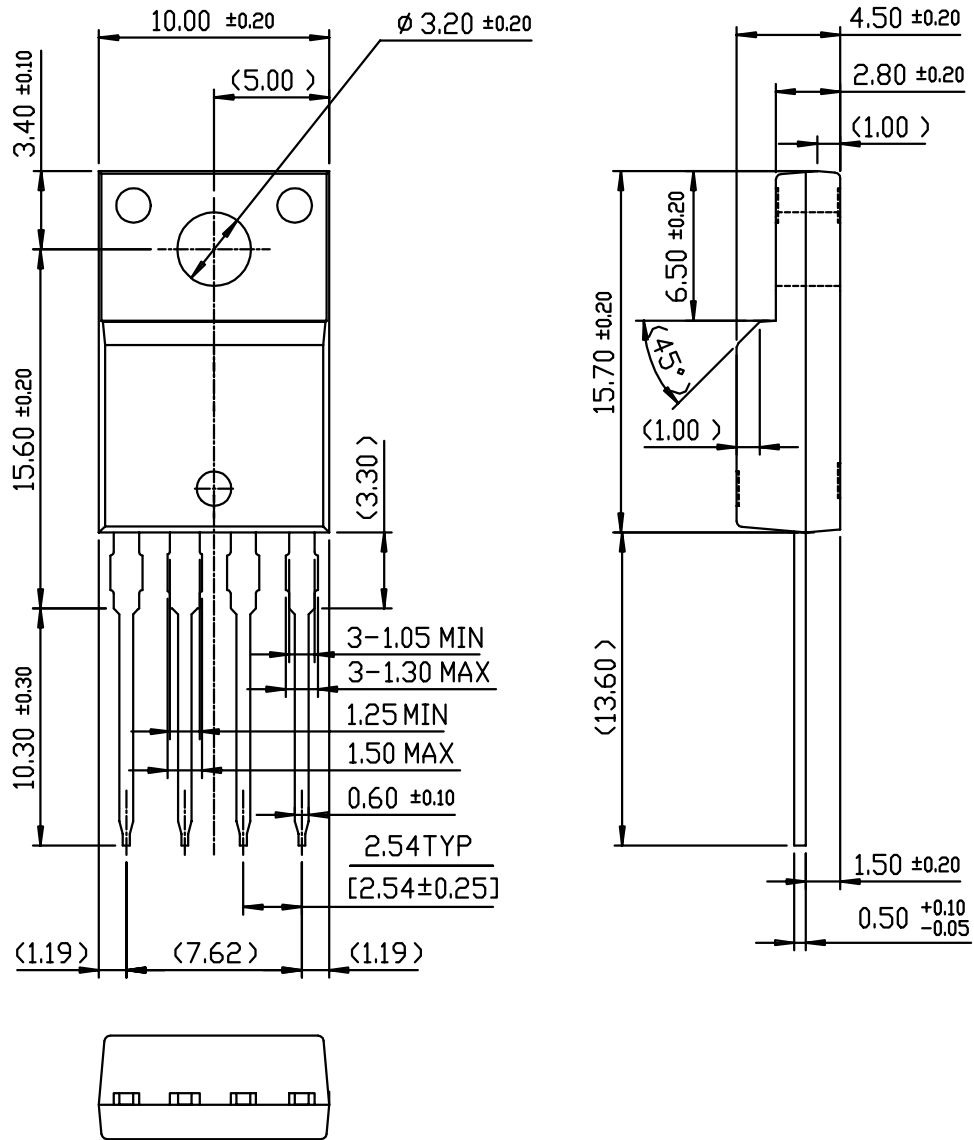

Figure 14. Static Drain-Source on Resistance

Package Dimensions

TO-220F-4L



Package Dimensions (Continued)

TO-220F-4L(Forming)

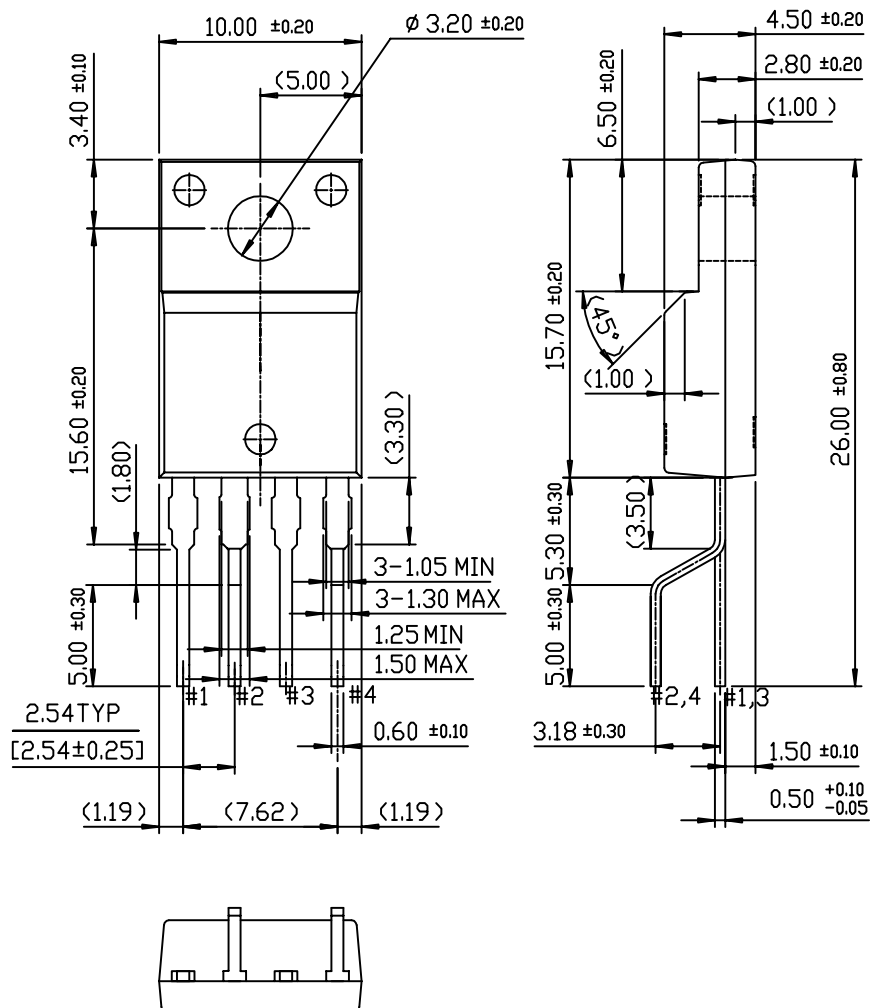

Package Dimensions (Continued)

8-DIP

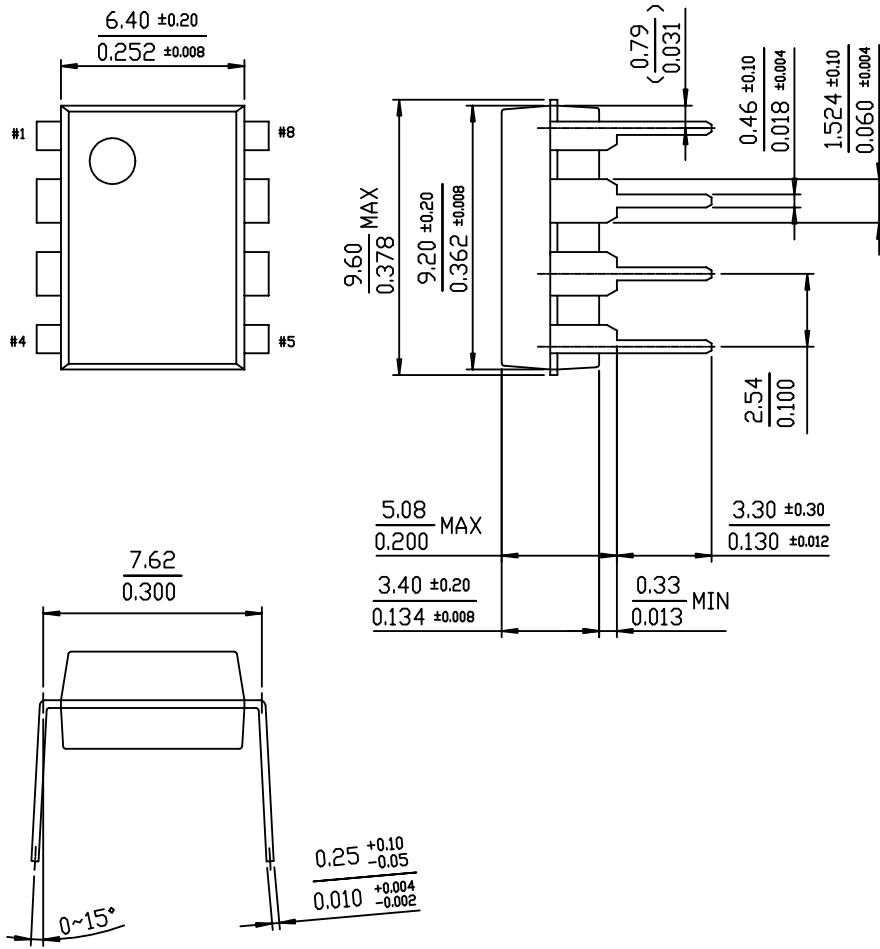

Package Dimensions (Continued)

TO-220-5L

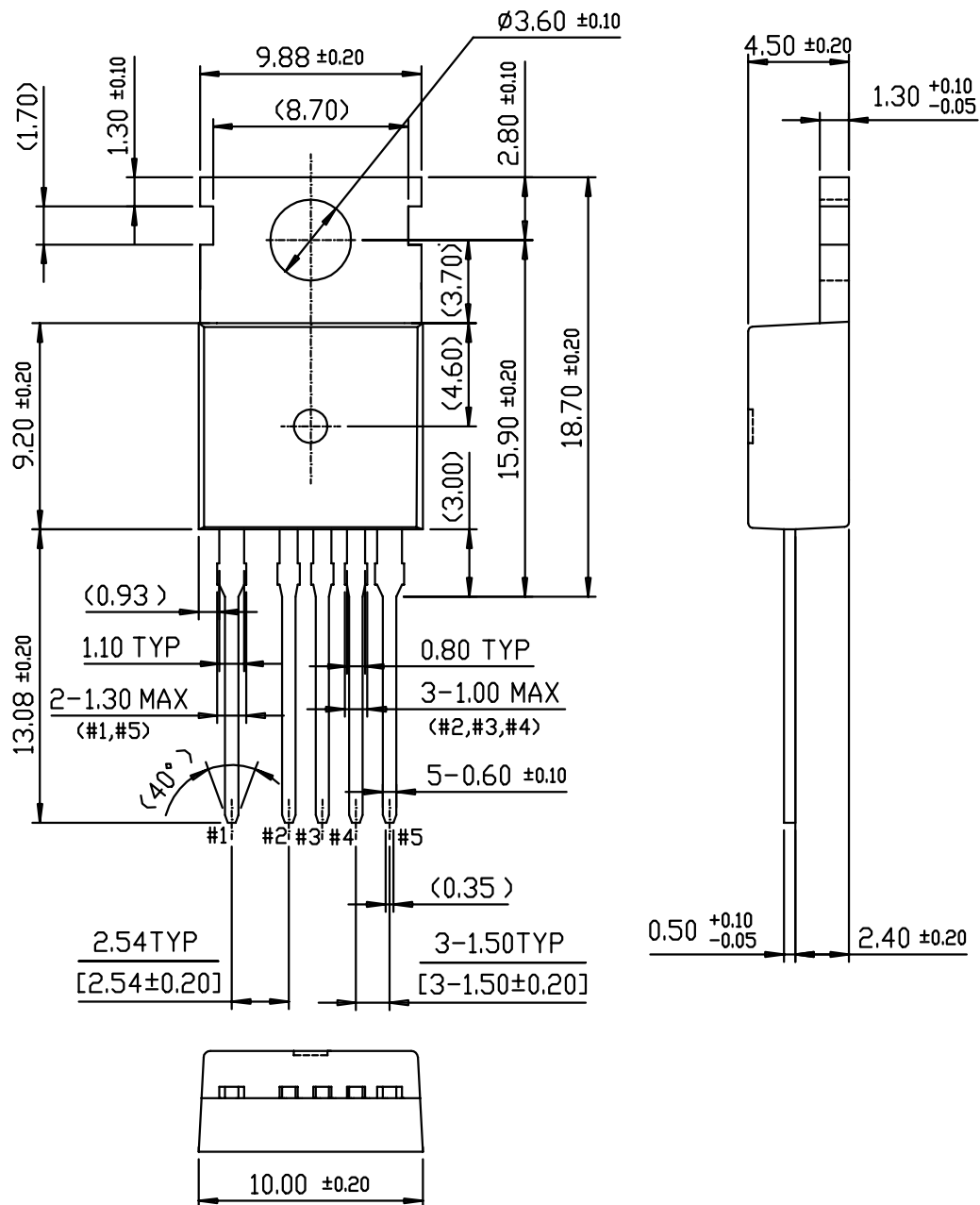

Package Dimensions (Continued)

TO-220-5L(Forming)

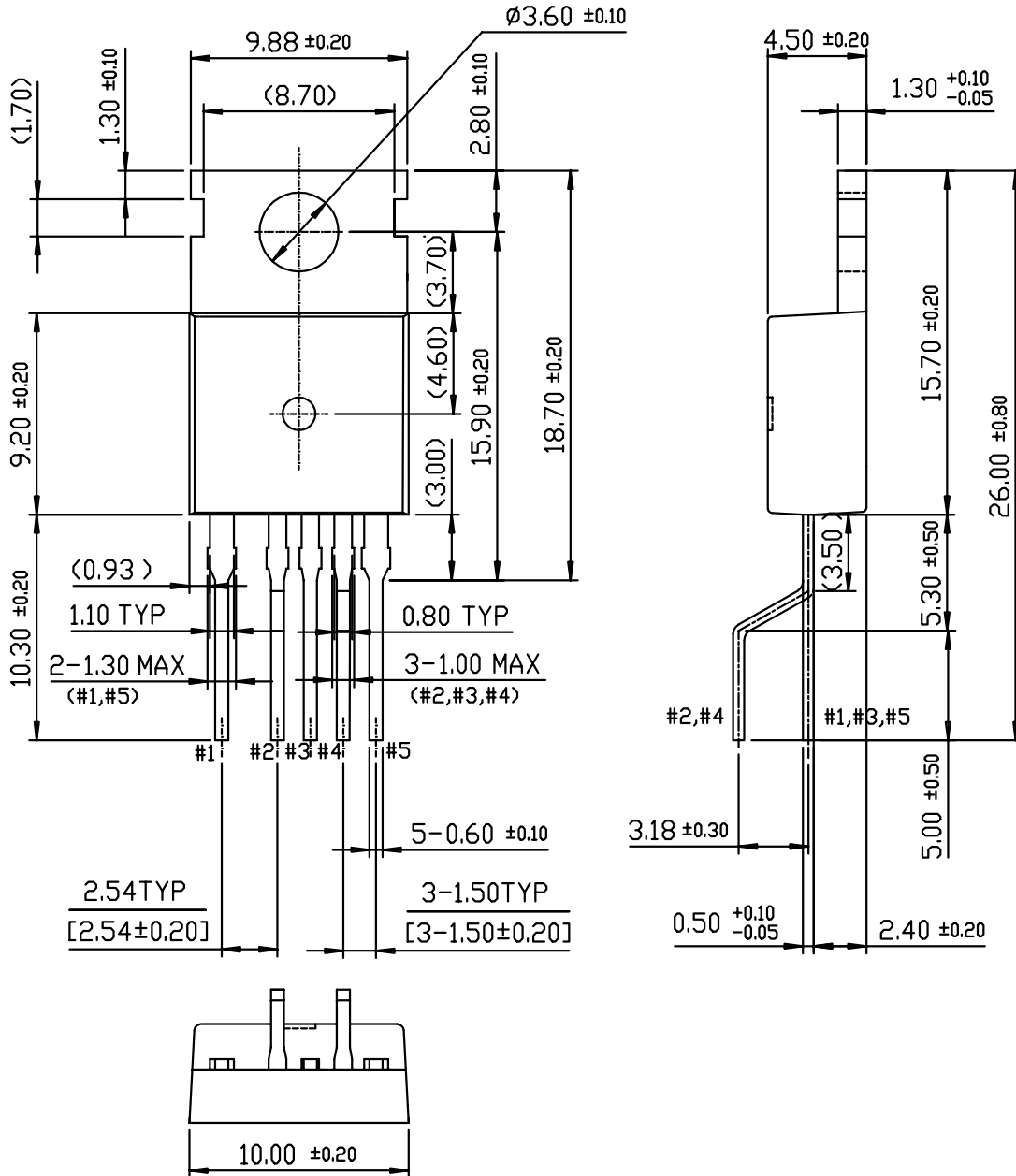

Ordering Information

| Product Number | Package | Marking Code | BV _{DSS} | FOSC | RDS(on) |
|-----------------|---------------------|--------------|-------------------|--------|---------|
| KA5H0265RC-TU | TO-220-5L | 5H0265RC | 650V | 100kHz | 5Ω |
| KA5H0265RC-YDTU | TO-220-5L(Forming) | | | | |
| KA5M0265R-TU | TO-220F-4L | 5M0265R | 650V | 67kHz | 5Ω |
| KA5M0265R-YDTU | TO-220F-4L(Forming) | | | | |
| KA5L0265R-TU | TO-220F-4L | 5L0265R | 650V | 50kHz | 5Ω |
| KA5L0265R-YDTU | TO-220F-4L(Forming) | | | | |

| Product Number | Package | Marking Code | BV _{DSS} | FOSC | RDS(on) |
|----------------|---------------------|--------------|-------------------|--------|---------|
| KA5H0280R-TU | TO-220F-4L | 5H0280R | 800V | 100kHz | 5.6Ω |
| KA5H0280R-YDTU | TO-220F-4L(Forming) | | | | |
| KA5M0280R-TU | TO-220F-4L | 5M0280R | 800V | 67kHz | 5.6Ω |
| KA5M0280R-YDTU | TO-220F-4L(Forming) | | | | |
| Product Number | Package | Marking Code | BV _{DSS} | FOSC | RDS(on) |
| KA5H02659RN | 8-DIP | 5H02659R | 650V | 100kHz | 5Ω |
| KA5M02659RN | 8-DIP | 5M02659R | 650V | 67kHz | 5Ω |

TU : Non Forming Type

YDTU : Forming Type

DISCLAIMER

FAIRCHILD SEMICONDUCTOR RESERVES THE RIGHT TO MAKE CHANGES WITHOUT FURTHER NOTICE TO ANY PRODUCTS HEREIN TO IMPROVE RELIABILITY, FUNCTION OR DESIGN. FAIRCHILD DOES NOT ASSUME ANY LIABILITY ARISING OUT OF THE APPLICATION OR USE OF ANY PRODUCT OR CIRCUIT DESCRIBED HEREIN; NEITHER DOES IT CONVEY ANY LICENSE UNDER ITS PATENT RIGHTS, NOR THE RIGHTS OF OTHERS.

LIFE SUPPORT POLICY

FAIRCHILD'S PRODUCTS ARE NOT AUTHORIZED FOR USE AS CRITICAL COMPONENTS IN LIFE SUPPORT DEVICES OR SYSTEMS WITHOUT THE EXPRESS WRITTEN APPROVAL OF THE PRESIDENT OF FAIRCHILD SEMICONDUCTOR CORPORATION. As used herein:

1. Life support devices or systems are devices or systems which, (a) are intended for surgical implant into the body, or (b) support or sustain life, and (c) whose failure to perform when properly used in accordance with instructions for use provided in the labeling, can be reasonably expected to result in a significant injury of the user.
2. A critical component in any component of a life support device or system whose failure to perform can be reasonably expected to cause the failure of the life support device or system, or to affect its safety or effectiveness.

This datasheet has been download from:

www.datasheetcatalog.com

Datasheets for electronics components.