

**50 to 80 W POWER AMPLIFIER DRIVER**

**DESCRIPTION**

$\mu$ PC1298V is a integrated monolithic circuit designed for 50 W to 80 W class HiFi audio power amplifier and consists of a input differential amplifier, a predriver circuit, a driver circuit and a over current protection circuit.

**FEATURES**

- Low Distortion.  
0.002 % TYP. ( $V_{CC} = \pm 46$  V,  $f = 1$  kHz,  $A_v = 30$  dB,  $P_O = 50$  W,  $R_L = 8 \Omega$  with Power Transistor)  
0.006 % TYP. ( $V_{CC} = \pm 46$  V,  $f = 20$  kHz,  $A_v = 30$  dB,  $P_O = 50$  W,  $R_L = 8 \Omega$  with Power Transistor)
- Wide Frequency Band.  
900 kHz TYP. (-3 dB)
- Wide Power Band Width.  
90 kHz TYP. ( $P_O = 40$  W, THD = 0.1 %)

**BLOCK DIAGRAM**

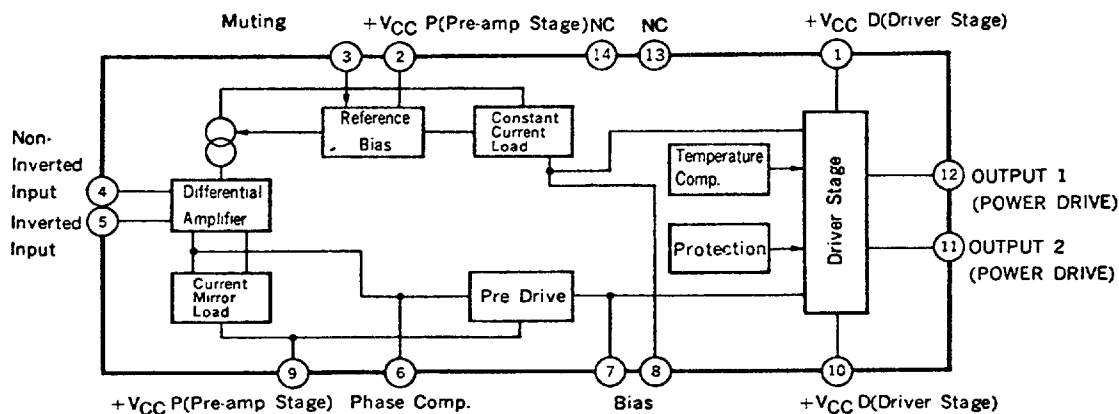

**NOTE:** The built-in over current circuit protects  $\mu$ PC1298V and cannot protect external power transistors.

NEC cannot assume any responsibility for any circuits shown or represent that they are free from patent infringement.

**ABSOLUTE MAXIMUM RATINGS (T<sub>a</sub> = 25 °C)**

Supply Voltage (Quiescent)	V <sub>CC1</sub>	±65	V
Supply Voltage (Operational)	V <sub>CC2</sub>	±60	V
Circuit Current	I <sub>CC(peak)</sub>	250	mA
Allowable Package Dissipation	P <sub>D</sub>	7.5*	W
Operational Temperature	T <sub>opt</sub>	-20 to +75	°C
Storage Temperature	T <sub>stg</sub>	-40 to +150	°C

\* 100 x 100 x 2 mm Al heat sink

**RECOMMENDED OPERATING CONDITION**

Supply Voltage (Operational)	V <sub>CC</sub> = ±20 to ±46 V
Input Bias Resistance	R <sub>IN</sub> = 1 to 50 to 100 kΩ
Power Transistor h <sub>FE</sub>	h <sub>FE</sub> ≥ 50 at P <sub>O</sub> = 80 W, R <sub>L</sub> = 8 Ω, T <sub>j</sub> < 125 °C
Closed Loop Voltage Gain	A <sub>v</sub> = 26 to 30 dB
Junction Temperature	T <sub>j</sub> = -20 to 125 °C

**ELECTRICAL CHARACTERISTICS (V<sub>CC</sub> = ±46 V, A<sub>v</sub> = 30 dB, Use Standard Test Circuit, T<sub>a</sub> = 25 °C)**

CHARACTERISTIC	SYMBOL	MIN.	TYP.	MAX.	UNIT	CONDITION
Output Offset Voltage	V <sub>offset</sub>		±5	±50	mV	V <sub>IN</sub> = 0
Quiescent Circuit Current	I <sub>CC</sub>		20	40	mA	V <sub>IN</sub> = 0
Maximum Output Voltage	V <sub>OM</sub>	25	28		V	THD=0.05%, f=20 Hz to 20 kHz
Open Loop Voltage Gain	A <sub>vo</sub>	80	95		dB	V <sub>O</sub> = 1.5 V, f = 1 kHz
Output Noise Voltage	V <sub>n</sub>		0.07	0.14	mV	R <sub>G</sub> = 10 kΩ
Rolloff Frequency	f <sub>H</sub>		900		kHz	V <sub>O</sub> = 1.5 V, -3 dB
Supply Voltage Rejection Ratio	SVR	55	70		dB	R <sub>G</sub> = 2.2 kΩ, f <sub>ripple</sub> = 100 Hz, v <sub>ripple</sub> = 1 V <sub>r.m.s.</sub>

**EQUIVALENT CIRCUIT**

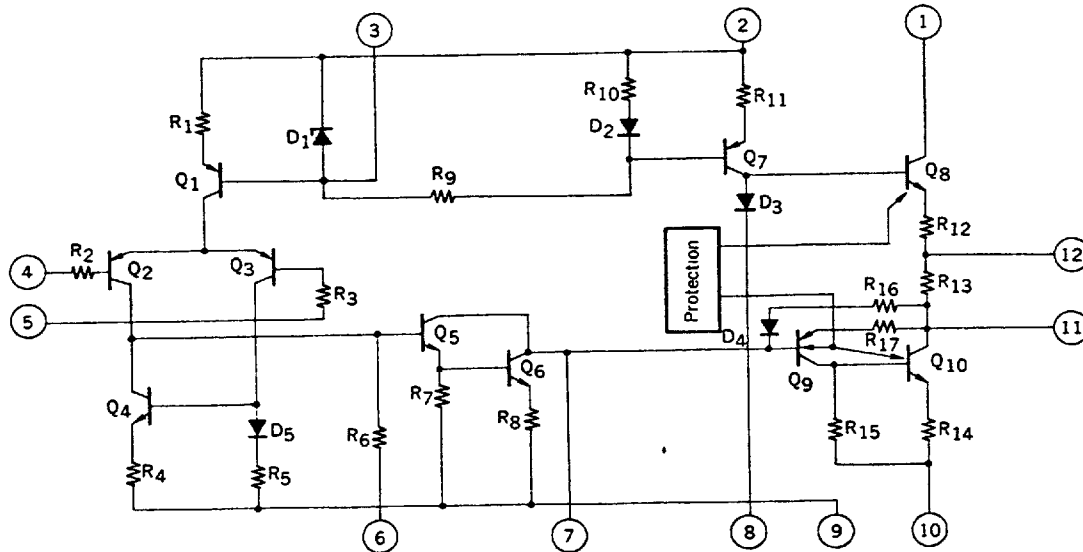

TEST CIRCUIT 1 ( $I_{CC}$ ,  $V_{OFF}$ )

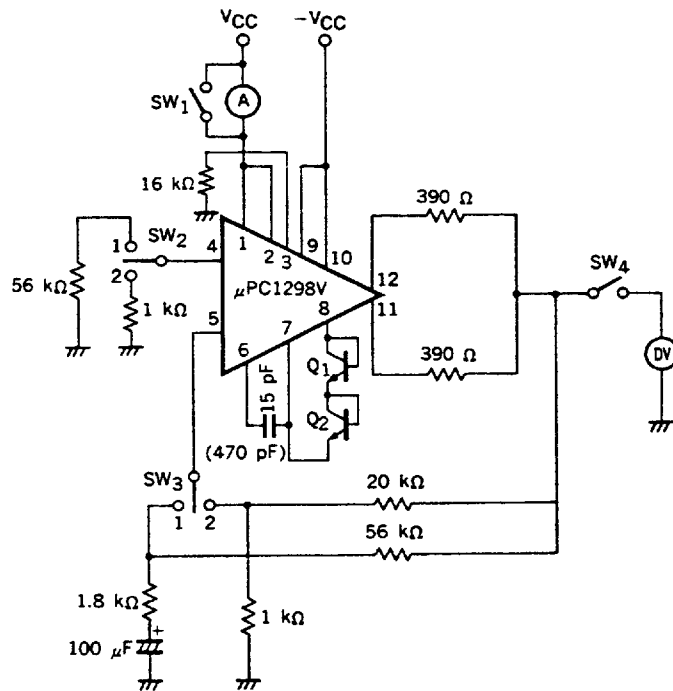

Q1 } 2SC1844F  
Q2 }

SWITCH POSITION

	SW <sub>1</sub>	SW <sub>2</sub>	SW <sub>3</sub>	SW <sub>4</sub>
$I_{CC}$	OFF	2	2	OFF
$V_{OFF}$	ON	1	1	ON

TEST CIRCUIT 2 (V<sub>OM</sub>, A<sub>v</sub>, A<sub>vO</sub>, V<sub>NO</sub>, SVR, PBW)

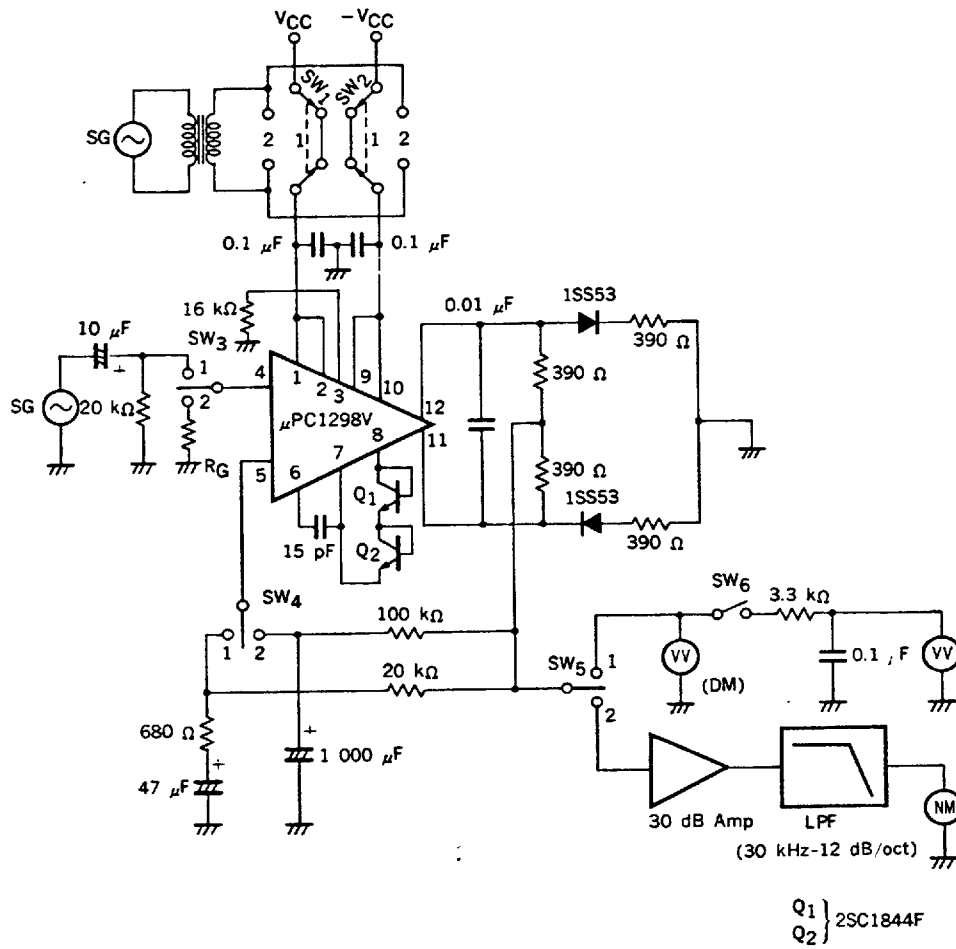

SWITCH POSITION

	SW <sub>1</sub>	SW <sub>2</sub>	SW <sub>3</sub>	SW <sub>4</sub>	SW <sub>5</sub>	SW <sub>6</sub>
V <sub>OM</sub>	1	1	1	1	1	OFF
A <sub>v</sub>	1	1	1	1	1	OFF
A <sub>vO</sub>	1	1	1	2	1	OFF
V <sub>NO</sub>	1	1	2	1	2	OFF
SVR	2/1	1/2	2	1	1	ON
PBW	1	1	1	1	1	OFF

APPLICATION CIRCUIT

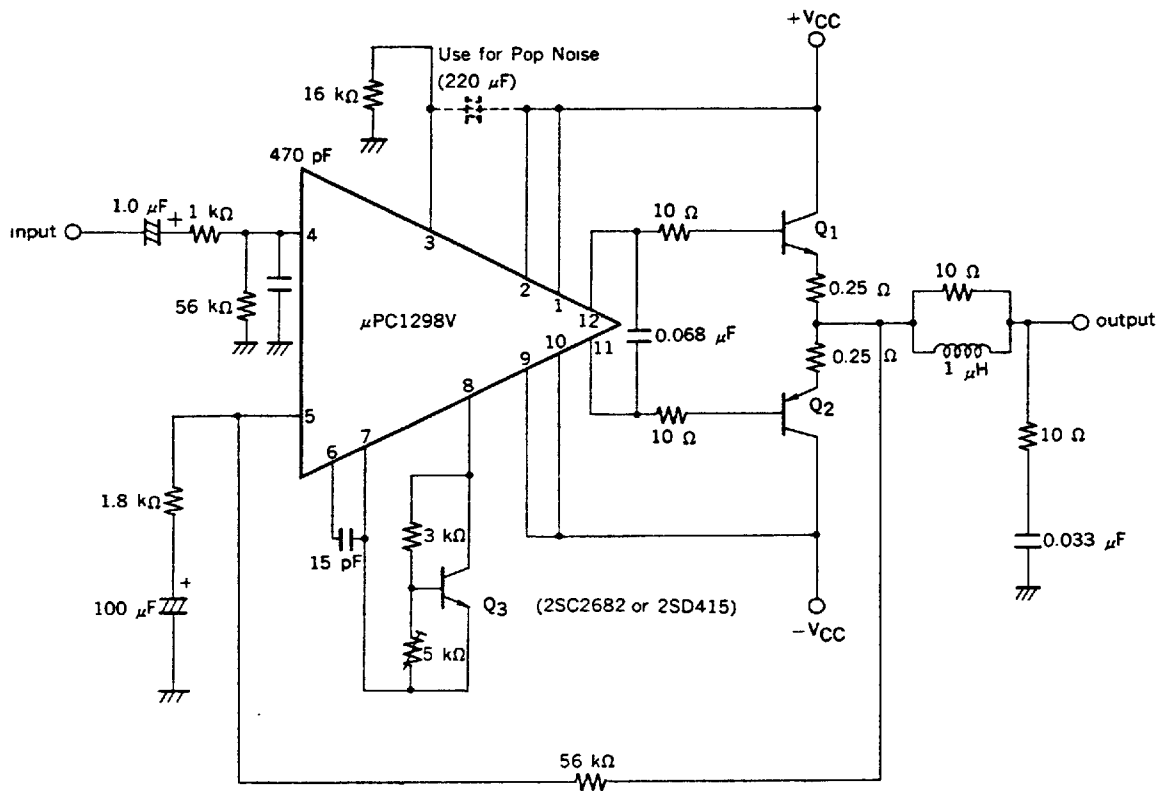

RECOMMENDED POWER TRANSISTOR

P <sub>O</sub>	25 to 40 W	45 to 55 W	50 to 70 W	70 to 80 W
Q <sub>1</sub>	2SD1288 2SD2013	2SD1289 2SD1977	2SC3012 2SC4267	2SC2987 2SC2987A 2SC4268
Q <sub>2</sub>	2SB965 2SB1336	2SB966 2SB1315	2SA1232 2SA1631	2SA1227 2SA1227A 2SA1632

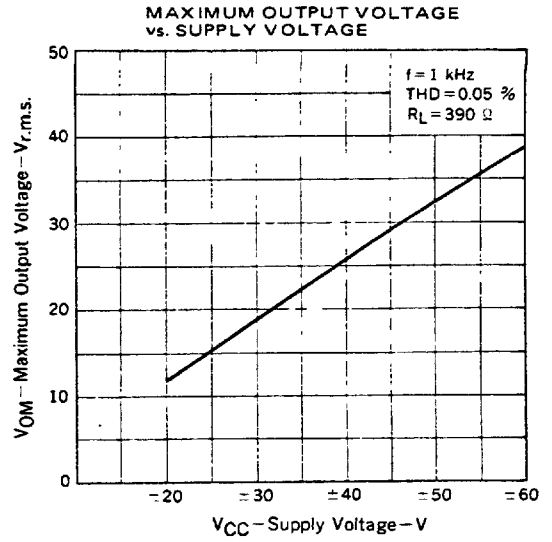
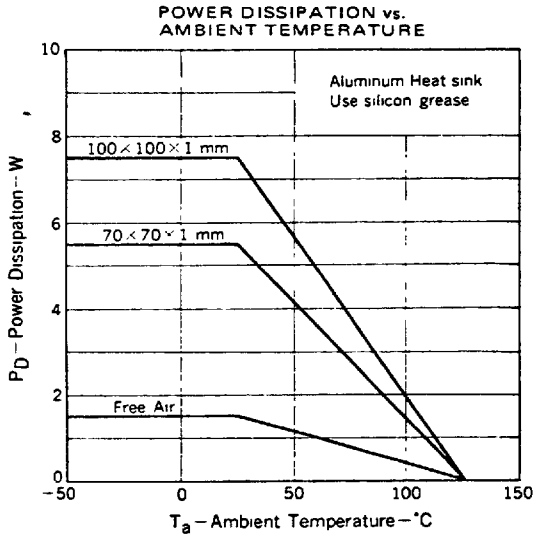

**OPEN LOOP VOLTAGE GAIN, SUPPLY VOLTAGE REJECTION RATIO, OUTPUT NOISE VOLTAGE, CIRCUIT CURRENT, OUTPUT OFFSET VOLTAGE vs. SUPPLY VOLTAGE**

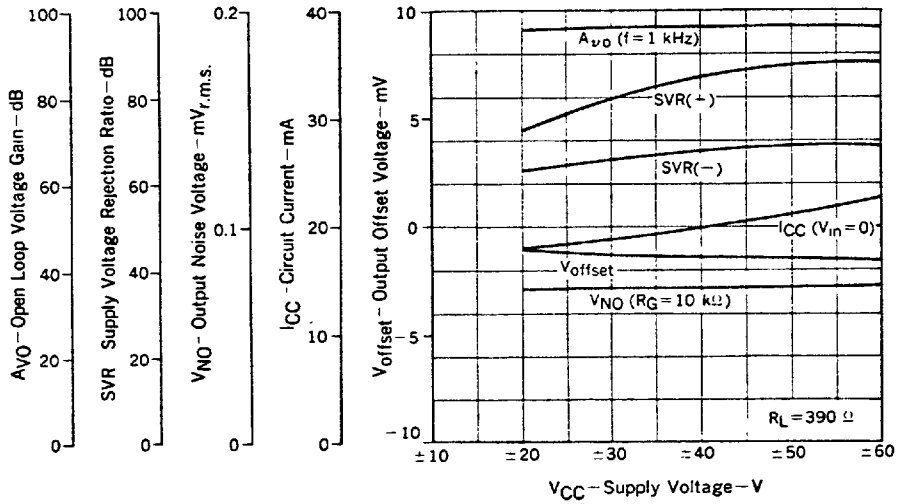

**OPEN LOOP VOLTAGE GAIN, OUTPUT NOISE VOLTAGE, CIRCUIT CURRENT, OUTPUT OFFSET VOLTAGE vs. AMBIENT TEMPERATURE**

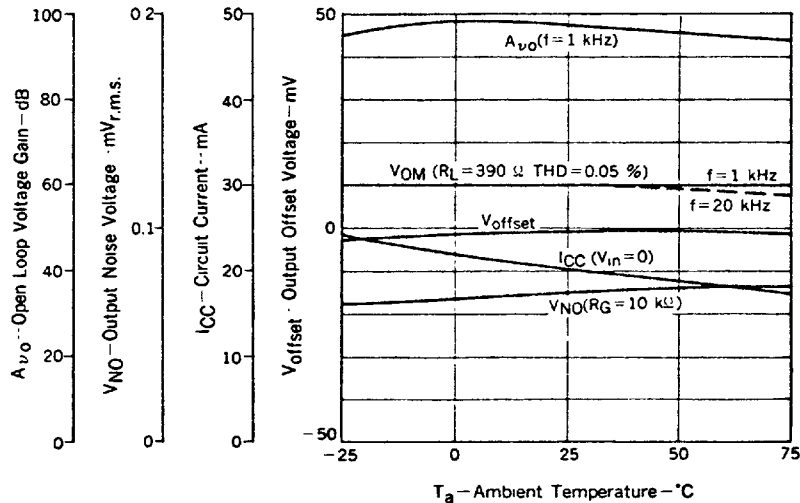

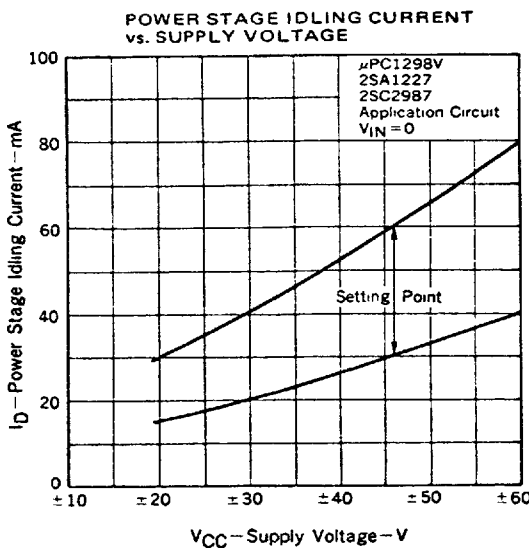
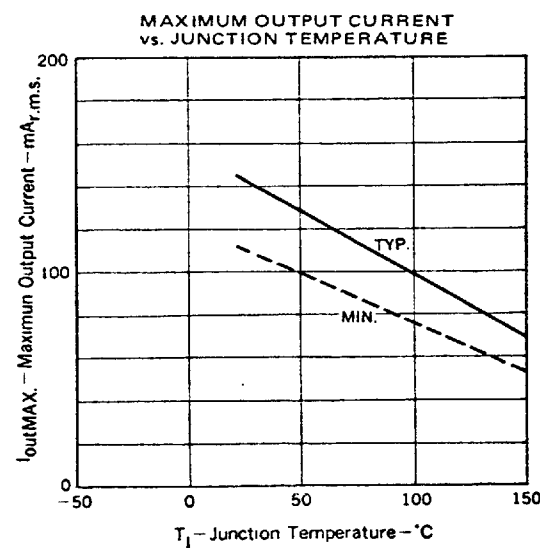
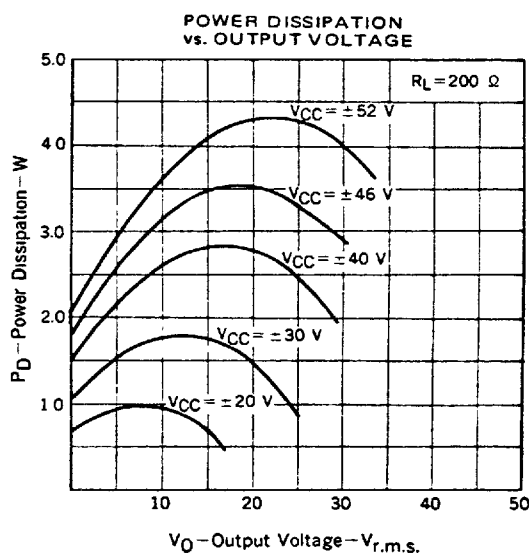
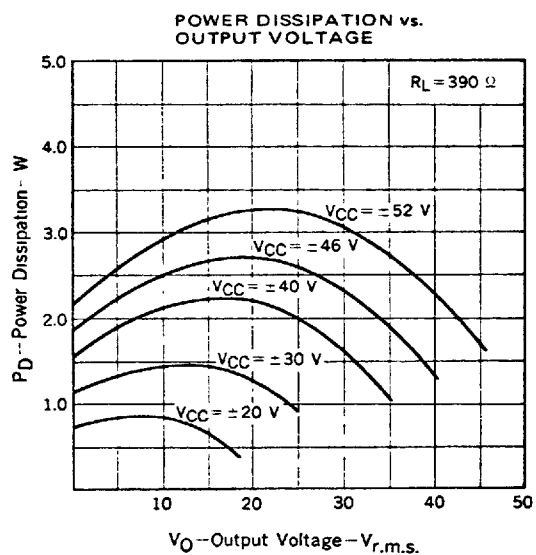
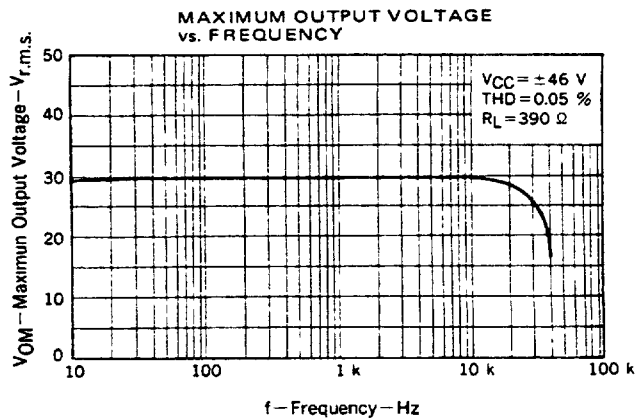
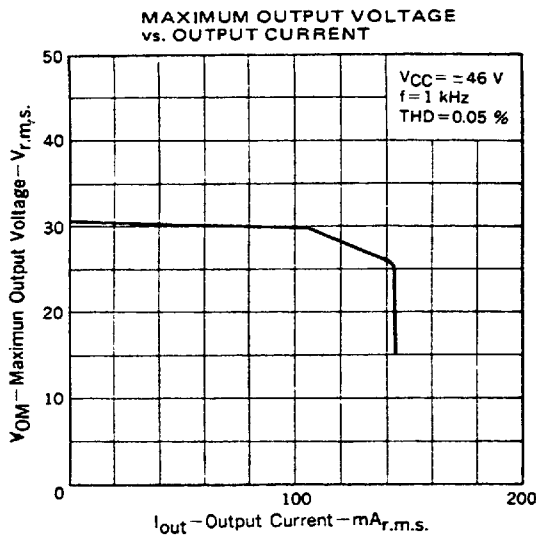

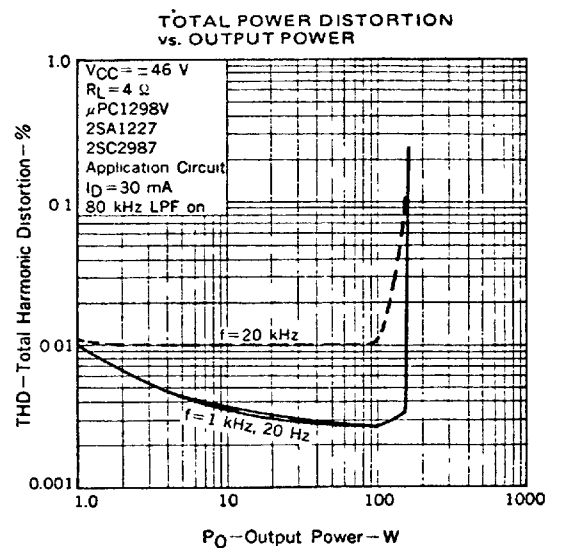
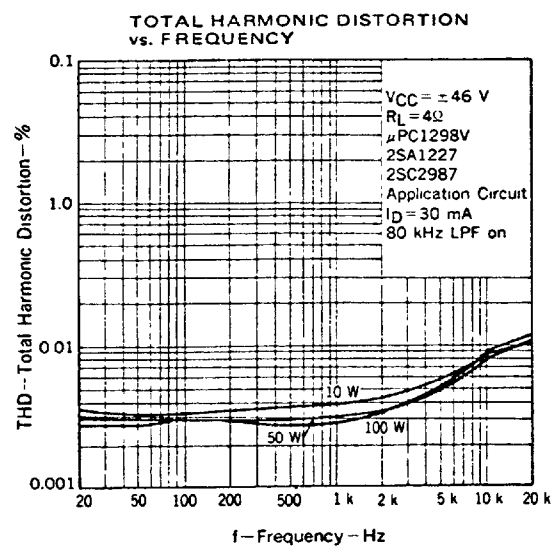
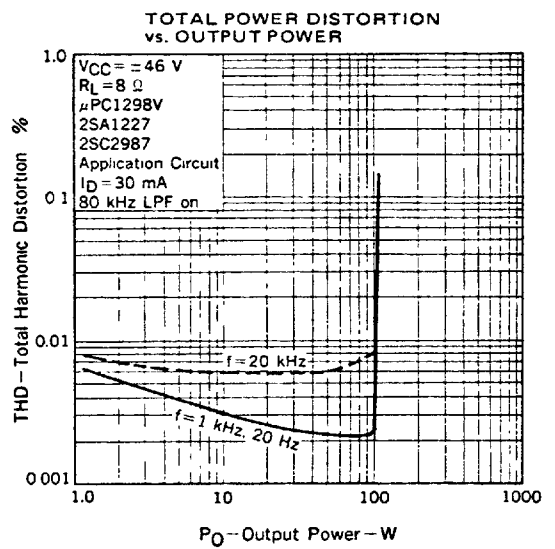
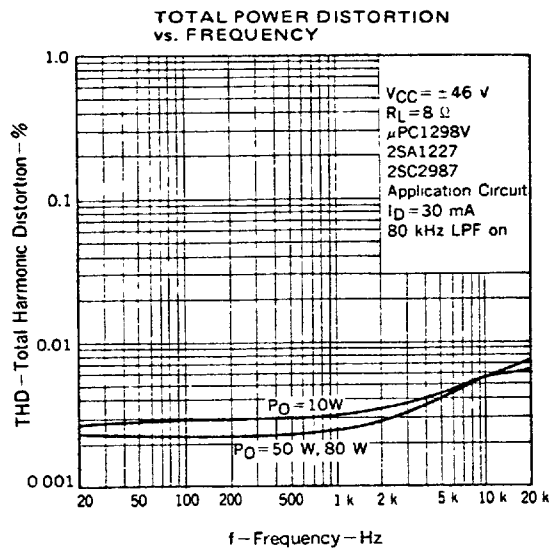
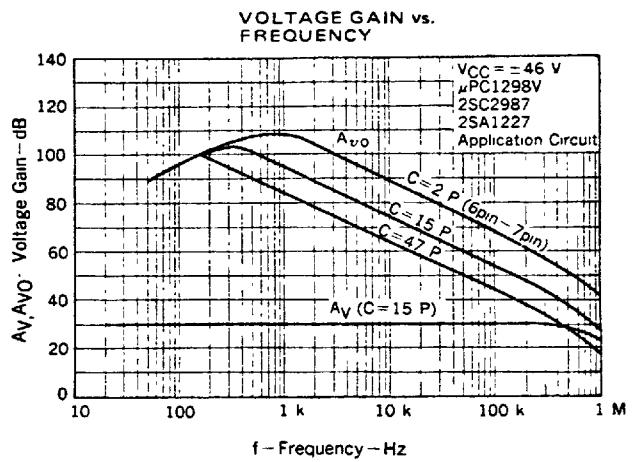
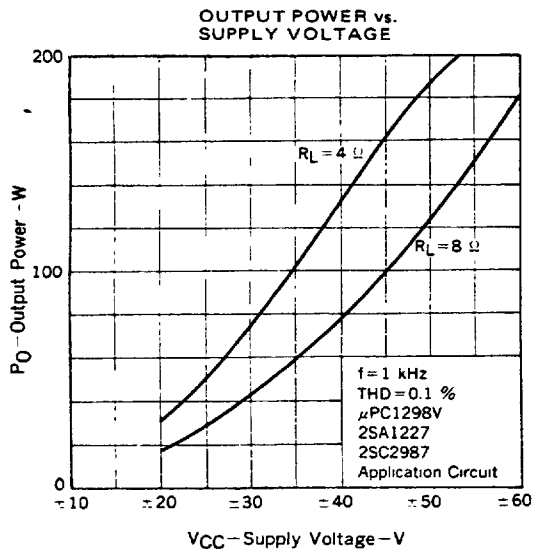



PACKAGE DIMENSIONS (Unit : mm)

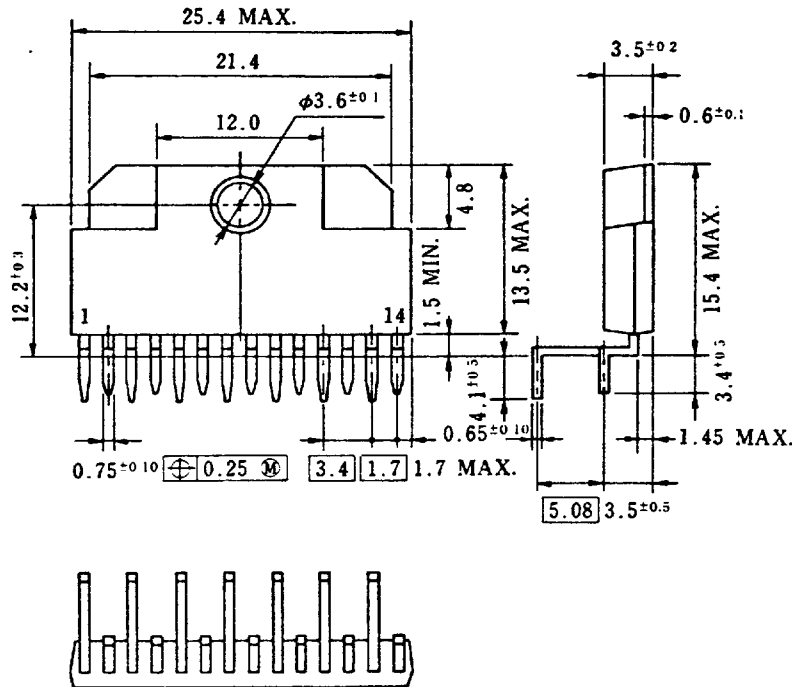

PIN CONNECTION DIAGRAM

PIN No.	PIN CONNECTION
1	+V <sub>CCD</sub> (for Driver)
2	+V <sub>CCP</sub> (for Preamp)
3	MUTING
4	INPUT
5	NFB
6	PHASE COMP
7	BIAS
8	BIAS
9	-V <sub>CCP</sub> (for Preamp)
10	-V <sub>CCD</sub> (for Driver)
11	LOWER OUTPUT
12	UPPER OUTPUT
13	NC
14	NC