

- Advanced Process Technology
- Dynamic dv/dt Rating
- 175°C Operating Temperature
- Fast Switching
- Fully Avalanche Rated

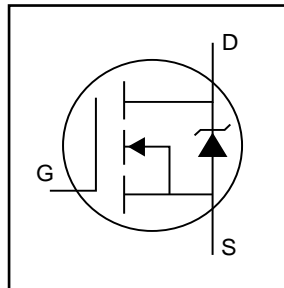

$$V_{DSS} = 55V$$

$$R_{DS(on)} = 0.012\Omega$$

$$I_D = 81A\text{⑥}$$

Description

Fifth Generation HEXFETs from International Rectifier utilize advanced processing techniques to achieve extremely low on-resistance per silicon area. This benefit, combined with the fast switching speed and ruggedized device design that HEXFET Power MOSFETs are well known for, provides the designer with an extremely efficient and reliable device for use in a wide variety of applications.

The TO-247 package is preferred for commercial-industrial applications where higher power levels preclude the use of TO-220 devices. The TO-247 is similar but superior to the earlier TO-218 package because of its isolated mounting hole.

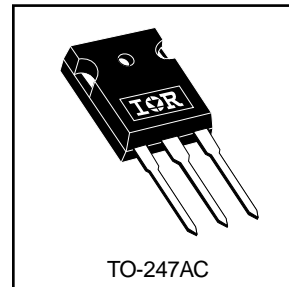

Absolute Maximum Ratings

	Parameter	Max.	Units
$I_D @ T_C = 25^\circ C$	Continuous Drain Current, $V_{GS} @ 10V$	81⑥	A
$I_D @ T_C = 100^\circ C$	Continuous Drain Current, $V_{GS} @ 10V$	57	
I_{DM}	Pulsed Drain Current ①⑤	290	
$P_D @ T_C = 25^\circ C$	Power Dissipation	170	W
	Linear Derating Factor	1.1	W/°C
V_{GS}	Gate-to-Source Voltage	± 20	V
E_{AS}	Single Pulse Avalanche Energy ②⑤	360	mJ
I_{AR}	Avalanche Current ①	43	A
E_{AR}	Repetitive Avalanche Energy ①	17	mJ
dv/dt	Peak Diode Recovery dv/dt ③⑤	5.0	V/ns
T_J	Operating Junction and	-55 to + 175	°C
T_{STG}	Storage Temperature Range		
	Soldering Temperature, for 10 seconds		
	Mounting torque, 6-32 or M3 screw	10 lbf•in (1.1N•m)	

Thermal Resistance

	Parameter	Typ.	Max.	Units
$R_{\theta JC}$	Junction-to-Case	—	0.90	°C/W
$R_{\theta CS}$	Case-to-Sink, Flat, Greased Surface	0.24	—	
$R_{\theta JA}$	Junction-to-Ambient	—	40	

Electrical Characteristics @ $T_J = 25^\circ\text{C}$ (unless otherwise specified)

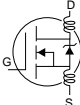
	Parameter	Min.	Typ.	Max.	Units	Conditions
$V_{(BR)DSS}$	Drain-to-Source Breakdown Voltage	55	—	—	V	$V_{GS} = 0V, I_D = 250\mu A$
$\Delta V_{(BR)DSS}/\Delta T_J$	Breakdown Voltage Temp. Coefficient	—	0.06	—	V/°C	Reference to $25^\circ\text{C}, I_D = 1\text{mA}$ ⑤
$R_{DS(on)}$	Static Drain-to-Source On-Resistance	—	—	0.012	Ω	$V_{GS} = 10V, I_D = 43A$ ④
$V_{GS(th)}$	Gate Threshold Voltage	2.0	—	4.0	V	$V_{DS} = V_{GS}, I_D = 250\mu A$
g_{fs}	Forward Transconductance	30	—	—	S	$V_{DS} = 25V, I_D = 43A$ ⑤
I_{DSS}	Drain-to-Source Leakage Current	—	—	25	μA	$V_{DS} = 55V, V_{GS} = 0V$
		—	—	250		$V_{DS} = 44V, V_{GS} = 0V, T_J = 150^\circ\text{C}$
I_{GSS}	Gate-to-Source Forward Leakage	—	—	100	nA	$V_{GS} = 20V$
	Gate-to-Source Reverse Leakage	—	—	-100		$V_{GS} = -20V$
Q_g	Total Gate Charge	—	—	130	nC	$I_D = 43A$
Q_{gs}	Gate-to-Source Charge	—	—	23		$V_{DS} = 44V$
Q_{gd}	Gate-to-Drain ("Miller") Charge	—	—	53		$V_{GS} = 10V$, See Fig. 6 and 13 ④ ⑤
$t_{d(on)}$	Turn-On Delay Time	—	11	—	ns	$V_{DD} = 28V$
t_r	Rise Time	—	66	—		$I_D = 43A$
$t_{d(off)}$	Turn-Off Delay Time	—	40	—		$R_G = 3.6\Omega$
t_f	Fall Time	—	46	—		$R_D = 0.62\Omega$, See Fig. 10 ④ ⑤
L_D	Internal Drain Inductance	—	5.0	—	nH	Between lead, 6mm (0.25in.) from package and center of die contact
L_S	Internal Source Inductance	—	13	—		
C_{iss}	Input Capacitance	—	2900	—	pF	$V_{GS} = 0V$
C_{oss}	Output Capacitance	—	880	—		$V_{DS} = 25V$
C_{rss}	Reverse Transfer Capacitance	—	330	—		$f = 1.0\text{MHz}$, See Fig. 5 ⑤

Source-Drain Ratings and Characteristics

	Parameter	Min.	Typ.	Max.	Units	Conditions
I_S	Continuous Source Current (Body Diode)	—	—	81 ⑥	A	MOSFET symbol showing the integral reverse p-n junction diode.
I_{SM}	Pulsed Source Current (Body Diode) ①	—	—	290		
V_{SD}	Diode Forward Voltage	—	—	1.3	V	$T_J = 25^\circ\text{C}, I_S = 43A, V_{GS} = 0V$ ④
t_{rr}	Reverse Recovery Time	—	81	120	ns	$T_J = 25^\circ\text{C}, I_F = 43A$
Q_{rr}	Reverse Recovery Charge	—	240	370	nC	$di/dt = 100A/\mu s$ ④ ⑤

Notes:

① Repetitive rating; pulse width limited by max. junction temperature. (See fig. 11)

② $V_{DD} = 25V$, starting $T_J = 25^\circ\text{C}$, $L = 390\mu H$
 $R_G = 25\Omega$, $I_{AS} = 43A$. (See Figure 12)

③ $I_{SD} \leq 43A$, $di/dt \leq 260A/\mu s$, $V_{DD} \leq V_{(BR)DSS}$,
 $T_J \leq 175^\circ\text{C}$

④ Pulse width $\leq 300\mu s$; duty cycle $\leq 2\%$.

⑤ Uses IRF1010N data and test conditions

⑥ Calculated continuous current based on maximum allowable junction temperature; for recommended current-handling of the package refer to Design Tip # 93-4

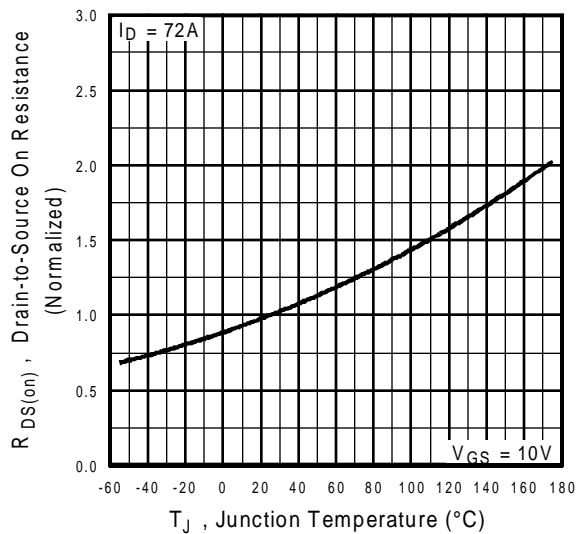
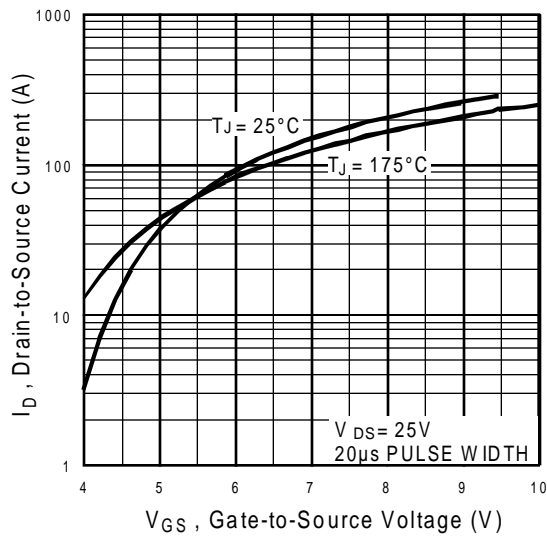
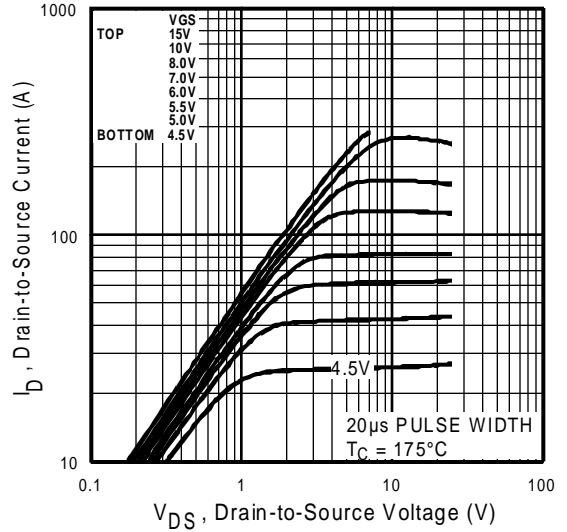
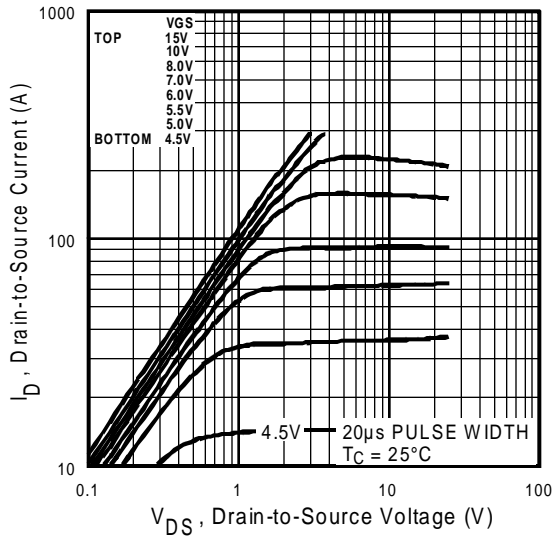

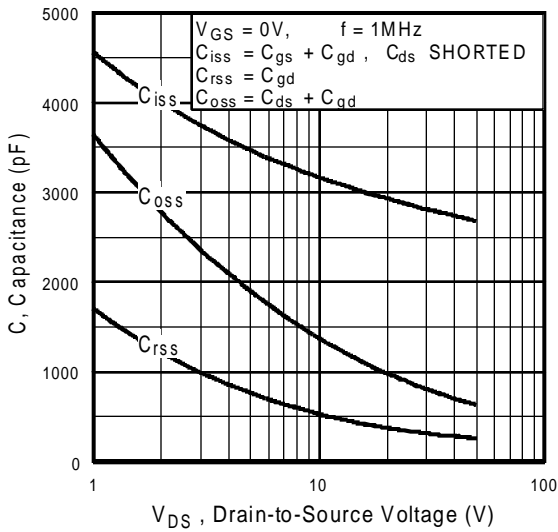

Fig 5. Typical Capacitance Vs. Drain-to-Source Voltage

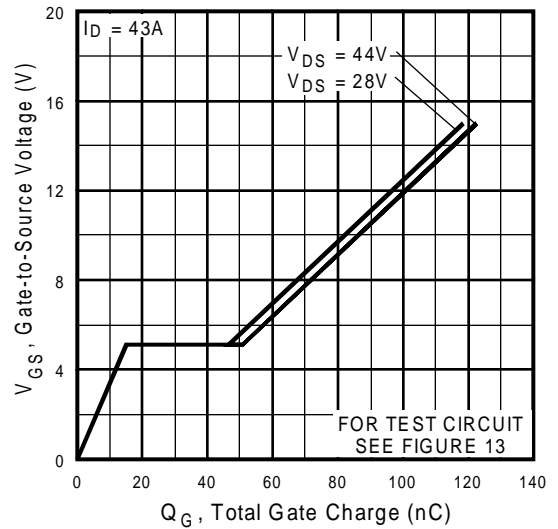

Fig 6. Typical Gate Charge Vs. Gate-to-Source Voltage

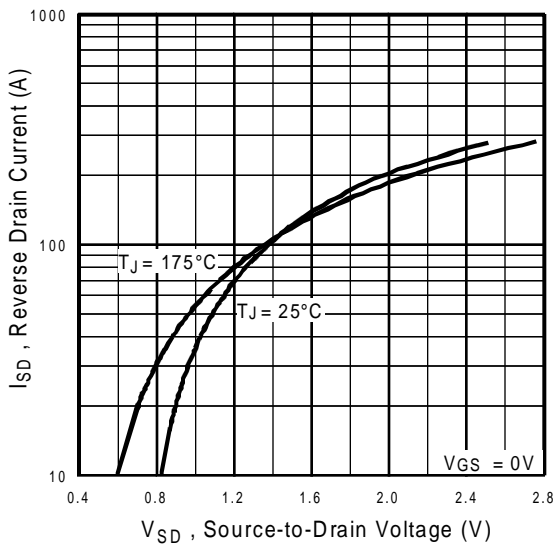

Fig 7. Typical Source-Drain Diode Forward Voltage

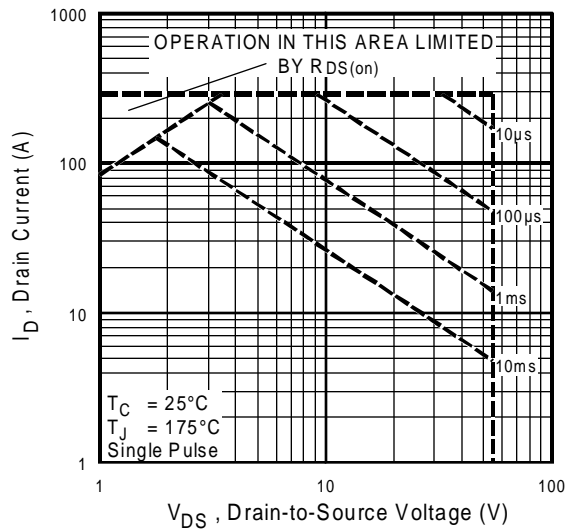

Fig 8. Maximum Safe Operating Area

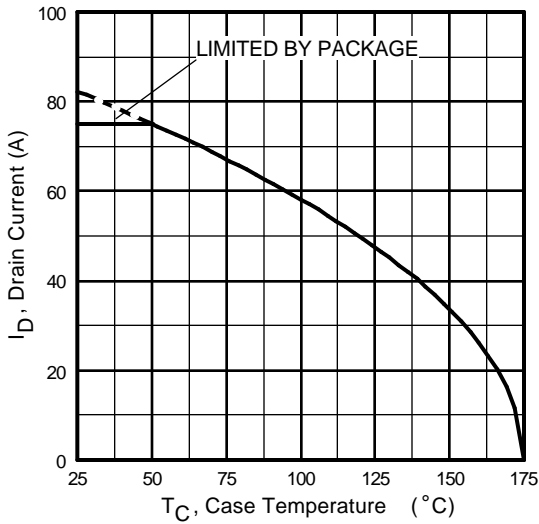

Fig 9. Maximum Drain Current Vs. Case Temperature

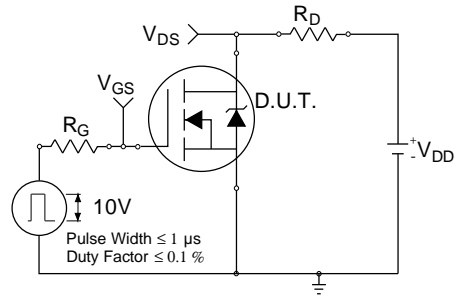

Fig 10a. Switching Time Test Circuit

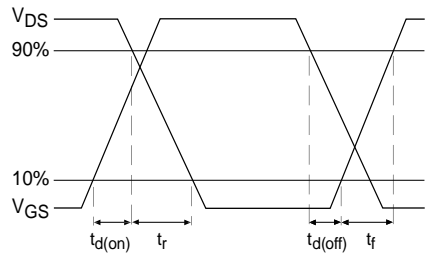

Fig 10b. Switching Time Waveforms

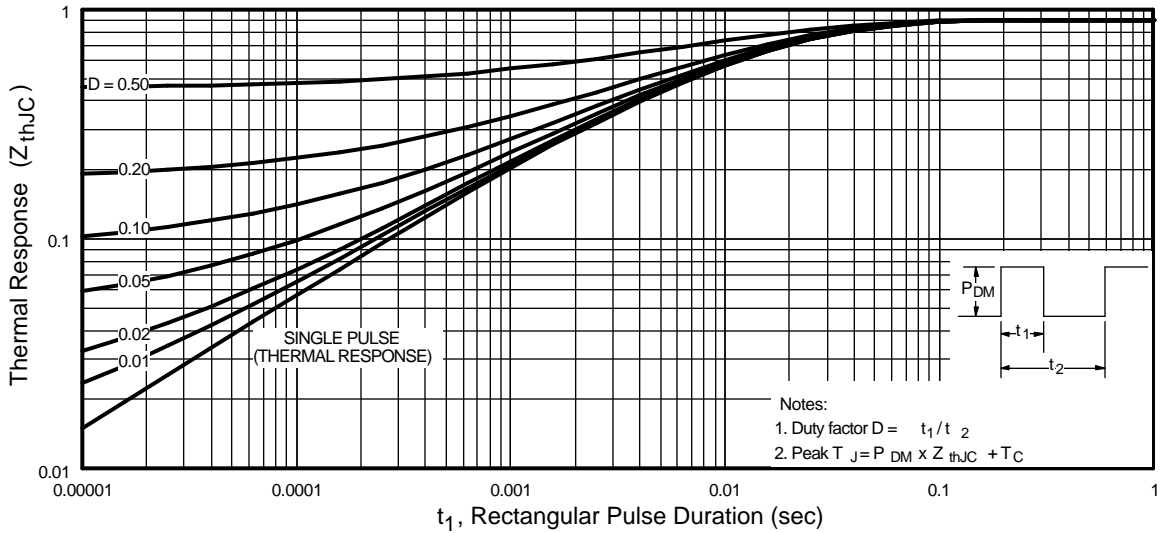

Fig 11. Maximum Effective Transient Thermal Impedance, Junction-to-Case

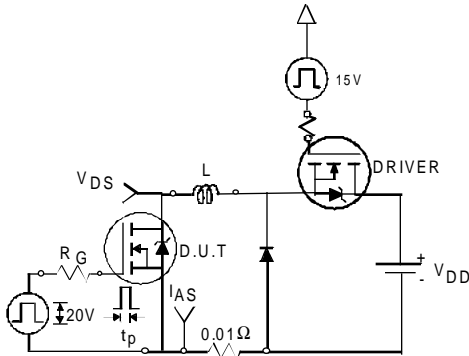

Fig 12a. Unclamped Inductive Test Circuit

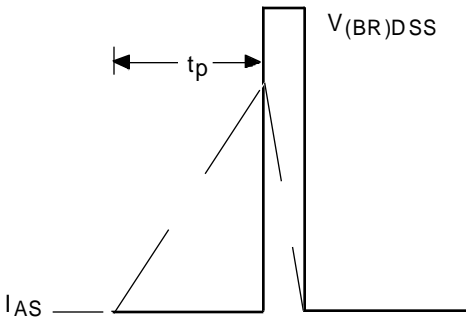

Fig 12b. Unclamped Inductive Waveforms

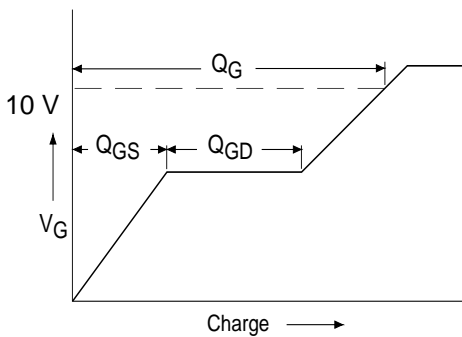

Fig 13a. Basic Gate Charge Waveform

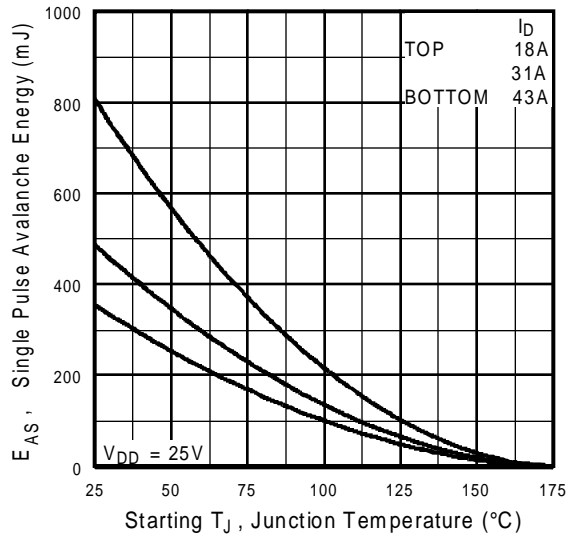

Fig 12c. Maximum Avalanche Energy Vs. Drain Current

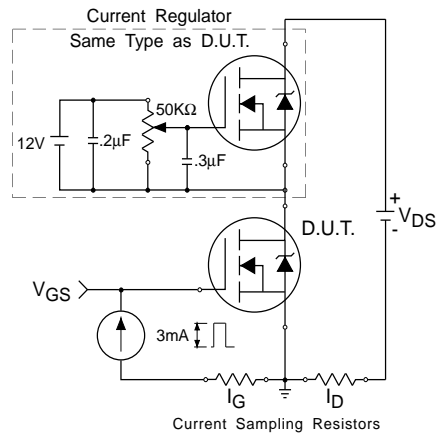
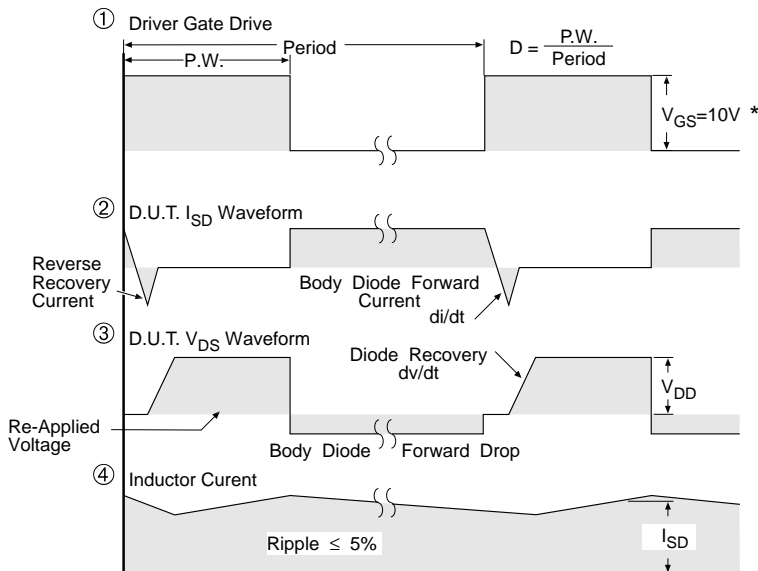

Fig 13b. Gate Charge Test Circuit

Peak Diode Recovery dv/dt Test Circuit



* $V_{GS} = 5V$ for Logic Level Devices

Fig 14. For N-Channel HEXFETS

Package Outline

TO-247AC Outline

Dimensions are shown in millimeters (inches)

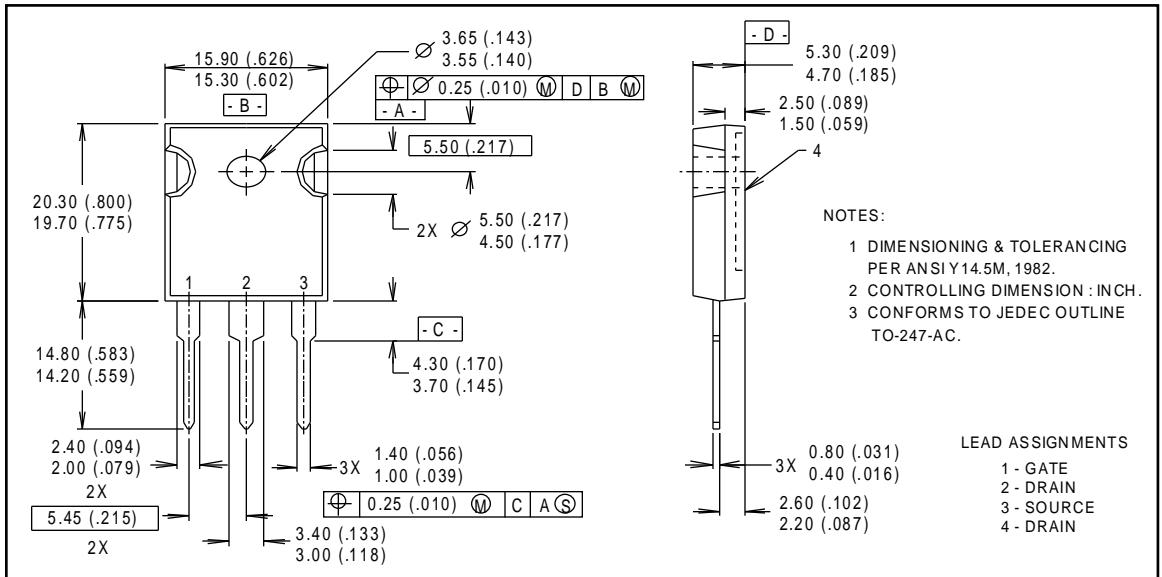

Part Marking Information

TO-247AC

