



# TS271C,I,M

## CMOS PROGRAMMABLE LOW POWER SINGLE OPERATIONAL AMPLIFIER

- OFFSET NULL CAPABILITY (by external compensation)
- DYNAMIC CHARACTERISTICS ADJUSTABLE  $I_{SET}$
- CONSUMPTION CURRENT AND DYNAMIC PARAMETERS ARE STABLE REGARDING THE VOLTAGE POWER SUPPLY VARIATIONS
- OUTPUT VOLTAGE CAN SWING TO GROUND
- VERY LARGE  $I_{SET}$  RANGE
- STABLE AND LOW OFFSET VOLTAGE
- THREE INPUT OFFSET VOLTAGE SELECTIONS

### DESCRIPTION

The TS271 is a low cost, low power single operational amplifier designed to operate with single or dual supplies. This operational amplifier uses the ST silicon gate CMOS process giving it an excellent consumption-speed ratio. This amplifier is ideally suited for low consumption applications.

The power supply is externally programmable with a resistor connected between pins 8 and 4. It allows to choose the best consumption-speed ratio and supply current can be minimized according to the required speed. This device is specified for the following  $I_{SET}$  current values : 1.5 $\mu$ A, 25 $\mu$ A, 130 $\mu$ A.

This CMOS amplifier offers very high input impedance and extremely low input currents. The major advantage versus JFET devices is the very low input currents drift with temperature (see figure 3).

### ORDER CODE

Part Number	Temperature Range	Package	
		N	D
TS271C/AC/BC	0°C, +70°C	•	•
TS271I/AI/BI	-40°C, +125°C	•	•
TS271M/AM/BM	-55°C, +125°C	•	•

**Example** : TS271ACN

N = Dual in Line Package (DIP)  
D = Small Outline Package (SO) - also available in Tape & Reel (DT)

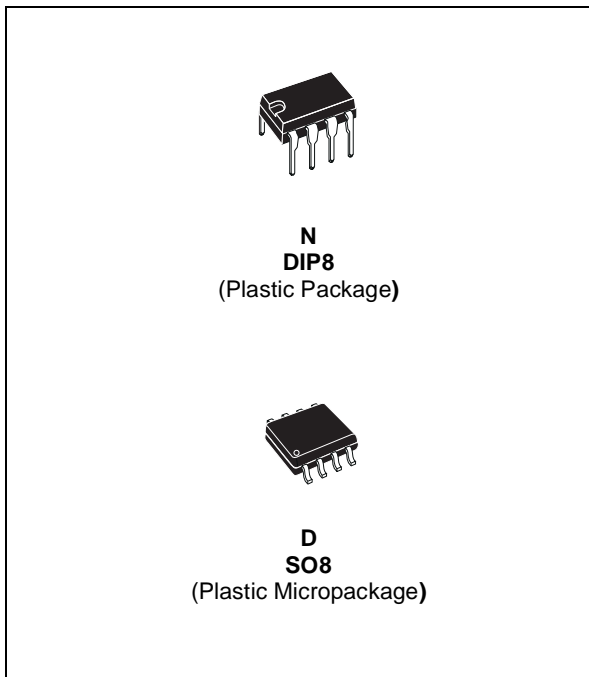

### PIN CONNECTIONS (top view)

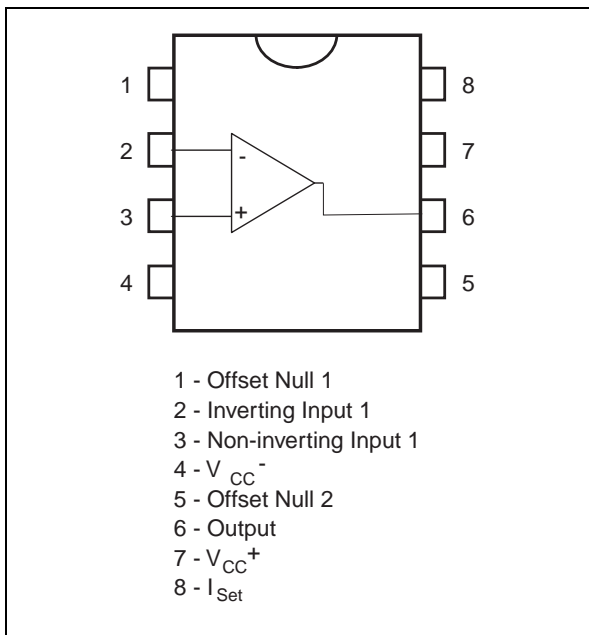

**BLOCK DIAGRAM**

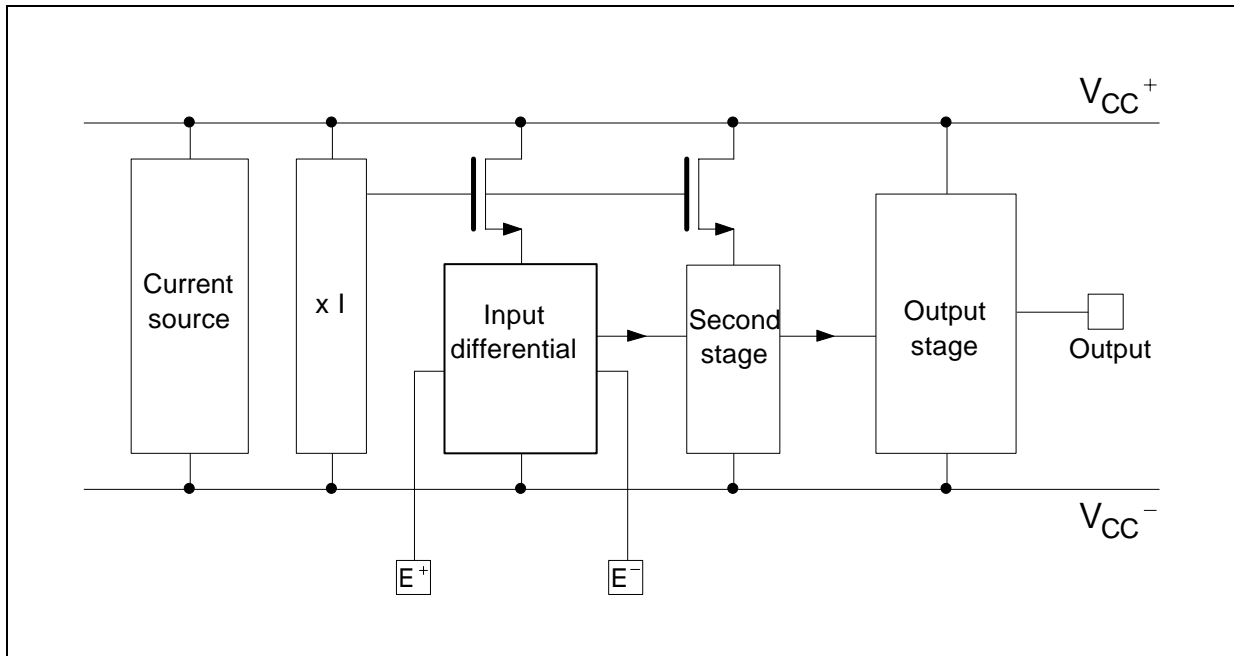

**ABSOLUTE MAXIMUM RATINGS**

Symbol	Parameter	TS271C/AC/BC	TS271I/AI/BI	TS271M/AM/BM	Unit
$V_{CC}^+$	Supply Voltage <sup>1)</sup>	18			V
$V_{id}$	Differential Input Voltage <sup>2)</sup>	±18			V
$V_i$	Input Voltage <sup>3)</sup>	-0.3 to 18			V
$I_o$	Output Current for $V_{CC}^+ \geq 15V$	±30			mA
$I_{in}$	Input Current	±5			mA
$T_{oper}$	Operating Free-Air Temperature Range	0 to +70	-40 to +125	-55 to +125	°C
$T_{stg}$	Storage Temperature Range	-65 to +150			°C

1. All values, except differential voltage are with respect to network ground terminal.
2. Differential voltages are the non-inverting input terminal with respect to the inverting input terminal.
3. The magnitude of the input and the output voltages must never exceed the magnitude of the positive supply voltage.

**OPERATING CONDITIONS**

Symbol	Parameter	Value	Unit
$V_{CC}^+$	Supply Voltage	3 to 16	V
$V_{icm}$	Common Mode Input Voltage Range	0 to $V_{CC}^+ - 1.5$	V

SCHEMATIC DIAGRAM

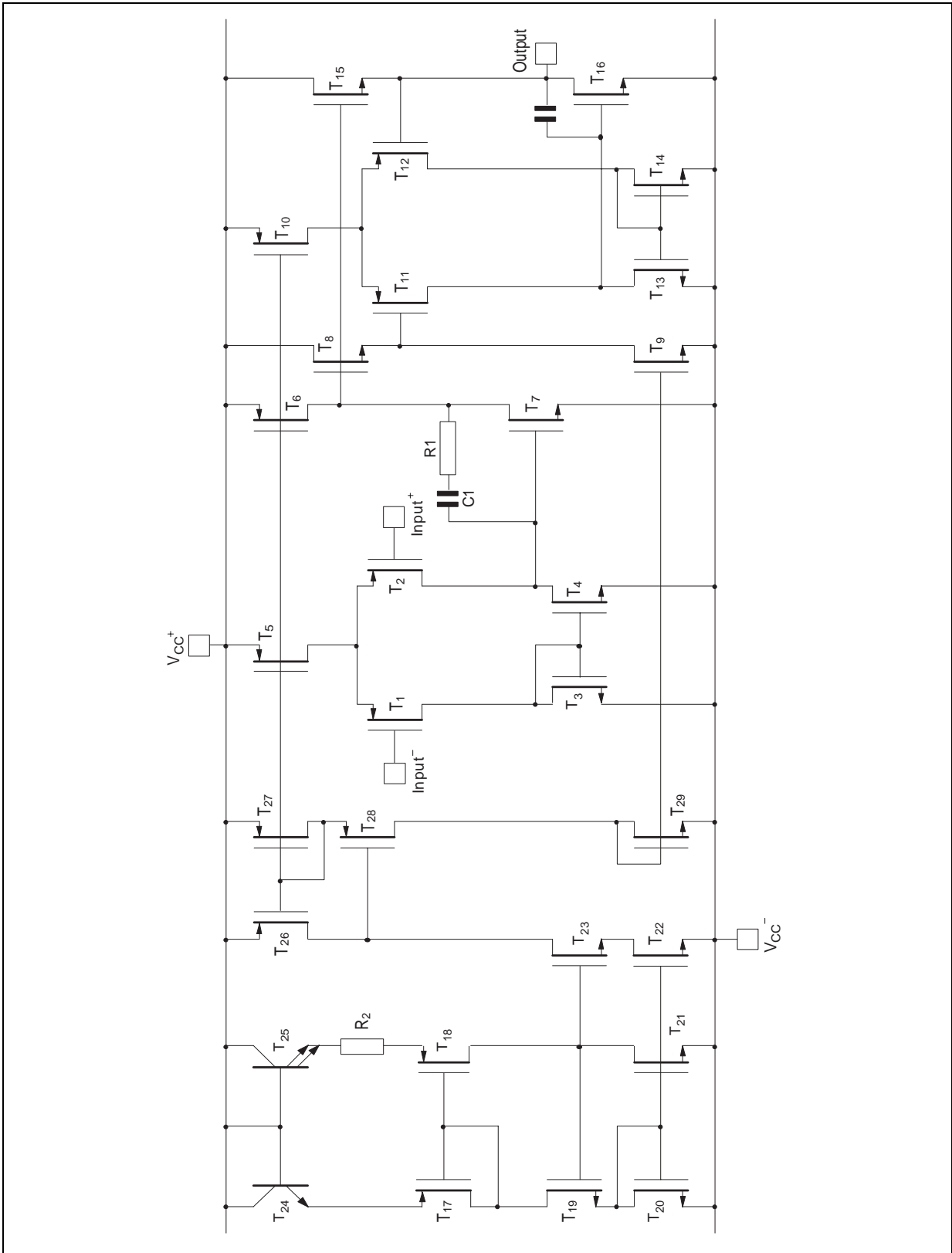

OFFSET VOLTAGE NULL CIRCUIT

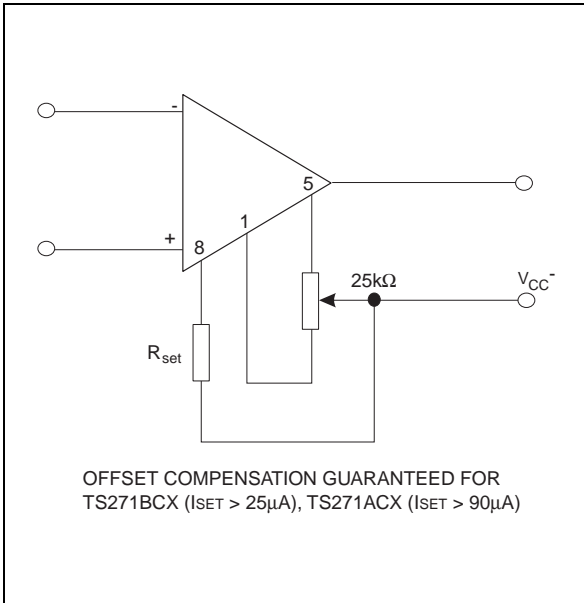

RESISTOR BIASING

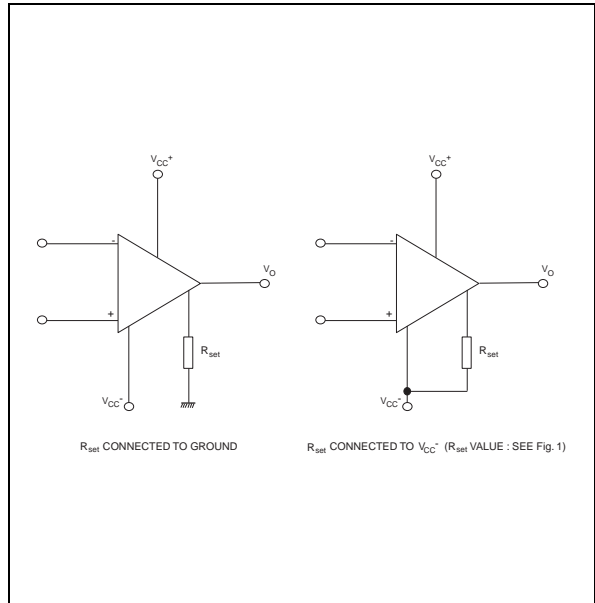
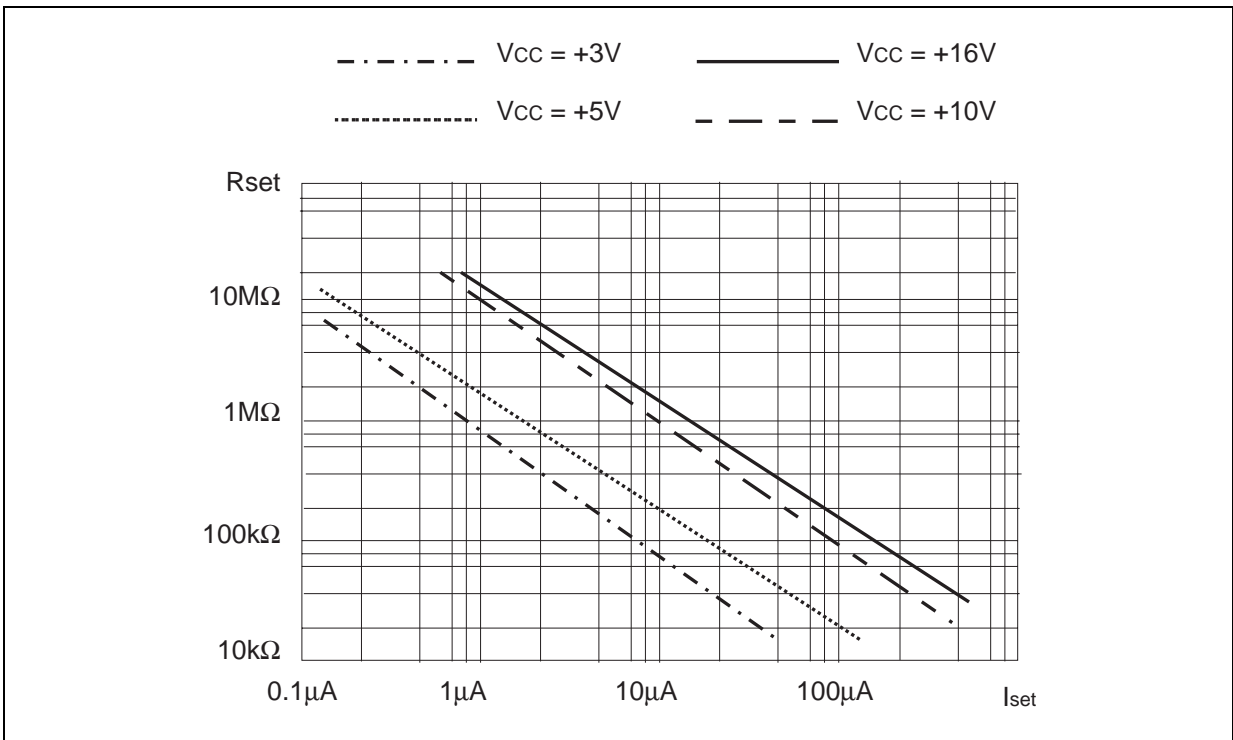

Figure 1 :  $R_{SET}$  Connected to  $V_{CC}^-$



**ELECTRICAL CHARACTERISTICS for  $I_{SET} = 1.5\mu A$**  $V_{CC}^+ = +10V$ ,  $V_{CC}^- = 0V$ ,  $T_{amb} = +25^\circ C$  (unless otherwise specified)

Symbol	Parameter	TS271C/AC/BC			TS271I/AI/BI TS271M/AM/BM			Unit
		Min.	Typ.	Max.	Min.	Typ.	Max.	
$V_{io}$	Input Offset Voltage $V_O = 1.4V$ , $V_{ic} = 0V$		1.1	10		1.1	10	mV
	TS271C/I/M TS271AC/AI/AM TS271B/C/I/M		0.9 0.25	5 2		0.9 0.25	5 2	
	$T_{min} \leq T_{amb} \leq T_{max}$			12		12	12	
				6.5		6.5	6.5	
				3		3	3.5	
$DV_{io}$	Input Offset Voltage Drift		2			2		$\mu V/^\circ C$
$I_{io}$	Input Offset Current note 1) $V_{ic} = 5V$ , $V_O = 5V$ $T_{min} \leq T_{amb} \leq T_{max}$		1	100		1	200	pA
$I_{ib}$	Input Bias Current - see note 1 $V_{ic} = 5V$ , $V_O = 5V$ $T_{min} \leq T_{amb} \leq T_{max}$		1	150		1	300	pA
$V_{OH}$	High Level Output Voltage $V_{id} = 100mV$ , $R_L = 1M\Omega$ $T_{min} \leq T_{amb} \leq T_{max}$	8.8 8.7	9		8.8 8.6	9		V
$V_{OL}$	Low Level Output Voltage $V_{id} = -100mV$			50			50	mV
$A_{vd}$	Large Signal Voltage Gain $V_{ic} = 5V$ , $R_L = 1M\Omega$ , $V_O = 1V$ to $6V$ $T_{min} \leq T_{amb} \leq T_{max}$	30 20	100		30 20	100		V/mV
GBP	Gain Bandwidth Product $A_v = 40dB$ , $R_L = 1M\Omega$ , $C_L = 100pF$ , $f_{in} = 100kHz$		0.1			0.1		MHz
CMR	Common Mode Rejection Ratio $V_{ic} = 1V$ to $7.4V$ , $V_O = 1.4V$	60	80		60	80		dB
SVR	Supply Voltage Rejection Ratio $V_{CC}^+ = 5V$ to $10V$ , $V_O = 1.4V$	60	80		60	80		dB
$I_{CC}$	Supply Current (per amplifier) $A_v = 1$ , no load, $V_O = 5V$ $T_{min} \leq T_{amb} \leq T_{max}$		10	15 17		10	15 18	$\mu A$
$I_o$	Output Short Circuit Current $V_O = 0V$ , $V_{id} = 100mV$		60			60		mA
$I_{sink}$	Output Sink Current $V_O = V_{CC}$ , $V_{id} = -100mV$		45			45		mA
SR	Slew Rate at Unity Gain $R_L = 1M\Omega$ , $C_L = 100pF$ , $V_i = 3$ to $7V$		0.04			0.04		V/ $\mu s$
$\phi_m$	Phase Margin at Unity Gain $A_v = 40dB$ , $R_L = 1M\Omega$ $C_L = 10pF$ $C_L = 100pF$		35 10			35 10		Degrees
$K_{OV}$	Overshoot Factor $A_v = 40dB$ , $R_L = 1M\Omega$ $C_L = 10pF$ $C_L = 100pF$		40 70			40 70		%
$e_n$	Equivalent Input Noise Voltage $f = 1kHz$ , $R_S = 100\Omega$		30			30		$\frac{nV}{\sqrt{Hz}}$

1. Maximum values including unavoidable inaccuracies of the industrial test.

TYPICAL CHARACTERISTICS for  $I_{SET} = 1.5\mu A$

Figure 2 : Supply Current versus Supply Voltage

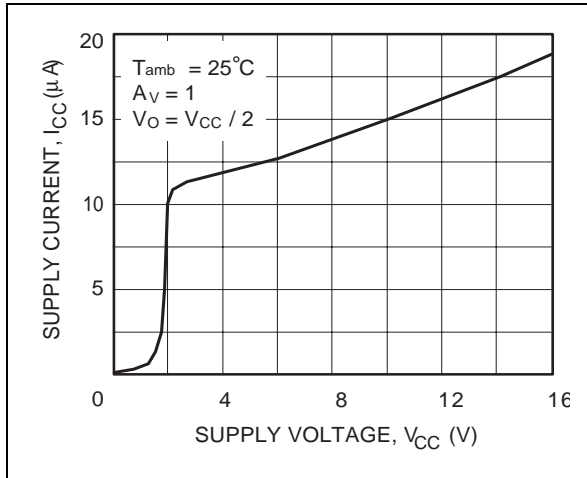

Figure 3 : Input Bias Current versus Free Air Temperature

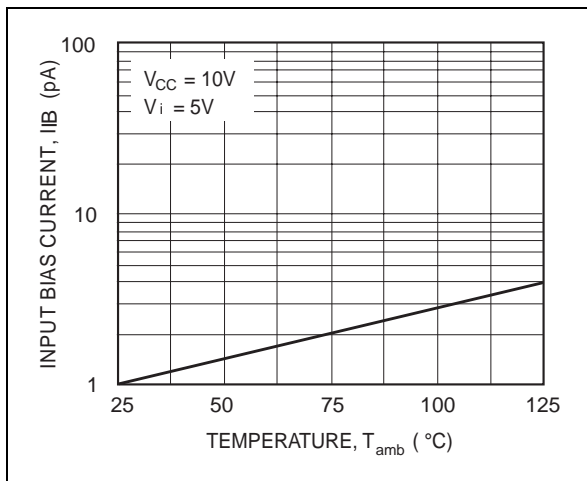

Figure 4 : High Level Output Voltage versus High Level Output Current

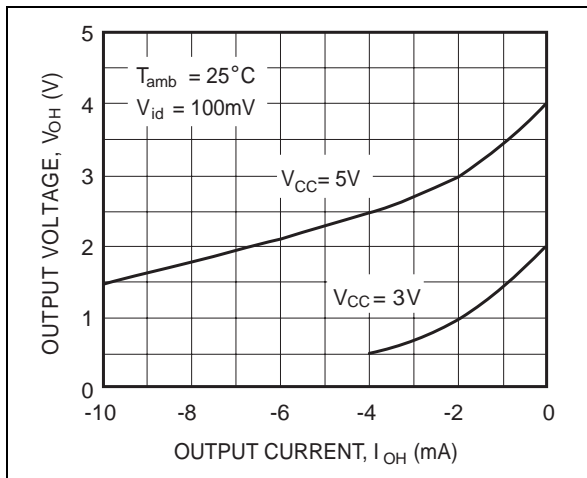

Figure 4b : High Level Output Voltage versus High Level Output Current

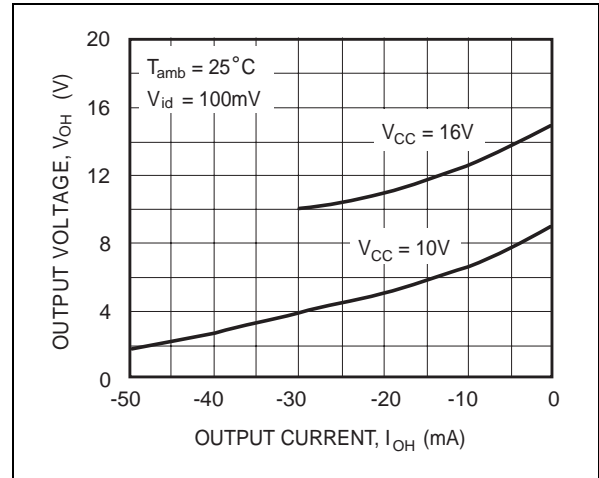

Figure 5a : Low Level Output Voltage versus Low Level Output Current

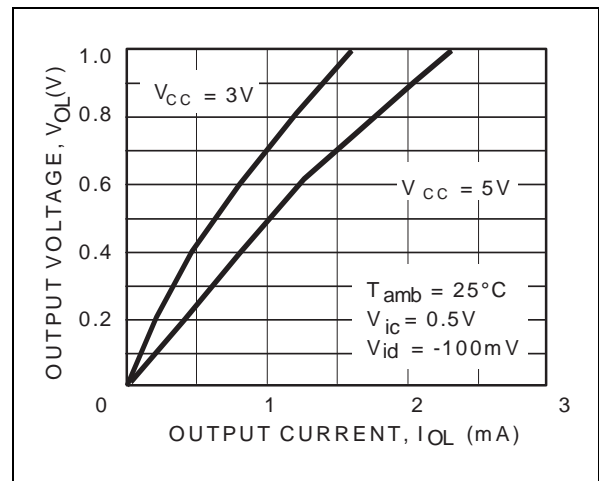
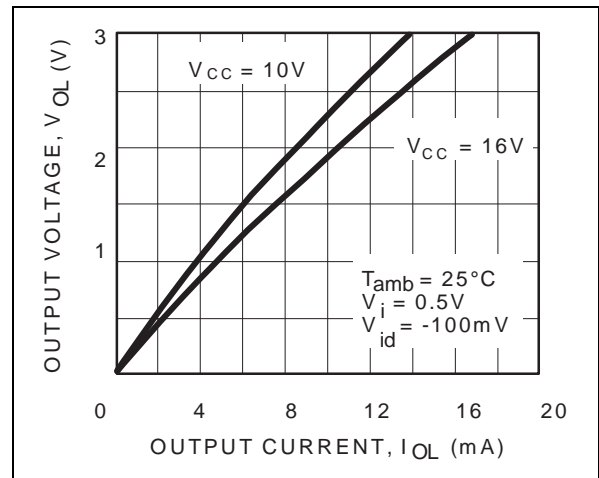
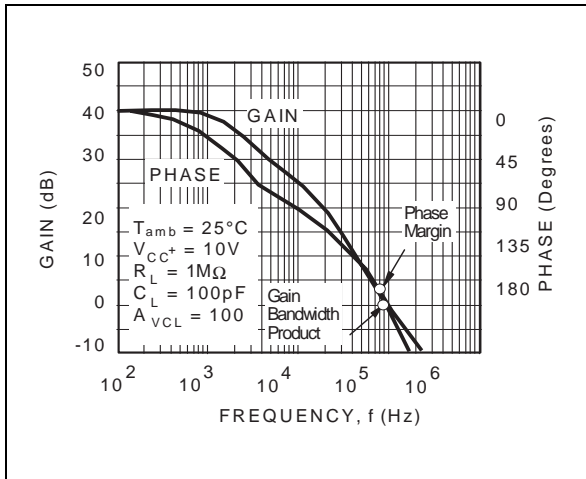

Figure 5b : Low Level Output Voltage versus Low Level Output Current



**Figure 6 : Open Loop Frequency Response and Phase Shift**



**Figure 7 : Gain Bandwidth Product versus Supply Voltage**

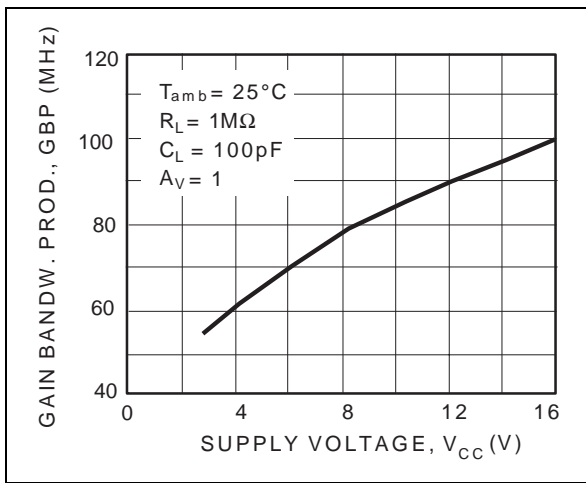

**Figure 8 : Phase Margin versus Supply Voltage**

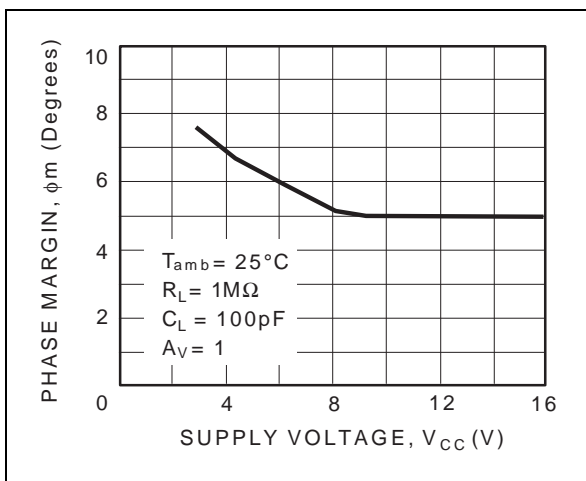

**Figure 9 : Phase Margin versus Capacitive Load**

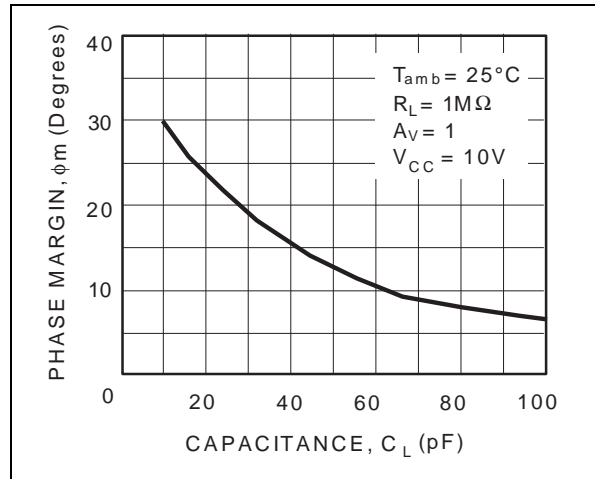

**Figure 10 : Slew Rate versus Supply Voltage**

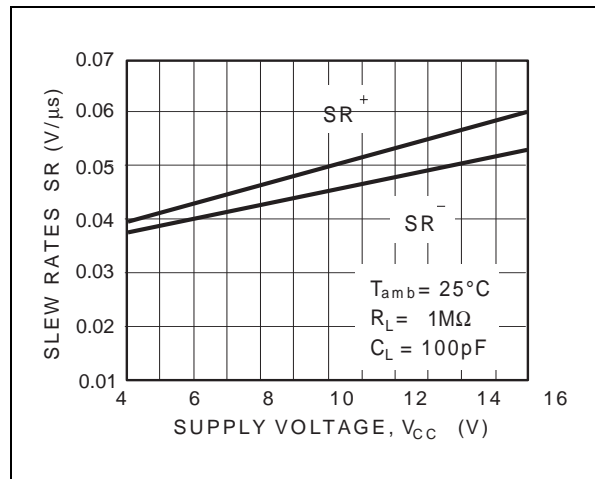

# TS271C,I,M

## ELECTRICAL CHARACTERISTICS for $I_{SET} = 25\mu A$

$V_{CC}^+ = +10V$ ,  $V_{CC}^- = 0V$ ,  $T_{amb} = +25^\circ C$  (unless otherwise specified)

Symbol	Parameter	TS271C/AC/BC			TS271I/AI/BI TS271M/AM/BM			Unit
		Min.	Typ.	Max.	Min.	Typ.	Max.	
$V_{io}$	Input Offset Voltage $V_O = 1.4V$ , $V_{ic} = 0V$ $T_{min} \leq T_{amb} \leq T_{max}$	TS271C/I/M	1.1	10		1.1	10	mV
		TS271AC/AI/AM	0.9	5		0.9	5	
		TS271C/I/M	0.25	2		0.25	2	
		TS271B/C/I/M		12			12	
		TS271AC/AI/AM		6.5			6.5	
	TS271B/C/I/M		3			3.5		
$DV_{io}$	Input Offset Voltage Drift		2			2	$\mu V/^\circ C$	
$I_{io}$	Input Offset Current note <sup>1)</sup> $V_{ic} = 5V$ , $V_O = 5V$ $T_{min} \leq T_{amb} \leq T_{max}$		1	100		1	200	pA
$I_{ib}$	Input Bias Current - see note 1 $V_{ic} = 5V$ , $V_O = 5V$ $T_{min} \leq T_{amb} \leq T_{max}$		1	150		1	300	pA
$V_{OH}$	High Level Output Voltage $V_{id} = 100mV$ , $R_L = 100k\Omega$ $T_{min} \leq T_{amb} \leq T_{max}$	8.7 8.6	8.9		8.7 8.5	8.9		V
$V_{OL}$	Low Level Output Voltage $V_{id} = -100mV$			50			50	mV
$A_{vd}$	Large Signal Voltage Gain $V_{ic} = 5V$ , $R_L = 100k\Omega$ , $V_O = 1V$ to $6V$ $T_{min} \leq T_{amb} \leq T_{max}$	30 20	50		30 10	50		V/mV
GBP	Gain Bandwidth Product $A_v = 40dB$ , $R_L = 100k\Omega$ , $C_L = 100pF$ , $f_{in} = 100kHz$		0.7			0.7		MHz
CMR	Common Mode Rejection Ratio $V_{ic} = 1V$ to $7.4V$ , $V_O = 1.4V$	60	80		60	80		dB
SVR	Supply Voltage Rejection Ratio $V_{CC}^+ = 5V$ to $10V$ , $V_O = 1.4V$	60	80		60	80		dB
$I_{CC}$	Supply Current (per amplifier) $A_v = 1$ , no load, $V_O = 5V$ $T_{min} \leq T_{amb} \leq T_{max}$		150	200 250		150	200 300	$\mu A$
$I_o$	Output Short Circuit Current $V_O = 0V$ , $V_{id} = 100mV$		60			60		mA
$I_{sink}$	Output Sink Current $V_O = V_{CC}$ , $V_{id} = -100mV$		45			45		mA
SR	Slew Rate at Unity Gain $R_L = 100k\Omega$ , $C_L = 100pF$ , $V_i = 3$ to $7V$		0.6			0.6		V/ $\mu s$
$\phi_m$	Phase Margin at Unity Gain $A_v = 40dB$ , $R_L = 100k\Omega$ , $C_L = 10pF$ $C_L = 100pF$		50 30			50 30		Degrees
$K_{OV}$	Overshoot Factor $A_v = 40dB$ , $R_L = 100k\Omega$ , $C_L = 10pF$ $C_L = 100pF$		30 50			30 50		%
$e_n$	Equivalent Input Noise Voltage $f = 1kHz$ , $R_s = 100\Omega$		38			38		$\frac{nV}{\sqrt{Hz}}$

1. Maximum values including unavoidable inaccuracies of the industrial test.



**TYPICAL CHARACTERISTICS for  $I_{SET} = 25\mu A$**

**Figure 11 :** Supply Current versus Supply Voltage

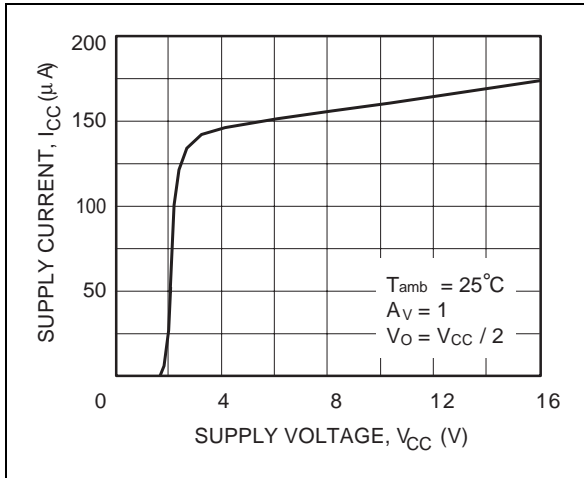

**Figure 12 :** Input Bias Current versus Free Air Temperature

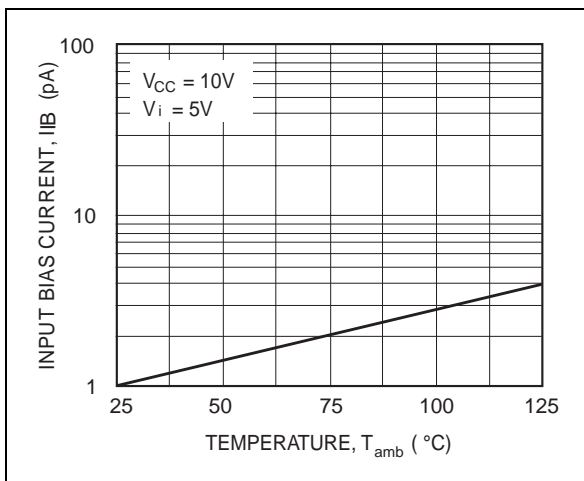

**Figure 13a :** High Level Output Voltage versus High Level Output Current

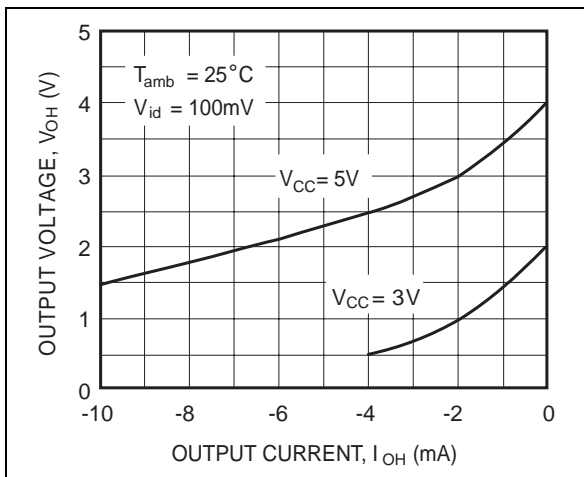

**Figure 13b :** High Level Output Voltage versus High Level Output Current

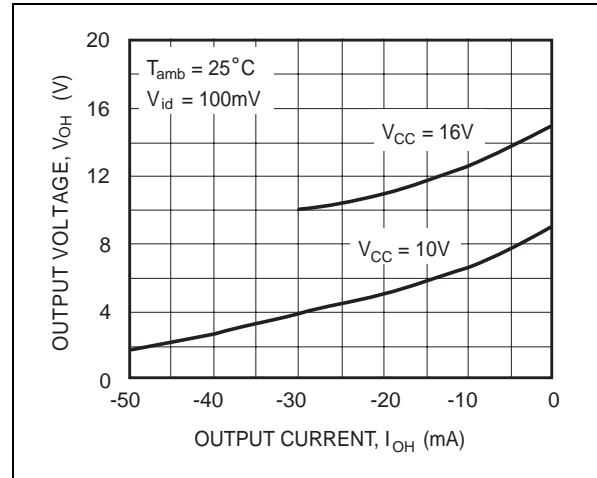

**Figure 14a :** Low Level Output Voltage versus Low Level Output Current

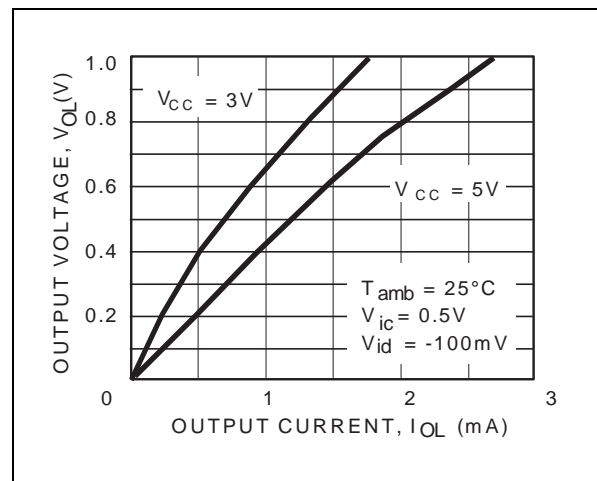

**Figure 14b :** Low Level Output Voltage versus Low Level Output Current

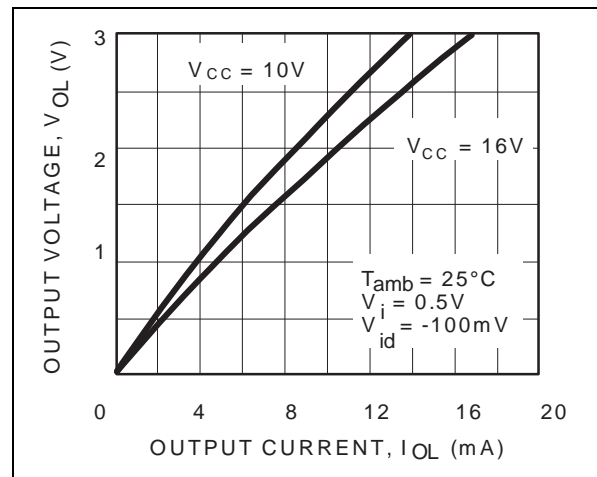

**Figure 15 : Open Loop Frequency Response and Phase Shift**

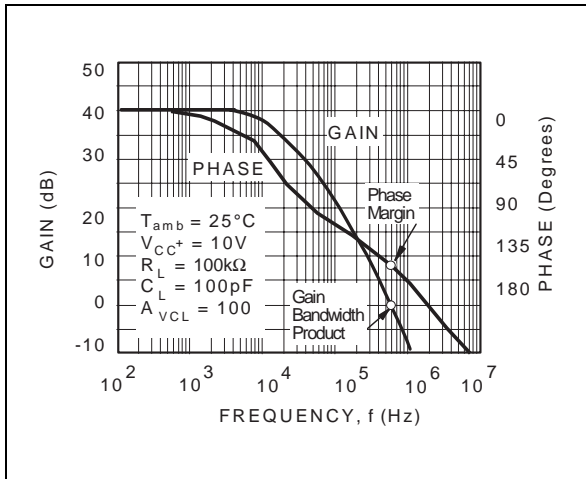

**Figure 16 : Gain Bandwidth Product versus Supply Voltage**

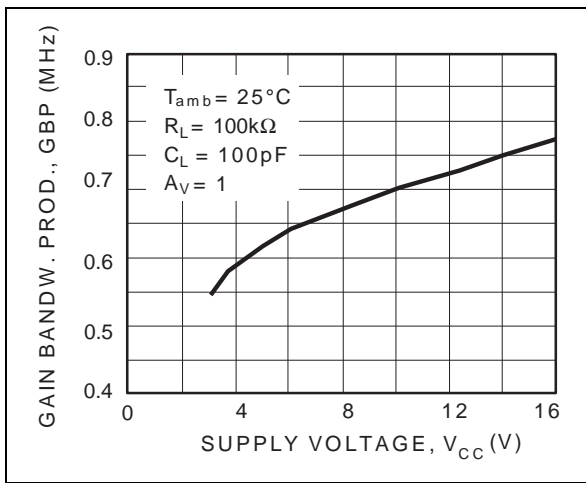

**Figure 17 : Phase Margin versus Supply Voltage**

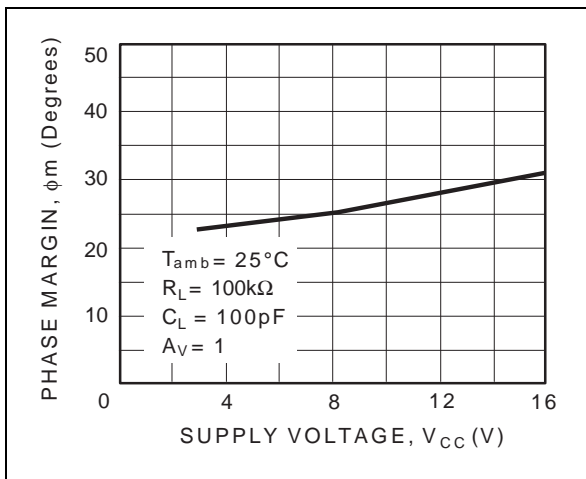

**Figure 18 : Phase Margin versus Capacitive Load**

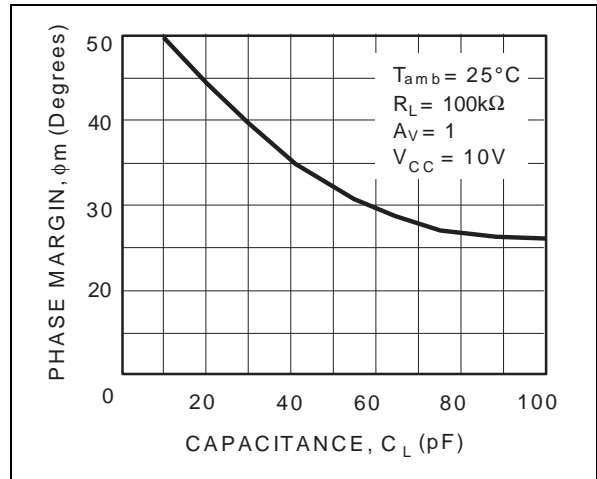

**Figure 19 : Slew Rate versus Supply Voltage**

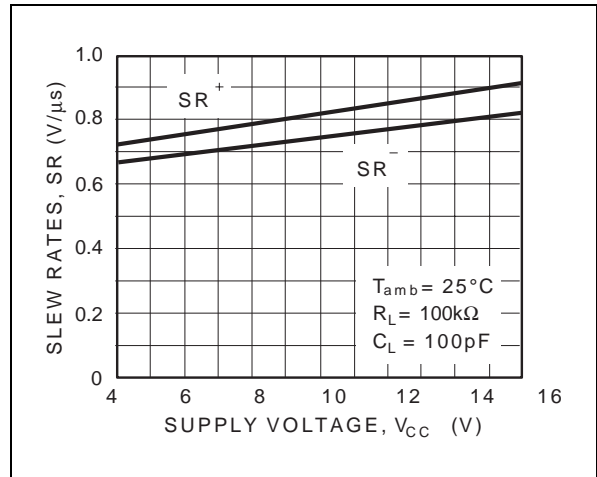

**ELECTRICAL CHARACTERISTICS for  $I_{SET} = 130\mu A$**  $V_{CC}^+ = +10V$ ,  $V_{CC}^- = 0V$ ,  $T_{amb} = +25^\circ C$  (unless otherwise specified)

Symbol	Parameter	TS271C/AC/BC			TS271I/AI/BI TS271M/AM/BM			Unit
		Min.	Typ.	Max.	Min.	Typ.	Max.	
$V_{io}$	Input Offset Voltage $V_O = 1.4V$ , $V_{ic} = 0V$		1.1	10		1.1	10	mV
	TS271C/I/M TS271AC/AI/AM TS271B/C/I/M		0.9 0.25	5 2		0.9 0.25	5 2	
	$T_{min} \leq T_{amb} \leq T_{max}$			12		12	12	
	TS271C/I/M TS271AC/AI/AM TS271B/C/I/M			6.5 3		6.5 3.5	6.5 3.5	
$DV_{io}$	Input Offset Voltage Drift		2			2		$\mu V/^\circ C$
$I_{io}$	Input Offset Current note <sup>1)</sup> $V_{ic} = 5V$ , $V_O = 5V$ $T_{min} \leq T_{amb} \leq T_{max}$		1	100		1	200	pA
$I_{ib}$	Input Bias Current - see note 1 $V_{ic} = 5V$ , $V_O = 5V$ $T_{min} \leq T_{amb} \leq T_{max}$		1	150		1	300	pA
$V_{OH}$	High Level Output Voltage $V_{id} = 100mV$ , $R_L = 10k\Omega$ $T_{min} \leq T_{amb} \leq T_{max}$	8.2 8.1	8.4		8.2 8	8.4		V
$V_{OL}$	Low Level Output Voltage $V_{id} = -100mV$			50			50	mV
$A_{vd}$	Large Signal Voltage Gain $V_{ic} = 5V$ , $R_L = 10k\Omega$ , $V_O = 1V$ to $6V$ $T_{min} \leq T_{amb} \leq T_{max}$	10 7	15		10 6	15		V/mV
GBP	Gain Bandwidth Product $A_v = 40dB$ , $R_L = 10k\Omega$ , $C_L = 100pF$ , $f_{in} = 100kHz$		2.3			2.3		MHz
CMR	Common Mode Rejection Ratio $V_{ic} = 1V$ to $7.4V$ , $V_O = 1.4V$	60	80		60	80		dB
SVR	Supply Voltage Rejection Ratio $V_{CC}^+ = 5V$ to $10V$ , $V_O = 1.4V$	60	70		60	70		dB
$I_{CC}$	Supply Current (per amplifier) $A_v = 1$ , no load, $V_O = 5V$ $T_{min} \leq T_{amb} \leq T_{max}$		800	1300 1400		800	1300 1500	$\mu A$
$I_o$	Output Short Circuit Current $V_O = 0V$ , $V_{id} = 100mV$		60			60		mA
$I_{sink}$	Output Sink Current $V_O = V_{CC}$ , $V_{id} = -100mV$		45			45		mA
SR	Slew Rate at Unity Gain $R_L = 10k\Omega$ , $C_L = 100pF$ , $V_i = 3$ to $7V$		4.5			4.5		V/ $\mu s$
$\phi_m$	Phase Margin at Unity Gain $A_v = 40dB$ , $R_L = 10k\Omega$ $C_L = 10pF$ $C_L = 100pF$		65 30			65 30		Degrees
$K_{OV}$	Overshoot Factor $A_v = 40dB$ , $R_L = 10k\Omega$ $C_L = 10pF$ $C_L = 100pF$		30 50			30 50		%
$e_n$	Equivalent Input Noise Voltage $f = 1kHz$ , $R_s = 100\Omega$		30			30		$\frac{nV}{\sqrt{Hz}}$

1. Maximum values including unavoidable inaccuracies of the industrial test.

TYPICAL CHARACTERISTICS for  $I_{SET} = 130\mu A$

Figure 20 : Supply Current (each amplifier) versus Supply Voltage

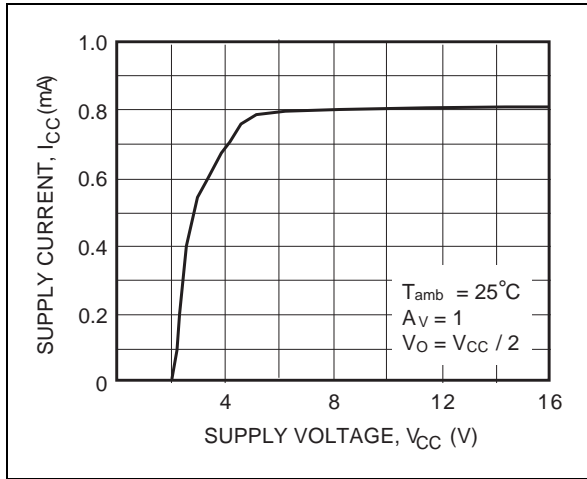

Figure 21 : Input Bias Current versus Free Air Temperature

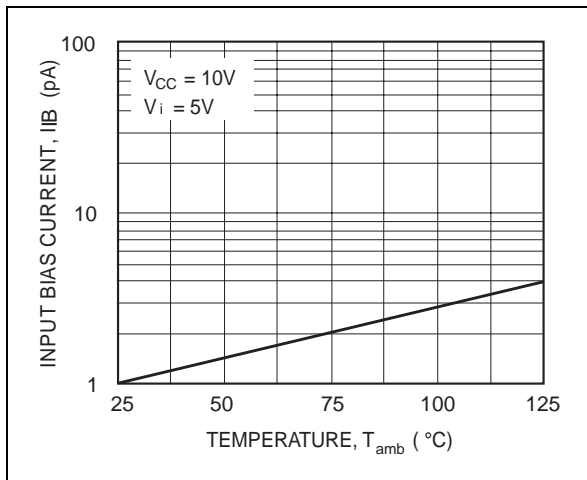

Figure 22a : High Level Output Voltage versus High Level Output Current

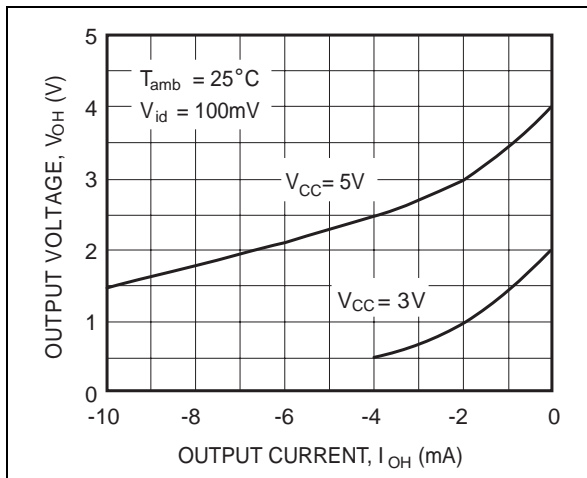

Figure 22b : High Level Output Voltage versus High Level Output Current

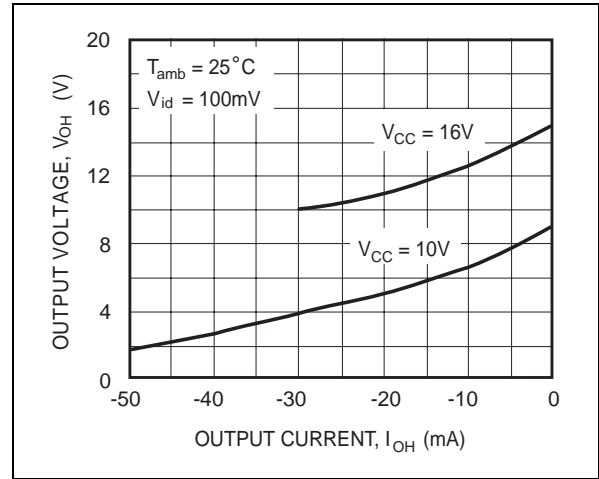

Figure 23a : Low Level Output Voltage versus Low Level Output Current

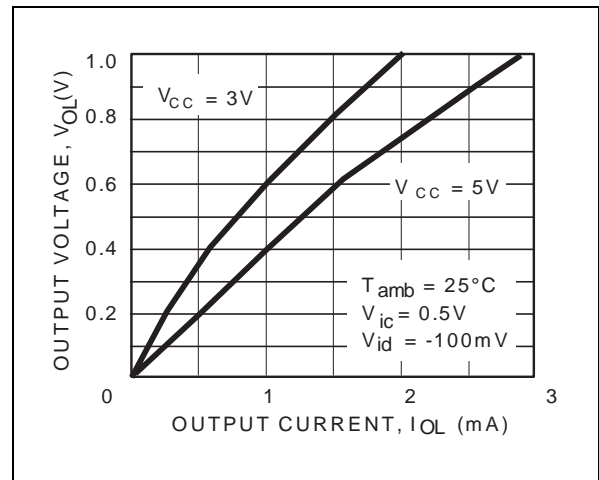
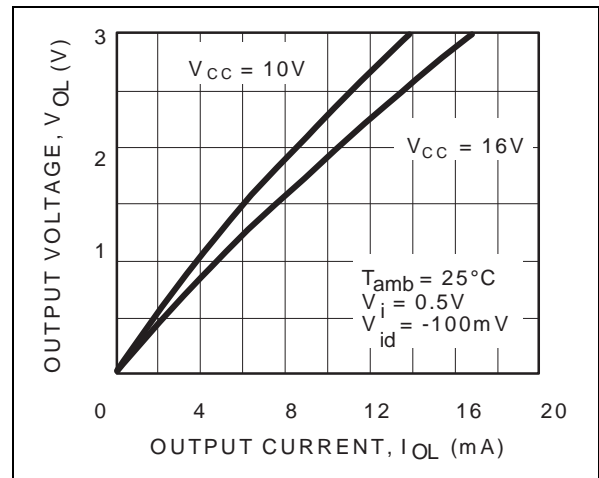
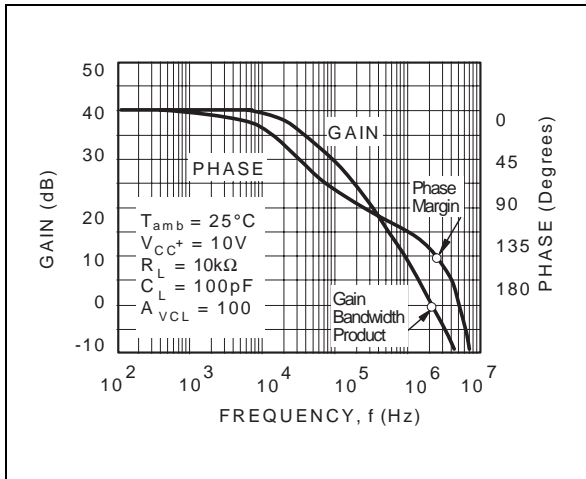

Figure 23b : Low Level Output Voltage versus Low Level Output Current



**Figure 24 :** Open Loop Frequency Response and Phase Shift



**Figure 25 :** Gain Bandwidth Product versus Supply Voltage

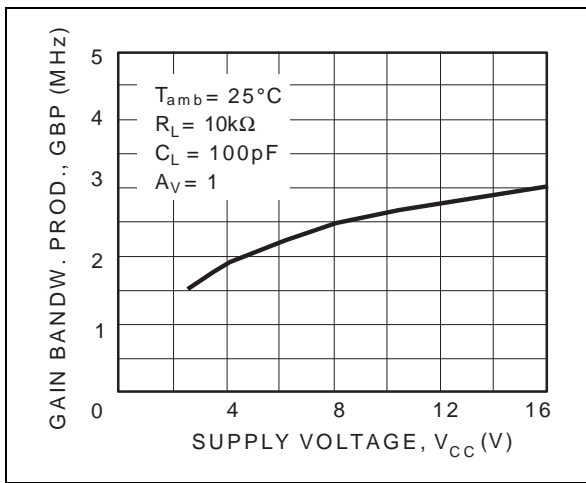

**Figure 26 :** Phase Margin versus Supply Voltage

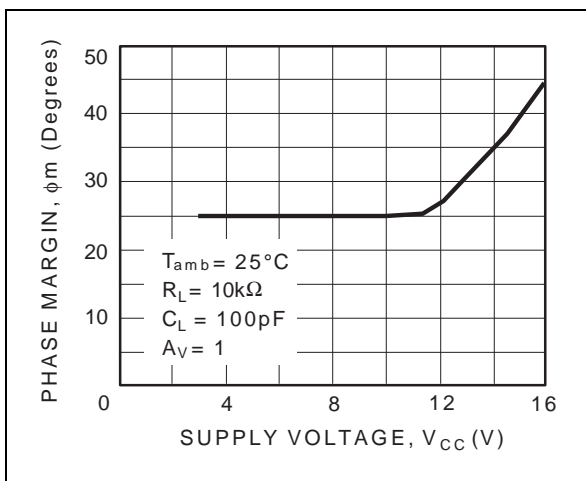

**Figure 27 :** Phase Margin versus Capacitive Load

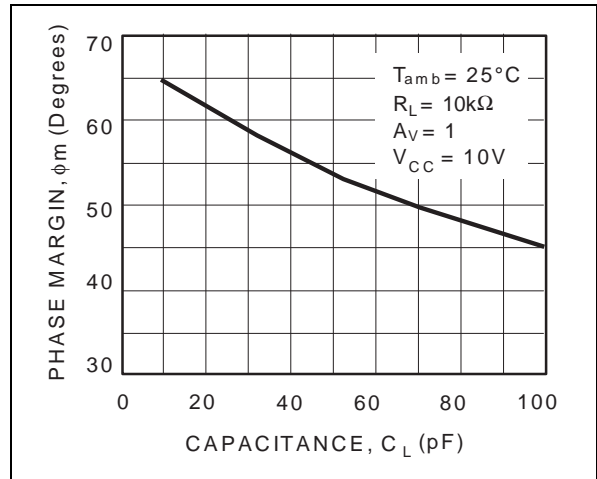

**Figure 28 :** Slew Rate versus Supply Voltage

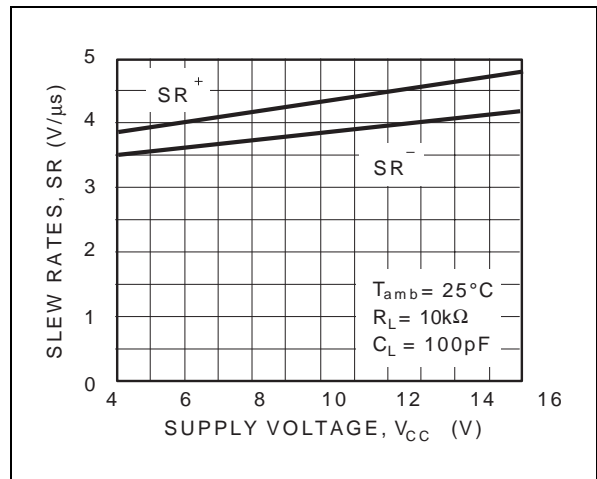

**PACKAGE MECHANICAL DATA**  
8 PINS - PLASTIC DIP

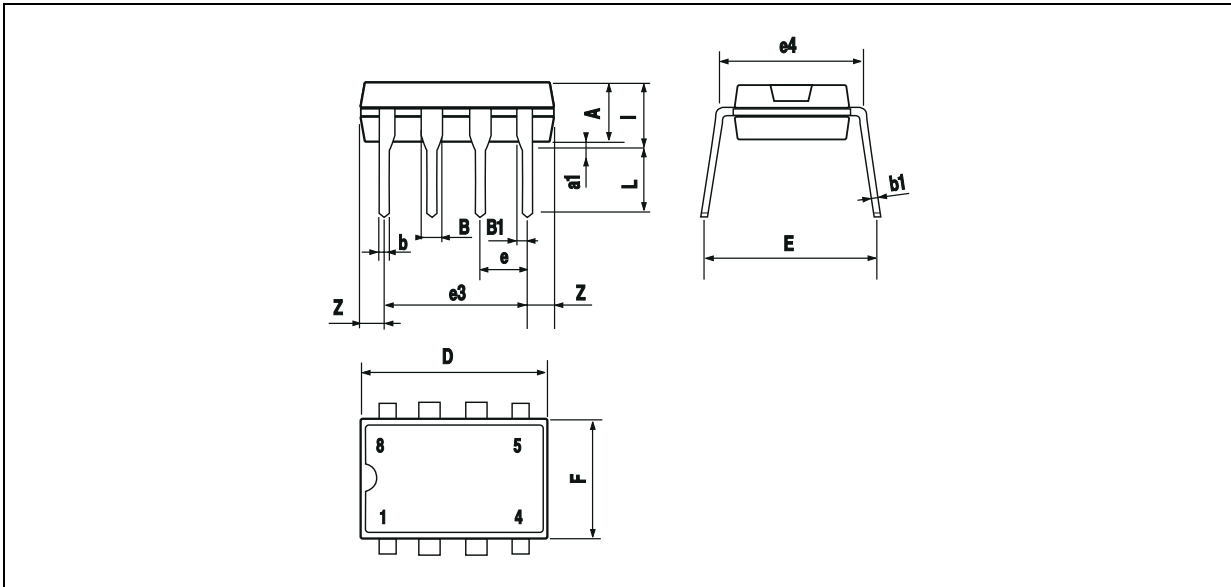

Dimensions	Millimeters			Inches		
	Min.	Typ.	Max.	Min.	Typ.	Max.
A		3.32			0.131	
a1	0.51			0.020		
B	1.15		1.65	0.045		0.065
b	0.356		0.55	0.014		0.022
b1	0.204		0.304	0.008		0.012
D			10.92			0.430
E	7.95		9.75	0.313		0.384
e		2.54			0.100	
e3		7.62			0.300	
e4		7.62			0.300	
F			6.6			0.260
i			5.08			0.200
L	3.18		3.81	0.125		0.150
Z			1.52			0.060

**PACKAGE MECHANICAL DATA**  
**8 PINS - PLASTIC MICROPACKAGE (SO)**

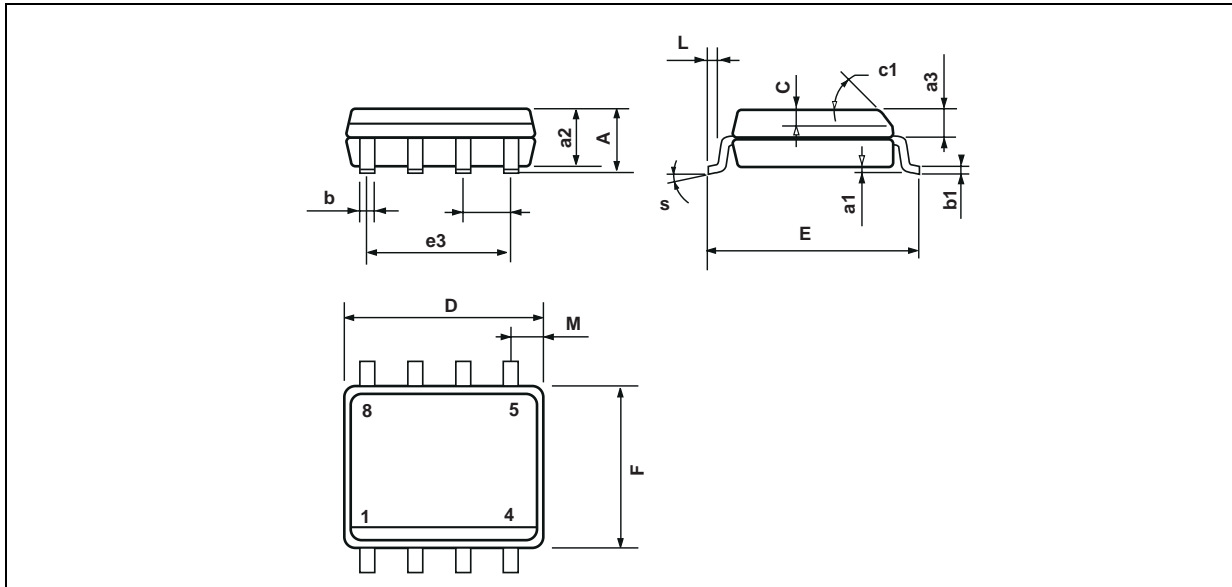

Dimensions	Millimeters			Inches		
	Min.	Typ.	Max.	Min.	Typ.	Max.
A			1.75			0.069
a1	0.1		0.25	0.004		0.010
a2			1.65			0.065
a3	0.65		0.85	0.026		0.033
b	0.35		0.48	0.014		0.019
b1	0.19		0.25	0.007		0.010
C	0.25		0.5	0.010		0.020
c1	45° (typ.)					
D	4.8		5.0	0.189		0.197
E	5.8		6.2	0.228		0.244
e		1.27			0.050	
e3		3.81			0.150	
F	3.8		4.0	0.150		0.157
L	0.4		1.27	0.016		0.050
M			0.6			0.024
S	8° (max.)					

Information furnished is believed to be accurate and reliable. However, STMicroelectronics assumes no responsibility for the consequences of use of such information nor for any infringement of patents or other rights of third parties which may result from its use. No license is granted by implication or otherwise under any patent or patent rights of STMicroelectronics. Specifications mentioned in this publication are subject to change without notice. This publication supersedes and replaces all information previously supplied. STMicroelectronics products are not authorized for use as critical components in life support devices or systems without express written approval of STMicroelectronics.

© The ST logo is a registered trademark of STMicroelectronics

© 2001 STMicroelectronics - Printed in Italy - All Rights Reserved  
 STMicroelectronics GROUP OF COMPANIES

Australia - Brazil - Canada - China - Finland - France - Germany - Hong Kong - India - Israel - Italy - Japan - Malaysia  
 Malta - Morocco - Singapore - Spain - Sweden - Switzerland - United Kingdom - United States

© <http://www.st.com>



This datasheet has been download from:

[www.datasheetcatalog.com](http://www.datasheetcatalog.com)

Datasheets for electronics components.