



LA2655V

Clear Sound Control IC Loading "Plus Sound[®]" Algorithm

Overview

The LA2655V is an IC for the sound replay which can be used for the audio equipment such as the radio cassette recorder, the personal computer, the stereo, and the television.

This IC has the function to replay a clear sound.

Features

Provides improved audio quality from one-way speaker systems by incorporating the SANYO algorithm "Plus Sound[®]", which corrects delay and attenuation differences between high and low frequencies due to the characteristics of the speaker.

Functions

- "Plus Sound[®]" algorithm provided on chip.
- Clear sound signal processing.
- Variable effect level (with external parts).
- Effect ON/OFF switch.

Package Dimensions

unit:mm

3179B-SSOP20

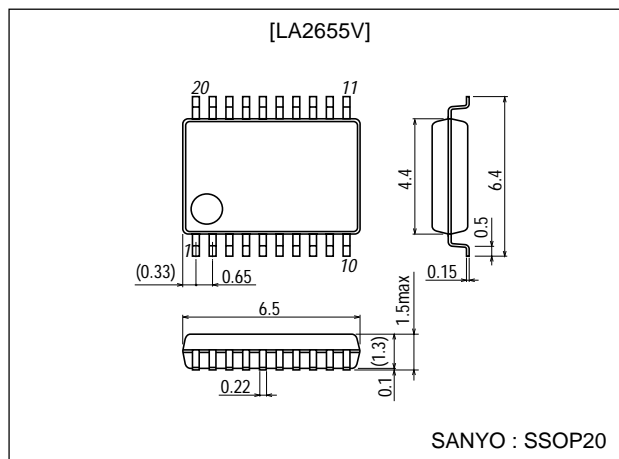

Specifications

Absolute Maximum Ratings at Ta = 25°C

Parameter	Symbol	Conditions	Ratings	Unit
Maximum supply voltage	V _{CC} max		13	V
Allowable power dissipation	Pd max	Ta ≤ 70°C	150	mW
Operating temperature	T _{opr}		-25 to +70	°C
Storage temperature	T _{stg}		-40 to +125	°C

Operating Conditions at Ta = 25°C

Parameter	Symbol	Conditions	Ratings	Unit
Recommended supply voltage	V _{CC}		9.0	V
Operating supply voltage range	V _{CC} op		4.5 to 12.0	V
Input high-level voltage	V _{IH}		2.5 to V _{CC}	V
Input low-level voltage	V _{IL}		0 to 1.5	V

■ Any and all SANYO products described or contained herein do not have specifications that can handle applications that require extremely high levels of reliability, such as life-support systems, aircraft's control systems, or other applications whose failure can be reasonably expected to result in serious physical and/or material damage. Consult with your SANYO representative nearest you before using any SANYO products described or contained herein in such applications.

■ SANYO assumes no responsibility for equipment failures that result from using products at values that exceed, even momentarily, rated values (such as maximum ratings, operating condition ranges, or other parameters) listed in products specifications of any and all SANYO products described or contained herein.

LA2655V

Electrical Characteristics at $T_a = 25^\circ\text{C}$, $V_{CC}=9\text{V}$, $f_m=1\text{kHz}$, $V_{in}=300\text{mV}_{rms}=0\text{dB}$, $R_L=10\text{k}\Omega$

Parameter	Symbol	Conditions	Ratings			Unit
			min	typ	max	
Quiescent current	I_{ccT}	No signal, bypass		5	10	mA
Output level deviation	VG T	Bypass	-2	0	+2	dB
	VG C	ON	-1	+1	+3	dB
Maximum output voltage	$V_{o\ max\ T}$	Bypass	1.5	2		Vrms
	$V_{o\ max\ C}$	ON	1.5	2		Vrms
Total harmonic distortion	THD T	Bypass		0.005	0.03	%
	THD C	ON		0.08	0.5	%
Output noise voltage	$V_{no\ T}$	Bypass		-95		dBm
	$V_{no\ C}$	ON		-85		dBm

Block Diagram

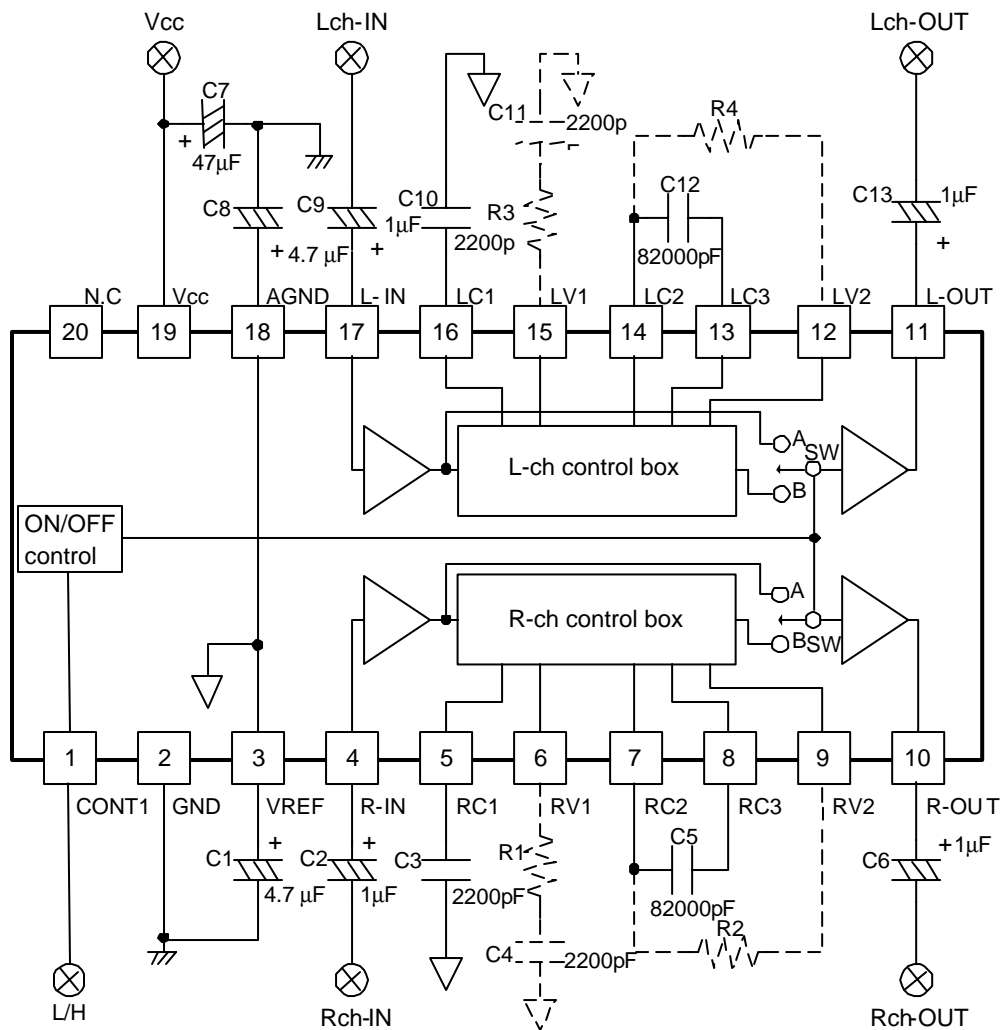

P1	Mode
L	I/O through effect
H	I/O through effect

High level	R1, R3	Remarks
Max	-	
Mid	18k Ω	
Min	11k Ω	

Low level	R2, R4	Remarks
Max	10k Ω	
Mid	24k Ω	
Min	-	

LA2655V

Pin Function

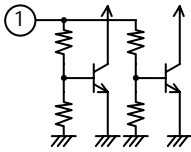
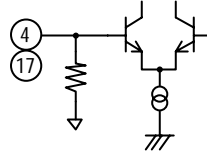
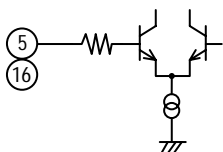
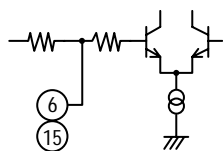
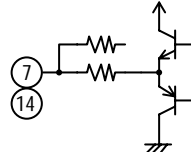
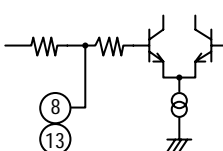
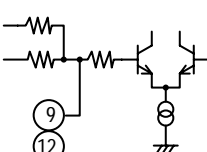
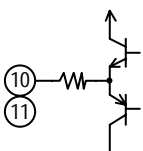
Pin No.	Pin Name	Pin Voltage	Description	Equivalent circuit
1	CONT1	0/5V		The function switching switch.
4 17	R-IN L-IN	$1/2V_{CC}$		The linear system input terminal.
5 16	RC1 LC1	$1/2V_{CC}$		The terminal which connects the capacitor which sets a phase shift position with the high frequency.
6 15	RV1 LV1	$1/2V_{CC}$		It connects resistance and a capacitor to amplify the high frequency.
7 14	RC2 LC2	$1/2V_{CC}$		The terminal which connects the capacitor which sets a phase shift position with the low frequency.
8 13	RC3 LC3	$1/2V_{CC}$		The terminal which connects the capacitor which sets a phase shift position with the low frequency.
9 12	RV2 LV2	$1/2V_{CC}$		It connects resistance and a capacitor to amplify the low frequency.
10 11	R-OUT L-OUT	$1/2V_{CC}$		The linear system output terminal.

- Specifications of any and all SANYO products described or contained herein stipulate the performance, characteristics, and functions of the described products in the independent state, and are not guarantees of the performance, characteristics, and functions of the described products as mounted in the customer's products or equipment. To verify symptoms and states that cannot be evaluated in an independent device, the customer should always evaluate and test devices mounted in the customer's products or equipment.
- SANYO Electric Co., Ltd. strives to supply high-quality high-reliability products. However, any and all semiconductor products fail with some probability. It is possible that these probabilistic failures could give rise to accidents or events that could endanger human lives, that could give rise to smoke or fire, or that could cause damage to other property. When designing equipment, adopt safety measures so that these kinds of accidents or events cannot occur. Such measures include but are not limited to protective circuits and error prevention circuits for safe design, redundant design, and structural design.
- In the event that any or all SANYO products(including technical data, services) described or contained herein are controlled under any of applicable local export control laws and regulations, such products must not be exported without obtaining the export license from the authorities concerned in accordance with the above law.
- No part of this publication may be reproduced or transmitted in any form or by any means, electronic or mechanical, including photocopying and recording, or any information storage or retrieval system, or otherwise, without the prior written permission of SANYO Electric Co., Ltd.
- Any and all information described or contained herein are subject to change without notice due to product/technology improvement, etc. When designing equipment, refer to the "Delivery Specification" for the SANYO product that you intend to use.
- Information (including circuit diagrams and circuit parameters) herein is for example only ; it is not guaranteed for volume production. SANYO believes information herein is accurate and reliable, but no guarantees are made or implied regarding its use or any infringements of intellectual property rights or other rights of third parties.

This catalog provides information as of July, 2001. Specifications and information herein are subject to change without notice.