

Optocoupler with Phototransistor Output

Description

The CNY75(G) series consists of a phototransistor optically coupled to a gallium arsenide infrared-emitting diode in a 6-lead plastic dual inline package. The elements are mounted on one leadframe using a **coplanar technique**, providing a fixed distance between input and output for highest safety requirements.

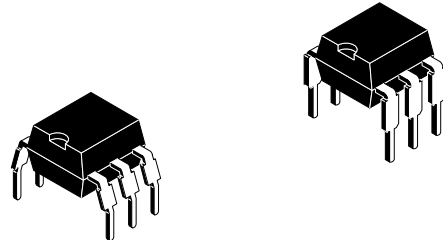

14827

Applications

Circuits for safe protective separation against electrical shock according to safety class II (reinforced isolation):

- For appl. class I – IV at mains voltage ≤ 300 V
- For appl. class I – III at mains voltage ≤ 600 V according to VDE 0884, table 2, suitable for:

Switch-mode power supplies, line receiver, computer peripheral interface, microprocessor system interface.

VDE Standards

These couplers perform safety functions according to the following equipment standards:

- **VDE 0884**
Optocoupler for electrical safety requirements
- **IEC 950/EN 60950**
Office machines (applied for reinforced isolation for mains voltage ≤ 400 V_{RMS})
- **VDE 0804**
Telecommunication apparatus and data processing
- **IEC 65**
Safety for mains-operated electronic and related household apparatus

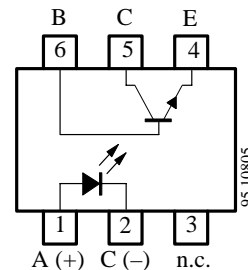

0884

Order Instruction

Ordering Code	CTR Ranking	Remarks
CNY75A/ CNY75GA ¹⁾	63 to 125%	
CNY75B/ CNY75GB ¹⁾	100 to 200%	
CNY75C/ CNY75GC ¹⁾	160 to 320%	
¹⁾ G = Leadform 10.16 mm; G is not marked on the body		



Features

Approvals:

- **BSI:** BS EN 41003, BS EN 60095 (BS 415), BS EN 60950 (BS 7002), Certificate number 7081 and 7402
- **FIMKO (SETI):** EN 60950, Certificate number 12399
- **Underwriters Laboratory (UL)** 1577 recognized, file number E-76222
- **VDE 0884**, Certificate number 94778

VDE 0884 related features:

- Rated impulse voltage (transient overvoltage) $V_{IOTM} = 6$ kV peak
- Isolation test voltage (partial discharge test voltage) $V_{pd} = 1.6$ kV
- Rated isolation voltage (RMS includes DC) $V_{IOWM} = 600$ V_{RMS} (848 V peak)

- Rated recurring peak voltage (repetitive) $V_{IORM} = 600$ V_{RMS}
- Creepage current resistance according to VDE 0303/IEC 112
Comparative Tracking Index: CTI = 275
- Thickness through insulation ≥ 0.75 mm

General features:

- Isolation materials according to UL94-VO
- Pollution degree 2 (DIN/VDE 0110 part 1 resp. IEC 664)
- Climatic classification 55/100/21 (IEC 68 part 1)
- Special construction: Therefore, extra low coupling capacity of typical 0.3 pF, high **Common Mode Rejection**
- Low temperature coefficient of CTR
- CTR offered in 3 groups
- Coupling System A

Absolute Maximum Ratings

Input (Emitter)

Parameter	Test Conditions	Symbol	Value	Unit
Reverse voltage		V_R	5	V
Forward current		I_F	60	mA
Forward surge current	$t_p \leq 10 \mu s$	I_{FSM}	3	A
Power dissipation	$T_{amb} \leq 25^\circ C$	P_V	100	mW
Junction temperature		T_j	125	$^\circ C$

Output (Detector)

Parameter	Test Conditions	Symbol	Value	Unit
Collector base voltage		V_{CBO}	90	V
Collector emitter voltage		V_{CEO}	90	V
Emitter collector voltage		V_{ECO}	7	V
Collector current		I_C	50	mA
Collector peak current	$t_p/T = 0.5, t_p \leq 10$ ms	I_{CM}	100	mA
Power dissipation	$T_{amb} \leq 25^\circ C$	P_V	150	mW
Junction temperature		T_j	125	$^\circ C$

Coupler

Parameter	Test Conditions	Symbol	Value	Unit
AC isolation test voltage (RMS)	$t = 1$ min	V_{IO}	3.75	kV
Total power dissipation	$T_{amb} \leq 25^\circ C$	P_{tot}	250	mW
Ambient temperature range		T_{amb}	-55 to +100	$^\circ C$
Storage temperature range		T_{stg}	-55 to +125	$^\circ C$
Soldering temperature	2 mm from case, $t \leq 10$ s	T_{sd}	260	$^\circ C$

**Electrical Characteristics** ($T_{amb} = 25^{\circ}\text{C}$)

Input (Emitter)

Parameter	Test Conditions	Symbol	Min.	Typ.	Max.	Unit
Forward voltage	$I_F = 50\text{ mA}$	V_F		1.25	1.6	V
Reverse current	$V_R = 6\text{ V}$	I_R			10	μA
Junction capacitance	$V_R = 0, f = 1\text{ MHz}$	C_j		50		pF

Output (Detector)

Parameter	Test Conditions	Symbol	Min.	Typ.	Max.	Unit
Collector base voltage	$I_C = 100\ \mu\text{A}$	V_{CB0}	90			V
Collector emitter voltage	$I_C = 1\text{ mA}$	V_{CEO}	90			V
Emitter collector voltage	$I_E = 100\ \mu\text{A}$	V_{ECO}	7			V
Collector emitter cut-off current	$V_{CE} = 20\text{ V}, I_F = 0$	I_{CEO}			150	nA

Coupler

Parameter	Test Conditions	Symbol	Min.	Typ.	Max.	Unit
Collector emitter saturation voltage	$I_F = 10\text{ mA}, I_C = 1\text{ mA}$	V_{CEsat}			0.3	V
Cut-off frequency	$V_{CE} = 5\text{ V}, I_F = 10\text{ mA}, R_L = 100\ \Omega$	f_c		110		kHz
Coupling capacitance	$f = 1\text{ MHz}$	C_k		0.3		pF

Current Transfer Ratio (CTR)

Parameter	Test Conditions	Type	Symbol	Min.	Typ.	Max.	Unit
I_C/I_F	$V_{CE} = 5\text{ V}, I_F = 1\text{ mA}$	CNY75(G)A	CTR	0.15			
		CNY75(G)B	CTR	0.3			
		CNY75(G)C	CTR	0.6			
	$V_{CE} = 5\text{ V}, I_F = 10\text{ mA}$	CNY75(G)A	CTR	0.63		1.25	
		CNY75(G)B	CTR	1		2	
		CNY75(G)C	CTR	1.6		3.2	

Maximum Safety Ratings (according to VDE 0884) see figure 1

This device is used for protective separation against electrical shock only within the maximum safety ratings. This must be ensured by using protective circuits in the applications.

Input (Emitter)

Parameters	Test Conditions	Symbol	Value	Unit
Forward current		I_{si}	130	mA

Output (Detector)

Parameters	Test Conditions	Symbol	Value	Unit
Power dissipation	$T_{amb} \leq 25^\circ\text{C}$	P_{si}	265	mW

Coupler

Parameters	Test Conditions	Symbol	Value	Unit
Rated impulse voltage		V_{IOTM}	6	kV
Safety temperature		T_{si}	150	$^\circ\text{C}$

Insulation Rated Parameters (according to VDE 0884)

Parameter	Test Conditions	Symbol	Min.	Typ.	Max.	Unit
Partial discharge test voltage – Routine test	100%, $t_{test} = 1\text{ s}$	V_{pd}	1.6			kV
Partial discharge test voltage – Lot test (sample test)	$t_{Tr} = 60\text{ s}$, $t_{test} = 10\text{ s}$, (see figure 2)	V_{IOTM}	6			kV
		V_{pd}	1.3			kV
Insulation resistance	$V_{IO} = 500\text{ V}$	R_{IO}	10^{12}			Ω
	$V_{IO} = 500\text{ V}$, $T_{amb} \leq 100^\circ\text{C}$	R_{IO}	10^{11}			Ω
	$V_{IO} = 500\text{ V}$, $T_{amb} \leq 150^\circ\text{C}$ (construction test only)	R_{IO}	10^9			Ω

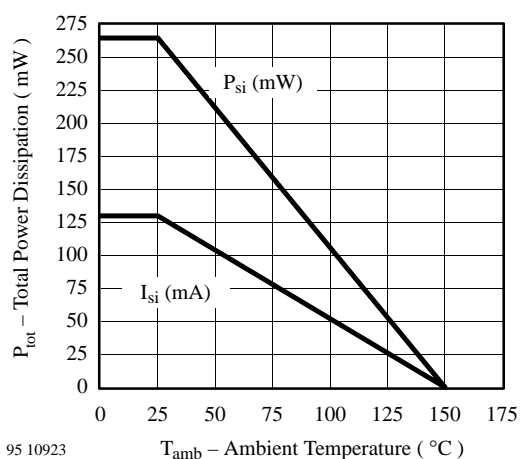

Figure 1. Derating diagram

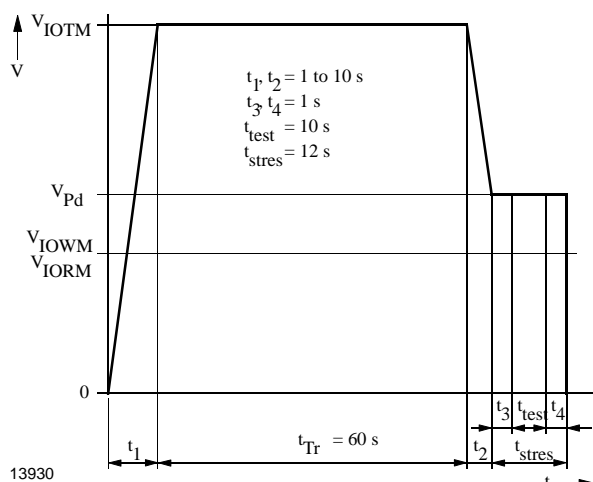

Figure 2. Test pulse diagram for sample test according to DIN VDE 0884

**Switching Characteristics of CNY75(G)A**

Parameter	Test Conditions	Symbol	Typ.	Unit
Delay time	$V_S = 5\text{ V}$, $I_C = 10\text{ mA}$, $R_L = 100\ \Omega$ (see figure 3)	t_d	2.0	μs
Rise time		t_r	2.5	μs
Fall time		t_f	2.7	μs
Storage time		t_s	0.3	μs
Turn-on time		t_{on}	4.5	μs
Turn-off time		t_{off}	3.0	μs
Turn-on time	$V_S = 5\text{ V}$, $I_F = 10\text{ mA}$, $R_L = 1\text{ k}\Omega$ (see figure 4)	t_{on}	10.0	μs
Turn-off time		t_{off}	25.0	μs

Switching Characteristics of CNY75(G)B

Parameter	Test Conditions	Symbol	Typ.	Unit
Delay time	$V_S = 5\text{ V}$, $I_C = 10\text{ mA}$, $R_L = 100\ \Omega$ (see figure 3)	t_d	2.5	μs
Rise time		t_r	3.0	μs
Fall time		t_f	3.7	μs
Storage time		t_s	0.3	μs
Turn-on time		t_{on}	5.5	μs
Turn-off time		t_{off}	4.0	μs
Turn-on time	$V_S = 5\text{ V}$, $I_F = 10\text{ mA}$, $R_L = 1\text{ k}\Omega$ (see figure 4)	t_{on}	16.5	μs
Turn-off time		t_{off}	20	μs

Switching Characteristics of CNY75(G)C

Parameter	Test Conditions	Symbol	Typ.	Unit
Delay time	$V_S = 5\text{ V}$, $I_C = 10\text{ mA}$, $R_L = 100\ \Omega$ (see figure 3)	t_d	2.8	μs
Rise time		t_r	4.2	μs
Fall time		t_f	4.7	μs
Storage time		t_s	0.3	μs
Turn-on time		t_{on}	7.0	μs
Turn-off time		t_{off}	5.0	μs
Turn-on time	$V_S = 5\text{ V}$, $I_F = 10\text{ mA}$, $R_L = 1\text{ k}\Omega$ (see figure 4)	t_{on}	11	μs
Turn-off time		t_{off}	37.5	μs

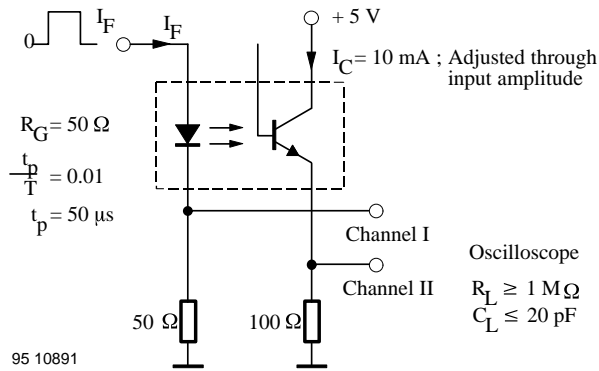

Figure 3. Test circuit, non-saturated operation

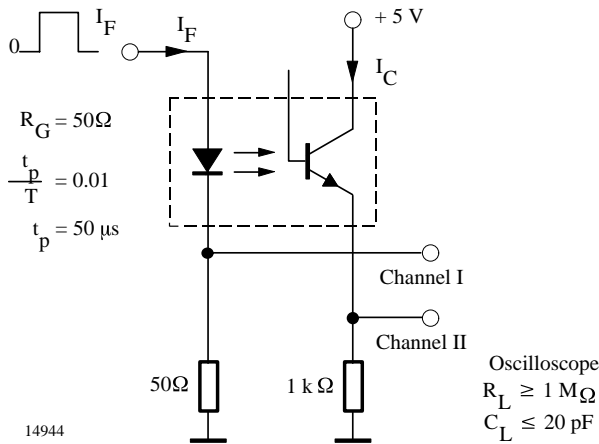

Figure 4. Test circuit, saturated operation

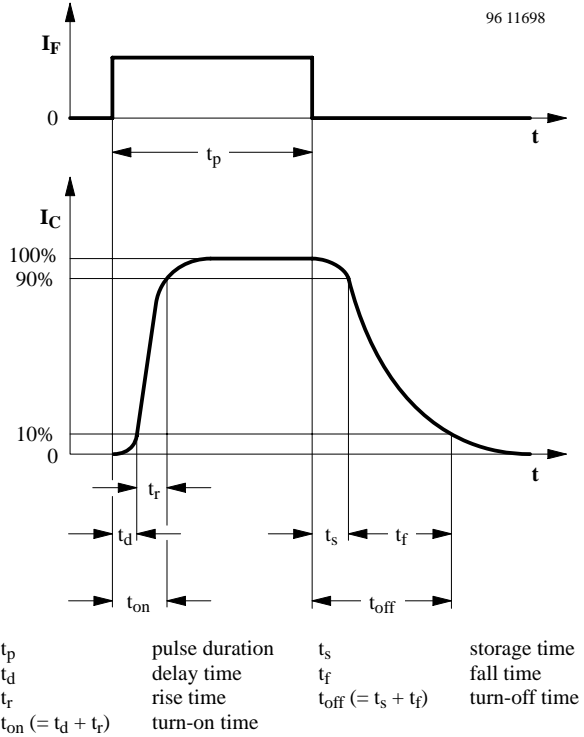

Figure 5. Switching times

Typical Characteristics ($T_{amb} = 25^{\circ}\text{C}$, unless otherwise specified)

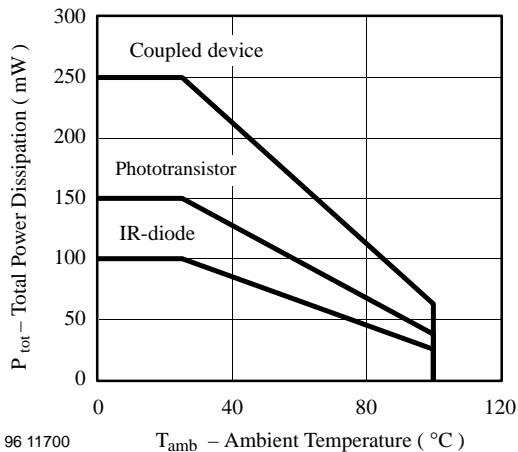

Figure 6. Total Power Dissipation vs. Ambient Temperature

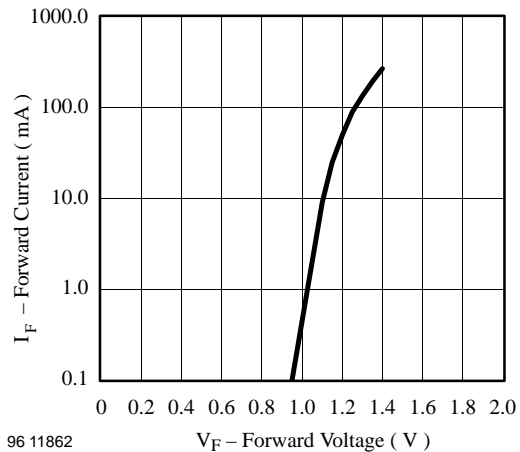

Figure 7. Forward Current vs. Forward Voltage

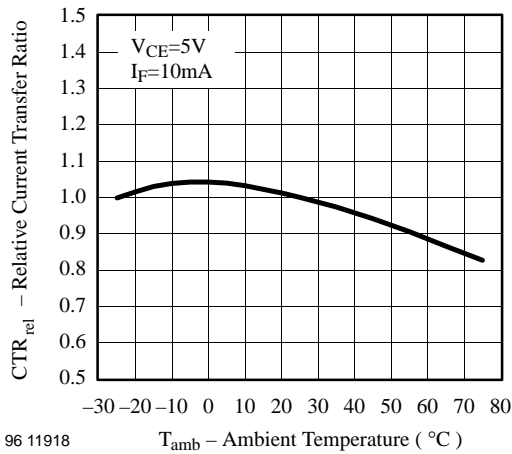

Figure 8. Relative Current Transfer Ratio vs. Ambient Temperature

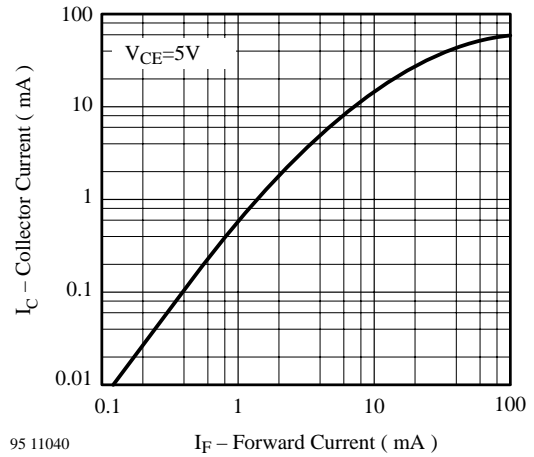

Figure 11. Collector Current vs. Forward Current

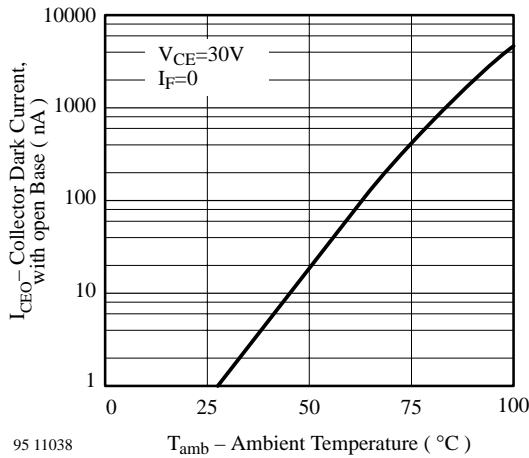

Figure 9. Collector Dark Current vs. Ambient Temperature

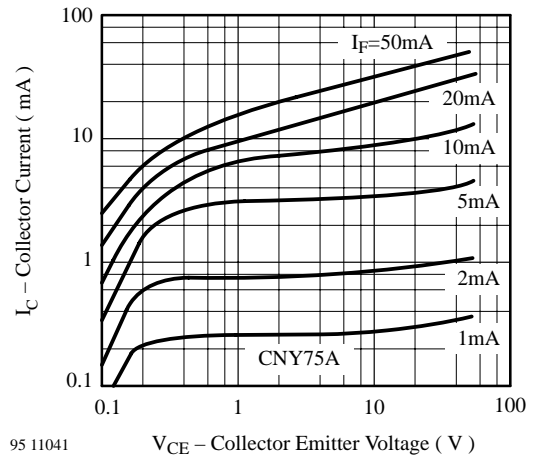

Figure 12. Collector Current vs. Collector Emitter Voltage

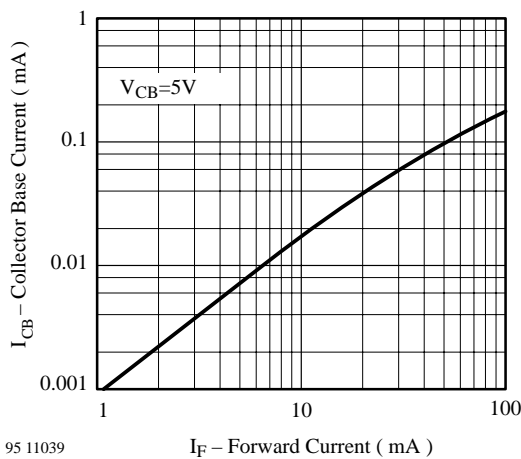

Figure 10. Collector Base Current vs. Forward Current

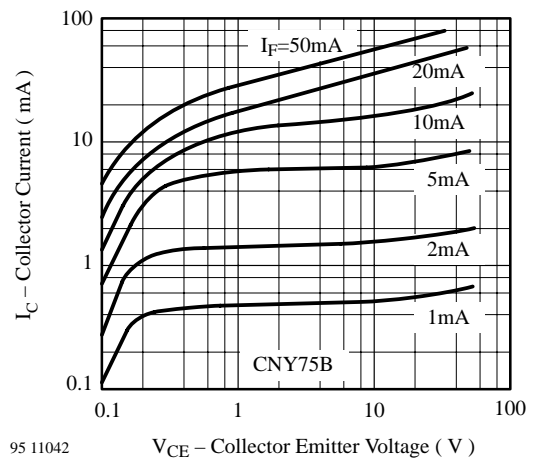
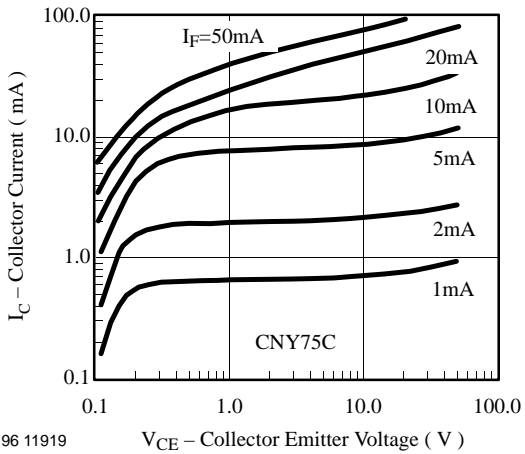
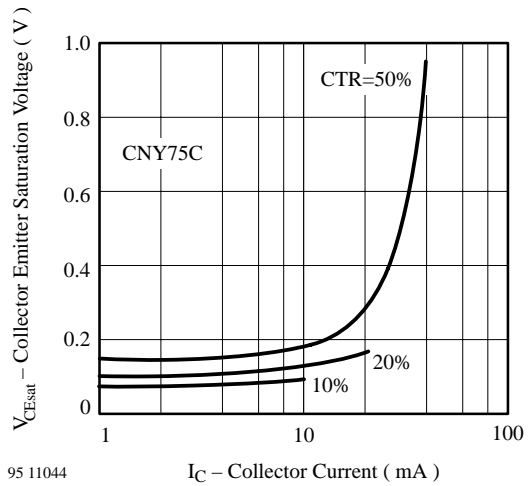

Figure 13. Collector Current vs. Collector Emitter Voltage



96 11919 V_{CE} – Collector Emitter Voltage (V)
 Figure 14. Collector Current vs. Collector Emitter Voltage



95 11044 V_{CESat} – Collector Emitter Saturation Voltage (V)
 I_C – Collector Current (mA)
 Figure 17. Coll. Emitter Sat. Voltage vs. Coll. Current

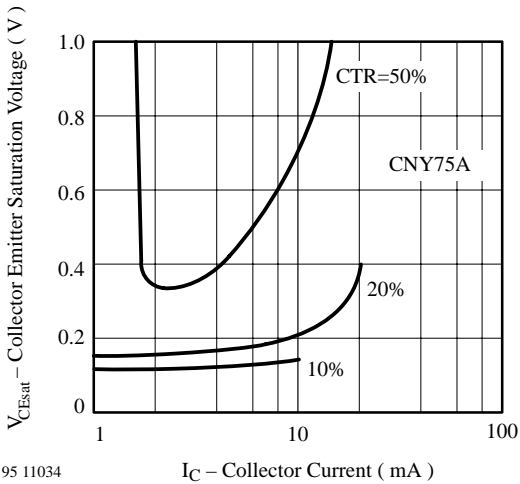

95 11034 V_{CESat} – Collector Emitter Saturation Voltage (V)
 I_C – Collector Current (mA)
 Figure 15. Coll. Emitter Sat. Voltage vs. Coll. Current

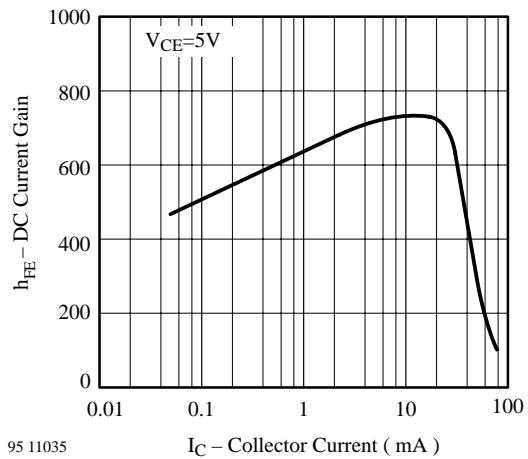

95 11035 h_{FE} – DC Current Gain
 I_C – Collector Current (mA)
 Figure 18. DC Current Gain vs. Collector Current

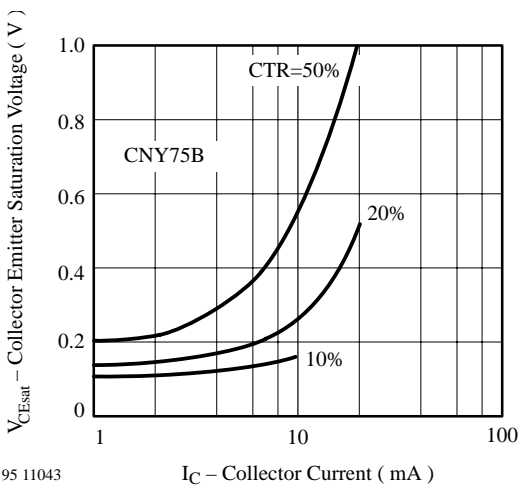

95 11043 V_{CESat} – Collector Emitter Saturation Voltage (V)
 I_C – Collector Current (mA)
 Figure 16. Coll. Emitter Sat. Voltage vs. Coll. Current

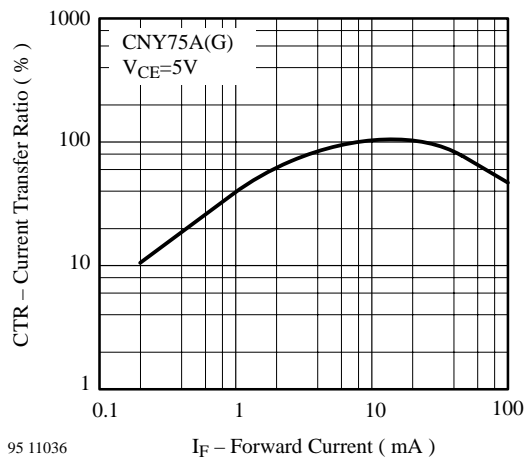

95 11036 CTR – Current Transfer Ratio (%)
 I_F – Forward Current (mA)
 Figure 19. Current Transfer Ratio vs. Forward Current

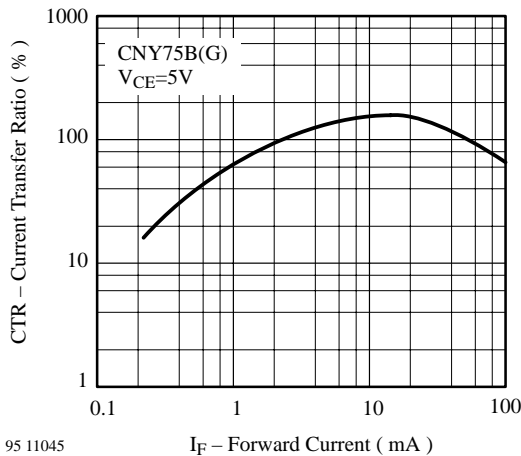

Figure 20. Current Transfer Ratio vs. Forward Current

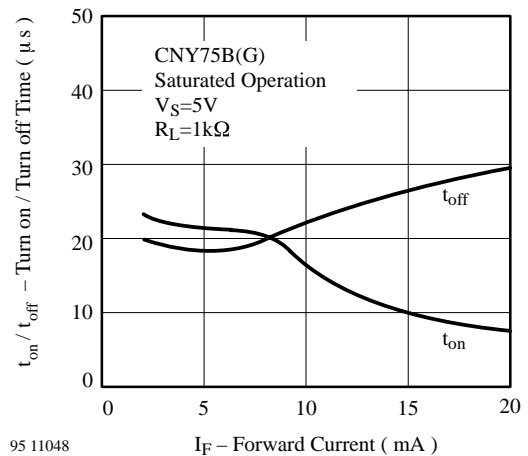

Figure 23. Turn on / off Time vs. Forward Current

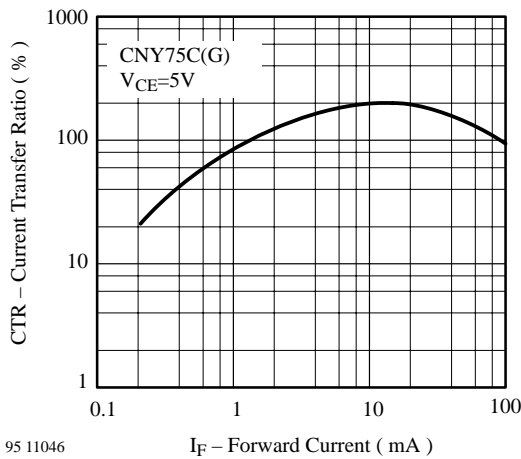

Figure 21. Current Transfer Ratio vs. Forward Current

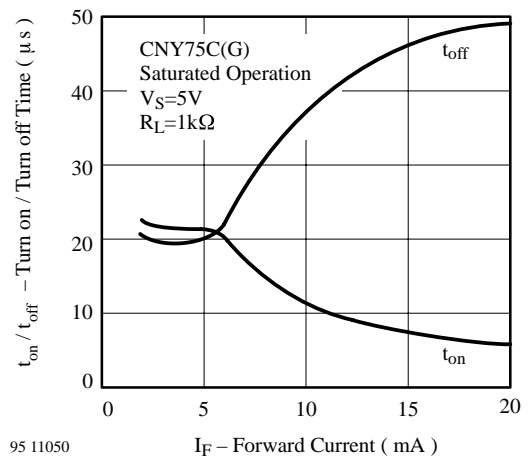

Figure 24. Turn on / off Time vs. Forward Current

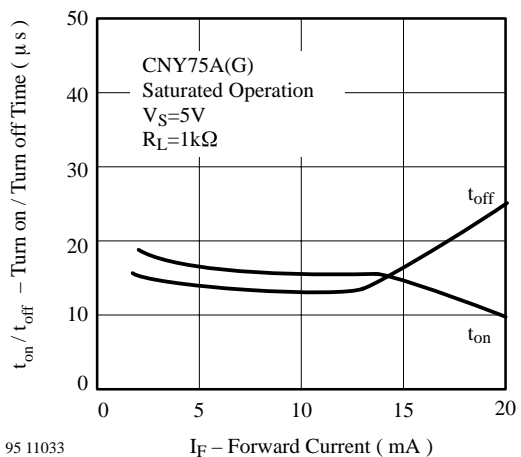

Figure 22. Turn on / off Time vs. Forward Current

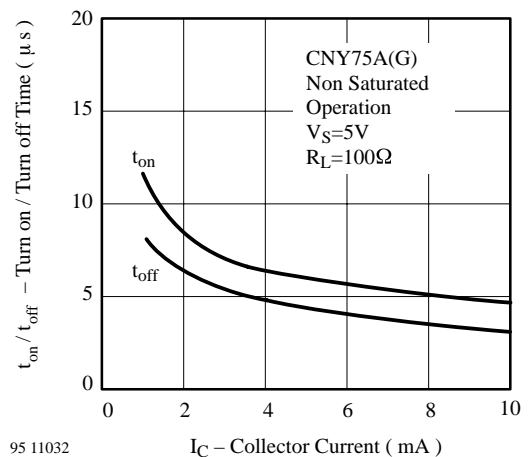
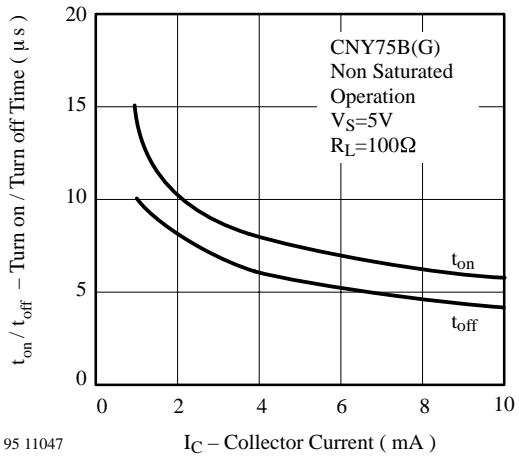
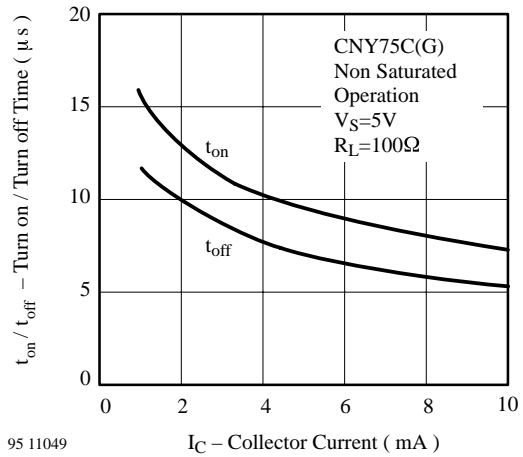

Figure 25. Turn on / off Time vs. Collector Current



95 11047

Figure 26. Turn on / off Time vs. Collector Current



95 11049

Figure 27. Turn on / off Time vs. Collector Current

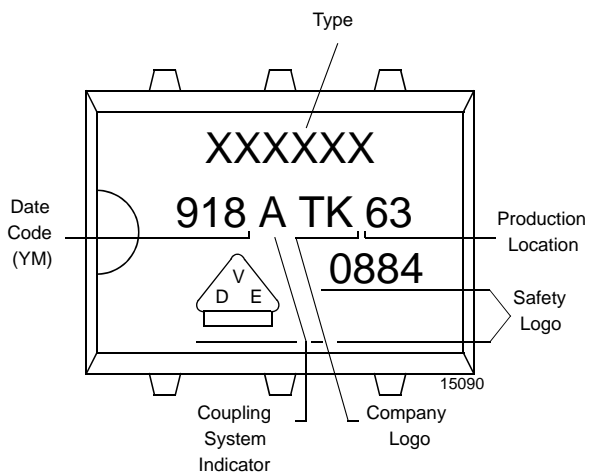
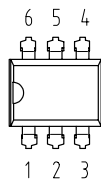
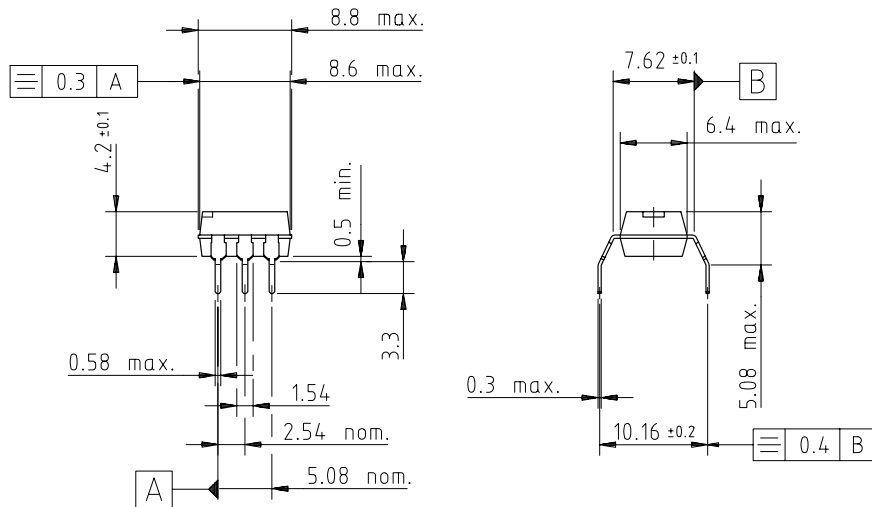

Figure 28. Marking example

Dimensions of CNY75G in mm



weight: ca. 0.50 g
 creepage distance: \cong 8 mm
 air path: \cong 8 mm

after mounting on PC board

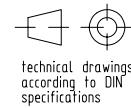

14771

Dimensions of CNY75 in mm

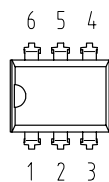
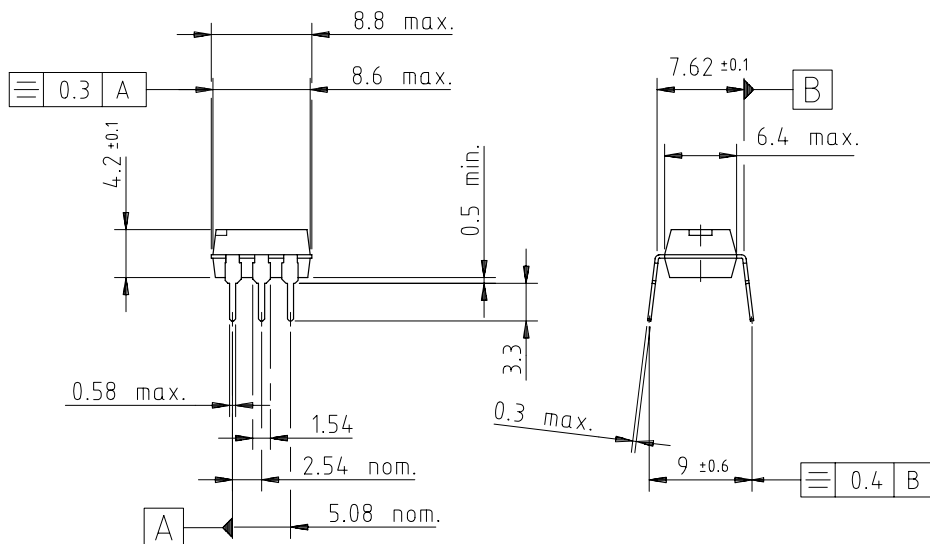

weight: 0.50 g
 creepage distance: \cong 6 mm
 air path: \cong 6 mm

after mounting on PC board

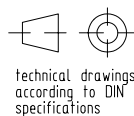

14770



Ozone Depleting Substances Policy Statement

It is the policy of **Vishay Semiconductor GmbH** to

1. Meet all present and future national and international statutory requirements.
2. Regularly and continuously improve the performance of our products, processes, distribution and operating systems with respect to their impact on the health and safety of our employees and the public, as well as their impact on the environment.

It is particular concern to control or eliminate releases of those substances into the atmosphere which are known as ozone depleting substances (ODSs).

The Montreal Protocol (1987) and its London Amendments (1990) intend to severely restrict the use of ODSs and forbid their use within the next ten years. Various national and international initiatives are pressing for an earlier ban on these substances.

Vishay Semiconductor GmbH has been able to use its policy of continuous improvements to eliminate the use of ODSs listed in the following documents.

1. Annex A, B and list of transitional substances of the Montreal Protocol and the London Amendments respectively
2. Class I and II ozone depleting substances in the Clean Air Act Amendments of 1990 by the Environmental Protection Agency (EPA) in the USA
3. Council Decision 88/540/EEC and 91/690/EEC Annex A, B and C (transitional substances) respectively.

Vishay Semiconductor GmbH can certify that our semiconductors are not manufactured with ozone depleting substances and do not contain such substances.

We reserve the right to make changes to improve technical design and may do so without further notice.

Parameters can vary in different applications. All operating parameters must be validated for each customer application by the customer. Should the buyer use Vishay Telefunken products for any unintended or unauthorized application, the buyer shall indemnify Vishay Telefunken against all claims, costs, damages, and expenses, arising out of, directly or indirectly, any claim of personal damage, injury or death associated with such unintended or unauthorized use.

Vishay Semiconductor GmbH, P.O.B. 3535, D-74025 Heilbronn, Germany
Telephone: 49 (0)7131 67 2831, Fax number: 49 (0)7131 67 2423