



LB1645N

Bidirectional Motor Driver

Overview

The LB1645N is a bidirectional motor driver IC. Since it has a 2-input logic circuit and performs the function of bidirectional driving and braking, it is capable of direct driving 6V, 9V, 12V motors. The output voltage can be varied by using an external Zener diode.

Features

- 2-input logic can be used to exercise control of bidirectional driving and braking.
- On-chip elements to absorb dash current of motor.
- Input connectable direct to MOS LSI.
- Output voltage variable by use of external Zener diode.

Specifications

Absolute Maximum Ratings at $T_a = 25^\circ\text{C}$

Parameter	Symbol	Conditions	Ratings	Unit
Maximum supply voltage	$V_{CC\text{ max}}$		18	V
Input voltage	V_{IN}		-0.3 to V_{CC}	V
Output current	I_{OUT}		± 1.6	A
Allowable power dissipation	$P_d\text{ max}$		2.2	W
Operating temperature	T_{opr}		-25 to +75	$^\circ\text{C}$
Storage temperature	T_{stg}		-55 to +125	$^\circ\text{C}$

Allowable Operating Conditions at $T_a = 25^\circ\text{C}$

Parameter	Symbol	Conditions	Ratings	Unit
Supply voltage	V_{CC1}		7 to 18	V
	V_{CC2}		5 to 18	V

Package Dimensions

unit:mm

3046B-SIP10F

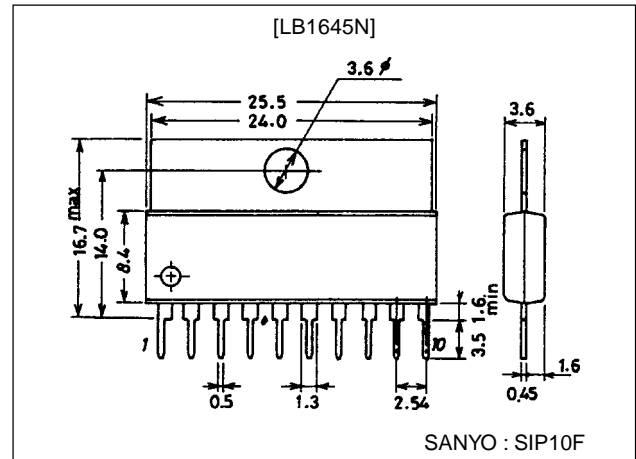

■ Any and all SANYO products described or contained herein do not have specifications that can handle applications that require extremely high levels of reliability, such as life-support systems, aircraft's control systems, or other applications whose failure can be reasonably expected to result in serious physical and/or material damage. Consult with your SANYO representative nearest you before using any SANYO products described or contained herein in such applications.

■ SANYO assumes no responsibility for equipment failures that result from using products at values that exceed, even momentarily, rated values (such as maximum ratings, operating condition ranges, or other parameters) listed in products specifications of any and all SANYO products described or contained herein.

SANYO Electric Co., Ltd. Semiconductor Business Headquarters

TOKYO OFFICE Tokyo Bldg., 1-10, 1 Chome, Ueno, Taito-ku, TOKYO, 110-8534 JAPAN

83198HA (KT)/N3093TS/8297KI/N224MW/D143KI/6073KI, TS No.1371-1/4

LB1645N

Electrical Characteristics at $T_a = 25^\circ\text{C}$, $V_{CC}=12\text{V}$, See Test Circuit.

Parameter	Symbol	Conditions	Ratings			Unit
			min	typ	max	
Input threshold voltage	V_{th}	$R_L=\infty$	1.1	1.3	1.5	V
Mimimum input on current	I_{IN}	$R_L=\infty$		10	15	μA
Output voltage	V_O	$R_L=60\Omega$, $V_Z=7.4\text{V}$	6.6	7.2	7.4	V
Output leakage current	I_{OL}	Pins5, 6 GND, $R_L=\infty$		0.01	1.0	mA
Current drain	I_{CC}	Pins5, 6 GND, $R_L=\infty$	3	6	10	mA
Saturation vottage (upper)	V_{sat1}	$V_{CC}=12\text{V}$, $I_{OUT}=300\text{mA}$		1.9	2.2	V
	V_{sat1}'	$V_{CC}=12\text{V}$, $I_{OUT}=500\text{mA}$		1.9	2.3	V
Saturation vottage (lower)	V_{sat2}	$V_{CC}=12\text{V}$, $I_{OUT}=300\text{mA}$		0.25	0.5	V
	V_{sat2}'	$V_{CC}=12\text{V}$, $I_{OUT}=500\text{mA}$		0.4	0.65	V

Truth Table

Input		Output		Function
IN1	IN2	OUT1	OUT2	
0	0	0	0	Braking
1	0	1	0	Forward (reverse) drive
0	1	0	1	Reverse (forward) drive
1	1	0	0	Braking

Input level
1 : 2.0V or more
0 : 0.7V or less

Test Circuit

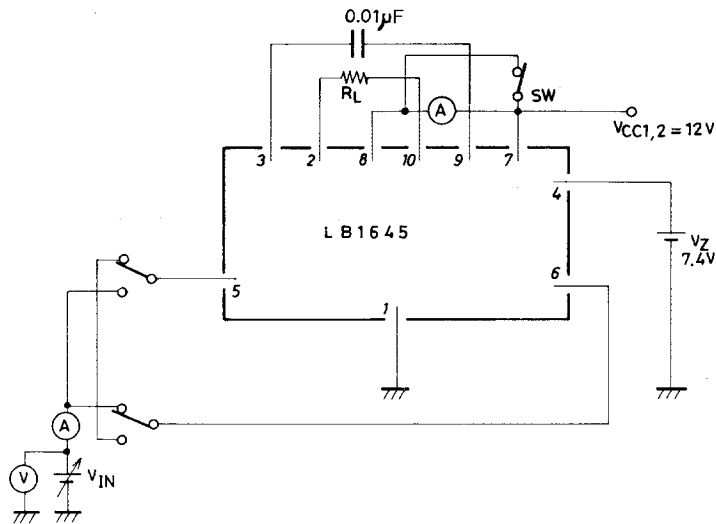

Sample Application Circuit : 6V motor

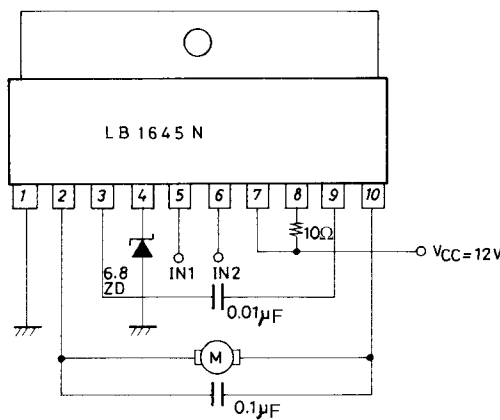

LB1645N

Equivalent Circuit Block Diagram

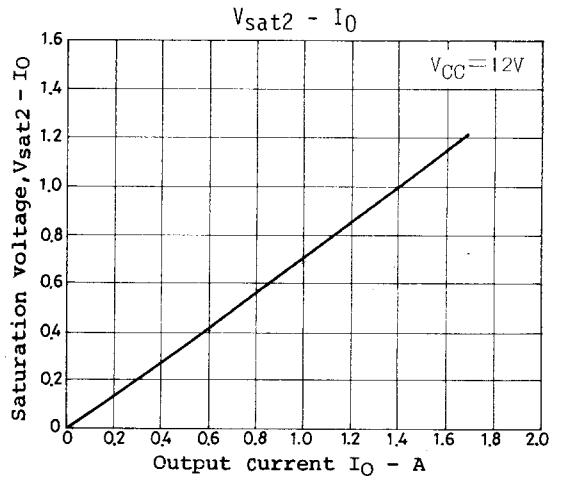
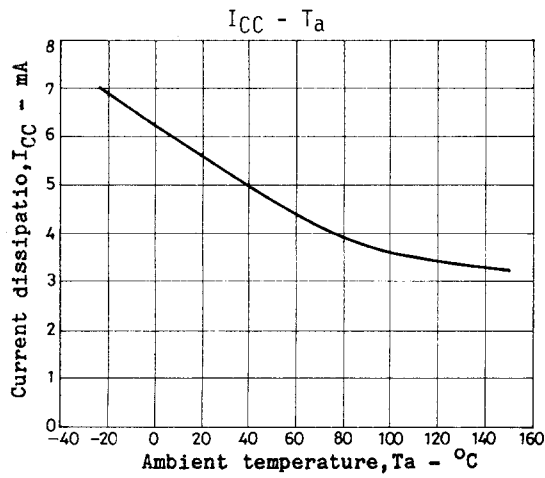
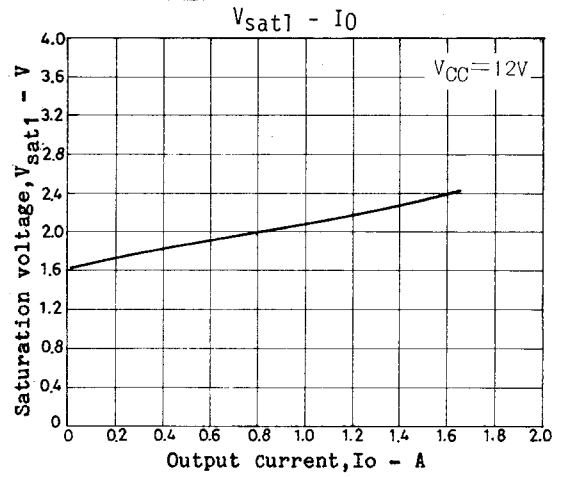
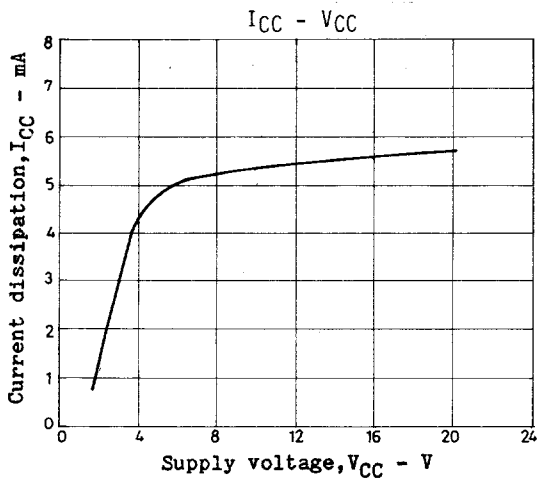
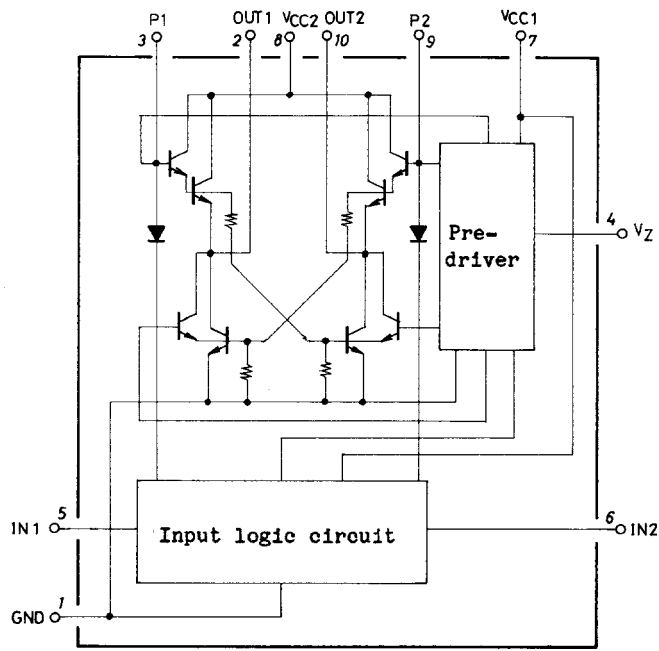

LB1645N

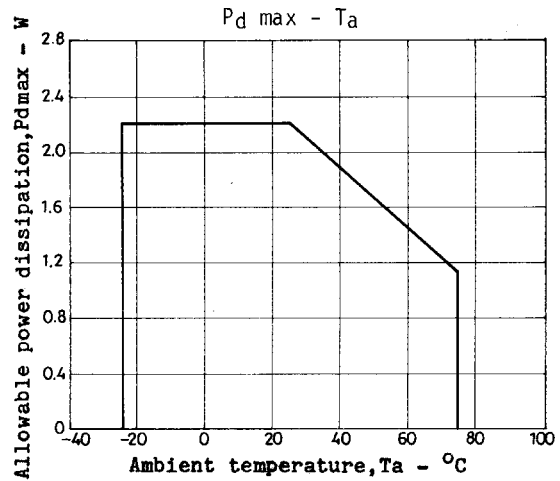
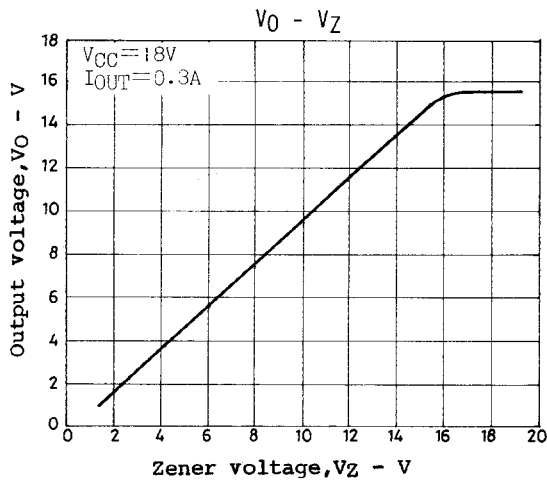

- Specifications of any and all SANYO products described or contained herein stipulate the performance, characteristics, and functions of the described products in the independent state, and are not guarantees of the performance, characteristics, and functions of the described products as mounted in the customer's products or equipment. To verify symptoms and states that cannot be evaluated in an independent device, the customer should always evaluate and test devices mounted in the customer's products or equipment.
- SANYO Electric Co., Ltd. strives to supply high-quality high-reliability products. However, any and all semiconductor products fail with some probability. It is possible that these probabilistic failures could give rise to accidents or events that could endanger human lives, that could give rise to smoke or fire, or that could cause damage to other property. When designing equipment, adopt safety measures so that these kinds of accidents or events cannot occur. Such measures include but are not limited to protective circuits and error prevention circuits for safe design, redundant design, and structural design.
- In the event that any and all SANYO products described or contained herein fall under strategic products (including services) controlled under the Foreign Exchange and Foreign Trade Control Law of Japan, such products must not be exported without obtaining export license from the Ministry of International Trade and Industry in accordance with the above law.
- No part of this publication may be reproduced or transmitted in any form or by any means, electronic or mechanical, including photocopying and recording, or any information storage or retrieval system, or otherwise, without the prior written permission of SANYO Electric Co., Ltd.
- Any and all information described or contained herein are subject to change without notice due to product/technology improvement, etc. When designing equipment, refer to the "Delivery Specification" for the SANYO product that you intend to use.
- Information (including circuit diagrams and circuit parameters) herein is for example only; it is not guaranteed for volume production. SANYO believes information herein is accurate and reliable, but no guarantees are made or implied regarding its use or any infringements of intellectual property rights or other rights of third parties.

This catalog provides information as of August, 1998. Specifications and information herein are subject to change without notice.