



SANYO Semiconductors

DATA SHEET

LA76810A — Monolithic Linear IC For PAL/NTSC Color Television Sets VIF/SIF/Y/Deflection 1chip IC

Overview

LA76810A is a VIF/SIF/Y/Deflection 1chip IC for PAL/NTSC color television sets.

Functions

- VIF/SIF/Y/Deflection Implemented in a 1chip.
- I²C Bus Control

Specifications

Maximum Ratings at Ta = 25°C

Parameter	Symbol	Conditions	Ratings	Unit
Maximum supply voltage	V ₈ max		7.0	V
	V ₃₁ max		7.0	V
	V ₄₃ max		7.0	V
Maximum supply current	I ₁₈ max		25	mA
	I ₂₅ max		35	mA
Allowable power dissipation	P _d max	T _a ≤ 65°C *	1.6	W
Operating temperature	T _{opg}	www.DataSheet4U.com	-10 to +65	°C
Storage temperature	T _{stg}		-55 to +150	°C

* Provided with a glass epoxy board (114.3×76.1×1.6 mm³)

Operating Conditions at Ta = 25°C

Parameter	Symbol	Conditions	Ratings	Unit
Recommended supply voltage	V ₈		5.0	V
	V ₃₁		5.0	V
	V ₄₃		5.0	V
Recommended supply current	I ₁₈		19	mA
	I ₂₅		27	mA
Operating supply voltage range	V ₈ op		4.7 to 5.3	V
	V ₃₁ op		4.7 to 5.3	V
	V ₄₃ op		4.7 to 5.3	V
Operating supply current range	I ₂₅ op		24 to 30	mA
	I ₁₈ op		17 to 21	mA

■ Any and all SANYO Semiconductor products described or contained herein do not have specifications that can handle applications that require extremely high levels of reliability, such as life-support systems, aircraft's control systems, or other applications whose failure can be reasonably expected to result in serious physical and/or material damage. Consult with your SANYO Semiconductor representative nearest you before using any SANYO Semiconductor products described or contained herein in such applications.

■ SANYO Semiconductor assumes no responsibility for equipment failures that result from using products at values that exceed, even momentarily, rated values (such as maximum ratings, operating condition ranges, or other parameters) listed in products specifications of any and all SANYO Semiconductor products described or contained herein.

SANYO Semiconductor Co., Ltd.

TOKYO OFFICE Tokyo Bldg., 1-10, 1 Chome, Ueno, Taito-ku, TOKYO, 110-8534 JAPAN

LA76810A

Electrical Characteristics Ta = 25°C, V_{CC}L = V₈ = V₃₁ = V₄₃ = 5.0V, I_{CC} = I₁₈ = 19mA, I_{CC} = I₂₅ = 27mA

Parameter	Symbol	Conditions	Ratings			Unit
			min	typ	max	
[Circuit voltage, current]						
IF supply current	I ₈	V ₈ = 5V, V ₃ = 2.5V		65.0		mA
RGB supply voltage	V ₁₈	I ₁₈ = 19mA		8.0		V
Horizontal supply voltage	V ₂₅	I ₂₅ = 27mA		5.0		V
CCD supply current	I ₃₁	I ₃₁ = 5V		5.6		mA
Video supply current	I ₄₃	I ₄₃ = 5V		124.0		mA
[CCD block]						
Voltage gain R	GV _R		-2	0	2	dB
Voltage gain B	GV _B		-2	0	2	dB
Difference of voltage gain	DGV		0	0.1	0.3	dB
Delay time	T _d			63.8		μs
[OSD block]						
OSD Fast SW threshold	FSTH		1.7	1.9	2.2	V
Red RGB output level	ROSDH		120	165	200	IRE
Green RGB output level	GOSDH		70	120	140	IRE
Blue RGB output level	BOSDH		85	120	155	IRE
Analog OSD R output level Gain match	RRGB		1.12	1.4	1.68	Ratio
Linearity	LRRGB		45	50	60	%
Analog OSD G output level Gain match	GRGB		0.8	1	1.2	Ratio
Linearity	LGRGB		45	50	60	%
Analog OSD B output level Gain Match	BRGB		0.8	1.0	1.2	Ratio
Linearity	LBRGB		45	50	60	%
[RGB output (cutoff drive) block] www.DataSheet4U.com						
Brightness control (Normal)	BRT64		1.7	2	2.4	V
Hi brightness (max)	BRT127		15	20	25	IRE
Low brightness (min)	BRT0		-25	-20	-15	IRE
Cutoff control (min)	V _{bias0}		1.6	2	2.4	V
(Bias control) (max)	V _{bias255}		2.6	3	3.4	V
Resolution	V _{biassns}			4		mV/Bit
Sub-bias control Resolution	V _{sbiassns}			7		mV/Bit
Drive adjustment Maximum output output	R _{bout63}			2.5		V _{p-p}
Output attenuation	R _{Bout0}		7	9	11	dB
[VIF block]						
Maximum RFAGC voltage	VRFH	CW = 80dBμ, DAC = 0	8.5	9		V _{dc}
Minimum RFAGC voltage	VRFL	CW = 80dBμ, DAC = 63	0	0.3	0.7	V _{dc}
RF AGC Delay Pt (@DAC = 0)	RFAGC0	DAC = 0	85			dBμ
RF AGC Delay Pt (@DAC = 63)	RFAGC63	DAC = 63			75	dBμ
Input sensitivity	V _i	Output-3db			46	dBμ
No-signal video output voltage	V _{On}	No signal	3.1	3.5	3.9	V _{dc}
Sync signal tip level	V _{Otip}	CW = 80dBμ	0.9	1.2	1.5	V _{dc}
Video output amplitude	V _O	80dBμ, AM = 78%, fm = 15kHz	1.9	2.0	2.1	V _{p-p}
Video S/N	S/N	CW = 80dBμ		45		dB
C-S beat level	IC-S	V4.43MHz/V1.07MHz		30		dB
Differential gain	DG	80dBμ, 87.5% Video MOD		5.0	10.0	%
Differential phase	DP	80dBμ, 87.5% Video MOD		2.0	10.0	deg
Maximum AFT output voltage	VAFTH	CW = 80dBμ, frequency variations	4.3	4.7	5	V _{dc}

Continued on next page.

LA76810A

Continued from preceding page.

Parameter	Symbol	Conditions	Ratings			Unit
			min	typ	max	
Minimum AFT output voltage	VAFTL	CW = 80dB μ , frequency variations	0.0	0.2	0.7	Vdc
AFT detection sensitivity	VAFTS	CW = 80dB μ , frequency variations	12.0	20.0	28.0	mV/kHz
APC pull-in range (U)	fPU		1.0			MHz
APC pull-in range (L)	fPL		1.0			MHz
NT Trap1 (4.5MHz)	NTR1	for 1MHz		-35		dB
NT Trap2 (4.8MHz)	NTR2	for 1MHz		-20		dB
BG Trap1 (5.5MHz)	BTR1	for 1MHz		-35		dB
BG Trap2 (5.85MHz)	BTR2	for 1MHz		-20		dB
I Trap1 (6.0MHz)	ITR1	for 1MHz		-35		dB
I Trap2 (6.55MHz)	ITR2	for 1MHz		-20		dB
DK Trap1 (6.5MHz)	DTR1	for 1MHz		-35		dB
NT Group Delay1 (3.5MHz)	NGD1	for 1MHz		200		ns
NT Group Delay2 (4.0MHz)	NGD2	for 1MHz		700		ns
BG Group Delay1 (4.0MHz)	BGD1	for 1MHz		100		ns
BG Group Delay2 (4.4MHz)	BGD2	for 1MHz		200		ns
I Group Delay1 (4.0MHz)	IGD1	for 1MHz		50		ns
I Group Delay2 (4.4MHz)	IGD2	for 1MHz		90		ns
DK Group Delay1 (4.0MHz)	DGD1	for 1MHz		30		ns
DK Group Delay2 (4.4MHz)	DGD2	for 1MHz		40		ns
[SIF block]						
FM detection output voltage	SOADJ		580	600	620	mVrms
FM limiting sensitivity	SLS	Output -3dB			61	dB μ
FM detection output f characteristics	SF	fm = 100kHz	-0.5	6.0	9.0	dB
FM detection output distortion	STHD	FM = \pm 30kHz			1.0	%
AM rejection ratio	SAMR	AM = 30% <small>www.DataSheet4U.com</small>	40			dB
SIF S/N	SSN	DIN.Audio	50			dB
PAL de-emph time constant	SPTC			3.0		dB
PAL/NT difference of voltage gain	SGD			0.0		dB
TN de-emph time constant	SNTC			3.0		dB
BPF 3dB band width	SBW			3.0		dB
[AUDIO block]						
Maximum gain	AGMAX	1kHz	-2.5	0.0	2.5	dB
Variable range	ARANGE		60	65		dB
Frequency characteristics	AF	20kHz	-3.0		3.0	dB
Mute	AMUTE	20kHz	70		-	dB
Distortion	ATHD	1kHz, 500mVrms, Vol: MAX			0.5	%
S/N	ASN	DIN.Audio	65	70		dB
Crosstalk	ACT	20kHz	70			dB
[Video SW block]						
Video signal input 1DC voltage	V _{IN} 1DC		2.2	2.5	2.8	V
Video signal input 1AC voltage	V _{IN} 1AC			1		Vp-p
Video signal input 2DC voltage	V _{IN} 2DC		2.2	2.5	2.8	V
Video signal input 2AC voltage	V _{IN} 2AC			1		Vp-p
SVO terminal DC voltage	SVODC		1.7	2	2.3	V
SVO terminal AC voltage	SVOAC		1.7	2	2.3	Vp-p
[Filter block]						
Chroma trap amount NTSC	CtrapN		-36.0	-26.0	-22.0	dB
Chroma trap amount PAL	CtrapP		-36.0	-26.0	-22.0	dB
C-BPF1A (3.93MHz)	CBPF1A	Reference: 4.43MHz FILTER SYS = 0010	-6.0	-3.0	0.0	dB

Continued on next page.

LA76810A

Continued from preceding page.

Parameter	Symbol	Conditions	Ratings			Unit
			min	typ	max	
C-BPF1B (4.73/4.13MHz)	CBPF1B	Reference: 4.13MHz FILTER SYS = 0010	-0.5	1.5	3.5	dB
C-BPF1C (4.93/3.93MHz)	CBPF1C	Reference: 3.93MHz FILTER SYS = 0010	6.0	4.0	1	dB
C-BPF2A (3.93MHz)	CBPF2A	Reference: 4.43MHz FILTER SYS = 0011	-4.0	-1.0	0.0	dB
C-BPF2B (4.73/4.13MHz)	CBPF2B	Reference: 4.13MHz FILTER SYS = 0011	-2.0	0.0	2.0	dB
C-BPF2C (4.93/3.93MHz)	CBPF2C	Reference: 3.93MHz FILTER SYS = 0011	-2.5	0.0	2.5	dB
Y-DL TIME1 S-VHS	TdY1	FILTER SYS = 0100	300.0	350.0	400.0	ns
Y-DL TIME2 PAL	TdY2	FILTER SYS = 0010	490.0	540.0	590.0	ns
Y-DL TIME3 NTSC	TdY3	FILTER SYS = 0001	530.0	580.0	630.0	ns
Y-DL TIME4 SECAM	TdY4	FILTER SYS = 1000	630.0	680.0	730.0	ns
[Video block]						
Video overall gain (Contrast max)	CONT127		9.0	11.0	13.0	dB
Contrast adjustment Characteristics (Normal/max)	CONT63		-7.5	-6.0	-4.5	dB
Contrast adjustment Characteristics (Min/max)	CONT0		-15.0	-12.0	-9.0	dB
Sharpness (Normal) variability (max) range (min)	Sharp31	FILTER SYS = 0000	6.0	9.0	12.0	dB
	Sharp63	FILTER SYS = 0000	9.0	12.0	15.0	dB
	Sharp0	FILTER SYS = 0000	-4.0	-1.0	2.0	dB
Maximum black stretch gain	BKSTmax		20.0	25.0	30.0	IRE
Black stretch threshold (60IRE Δblack)	BKSTTH		-5.0	0.0	5.0	IRE
DC transmission amount	ClampG		95.0	100.0	105.0	%
Horizontal/vertical blanking output level	RGBBLK		0.1	0.4	0.7	V
Video frequency characteristics 1 S-VHS	BW1	6.0MHz/100kHz	-6.0	-3.0	0.0	dB
Video frequency characteristics 2 PAL	BW2	3.2MHz/100kHz	-6.0	-3.0	0.0	dB
Video frequency characteristics 3 NTSC	BW3	2.6MHz/100kHz	-6.0	-3.0	0.0	dB
Video frequency characteristics 4 SECAM	BW4	3.1MHz/100kHz	-6.0	-3.0	0.0	dB
[Chroma block]: PAL/NTSC common						
B-Y/Y amplitude ratio	CLRBY		75	100	150	%
Color control characteristics 1	CLRMN	Color MAX/CEN	1.6	2.0	2.4	deg
Color control characteristics 2	CLRMM	Color MAX/MIN	33	40	50	dB
Color control sensitivity	CLRSE		1	2	4	%/bit
fsc output label	FSC37			200		mVp-p
Residual higher harmonic level B	E_CAR_B				300	mVp-p
Residual higher harmonic level R	E_CAR_R				300	mVp-p
Residual higher harmonic level G	E_CAR_G				300	mVp-p

Continued on next page.

LA76810A

Continued from preceding page.

Parameter	Symbol	Conditions	Ratings			Unit
			min	typ	max	
[Chroma block]: PAL						
ACC amplitude characteristics 1	ACCM1_P	Input: +6dB/0dB 0dB = 40IRE	0.8	1.0	1.2	deg
ACC amplitude characteristics 2	ACCM2_P	Input: -20dB/0dB	0.7	1.0	1.1	deg
Demodulation output ratio R-Y/B-Y: PAL	RB_P	R-Y/B-Y_GainBalance_DAC, R-Y/B-Y_Angle_DAC = Center	0.50	0.56	0.67	deg
Demodulation output ratio G-Y/B-Y: PAL	GB_P	R-Y/B-Y_GainBalance_DAC, R-Y/B-Y_Angle_DAC = Center, R-Y= no-signal	-0.21	-0.19	-0.17	deg
Demodulation output ratio G-Y/R-Y: PAL	GR_P	R-Y/B-Y_GainBalance_DAC, R-Y/B-Y_Angle_DAC = Center, B-Y = no-signal	-0.56	-0.51	-0.46	deg
Demodulation angle R-Y/B-Y: PAL	ANGBR_P	R-Y/B-Y_GainBalance_DAC, R-Y/B-Y_Angle_DAC = Center	85	90	95	deg
Killer operating point	KILL_P	0dB = 40IRE	-36	-30	-23	dB
APC pull-in range (+)	PULIN+_P		350			Hz
APC pull-in range (-)	PULIN-_P				-350	Hz
[Chroma block]: NTSC						
ACC amplitude characteristics 1	ACCM1_N	Input: +6dB/0dB 0dB = 40IRE	0.8	1.0	1.2	deg
ACC amplitude characteristics 2	ACCM2_N	Input: -20dB/0dB	0.7	1.0	1.1	deg
Demodulation output ratio R-Y/B-Y: NTSC	RB_N	R-Y/B-Y_GainBalance_DAC, R-Y/B-Y_Angle_DAC = Center	0.80	0.90	1.00	deg
Demodulation output ratio G-Y/B-Y: NTSC	GB_N	R-Y/B-Y_GainBalance_DAC, R-Y/B-Y_Angle_DAC = Center	0.24	0.30	0.38	deg
Demodulation angle B-Y/R-Y: NTSC	ANGBR_N	R-Y/B-Y_GainBalance_DAC, R-Y/B-Y_Angle_DAC = Center	99	104	109	deg
Demodulation angle G-Y/B-Y: NTSC	ANGGB_N	R-Y/B-Y_GainBalance_DAC, R-Y/B-Y_Angle_DAC = Center	227	240	250	deg
Killer operating point	KILL_N	0dB = 40IRE	-39	-32	-25	dB
APC pull-in range (+)	PULIN+_N		350			Hz
APC pull-in range (-)	PULIN-_N				-350	Hz
Tint center	TINCEN		-10	0	10	deg
Tint variable range (+)	TINT+		35			deg
Tint variable range (-)	TINT-				-35	deg
[Deflection block]						
Horizontal free-running frequency	fH		15500	15625	15750	Hz
Horizontal pull-in range	fH PULL		±400			Hz
Horizontal output pulse width	Hduty		36.1	37.6	39.1	µs
Horizontal output pulse saturation voltage	V Hsat		0	0.2	0.4	V
Vertical free-running cycle 50	VFR50		312.0	312.5	313.0	H
Vertical free-running cycle 60	VFR60		262.0	262.5	263.0	H
Horizontal output pulse phase	HPHCENpal		9.5	10.5	11.5	µs
Horizontal output pulse phase	HPHCENnt		9.5	10.5	11.5	µs
Horizontal position adjustment range	HPHrange	5bit		±2.2		µs
Horizontal position adjustment maximum variability width	HPHstep				200.0	ns
POR circuit operating voltage	VPOR		3.70	4.00	4.30	V
Horizontal blanking left @0	BLKL0	BLKL: 000	7500	8300	9100	ns
Horizontal blanking left @7	BLKL7	BLKL: 111	10800	11600	12400	ns
Horizontal blanking right @0	BLKR0	BLKR: 000	1800	2600	3400	ns
Horizontal blanking right @7	BLKR7	BLKR: 111	-1100	-300	500	ns
Sand castle pulse crest value H	SANDH		5.3	5.6	5.9	V
Sand castle pulse crest value M1	SANDM1		3.7	4.0	4.3	V
Sand castle pulse crest value L	SANDL		0.1	0.4	0.7	V

Continued on next page.

LA76810A

Continued from preceding page.

Parameter	Symbol	Conditions	Ratings			Unit
			min	typ	max	
Sand castle pulse crest value M2	SANDM2		1.7	2.0	2.3	V
Burst gate pulse width	BGPWD		3.5	4.0	4.5	μs
Burst gate pulse phase	BGPPH		4.9	5.4	5.9	μs
SECAM V pulse width	SECAMV		11.0	11.5	12.0	H
<Vertical screen size adjustment>						
Vertical ramp output amplitude PAL@64	Vspal64	VSIZE: 1000000	0.75	0.85	0.95	Vp-p
Vertical ramp output amplitude NTSC@64	Vsnt64	VSIZE: 1000000	0.75	0.85	0.95	Vp-p
Vertical ramp output amplitude PAL@0	Vspal0	VSIZE: 0000000	0.40	0.50	0.60	Vp-p
Vertical ramp output amplitude PAL@127	Vspal127	VSIZE: 1111111	1.05	1.20	1.35	Vp-p
<High-voltage dependent vertical size correction>						
Vertical size correction @0	Vsizecomp	VCOMP: 000	0.83	0.88	0.93	ratio
<Vertical screen position adjustment>						
Vertical ramp DC voltage PAL@32	Vdcpal32	VDC: 100000	2.25	2.40	2.55	Vdc
Vertical ramp DC voltage NTSC@32	Vdnt32	VDC: 100000	2.25	2.40	2.55	Vdc
Vertical ramp DC voltage PAL@0	Vdcpal0	VDC: 000000	1.85	2.00	2.15	Vdc
Vertical ramp DC voltage PAL@63	Vdcpal63	VDC: 111111	2.65	2.80	2.95	Vdc
Vertical linearity @16	Vlin16	VLIN: 10000	0.85	1.00	1.15	ratio
Vertical linearity @0	Vlin0	VLIN: 00000	1.17	1.32	1.47	ratio
Vertical linearity @31	Vlin31	VLIN: 11111	0.57	0.72	0.87	ratio
Vertical S-shaped correction @16	VScor16	VSC: 10000	0.55	0.70	0.85	ratio
Vertical S-shaped correction @0	VScor0	VSC: 00000	0.85	1.00	1.15	ratio
Vertical S-shaped correction @31	VScor31	VSC: 11111	0.36	0.51	0.66	ratio

Package Dimensions

unit : mm

3273

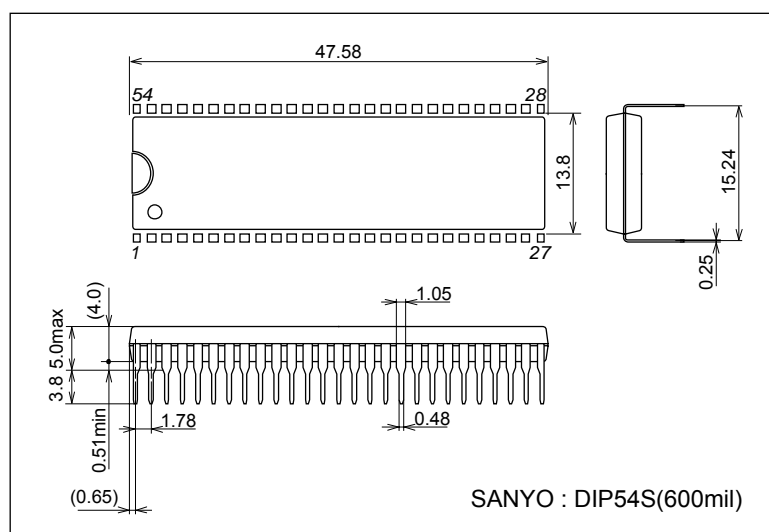

LA76810A



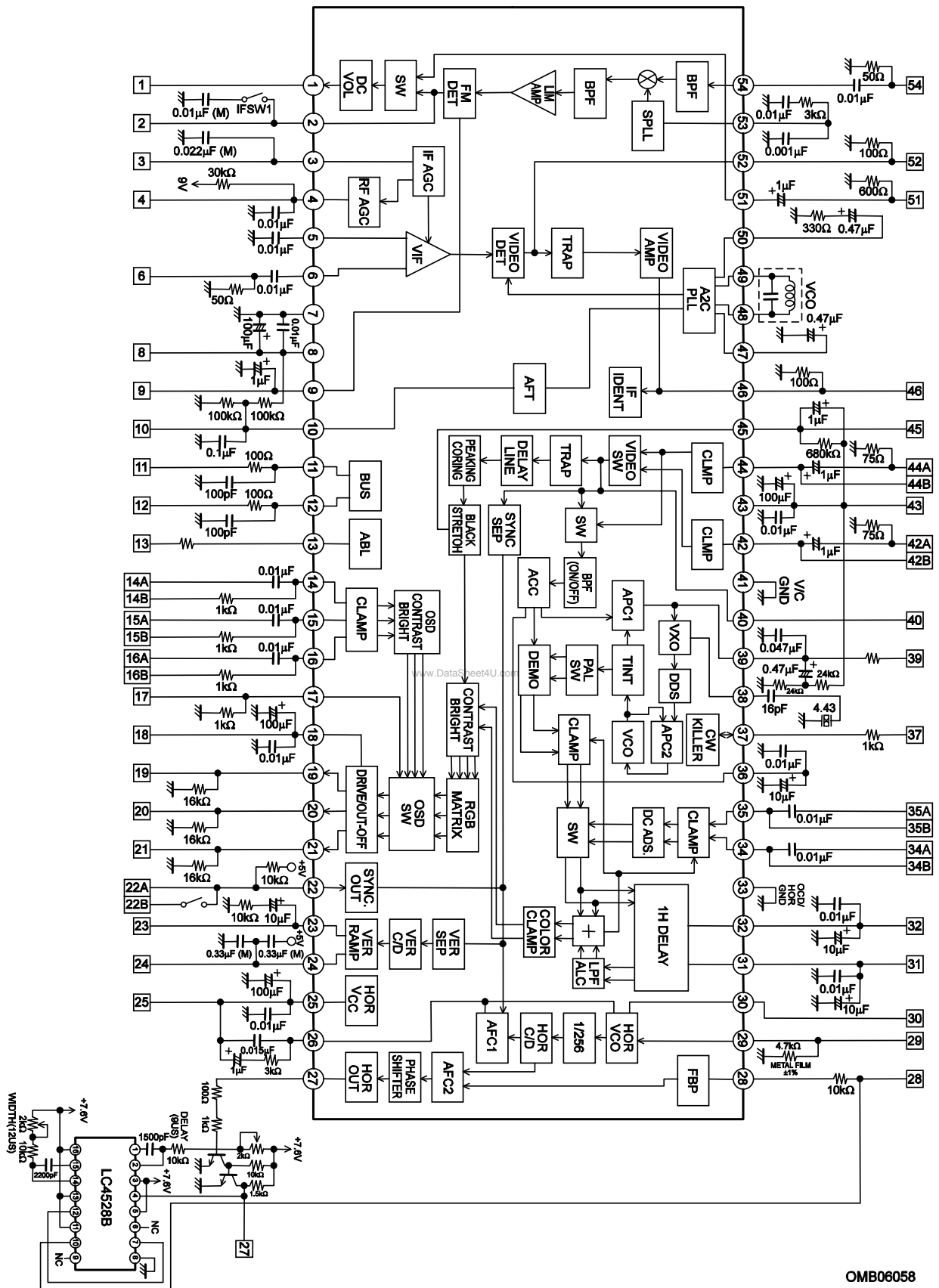

Block Diagram and Test Circuit



OMB06058





LA76810A

Test Conditions $T_a = 25^\circ\text{C}$, $V_{CC} = V_8 = V_{31} = V_{43} = 5.0\text{V}$, $I_{18} = 19\text{mA}$, $I_{CC} = I_{25} = 27\text{mA}$

Parameter	Symbol	Test point	Input signal	Test method	Bus conditions
[Circuit voltage, current]					
Horizontal supply voltage (pin 25)	V_{25}		No signal	Apply a current of 27mA to pin 25 and measure the voltage at pin 25.	Initial
RGB supply voltage (pin 18)	V_{18}		No signal	Apply a current of 19mA to pin 18 and measure the voltage at pin 18.	Initial
IF supply current (pin 8)	I_8 ($CDDI_{CC}$)		No signal	Apply a voltage of 5.0V to pin 8 and measure the incoming DC current (mA). (IF AGC 2.5V applied)	Initial
CCD supply current (pin 31)	I_{31} ($CCDI_{CC}$)		No signal	Apply a voltage of 5.0V to pin 31 and measure the incoming DC current (mA).	Initial
Video/vertical supply current (pin 43)	I_{43} ($DEFI_{CC}$)		No signal	Apply a voltage of 5.0V to pin 43 and measure the incoming DC current (mA).	Initial

VIF Block Input Signals and Test Conditions

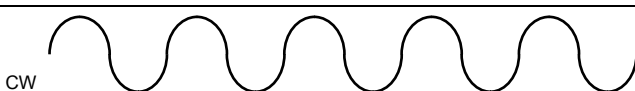
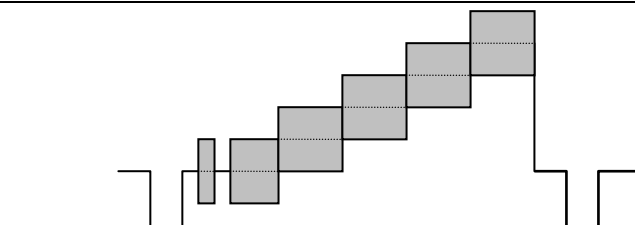
- Input signals must all be input to the PIF IN (pin 6) in the Test Circuit.
- All input signal voltage values are the levels at the VIF IN (pin 6) in the Test Circuit.
- Signal contents and signal levels

Input signal	Waveform	Conditions
SG1	 <small>www.DataSheet4U.com</small>	38.9MHz
SG2		34.47MHz
SG3		33.4MHz
SG4		Frequency variable
SG5		38.9MHz 87.5% Video Mod. 10-stairstep wave (Subcarrier: 4.43MHz)
SG6		38.9MHz $f_m = 15\text{kHz}$, AM = 78%

- Before measurement, adjust the DAC as follows.

Parameter	Test point	Input signal	Adjustment
Video Level DAC		SG6, 80dB μ	Set the output level at pin 46 as close to 2.0Vp-p as possible.

LA76810A

VIF Block Test Conditions

Input signal	Symbol	Test point	Input signal	Test method	Bus conditions
[VIF block]					
Maximum RF AGC voltage	VRFH	4	SG1 80dB μ	Measure the DC voltage at pin 4.	RF.AGC = "000000"
Minimum RF AGC voltage	VRFL	4	SG1 80dB μ	Measure the DC voltage at pin 4.	RF.AGC = "111111"
RF AGC Delay Pt (@DAC = 0)	RFAGC0	4	SG1	Obtain the input level at which the DC voltage at pin 4 becomes 4.5V.	RF.AGC = "000000"
RF AGC Delay Pt (@DAC = 63)	RFAGC63	4	SG1	Obtain the input level at which the DC voltage at pin 4 becomes 4.5V.	RF.AGC = "111111"
Input sensitivity	Vi	46	SG6	Using an oscilloscope, observe the level at pin 46 and obtain the input level at which the waveform's p-p value becomes 1.4Vp-p.	
No-signal video output voltage	VOn	46	No signal	Set IF AGC = "1" and measure the DC voltage at pin 46.	
Sync signal tip level	VOtip	46	SG1 80dB μ	Measure the DC voltage at pin 46.	
Video output amplitude	VO	46	SG6 80dB μ	Using an oscilloscope, observe the level at pin 46 and measure the waveform's p-p value.	
Video S/N	S/N	46	SG1 80dB μ	Measure the noise voltage (Vsn) at pin 46 with an RMS voltmeter through a 10kHz to 5.0MHz band-pass filter and calculate $20 \log (1.43/V_{sn})$.	
C-S beat level	IC-S	46	SG1 SG2 SG3	Input a 80dB μ SG1 signal and measure the DC voltage (V3) at pin 3. Mix SG1 = 74dB μ , SG2 = 64 dB μ , and SG3 = 64 dB μ to enter the mixture in the VIF IN. Apply V3 to pin 3 from an external DC power supply. Using a spectrum analyzer, measure the difference between pin 46's 4.43MHz component and 1.07MHz component.	
Differential gain	DG	46	SG5 80dB μ	Using a vector scope, measure the level at Pin 46.	
Differential phase	DP	46	SG5 80dB μ	Using a vector scope, measure the level at Pin 46.	
Maximum AFT output voltage	VAFTH	10	SG4 80dB μ	Set and input the SG4 frequency to 37.9MHz to be input. Measure the DC voltage at pin 10 at that moment.	
Minimum AFT output voltage	VAFTL	10	SG4 80dB μ	Set and input the SG4 frequency to 39.9MHz to be input. Measure the DC voltage at pin 10 at that moment.	
AFT detection sensitivity	VAFTS	10	SG4 80dB μ	Adjust the SG4 frequency and measure frequency deviation Δf when the DC voltage at pin 10 changes from 1.5V to 3.5V. VAFTS = $2000/\Delta f$ [mV/kHz]	
APC pull-in range (U), (L)	fPU, fPL	46	SG4 80dB μ	Connect an oscilloscope to pin 46 and adjust the SG4 frequency to a frequency higher than 38.9MHz to bring the PLL into unlocked mode. (A beat signal appears.) Lower the SG4 frequency and measure the frequency at which the PLL locks again. In the same manner, adjust the SG4 frequency to a lower frequency to bring the PLL into unlocked mode. Higher the SG4 frequency and measure the frequency at which the PLL locks again.	

LA76810A

SIF Block (FM block) Input Signals and Test Conditions

Unless otherwise specified, the following conditions apply when each measurement is made.

1. Bus control condition: IF.AGC.SW = "1", SIF.SYS = "01", DEEM-TC = "0", FM.GAIN = "0"
2. SW:IF1 = "ON"
3. Input signals are input to pin 54 and the carrier frequency is 5.5MHz.

Input signal	Symbol	Test point	Input signal	Test method	Bus conditions
FM detection output voltage	SOADJ	2	90dB μ , fm = 400Hz, FM = \pm 30kHz	Adjust the DAC (FM.LEVEL) such that the 400Hz component of the FM detection output at pin 2 become as close to 600mVrms as possible and measure (SV1:mVrms) the output at that moment.	
FM limiting sensitivity	SLS	2	fm = 400Hz, FM = \pm 30kHz	Measure the input level (dB μ) at which the 400Hz component of the FM detection output at pin 2 becomes -3dB relative to SV1.	FM level = Adjustment value
FM detection output f characteristics (fm = 100kHz)	SF	2	90dB μ , fm = 100kHz FM = \pm 30kHz	Set SW: IF1 = "OFF". Measure (SV2: mVrms) the FM detection output of pin 2. Calculate as follows: SF = 20*LOG (SV1/SV2) [dB]	FM level = Adjustment value
FM detection output distortion	STHD	2	90dB μ , fm = 400Hz, FM = \pm 30kHz	Measure the distortion factor of the 400Hz component of the FM detection output at pin 2.	FM level = Adjustment value
AM rejection ratio	SAMR	2	90dB μ , fm = 400Hz, AM = 30%	Measure the 1kHz component (SV3: mVrms) of the FM detection output at pin 2. Assign the measured value to SV3 and calculate as follows: SAMR = 20*LOG (SV1/SV3) [dB]	FM level = Adjustment value
SIF.S/N	SSN	2	90dB μ , CW	Measure the noise level (DIN AUDIO, SV4: mVrms) at pin 2. Calculate as follows: SSN=20*LOG(SV1/SV4) [dB]	FM level = Adjustment value
PAL de-emph time constant	SPTC	2	90dB μ , fm = 3.18KHz FM = \pm 30KHz	Measure the 3.18kHz component (SV5: mVrms) of the FM detection output at pin 2 and calculate as follows: SNTC = 20*LOG (SV1/SV5) [dB]	FM level = Adjustment value
PAL/NT Difference of voltage gain	SGD	2	fo = 4.5MHz 90dB μ , fm = 400Hz FM = \pm 15KHz	Measure the 400Hz component (SV6: mVrms) of the FM detection output at pin 2 and calculate as follows: SNTC = 20*LOG (SV1/SV6) [dB]	FM level = Adjustment value SIF.SYS = "00" DEEM-TC = "1" FM.GAIN = "1"
NT de-emph time constant	SNTC	2	fo = 4.5MHz 90dB μ , fm = 2.12kHz FM = \pm 15kHz	Measure the 2.12kHz component (SV7: mVrms) of the FM detection output at pin 2 and calculate as follows: SNTC = 20*LOG (SV6/SV7) [dB]	FM level = Adjustment value SIF.SYS = "00" DEEM-TC = "1" FM.GAIN = "1"
BPF 3db band width	SBW	2	90dB μ , CW	Set SW: IF1 = "OFF". Pin9 = 5V Measure the 458kHz component (SV8: mVrms) at pin 2. Set the input frequency to 5.565MHz to the input frequency and measure the 393kHz component (SV9: mVrms) at pin 2 to calculate as follows: SBW = 20*LOG (SV8/SV9) [dB]	FM level= Adjustment value

Audio Block Input Signals and Test Conditions

Unless otherwise specified, the following conditions apply when each measurement is made.

1. Bus control condition:

AUDIO.MUTE = "0", AUDIO.SW = "1", VOL.FIL = "0", SIF.SYS = "01", IF.AGC.SW = "1"

2. Input 5.5MHz, 90dBμ and CW at pin 54.

3. Enter an input signal from pin 51.

Input signal	Symbol	Test point	Input signal	Test method	Bus conditions
Maximum gain	AGMAX	1	1kHz, CW 500mVrms	Measure the 1kHz component (V1: mVrms) at the pin 1 and calculate as follows: AGMAX = 20*LOG (V1/500) [dB]	VOLUME = "1111111"
Variable range	ARANGE	1	1kHz, CW 500mVrms	Measure the 1kHz component (V2: mVrms) at the pin 1 and calculate as follows: ARANGE = 20*LOG (V1/V2) [dB]	VOLUME = "0000000"
Frequency characteristics	AF	1	20kHz, CW 500mVrms	Measure the 20kHz component (V3: mVrms) at the pin 1 and calculate as follows: AF = 20*LOG (V3/V1) [dB]	VOLUME = "1111111"
Mute	AMUTE	1	20kHz, CW 500mVrms	Measure the 20kHz component (V4: mVrms) at the pin 1 and calculate as follows: AMUTE = 20*LOG (V3/V4) [dB]	VOLUME = "1111111" AUDIO.MUTE = "1"
Distortion	ATHD	1	1kHz, CW 500mVrms	Measure the distortion of the 1kHz component at the pin 1.	VOLUME = "1111111"
S/N	ASN	1	No signal	Measure the noise level (DIN AUDIO, V5: mVrms) at the pin 1 and calculate as follows: ASN = 20*LOG (V1/V5) [dB]	VOLUME = "1111111"
Crosstalk	ACT	1	20kHz, CW 500mVrms	Measure the 20kHz component (V6: mVrms) at the pin 1 and calculate as follows: ACT = 20*LOG (V3/V6) [dB]	VOLUME = "1111111" AUDIO.SW = "0"

LA76810A

Video Block Input Signals and Test Conditions

C IN Input* chroma burst signal: 40 IRE

Y IN input signal 100IRE: 714mV

Bus control bit conditions: Initial test state

0IRE signal (L-0): NTSC standard sync signal

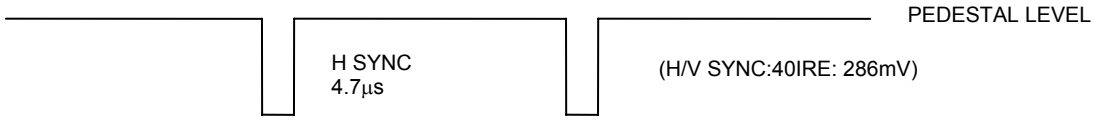

XIRE signal (L-X)



CW signal (L-CW)

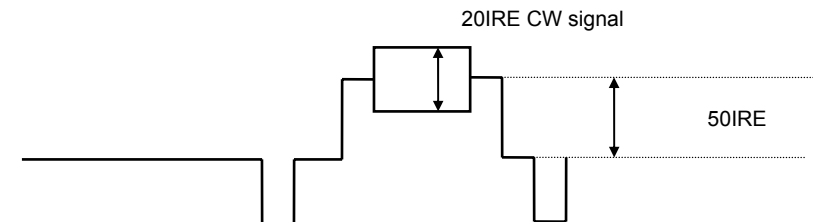

BLACK STRETCH 0IRE signal (L-BK)

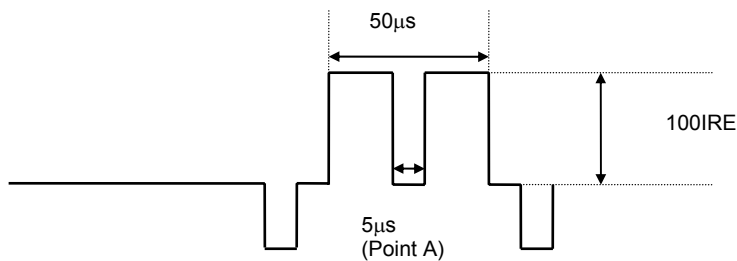

www.DataSheet4U.com

R/G/B IN Input signal

RGB Input signal 1 (0-1)

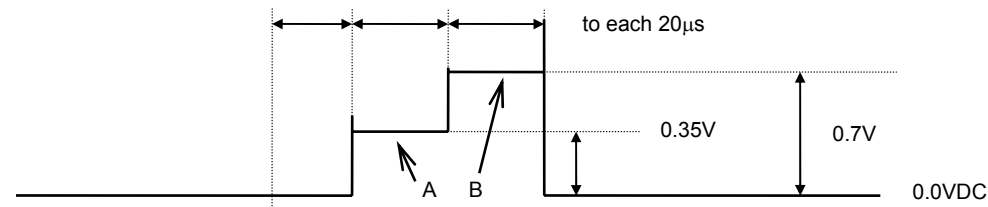

RGB Input signal 2 (0-2)

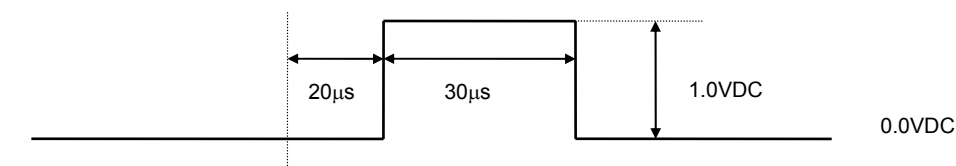

LA76810A

Video Block Test Conditions

Input signal	Symbol	Test point	Input signal	Test method	Bus bit/input signal
Video overall gain (Contrast max)	CONT127	21	L-50	Measure the output signal's 50IRE amplitude (CNTHB Vp-p) and calculate $CONT127 = 20\text{Log} (CNTHB/0.357)$.	CONTRAST: 1111111
Contrast adjustment characteristics (normal/max)	CONT63	21	L-50	Measure the output signal's 50IRE amplitude (CNTCB Vp-p) and calculate $CONT63 = 20\text{Log} (CNTCB/0.357)$.	CONTRAST: 0111111
Contrast adjustment characteristics (min/max)	CONT0	21	L-50	Measure the output signal's 50IRE amplitude (CNTLB Vp-p) and calculate $CONT0 = 20\text{Log} (CNTLB/0.357)$.	CONTRAST: 0000000
Video frequency Characteristics 1 (SVHS)	BW1	21	L-CW	With the input signal's continuous wave = 100kHz, measure the output signal's continuous wave amplitude (PEAKDC Vp-p). With the input signal's continuous wave = 6MHz, measure the output signal's continuous wave amplitude (CW7 Vp-p). Calculate BW1 = $20\text{Log} (CW6/PEAKDC)$.	FILTER SYS: 0100 SHARPNESS: 000000
Video frequency Characteristics 2 (PAL)	BW2	21	L-CW	With the input signal's continuous wave = 3.2MHz, measure the output signal's continuous wave amplitude (CW3.2 Vp-p). Calculate BW2 = $20\text{Log} (CW3.2/PEAKDC)$.	FILTER SYS: 0010 SHARPNESS: 000000
Video frequency Characteristics 3 (NTSC)	BW3	21	L-CW	With the input signal's continuous wave = 2.6MHz, measure the output signal's continuous wave amplitude (CW2.6 Vp-p). Calculate BW3 = $20\text{Log} (CW2.6/PEAKDC)$.	FILTER SYS: 0000 SHARPNESS: 000000
Video frequency Characteristics 4 (SECAM)	BW4	21	L-CW	With the input signal's continuous wave = 3.1MHz, measure the output signal's continuous wave amplitude (CW3.1 Vp-p). Calculate BW4 = $20\text{Log} (CW3.1/PEAKDC)$.	FILTER SYS: 1000 SHARPNESS: 000000
Chroma trap amount PAL	CtraPP	21	L-CW	With the input signal's continuous wave = 4.43MHz, measure the output signal's continuous wave amplitude (FOP Vp-p). Calculate CtraP = $20\text{Log} (FOP/PEAKDC)$.	FILTER SYS: 010 Sharpness: 000000
Chroma trap amount NTSC	CtraPN	21	L-CW	With the input signal's continuous wave = 3.58MHz, measure the output signal's continuous wave amplitude (FON Vp-p). Calculate CtraN = $20\text{Log} (FON/PEAKDC)$.	FILTER SYS: 000 Sharpness: 000000
DC transmission amount	ClampG1	21	L-0	Measure the output signal's 0IRE DC level (BRTPL V).	Brightness: 0000000 CONTRAST: 1111111
			L-100	Measure the output signal's 0IRE DC level (DRVPH V) and 100IRE amplitude (DRVH Vp-p) and calculate $ClampG = 100 \times (1 + (DRVPH - BRTPL)/DRVH)$.	Brightness: 0000000 Contrast: 1111111
Y-DL TIME1(SVHS)	TdY1	21	L-50	Obtain the time difference (the delay time) from when the rise of the input signal's 50IRE amplitude to the output signal's 50IRE amplitude.	FILTER SYS:0100
Y-DL TIME2(PAL)	TdY2	21	L-50	Obtain the time difference (the delay time) from when the rise of the input signal's 50IRE amplitude to the output signal's 50IRE amplitude.	FILTER SYS:0010
Y-DL TIME3(NTSC)	TdY3	21	L-50	Obtain the time difference (the delay time) from when the rise of the input signal's 50IRE amplitude to the output signal's 50IRE amplitude.	FILTER SYS:0000
Y-DL TIME4(SECAM)	TdY4	21	L-50	Obtain the time difference (the delay time) from when the rise of the input signal's 50IRE amplitude to the output signal's 50IRE amplitude.	FILTER SYS:1000

Continued on next page.

LA76810A

Continued from preceding page.

Input signal	Symbol	Test point	Input signal	Test method	Bus bit/input signal				
Maximum black stretch gain	BKSTmax	21	L-BK	Measure the 0IRE DC level (BKST1 V) at point A of the output signal in the Black Stretch Defeat (Black Stretch OFF) mode.	Blk Str DEF: 0				
				Measure the 0IRE DC level (BKST2 V) at point A of the output signal in the Black Stretch ON mode.					
				Calculate $BKSTmax = 2 \times 50 \times (BKST1 - BKST2) / CNTHB$.					
Black stretch threshold Δ_{black} (60IRE Δ_{black})	BKSTTH Δ	21	L-60	Measure the 60IRE DC level (BKST3 V) of the output signal in the Black Stretch Defeat ON mode.	Blk Str DEF: 0				
				Measure the 60IRE DC level (BKST4 V) of the output signal in the Black Stretch Defeat (Black Stretch OFF) mode.					
				Calculate $BKSTTH\Delta = 50 \times (BKST4 - BKST3) / CNTHB$.					
Sharpness variability characteristics (normal)	Sharp31	21	L-CW	With the input signal's continuous wave = 2.2MHz, measure the output signal's continuous wave amplitude (F00S31 Vp-p). Calculate Sharp31 = $20 \text{Log} (F00S31 / \text{PEAKDC})$.	FILTER SYS:0000 Sharpness: 100000				
				(max)		Sharp63	L-CW	With the input signal's continuous wave = 2.2MHz, measure the output signal's continuous wave amplitude (F00S63 Vp-p). Calculate Sharp63 = $20 \text{Log} (F00S63 / \text{PEAKDC})$.	FILTER SYS:0000 Sharpness: 111111
				(min)				Sharp0	
Horizontal/vertical blanking output level	RGBBLK	21	L-100	Measure the DC level (RGBBLK V) for the output signal's blanking period.					

[OSD block] Bus control bit conditions: Contrast = 63, Brightness = 63

Input signal	Symbol	Test point	Input signal	Test method	Bus bit/input signal
OSD Fast SW threshold	FSTH	21	L-0 O-2	Apply voltage to pin 17 and measure the voltage at pin 17 at the point where the output signal switches to the OSD signal.	Pin 16A: O-2 applied
Red RGB output level	ROSDC	19	L-50	Measure the output signal's 50IRE amplitude (CNTCR Vp-p).	Pin 17: 3.5V Pin 14A: O-2 applied
			L-0 O-2	Measure the OSD output amplitude (OSDHR Vp-p).	
			Calculate $ROSDC = 50 \times (ROSDC / \text{CNTCR})$		
Green RGB output level	GOSDC	20	L-50	Measure the output signal's 50IRE amplitude (CNTCG Vp-p).	Pin 17: 3.5V Pin 15A: O-2 applied
			L-0 O-2	Measure the OSD output amplitude (OSDHG Vp-p).	
			Calculate $GOSDC = 50 \times (GOSDC / \text{CNTCG})$		

Continued on next page.

LA76810A

Continued from preceding page.

Input signal	Symbol	Test point	Input signal	Test method	Bus bit/input signal
Blue RGB output level	BOSDC	21	L-50	Measure the output signal's 50IRE amplitude (CNTCB Vp-p).	
			L-0 O-2	Measure the OSD output amplitude (OSDHB Vp-p).	Pin 17: 3.5V Pin 16A: O-2 applied
				Calculate BOSDC = $50 \times (\text{OSDHB}/\text{CNTCB})$	
Analog OSD R output level		19	L-0 O-1	Measure the amplitudes at point A (0.35V portion of the input signal 0-1) and point B (0.7V portion of the input signal 0-1) of the output signal. Assign the measured values to RGBLR Vp-p and RGBHR Vp-p, respectively.	Pin 17 : 3.5V Pin 14A : O-1 applied
Gain match	RRGB			Calculate RRGB = RGBLR/CNTCR.	
linearity	LRRGB			Calculate LRRGB = $100 \times (\text{RGBLR}/\text{RGBHR})$.	
Analog OSD G output level		20	L-0 O-1	Measure the amplitudes at point A (0.35V portion of the input signal 0-1) and point B (0.7V portion of the input signal 0-1) of the output signal. Assign the measured values to RGBLG Vp-p and RGBHG Vp-p, respectively.	Pin 17: 3.5V Pin 15A: O-1 applied
Gain match	GRGB			Calculate GRGB = RGBLG/CNTCG.	
linearity	LGRGB			Calculate LGRGB = $100 \times (\text{RGBLG}/\text{RGBHG})$.	
Analog OSD B output level		21	L-0 O-1	Measure the amplitudes at point A (0.35V portion of the input signal 0-1) and point B (0.7V portion of the input signal 0-1) of the output signal. Assign the measured values to RGBLB Vp-p and RGBHB Vp-p, respectively.	Pin 17: 3.5V Pin 16A: O-1 applied
Gain match	BRGB			Calculate BRGB = RGBLB/CNTCB.	
linearity	LBRGB			Calculate LBRGB = $100 \times (\text{RGBLB}/\text{RGBHB})$.	

[RGB output block] (Cutoff, drive block) Bus control bit conditions: Contrast=127

Input signal	Symbol	Test point	Input signal	Test method	Bus bit/input signal
Brightness control (normal)	BRT63	19	L-0	Measure the 0IRE DC levels of the respective output signals of R output (19), G output (20), and B output (21). Assign the measured values to BRTPCR, BRTPCG, and BRTPCB V, respectively. Calculate BRT63 = $(\text{BRTPCR} + \text{BRTPCG} + \text{BRTPCB})/3$.	Brightness: 01111111
		20			
		21			
(max)	BRT127	21		Measure the 0IRE DC level of the output signal of B output (21) and assign the measured value to BRTPHB. Calculate BRT127 = $50 \times (\text{BRTPHB} - \text{BRTPCB})/\text{CNTHB}$.	Brightness: 1111111
(min)	BRT0			Measure the 0IRE DC level of the output signal of B output (21) and assign the measured value to BRTPLB. Calculate BRT0 = $50 \times (\text{BRTPLB} - \text{BRTPCB})/\text{CNTHB}$.	Brightness: 0000000

Continued on next page.

LA76810A

Continued from preceding page.

Input signal	Symbol	Test point	Input signal	Test method	Bus bit/input signal	
Bias (cutoff) control I_{min}	Vbias0	19	L-50	Measure the 0IRE DC levels (Vbias0* V) of the respective output signals of R output (19), G output (20), and B output (21). *: R, G, and B	Sub-Brightness: 0000000	
	(max)	Vbias255			20	Sub-Brightness: 1111111
					21	Red/Green/Blue Bias: 11111111
Bias (cutoff) control resolution	Vbiassns			Measure the 0IRE DC levels (BAS80* V) of the respective output signals of R output (19), G output (20), and B output (21). *: R, G, and B	Red/Green/Blue Bias:01010000	
				Measure the 0IRE DC levels (BAS48* V) of the respective output signals of R output (19), G output (20), and B output (21). *: R, G, and B	Red/Green/Blue Bias: 00110000	
				Calculate Vbiassns* = (BAS80*-BAS48*)/32		
Sub-bias control resolution	Vsbiassns		L-50	Measure the 0IRE DC levels (SBTPM* V) of the respective output signals of R output (19), G output (20), and B output (21). *: R, G, and B Calculate Vsbiassns* = (BRTPC*-SBTPM*)	Sub-Brightness: 0101010 Contrast: 0111111	
Drive adjustment maximum output	RBout127	19	L-100	Measure the 100IRE amplitudes (DRVH* Vp-p) of the respective output signals of R output (19) and B output (21). *: R and B Measure the 100IRE amplitude of the output signal of G output (20) and assign the measured value to DRVH* Vp-p. *: G	Brightness: 0000000	
	Gout15	20				
		21				
Output attenuation	RBout0			Measure the 100IRE amplitudes (DRVL* Vp-p) of the respective output signals of R output (19), G output (20), and B output (21). *: R and B Measure the 100IRE amplitude of the output signal of G output (20) and assign the measured value to DRVL* Vp-p. *: G	Brightness: 0000000 Red/Blue Drive: 0000000	
	Gout0			RBout0* = 20Log (DRVH*/DRVL*) Gout0* = 20Log (DRVH*/DRVL*)		
Gamma correction	R _γ G _γ B _γ	19	L-100	Measure the 100IRE amplitude of the respective output signals of R output (28), G output (29), and B output (30) with Gamma Def being ON and OFF. Assign the measured values to *A, *B and Vp-p, respectively. *: R, G, B * γ = 100*(A*B)	Contrast: 0111111 Brightness: 01111111 Gamma Def: Off,On B Gamma sel: 11,00	
		20				
		21				

LA76810A

[VIDEO SW block] Bus control bit conditions: Contrast = 63, Brightness = 63

Input signal	Symbol	Test point	Input signal	Test method	Bus bit/input signal
Video signal input 1DC voltage	VIN1DC	42	L-100	Input signals to pin 42 and measure the voltage of the pedestal.	VIDEO SW: 1
Video signal input 2DC voltage	VIN2DC	44	L-100	Input signals to pin 44 and measure the voltage of the pedestal.	VIDEO SW: 0
SVO terminal DC voltage	SVDC	40	L-100	Input signals to pin 42 and measure the voltage of the pedestal at pin 40.	VIDEO SW: 1
SVO terminal AC voltage	SVOAC	40	L-100	Input signals to pin 42 and measure the voltage of the pedestal at pin 40.	VIDEO SW: 1

Chroma Block Input Signals and Test Conditions

Unless otherwise specified, the following conditions apply when each measurement is made.

1. VIF, SIF blocks: No signal
2. Deflection Block: Horizontal/vertical composite sync signals are input and the deflection block must be locked into the sync signals (Refer to the Deflection Block Input Signals and the Test Conditions).
3. Bus control conditions: Set the following conditions unless otherwise specified.
 Y Input is 42 Pin (EXT-V IN),
 C Input is 44 Pin (S-C IN)
 (Video SW=1, C.Ext=1)

Other DAC except the above-mentioned conditions is all initial conditions.

4. Y Input condition: No signal unless otherwise specified.

(Sync is necessary to obtain synchronization).

5. How to calculate the demodulation ratio and angle:

www.DataSheet4U.com

$$B\text{-}Y \text{ axis angle} = \tan^{-1}(B(0)/B(270))+270^\circ$$

$$R\text{-}Y \text{ axis angle} = \tan^{-1}(R(180)/R(90))+90^\circ$$

$$G\text{-}Y \text{ axis angle} = \tan^{-1}(G(270)/G(180))+180^\circ$$

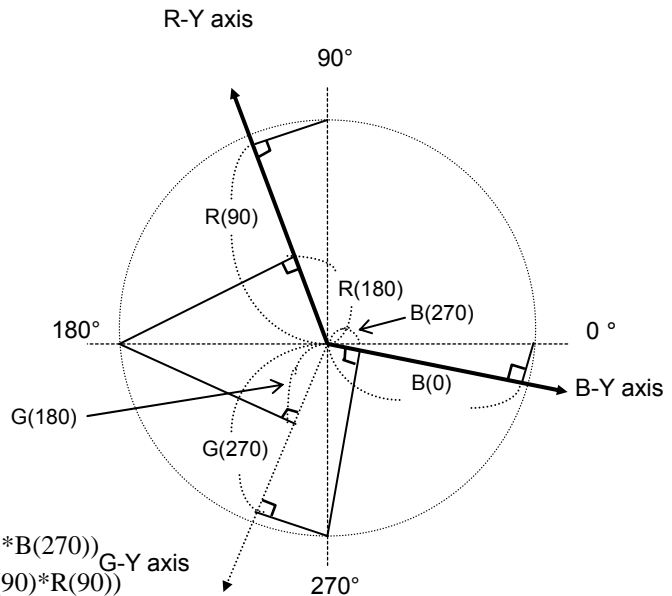

$$B\text{-}Y \text{ axis amplitude } V_b = \sqrt{B(0)*B(0)+B(270)*B(270)}$$

$$R\text{-}Y \text{ axis amplitude } V_r = \sqrt{R(180)*R(180)+R(90)*R(90)}$$

$$G\text{-}Y \text{ axis amplitude } V_g = \sqrt{G(180)*G(180)+G(270)*G(270)}$$

LA76810A

6. Chroma input signal:

As for the PAL signal, the burst swings such as 130° and 225° every one hour.

Chroma describes the phase caused when the burst occurs at 135° .

As for the NTSC signal, the burst occurs constantly at 180°.

The figures below are based on the phase of NTSC. When a PAL signal is generated, adjust the phase and then enter signals.

The item common to both PAL and NTSC is the PAL signal. For those other than this, the measurement must be performed for each individual signals.

The condition of fsc: Set the following conditions unless otherwise specified.

PAL = 4.433619MHz

NTSC = 3.579545MHz

C-1

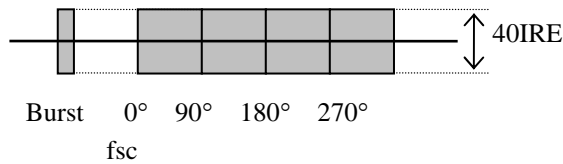

X IRE signal (L-X)

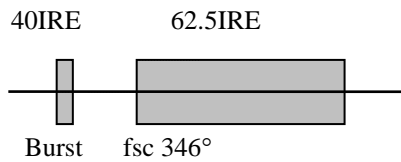

C-2

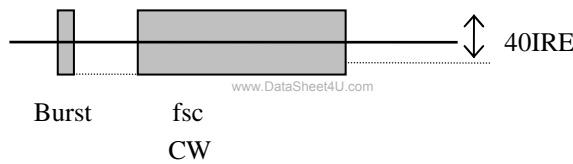

C-3

(Note: $fsc \pm N * fh$ when the frequency is specified.
N should be a natural number and the nearest value should be used.)

C-4

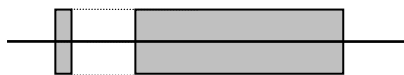

C-5

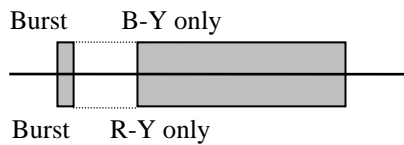

LA76810A

[Chroma block]: PAL/NTSC common

Input signal	Symbol	Test point	Input signal	Test method	Bus bit/input signal
B-Y/Y amplitude ratio	CLRBY	Bout 21	YIN:L77 No signal	Measure the Y system's output level. V1	
			C-2	Input a signal to the CIN (only sync signal to the YIN) and measure the output level to calculate as follows: $CLRBY = 100 \times (V2/V1)+15\%$	Color: 1000000
Color control characteristics 1	CLRMN	21	C-1	Measure the output amplitude V1 at color control MAX mode and output amplitude V2 at color control CEN mode and, calculate as follows: $CLRMN = V1/V2$	Color: 1111111 Color: 1000000
Color control Characteristics 2	CLRMM	21	C-1	Measure the output amplitude V3 at color control MIN mode to calculate as follows: $CLRMM = 20\log(V1/V3)$	Color: 0000000
Color control sensitivity	CLRSE	21	C-1	Measure the output amplitude V4 at color control 90 mode and output amplitude V5 at color control 38 mode to calculate as follows: $CLRSE = 100 \times (V4-V5)/(V2 \times 52)$	Color: 1011010 Color: 0100110
fsc output level	FSC37	37		Measure 4.43MHz output amplitude at pin 37.	
Residual higher harmonic level B	E_CAR_B	21	C-1 Burst only	Measure the 8.86MHz component output amplitude at pin 21.	
Residual higher harmonic level R	E_CAR_R	Rout 21	Burst only	Measure the 8.86MHz component output amplitude at pin 19.	
Residual higher harmonic level G	E_CAR_G	Gout 21	C-1 Burst only	Measure the 8.86MHz component output amplitude at pin 20.	

[Chroma block]: PAL

Input signal	Symbol	Test point	Input signal	Test method	Bus bit/input signal
ACC amplitude characteristics 1	ACCM1_P	Bout 21	C-1 0dB +6dB	Measure the output amplitude when 0dB is applied to the chroma input and the output amplitude when +6dB is applied to the chroma input and calculate the ratio between them. $ACCM1 = 20\log(+6dBdata/0dBdata)$	Color: 1000000
ACC amplitude characteristics 2	ACCM2_P	Bout 21	C-1 -20dB	Measure the output amplitude when -20dB is applied to the chroma input and calculate the ratio between them. $ACCM2 = 20\log(-20dBdata/0dBdata)$	Color: 1000000
Demodulation output ratio R-Y/B-Y: PAL	RB_P	21 19	C-1	Refer to 5. and measure Bout output amplitude Vb and ROUT output amplitude Vr. And calculate $RB = Vr/Vb$.	Color: 1000000
Demodulation output ratio G-Y/B-Y: PAL	GB_P	21 19	C-4	Measure Bout output amplitude Vbp and GOUT output amplitude Vgbp. And calculate $GB_P = Vgbp/Vbp$.	Color: 1000000

Continued on next page.

LA76810A

Continued from preceding page.

Input signal	Symbol	Test point	Input signal	Test method	Bus bit/input signal
Demodulation output ratio G-Y/R-Y: PAL	GR_P	20 19	C-5	Measure Rout output amplitude Vrp and GOUT output amplitude Vgpb. And calculate $GR_P = Vgpb/Vrp$.	Color: 1000000
Demodulation angle B-Y/R-Y: PAL	ANGBR_P	21 19	C-1	Refer to 5. and measure the B-Y and R-Y demodulation angle and calculate.	Color: 1000000
APC pull-in range (+)	PULIN+_P	21	C-1	Decrease the chroma fsc frequency from 4.433619MHz+1000Hz and measure the frequency at which the VCO locks.	
APC pull-in range (-)	PULIN-_P	21	C-1	Increase the chroma fsc frequency from 4.433619MHz-1000Hz and measure the frequency at which the VCO locks.	

[Chroma block]: NTSC

Input signal	Symbol	Test point	Input signal	Test method	Bus bit/input signal
ACC amplitude characteristics 1	ACCM1_N	Bout 21	C-1 0dB +6dB	Measure the output amplitude when 0dB is applied to the chroma input and the output amplitude when +6dB is applied to the chroma input and calculate the ratio between them. $ACCM1 = 20\text{LOG} (+6\text{dBdata}/0\text{dBdata})$	
ACC amplitude characteristics 2	ACCM2_N	Bout 21	C-1 -20dB	Measure the output amplitude when 20dB is applied to the chroma input and calculate the ratio between them. $ACCM2 = 20\text{LOG} (-20\text{dBdata}/0\text{dBdata})$	
R-Y/B-Y: NTSC Demodulation output ratio R-Y/B-Y: NTSC	RB_N	21 19	C-1	Refer to 5. and measure Bout output amplitude Vb and ROUT output amplitude Vr. And calculate $RB = Vr/Vb$.	Color: 1000000
G-Y/B-Y: NTSC Demodulation output ratio R-Y/B-Y: NTSC	GB_N	20	C-1	Refer to 5. and measure GOUT output amplitude Vg. And calculate $GB_N = Vg/Vb$.	Color: 1000000
Demodulation angle B-Y/R-Y: NTSC	ANGBR_N	21 19	C-1	Refer to 5. and measure the B-Y and R-Y demodulation angle and calculate. Reference: B-Y angle	Color: 1000000
Demodulation angle G-Y/B-Y: NTSC	ANGGB_N	21 20	C-1	Refer to 5. and measure the B-Y and G-Y demodulation angle and calculate. Reference: B-Y angle	Color: 1000000
Killer operating point	KILL_N	21	C-1	Reduce the input signal until the output level becomes 150mVp-p or less. Measure the input level at that moment.	
APC pull-in range (+)	PULIN+_N	21	C-1	Decrease the chroma fsc frequency from 3.579545MHz+1000Hz and measure the frequency at which the VCO locks.	
APC pull-in range (-)	PULIN-_N	21	C-1	Increase the chroma fsc frequency from 3.579545MHz-1000Hz and measure the frequency at which the VCO locks.	
Tint center	TINCEN	21	C-1	Measure each part of the output level and calculate the B-Y axis angle.	TINT: 1000000

Continued on next page.

LA76810A

Continued from preceding page.

Input signal	Symbol	Test point	Input signal	Test method	Bus bit/input signal
Tint variable range (+)	TINT+	21	C-1	Measure each part of the output level and calculate the B-Y axis angle. TINT+ = B-Y axis angle -TINCEN	TINT 1111111
Tint variable range (-)	TINT-	21	C-1	Measure each part of the output level and calculate the B-Y axis angle. TINT- = B-Y axis angle -TINCEN	TINT 0000000

[Filter Block Chroma BPF Characteristic]

Input signal	Symbol	Test point	Input signal	Test method	Bus bit/input signal
C-BPF1A Peaker amplitude characteristic 3.93MHz	CBPF1A	21	C-3 PAL signal	Set the chroma frequency (CW) to 4.433619MHz-100kHz and measure V0 output amplitude. And then, set the chroma frequency (CW) to 3.93MHz and measure V1 output amplitude to calculate as follows: $CBPF1A = 20\text{LOG} (V1/V0)$	FILTER SYS = 0010 C.BYPASS = 0
C-BPF1B Peaker amplitude characteristic 4.73/4.13MHz	CBPF1B	21	C-3 PAL signal	Measure V2 output amplitude when the chroma frequency (CW) is 4.13MHz and V3 output amplitude when it (CW) is 4.73MHz to calculate as follows: $CBPF1B = 20\text{LOG} (V3/V2)$	FILTER SYS = 0010 C.BYPASS = 0
C-BPF1C Peaker amplitude characteristic 4.93/3.93MHz	CBPF1C	21	C-3 PAL signal	Set the chroma frequency (CW) to 4.93MHz and measure V4 output amplitude to calculate as follows: $CBPF1C = 20\text{LOG} (V4/V1)$	FILTER SYS = 0010 C.BYPASS = 0
C-BPF2A BandPass amplitude characteristic 3.93MHz	CBPF2A	21	C-3 PAL signal	Set the chroma frequency (CW) to 4.433619MHz-100MHz and measure V00 output amplitude. And then, set the chroma frequency (CW) to 3.93MHz and measure V10 output amplitude to calculate as follows: $CBPF2A = 20\text{LOG} (V10/V00)$	FILTER SYS = 0011 C.BYPASS = 0
C-BPF2B BandPass amplitude characteristic 4.73/4.13MHz	CBPF2B	21	C-3 PAL signal	Measure V20 output amplitude when the chroma frequency (CW) is 4.13MHz and V30 output amplitude when it (CW) is 4.73MHz to calculate as follows: $CBPF2B = 20\text{LOG} (V30/V20)$	FILTER SYS = 0011 C.BYPASS = 0
C-BPF2C BandPass amplitude characteristic 4.93/3.93MHz	CBPF2C	21	C-3 PAL signal	Set the chroma frequency (CW) to 4.93MHz and measure V40 output amplitude to calculate as follows: $CBPF2C = 20\text{LOG} (V40/V10)$	FILTER SYS = 0011 C.BYPASS = 0

Deflection Block Input Signals and Test Conditions

Unless otherwise specified, the following conditions apply when each measurement is made.

1. VIF, SIF blocks: No signal
2. C input: No. signal
3. Sync input: A horizontal/vertical composite sync signal

PAL: 43IRE, horizontal sync signal (15.625kHz) and vertical sync signal (50kHz)

NTSC: 40IRE, horizontal sync signal (15.734264kHz) and vertical sync signal (59.94kHz)

Note: No burst signal, chroma signal shall exist below the pedestal level.

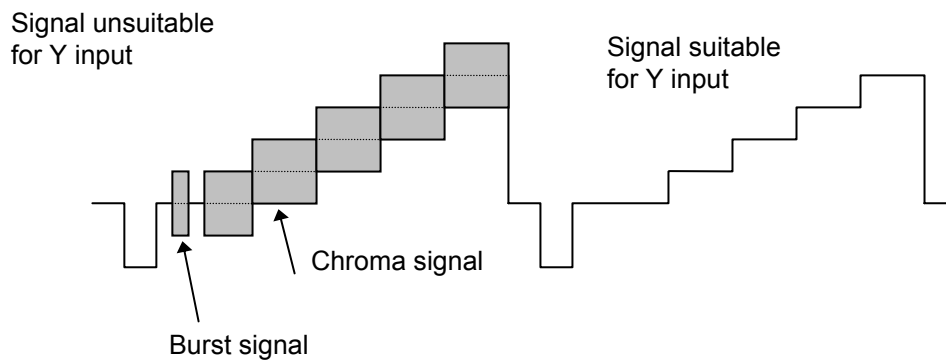

4. Bus control conditions: Initial conditions unless otherwise specified.
5. The delay time from the rise of the horizontal output (pin 27 output) to the fall of the FBP IN (pin 28 input) is $9\mu\text{s}$.
6. Pin 13 (vertical size correction circuit input terminal) is connected to V_{CC} (5.0V).

LA76810A

Deflection Block Test Conditions

Input signal	Symbol	Test point	Input signal	Test method	Bus bit/input signal
Horizontal free-running frequency	fH	27	Y IN: No signal	Connect a frequency counter to the output of pin 27 (H out) and measure the horizontal free-running frequency.	
Horizontal pull-in range	fH PULL	42	Y IN: Horizontal/ vertical sync signal PAL	Using an oscilloscope, monitor the horizontal sync signal which is input to the Y IN (pin 42) and the pin 27 output (H out) and vary the horizontal signal frequency to measure the pull-in range.	
Horizontal output pulse length	Hduty	27	Y IN: Horizontal/ vertical sync signal PAL	Measure the voltage for the pin 27 horizontal output pulse's low-level period.	
Horizontal output pulse saturation voltage	V Hsat	27	Y IN: Horizontal/ vertical sync signal PAL	Measure the voltage for the pin 27 horizontal output pulse's low-level period.	
Vertical free-running period 50 (PAL) Vertical free-running period 60 (NTSC)	VFR50 VFR60	23	Y IN: No signal	Measure the vertical output period T at pin 18 T×15.625kHz (PAL) T×15.734kHz (NTSC)	CDMODE: 001 (PAL) CDMODE: 002 (NTSC)
Horizontal output pulse	HPHCEN (PAL) (NTSC)	27 42	Y IN: Horizontal/ vertical sync signal PAL NTSC	Measure the delay time from the rise of the pin 27 horizontal output pulse to the fall of the Y IN horizontal sync signal.	
Horizontal position adjustment range	HPHrange	27 42	Y IN: Horizontal/ vertical sync signal PAL	With H PHASE: 0 and 31, measure the delay time from the rise of the pin 27 horizontal output pulse to the fall of the Y IN horizontal sync signal and calculate the difference from H PHCEN.	H PHASE: 0000 H PHASE: 11111

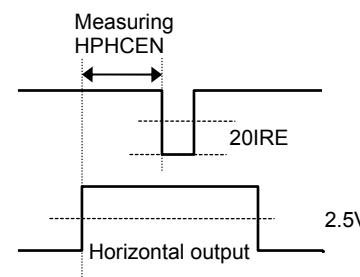
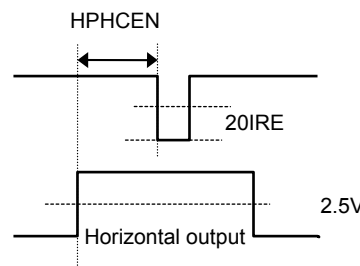
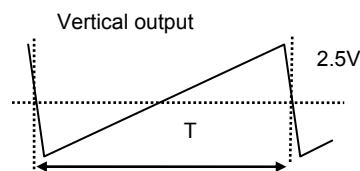

Continued on next page.

LA76810A

Continued from preceding page.

Input signal	Symbol	Test point	Input signal	Test method	Bus bit/input signal
Horizontal position adjustment maximum variable width	HPHstep	<div style="border: 1px solid black; width: 30px; height: 30px; text-align: center; margin-bottom: 5px;">27</div> <div style="border: 1px solid black; width: 30px; height: 30px; text-align: center;">42</div>	Y IN: Horizontal/ vertical sync signal PAL	With H PHASE: 0 to 31 varied, measure the delay time from to the rise of the pin 27 horizontal output pulse to the fall of the Y IN horizontal sync signal and calculate the variation at each step. Retrieve data for maximum variation. 	H PHASE: 00000 to H PHASE: 11111
POR circuit operating voltage	VPOR	<div style="border: 1px solid black; border-radius: 50%; width: 30px; height: 30px; text-align: center; line-height: 30px;">25</div>	Y IN: Horizontal/ vertical sync signal PAL	Connect a DC power supply in place of the current source to pin 25 and gradually decrease the voltage from 5.0V until the BUS READ TATUS [POR][STATUS1 (DA01) becomes "1". Measure the DC voltage at pin 25 at the moment.	
Horizontal blanking left variable range@0	BLKL0	<div style="border: 1px solid black; width: 30px; height: 30px; text-align: center; margin-bottom: 5px;">21</div> <div style="border: 1px solid black; width: 30px; height: 30px; text-align: center;">42</div>	Y IN: Horizontal/ vertical sync signal PAL	Measure the time T from the left end of Hsync at pin 42 Y IN to the left end of blanking at pin 21 BlueOUT with BLKL = 000. 	BLKL: 000
Horizontal blanking left variable range@7	BLKL7	<div style="border: 1px solid black; width: 30px; height: 30px; text-align: center; margin-bottom: 5px;">21</div> <div style="border: 1px solid black; width: 30px; height: 30px; text-align: center;">42</div>	Y IN: Horizontal/ vertical sync signal PAL	Measure the time T from the left end of Hsync at pin 42 Y IN to the left end of blanking at pin 21 BlueOUT with BLKL = 111. 	BLKL: 111

Continued on next page.

LA76810A

Continued from preceding page.

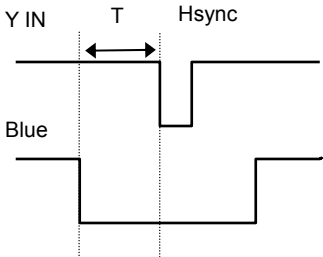
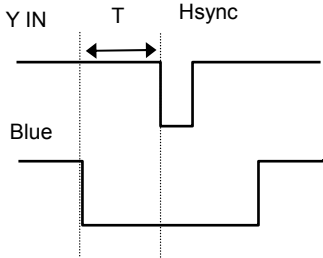
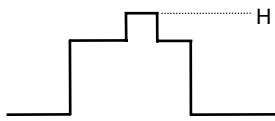
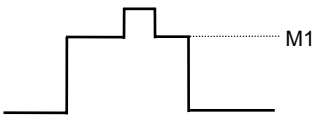
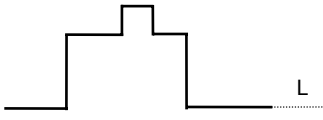
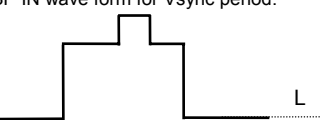
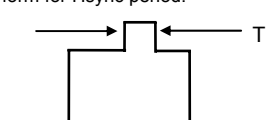
Input signal	Symbol	Test point	Input signal	Test method	Bus bit/input signal
Horizontal blanking right variable range@0	BLKR0	21 42	Y IN: Horizontal/ vertical sync signal PAL	Measure the time T from the left end of Hsync at pin 42 Y IN to the left end of blanking at pin 21 BlueOUT with BLKR = 000. 	BLKR: 000
Horizontal blanking right variable range@7	BLKR7	21 42	Y IN: Horizontal/ vertical sync signal PAL	Measure the time T from the left end of Hsync at pin 42 Y IN to the left end of blanking at pin 21 BlueOUT with BLKR = 111. 	BLKR: 111
Sand castle pulse crest value H	SANDH	28	Y IN: Horizontal/ vertical sync signal PAL	Measure the supply voltage at point H of the pin 28 FBP IN wave form for Hsync period. 	
Sand castle pulse crest value M1	SANDM1	28	Y IN: Horizontal/ vertical sync signal PAL	Measure the supply voltage at point M1 of the pin 28 FBP IN wave form for Hsync period. 	
Sand castle pulse crest value L	SANDL	28	Y IN: Horizontal/ vertical sync signal PAL	Measure the supply voltage at point L of the pin 28 FBP IN wave form for Hsync period. 	
Sand castle pulse crest value M2	SANDM2	28	Y IN: Horizontal/ vertical sync signal PAL	Measure the supply voltage at point M2 of the pin 28 FBP IN wave form for Vsync period. 	
Burst gate pulse length	BGPWD	28	Y IN: Horizontal/ vertical sync signal PAL	Measure the BGP width T of the pin 28 FBP IN wave form for Hsync period. 	

Continued on next page.

LA76810A

Continued from preceding page.

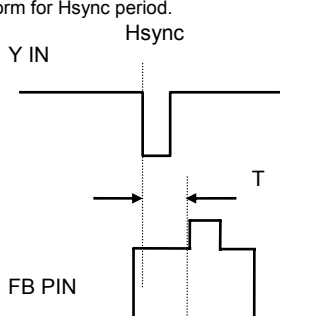
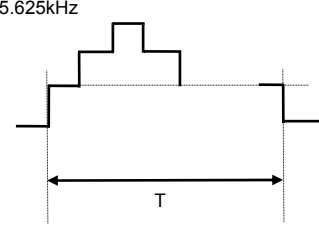
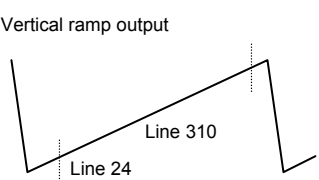
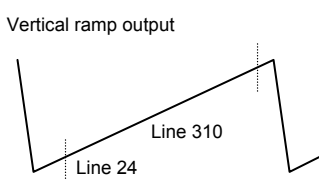
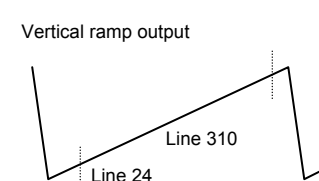
Input signal	Symbol	Test point	Input signal	Test method	Bus bit/input signal
Burst gate pulse I phase	BGPPH	28 42	Y IN: Horizontal/ vertical sync signal PAL	Measure the time from the left end of Hsync at pin 42 Y IN to the left end of the pin 28 FBP IN wave form for Hsync period. 	
SECAM V pulse length	SECAMV	28	Y IN: Horizontal/v ertical sync signal PAL	Measure the SECAM V pulse length T of the pin 28 FBPIN wave form. Calculate as: $T(s) \times 15.625\text{kHz}$ 	
<Vertical screen size correction>					
Vertical ramp output Amplitude PAL@64 NTSC@64	Vspal64 Vsnt64	23	Y IN: Horizontal/ vertical sync signal PAL NTSC	Monitor the pin 23 vertical ramp output and measure the voltage at line 24 and line 310. Calculate as follows: $V_{spal64} = V_{line310} - V_{line24}$ $V_{snt64} = V_{line262} - V_{line22}$ 	
Vertical ramp output amplitude PAL@0	Vspal0	23	Y IN: Horizontal/ vertical sync signal PAL	Monitor the pin 23 vertical ramp output and measure the voltage at line 24 and line 310 Calculate as follows: $V_{spal0} = V_{line310} - V_{line24}$ 	VSIZE: 0000000
Vertical ramp output amplitude PAL@127	Vspal127	23	Y IN: Horizontal/ vertical sync signal PAL	Monitor the pin 23 vertical ramp output and measure the voltage at line 24 and line 310 Calculate as follows: $V_{spal27} = V_{line310} - V_{line24}$ 	VSIZE: 1111111

Continued on next page.

LA76810A

Continued from preceding page.

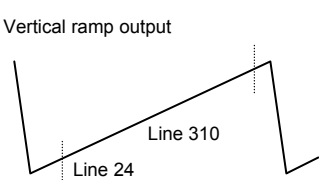
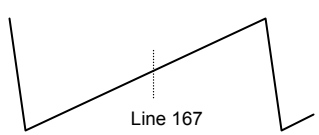
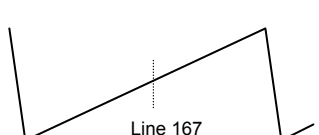
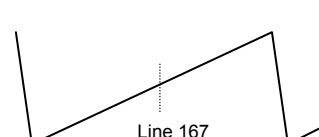
Input signal	Symbol	Test point	Input signal	Test method	Bus bit/input signal
<High-voltage dependent vertical size correction>					
Vertical size correction@0	Vsizecomp		Y IN: Horizontal/ vertical sync signal PAL	Monitor the pin 23 vertical ramp output and measure the voltage at the line 24 and line 310 with VCOMP = 000. Calculate as follows: $V_a = V_{line310} - V_{line24}$ Apply 4.1V to pin 13 and measure the voltage at the line 24 and line 310 again. Calculate as follows: $V_a = V_{line310} - V_{line24}$ Calculate as follows: $V_{sizecomp} = V_b / V_a$ 	VCOMP: 000
<Vertical screen position adjustment>					
Vertical ramp DC voltage PAL@32 NTSC@32	Vdcpal32 Vdcnt32	23	Y IN: Horizontal/ vertical sync signal PAL NTSC	Monitor the pin 23 vertical ramp output and measure the voltage at line 167. (PAL) Monitor the pin 23 vertical ramp output and measure the voltage at line 142. (NTSC) 	
Vertical ramp DC voltage PAL@0	Vdcpal0	23	Y IN: Horizontal/ vertical sync signal PAL	Monitor the pin 23 vertical ramp output and measure the voltage at line 167. 	VDC: 000000
Vertical ramp DC voltage PAL@63	Vdcpal63	23	Y IN: Horizontal/ vertical sync signal PAL	Monitor the pin 23 vertical ramp output and measure the voltage at line 167. 	VDC: 111111

Continued on next page.

LA76810A

Continued from preceding page.

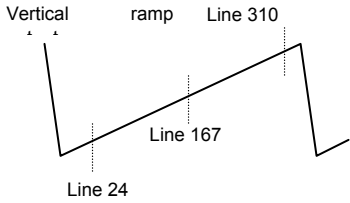
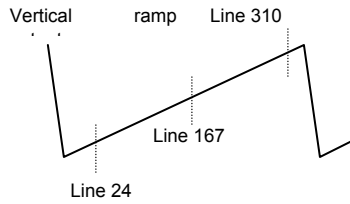
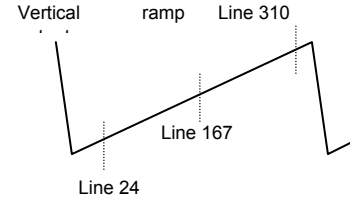
Input signal	Symbol	Test point	Input signal	Test method	Bus bit/input signal
Vertical linearity@16	Vlin16	23	Y IN: Horizontal/ vertical sync signal PAL	Monitor the pin 23 vertical ramp output and measure the voltage at line 24, line 167 and 310. Assign the respective measured values to Va, Vb and Vc. Calculate as follows: $Vlin16 = (Vb-Va)/(Vc-Vb)$ 	
Vertical linearity@0	Vlin0	23	Y IN: Horizontal/ vertical sync signal PAL	Monitor the pin 23 vertical ramp output and measure the voltage at line 24, line 167 and 310. Assign the respective measured values to Va, Vb and Vc. Calculate as follows: $Vlin0 = (Vb-Va)/(Vc-Vb)$ 	VLIN: 00000
Vertical linearity@31	Vlin31	23	Y IN: Horizontal/ vertical sync signal PAL	Monitor the pin 23 vertical ramp output and measure the voltage at line 24, line 167 and 310. Assign the respective measured values to Va, Vb and Vc. Calculate as follows: $Vlin31 = (Vb-Va)/(Vc-Vb)$ 	VLIN: 11111

Continued on next page.

LA76810A

Continued from preceding page.

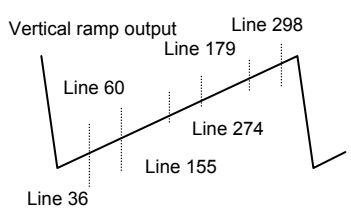
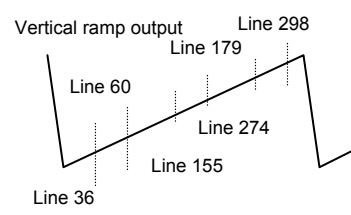
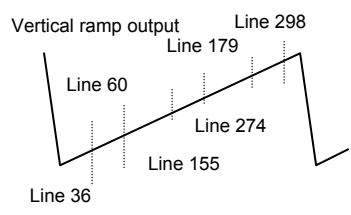
Input signal	Symbol	Test point	Input signal	Test method	Bus bit/input signal
Vertical S-shaped correction @16	VScor16	15	Y IN: Horizontal/ vertical sync signal PAL	<p>Monitor the pin 23 vertical ramp output and measure the voltage at line 36, line 60, line 155, line 179, line 274 and 298. Assign the respective measured values to Va, Vb, Vc, Vd, Ve and Vf. Calculate as follows: $VScor16 = 0.5((Vb-Va)+(Vf-Ve))/(Vd-Vc)$</p> 	VSC: 10000
Vertical S-shaped correction @0	VScor0	23	Y IN: Horizontal/ vertical sync signal PAL	<p>Monitor the pin 23 vertical ramp output and measure the voltage at the line 36, line 60, line 155, line 179, line 274 and line 298 with VSC = 00000. Assign the respective measured values to Va, Vb, Vc, Vd, Ve and Vf. Calculate as follows: $VScor0 = 0.5((Vb-Va)+(Vf-Ve))/(Vd-Vc)$</p> 	
Vertical S-shaped correction @31	VScor31	23	Y IN: Horizontal/ vertical sync signal PAL	<p>Monitor the pin 23 vertical ramp output and measure the voltage at line 36, line 60, line 155, line 179, line 274 and 298. Assign the respective measured values to Va, Vb, Vc, Vd, Ve and Vf. Calculate as follows: $VScor16 = 0.5((Vb-Va)+(Vf-Ve))/(Vd-Vc)$</p> 	VSC: 11111

LA76810A

Control Register Bit Allocation Map

Control Register Bit Allocations									
Sub Address	MSB		DATA BITS					LSB	
	DA0	DA1	DA2	DA3	DA4	DA5	DA6	DA7	
00000000	T.Disable	AFC gain&gate	H.FREQ						
	1	0	1	1	1	1	1	1	
00001	H BLK SW	Audio.Mute	Video.Mute	H.PAHSE					
	0	0	0	1	0	0	0	0	
00010	Sync.Kill	V.SIZE							
	0	1	0	0	0	0	0	0	
00011	VSEPUF	V.KILL	V.POSI						
	0	0	1	0	0	0	0	0	
00100	Gray Mode	Cross B/W		V.LIN					
	0	0	0	1	0	0	0	0	
00101	H BLK R&L			V.SC					
	1	0	0	0	0	0	0	0	
00110	V.TEST		V.COMP				COUNT.DOWN.MODE		
	0	0	1	1	1	0	0	0	
00111	R.BIAS								
	0	0	0	0	0	0	0	0	
01000	G.BIAS								
	0	0	0	0	0	0	0	0	
01001	B.BIAS								
	0	0	0	0	0	0	0	0	
01010	*	R.DRIVE							
	(0)	1	1	1	1	1	1	1	
01011	Drive.Test	B γ Select		RG γ Def	G.DRIVE				
	0	0	0	1	1	0	0	0	
01100	*	B.DRIVE							
	(0)	1	1	1	1	1	1	1	
01101	Blank.Def	Sub.Bright							
	0	1	0	0	0	0	0	0	
01110	*	Bright							
	(0)	1	0	0	0	0	0	0	
01111	*	Contrast							
	(0)	1	0	0	0	0	0	0	
10000	OSD Cnt.Test	OSD Contrast							
	0	1	0	0	0	0	0	0	
10001	Blk.Str.Deff	Coring	Sharpness						
	1	1	0	0	0	0	0	0	
10010	Tint.Test	Tint							
	0	1	0	0	0	0	0	0	
10011	Color.Test	Color							
	0	1	0	0	0	0	0	0	
10100	Video SW	(Trap.Test)			Filter.Sys				
	0	1	0	0	0	0	1	0	
10101	AKB B/W	AKB Def	C.Temp.R						
	0	0	1	0	0	0	0	0	
10110	*	FBPBLK.SW	C.TEMP.G						
	(0)	1	1	0	0	0	0	0	
10111	AKB Test		C.TEMP.B						
	0	0	1	0	0	0	0	0	

Continued on next page.

LA76810A

Continued from preceding page.

Sub Address	MSB				DATA BITS			LSB
	DA0	DA1	DA2	DA3	DA4	DA5	DA6	DA7
00011000	Auto.Flesh	C.Ext	C.Bypass	C_Kill ON	C_Kill OFF	Color.Sys		
	0	0	1	0	0	0	0	0
11001	Cont.Test	Digital OSD	Brt.Abl.Def	Mid.Stp.Def	Emg.Abl.Def	Bright.Abl.Threshold		
	0	0	0	0	0	1	0	0
11010	R-Y/B-Y Gain Balance				R-Y/B-Y Angle			
	1	0	0	0	1	0	0	0
11011	SECAM B-Y DC Level (White-Balance)				SECAM R-Y DC Level (White-Balance)			
	1	0	0	0	1	0	0	0
11100	Audio SW	Volume						
	0	0	0	0	0	0	0	0
11101	FM.Test	VOL.FIL	RF.AGC					
	0	0	1	0	0	0	0	0
11110	FM.Mute	deem.TC	VIF.Sys.SW		SIF.Sys.SW		FM.Gain	IF.AGC
	0	0	0	1	0	1	0	0
11111	VIDEO.LEVEL			FM.LEVEL				
	1	0	0	1	0	0	0	0

Status Register Bit Allocations

	MSB				DATA BITS			LSB
	DA0	DA1	DA2	DA3	DA4	DA5	DA6	DA7
Status1	(X.Ray)	POR	IF.Ident	RF.AGC	IF.LOCK	V.TRI	50/60	ST/NONST
	*	*	*	*	*	*	*	*
Status2	H.Lock	(AKB)			*	Color.Sys		
	*	R	G	B	(0)	*	*	*

www.DataSheet4U.com

LA76810A

Control Register Truth Table

Register Name	0 HEX	1 HEX	2 HEX	3 HEX
T.Disable	Tset Enable	Test Disable		
AFC gain&gate	Auto (Gain)	Gain:Fast		
	Auto (Gate)	Non-Gate		
H BLK SW	Right Control	Left Control		
Audio.Mute	Active	Mute		
Video.Mute	Active	Mute		
Sync.Kill	Sync active	Sync killed		
Vsepup	normal	Vsepup		
V.KILL	Vrt active	Vrt killed		
Gray Mode	Normal	Gray OSD		
Cross B/W	Normal	Black	White	Cross
Vertical Test	Normal	Vrt S Corr	Vrt Lin	Vrt Size
Drive.Test	Normal	Test Mode		
B Gamma Select	B Gamma on 85% (same as R,G)	B Gamma on 90%	B Gamma on 95%	B Gamma off
R/G Gamma. Def	Gamma	Linear		
Blank.Def	Blanking	No Blank		
OSD Cnt.Test	Normal	Test Mode		
Blk.Str.Deff	Blk Str On	Blk Str Off		
Coring	Core Off	Core On		
Tint.Test	Normal	Test Mode		
Color.Test	Normal	Test Mode		
Video.SW	Internal Mode	External Mode		
(AKB B/W)	AKB Black	AKB White		
(AKB Def)	AKB On	AKB Off		
FBPBLK.SW	FBP not or	FBP or		
(AKB Test)	Normal	Test Mode1	Test Mode2	Test Mode3
Auto.Flesh	AF Off	AF On		
C.Ext	Internal Mode	External Mode		
C.Bypass	Bypass OFF	Bypass ON		
C_Kill ON	Auto Mode	Killer ON		
C_Kill OFF	Auto Mode	Killer OFF		
Cont.Test	Normal	Test Mode		
Emg.Abl.Def	Emg On	Emg Off		
Br.t.Abl.Def	Br.t ABL On	Br.t ABL Off		
Mid.Stp.Def	Mid Stp On	Mid Stp Off		
Audio.SW	Internal Mode	External Mode		
FM.Test	Normal	Test Mode		
VOL.FIL	Normal	Filte OFF		
FM.Mute	Active	Mute		
de-em TC.	50µs	75µs		
VIF.Sys.SW	38.0MHz	38.9MHz	45.75MHz	39.5MHz
SIF.Sys.SW	4.5MHz	5.5MHz	6.0MHz	6.5MHz
FM Gain (@1000mVrms)	50kHz dev.	25kHz dev		
IF.AGC	AGC active	AGC defeat		

LA76810A

Control Register Truth Table

COUNT DOWN MODE

	50Hz/60Hz MODE	Standard/Non-Standard MODE
0 HEX	Auto	Auto
1 HEX	50Hz	Auto
2 HEX	60Hz	Auto
3 HEX	Auto	Auto
4 HEX	Auto	Non-Standard
5 HEX	50Hz	Non-Standard
6 HEX	60Hz	Non-Standard
7 HEX	Auto	Non-Standard

Color System

0 HEX	Auto Mode1 PAL/NTSC/4.43NTSC(/SECAM)
1 HEX	Auto Mode2 PAL-M/PAL-N/NTSC
2 HEX	PAL
3 HEX	PAL-M
4 HEX	PAL-N
5 HEX	NTSC
6 HEX	4.43NTSC
7 HEX	SECAM

Filter System

	Y Filter	Chroma Filter
0 HEX	3.58MHz Trap	Peaked 3.58MHz BPF
1 HEX	3.58MHz Trap	Symmetrical 3.58MHz BPF
2 HEX	4.43MHz Trap	Peaked 4.43MHz BPF
3 HEX	4.43MHz Trap	Symmetrical 4.43MHz BPF
4 HEX	No Trap (Wide Band mode)	Peaked 3.58MHz BPF
5 HEX	No Trap (Wide Band mode)	Symmetrical 3.58MHz BPF
6 HEX	No Trap (Wide Band mode)	Peaked 4.43MHz BPF
7 HEX	No Trap (Wide Band mode)	Symmetrical 4.43MHz BPF
8-15HEX	4.286MHz Trap	Symmetrical 4.43MHz BPF

LA76810A

Initial Conditions

Initial Test Conditions	
Register	
ON/OFF(T.Disable)	1 HEX
AFC gain&gate	0 HEX
H.FREQ	3F HEX
H BLK SW	0 HEX
Audio.Mute	0 HEX
Video.Mute	0 HEX
H.PHASE	10 HEX
Sync.Kill	0 HEX
V.SIZE	40 HEX
VSEPUP	0 HEX
V.KILL	0 HEX
V.POSI	20 HEX
Gray Mode	0 HEX
Cross B/W	0 HEX
V.LIN	10 HEX
H BLK R&L	4 HEX
V.SC	00 HEX
V.TEST	0 HEX
V.COMP	7 HEX
COUNT.DOWN.MODE	0 HEX
R.BIAS	00 HEX
G.BIAS	00 HEX
B.BIAS	00 HEX
R.DRIVE	7F HEX
Drive. Test	0 HEX
B Gamma Select	0 HEX
R/G Gamma.Def	1 HEX
G.DRIVE	8 HEX
B.DRIVE	7F HEX
Blank.Def	0 HEX
Sub.Bright	40 HEX
Bright	40 HEX
Contrast	40 HEX

Initial Test Conditions (continued)	
Register	
OSD Cnt.Test	0 HEX
OSD Contrast	0 HEX
Blk.Str.Def	1 HEX
Coring	1 HEX
Sharpness	00 HEX
Tint.Test	0 HEX
Tint	40 HEX
Color.Test	0 HEX
Color	40 HEX
Video.SW	0 HEX
(Trap.Test)	4 HEX
Filter.Sys	0 HEX
AKB B/W	0 HEX
AKB Def	0 HEX
C.Temp.R	20 HEX
FBPBLK.SW	1 HEX
C.Temp.G	20 HEX
AKB Test	0 HEX
C.Temp.B	20 HEX
Auto.Flesh	0 HEX
C.Ext	0 HEX
C.Bypass	1 HEX
C_Kill ON	0 HEX
C_Kill OFF	0 HEX
Color Sys	0 HEX
Cont.Test	0 HEX
Digitsl OSD	0 HEX
Bright.Abl.Threshold	4 HEX
Emg.Abl.Def	0 HEX
Brn.Abl.Def	0 HEX
Mid.Stp.Def	0 HEX
R-Y/B-Y Gain Balance	8 HEX
R-Y/B-Y Angle	8 HEX
SECAM B-Y DC Level	8 HEX
SECAM R-Y DC Level	8 HEX
Audio.SW	0 HEX
Volume	00 HEX
FM.Test	0 HEX
VOL.FIL	0 HEX
RF.AGC	20 HEX
FM.Mute	0HEX
deem.TC	0HEX
VIF.Sys.SW	1 HEX
SIF.Sys.SW	1 HEX
FM.Gain	0 HEX
IF.AGC	0 HEX
VIDEO.LEVEL	4 HEX
FM.LEVEL	10 HEX

LA76810A

Control Register Descriptions

Register Name	Bits	General Description
T Disable	1	Disable the Test SW & enable Audio/Video Mute SW
AFC Gain & gate	1	Select horizontal first loop gain & H-sync gating on/off
H Freq.	6	Align ES Sample horizontal frequency
H.BLK.SW	1	Blanking Control (Right/Left)
Audio Mute	1	Disable audio outputs
Video Mute	1	Disable video outputs
H PHASE	5	Align sync to flyback phase
Sync Kill	1	Force free-run mode
Vertical Size	7	Align vertical amplitude
Vsep.up	1	Select vertical sync. separation sensitivity
Vertical Kill	1	Disable vertical output
V POSI (Vertical DC)	6	Align vertical DC bias
Gray Mode	1	OSD Gray Tone Enable
Cross B/W	2	Service Test Mode (normal/Black/White/Cross)
V LIN (Vertical Linearity)	5	Align vertical linearity
H BLK R&L	3	H-Blanking Control (Width/Phase)
Vertical S-Correction	5	Align vertical S-correction
Vertical Test	2	Select vertical DAC test modes
Vertical Size Compensation	3	Align vertical size compensation
Count Down Mode	3	Select vertical countdown mode
Red Bias	8	Align Red OUT DC level
Green Bias	8	Align Green OUT DC level
Blue Bias	8	Align Blue OUT DC level
Red Drive	7	Align Red OUT AC level
Drive Test	1	Enable Drive control DAC test modes
B Gamma Select	2	Select Blue Gamma Gain
R/G Gamma Defeat	1	Disable R/G Gamma Correction
Green Drive	4	Align Green OUT AC level
Blue Drive	7	Align Blue OUT AC level
Blank Def	1	Disable RGB output blanking
Sub Brightness	7	Align common RGB DC level
Brightness Control	7	Customer brightness control
Contrast Control	7	Customer contrast control
OSD Contrast Test	1	Enable OSD Contrast DAC test mode
OSD Contrast Control	7	Align OSD AC level
Blk Str Def	1	Disable black stretch
Coring Enable	1	Enable luminance coring
Sharpness Control	6	Customer sharpness control
Tint Test	1	Enable tint DAC test mode
Tint Control	7	Customer tint control
Color Test	1	Enable color DAC test mode
Color Control	7	Customer color control
Video SW	1	Select Video source
Trap.Test	3	Trap Test
Filter System	4	Select Y/C Filter mode
(AKB B/W)	1	Select AKB Black or White
(AKB Def)	1	Disable AKB circuits

Continued on next page.

LA76810A

Continued from preceding page.

Control Register Descriptions		
Register Name	Bits	General Description
C Temp R	6	Align AKB color temperature
FBPBLK.SW	1	Enable RGB Blanking or FBP
C Temp G	6	Align AKB color temperature
(AKB Test)	2	Enable AKB C Temp. DAC test mode
C Temp B	6	Align AKB color temperature
AutoFlesh	1	Enable AutoFlesh function
C Ext	1	Selected-C In SW on
C Bypass	1	Select Chroma BPF bypass
C Kill On	1	C Kill Mode (1: Enable Killer circuit)
C Kill Off	1	Disable Killer circuit
Color System	3	Select Color System
Cont Test	1	Enable contrast DAC test mode
Bright ABL Threshold	3	Align brightness ABL threshold
Emergency ABL Defeat	1	Disable emergency brightness ABL
Bright ABL Defeat	1	Disable brightness ABL
Bright Mid Stop Defeat	1	Disable brightness mid stop
R-Y/B-Y Balance	4	R-Y/B-Y Gain Balance
R-Y/B-Y Angle	4	R-Y/B-Y Angle
SECAM B-Y DC Level	4	SECAM B-Y DC Level (White-Balance)
SECAM R-Y DC Level	4	SECAM R-Y DC Level (White-Balance)
Audio SW	1	Select Audio source
Volume Control	7	Customer volume control
FM.Test	1	FM.Test
Volume Filter Defeat	1	Disable volume DAC filter
RF AGC Delay	6	Align RF AGC threshold
FM Mute	1	Disable FM outputs
de-em TC.	1	Select de-emphasis Time Constant
VIF System SW	2	Select 38.0/38.9/39.5/45.75
SIF System SW	2	Select 4.5/5.5/6.0/6.5
FM Gain	1	Select FM Output Level
IF AGC Defeat	1	Disable IF and RF AGC
Video Level	3	Align IF video level
FM Level	5	Align WBA output level

LA76810A

Pin Assignment

PIN	FUNCTION	PIN	FUNCTION
1	Audio Output	54	SIF Input
2	FM Output	53	SIF APC Filter
3	PIF AGC	52	SIF Output
4	RF AGC Output	51	Ext. Audio Input
5	PIF Input1	50	APC Filter
6	PIF Input2	49	VCO Coil 1
7	IF Ground	48	VCO Coil 2
8	IF V _{CC}	47	VCO Filter
9	FM Filter	46	Video Output
10	AFT Output	45	Black Level Detector
11	Bus Data	44	Internal Video Input (S-C IN)
12	Bus Clock	43	Video/Vertical V _{CC}
13	ABL	42	External Video Input (Y IN)
14	Red Input	41	Video/Vertical/BUS Ground
15	Green Input	40	Selected Video Output
16	Blue Input	39	Chroma APC1 Filter
17	Fast Blanking Input	38	4.43MHz Crystal
18	RGB V _{CC}	37	fsc (4.43MHz) Output
19	Red Output	36	ACC Filter
20	Green Output	35	SECAM R-Y Input
21	Blue Output	34	SECAM B-Y Input
22	Sync Sep Output	33	CCD/Horizontal Ground
23	Vertical Output	32	CCD Filter
24	Ramp ALC Filter	31	CCD V _{CC}
25	Horizontal/BUS V _{CC}	30	Clock (4MHz) Output
26	Horizontal AFC Filter	29	VCO IREF
27	Horizontal Output	28	Flyback Pulse Input

LA76810A

BUS DATA

Register	TR	BIT	INTIAL	MAX	MIN
T.Disable	0	1	1	1	0
AFC gain&gate	0	1	0	1	0
H.FREQ	0	6	63	63	0
H BLK SW	1	1	0	1	0
Audio.Mute	1	1	0	1	0
Video.Mute	1	1	0	1	0
H.PHASE	1	5	16	31	0
Sync.Kill	2	1	0	1	0
V.SIZE	2	7	64	127	0
VSEPUP	3	1	0	1	0
V.KILL	3	1	0	1	0
V.POSI	3	6	32	63	0
Gray.Mode	4	1	0	1	0
Cross B/W	4	2	0	3	0
V.LIN	4	5	16	31	0
H BLK R&L	5	3	4	7	0
V.SC	5	5	0	31	0
V.TEST	6	2	0	3	0
V.COMP	6	3	7	7	0
COUNT.DOWN.MODE	6	3	0	7	0
R.BIAS	7	8	0	255	0
G.BIAS	8	8	0	255	0
B.BIAS	9	8	0	255	0
R.DRIVE	10	7	127	127	0
Drive.Test	11	1	0	1	0
B Gamma.Sel	11	2	0	3	0
RG.Gamma.Def	11	1	1	1	0
G.DRIVE	11	4	8	15	0
B.DRIVE	12	7	127	127	0
Blank.Def	13	1	0	1	0
Sub.Bright	13	7	64	127	0
Bright	14	7	64	127	0
Contrast	15	7	64	127	0
OSD Cnt.Test	16	1	0	1	0
OSD Contrast	16	7	64	127	0
Blk.Str.Deff	17	1	1	1	0
Coring	17	1	1	1	0
Sharpness	17	6	0	63	0
Tint.Test	18	1	0	1	0
Tint	18	7	64	127	0
Color.Test	19	1	0	1	0
Color	19	7	64	127	0
Video.SW	20	1	0	1	0
Trap.Test	20	3	4	7	0
Filter.Sys	20	4	2	15	0
(AKB B/W)	21	1	0	1	0
(AKB Def)	21	1	0	1	0
C.Temp.R	21	6	32	63	0
FBPBLK.SW	22	1	1	1	0
C.Temp.G	22	6	32	63	0
(AKB Test)	23	2	0	3	0
C.Temp.B	23	6	32	63	0

Continued on next page.

LA76810A

Continued from preceding page.

Register	TR	BIT	INITIAL	MAX	MIN
Auto.Flesh	24	1	0	1	0
C.Ext	24	1	0	1	0
C.Bypass	24	1	1	1	0
C_Kill ON	24	1	0	1	0
C_Kill OFF	24	1	0	1	0
Color.Sys	24	3	0	7	0
Cont.Test	25	1	0	1	0
Bright.Abl.Threshold	25	3	4	7	0
Emg.Abl.Def	25	1	0	1	0
Brt.Abl.Def	25	1	0	1	0
Mid.Stp.Def	25	1	0	1	0
R-Y/B-Y Gain Balance	26	4	8	15	0
R-Y/B-Y Angle	26	4	8	15	0
SECAM B-Y DC Level	27	4	8	15	0
SECAM R-Y DC Level	27	4	8	15	0
Audio.SW	28	1	0	1	0
Volume	28	7	0	127	0
FM.TEST	29	1	0	1	0
VOL.FIL	29	1	0	1	0
RF.AGC	29	6	32	63	0
FM.Mute	30	1	0	1	0
deem.TC	30	1	0	1	0
VIF.Sys.SW	30	2	1	3	0
SIF.Sys.SW	30	2	1	3	0
FM.Gain	30	1	0	1	0
IF.AGC	30	1	0	1	0
VIDEO.LEVEL	31	3	4	7	0
FM.LEVEL	31	5	16	31	0

Status Byte Truth Table

Status Byte Truth Table		
Register	0 HEX	1 HEX
POR	Undetected	Detected
IF.IDENT	Sync Undetected	Sync Detected
RF.AGC	RF.AGC.OUT = "L"	RF.AGC.OUT = "H"
IF.LOCK	Lock	Unlock
V.TRI	V.Triger Undetected	V.Triger Detected
50/60	50	60
ST/NONST	Non-Standard	Standard
H.LOCK	Horiz Unlocked	Horiz Locked
(AKB R)	R Beam Current Low	R Beam Current High
(AKB G)	G Beam Current Low	G Beam Current High
(AKB B)	B Beam Current Low	B Beam Current High

Color System	0 HEX	B/W
	1 HEX	PAL
	2 HEX	PAL-M
	3 HEX	PAL-N
	4 HEX	NTSC
	5 HEX	4.43NTSC
	6 HEX	SECAM
	7 HEX	Do not care

www.DataSheet4U.com

- Specifications of any and all SANYO Semiconductor products described or contained herein stipulate the performance, characteristics, and functions of the described products in the independent state, and are not guarantees of the performance, characteristics, and functions of the described products as mounted in the customer's products or equipment. To verify symptoms and states that cannot be evaluated in an independent device, the customer should always evaluate and test devices mounted in the customer's products or equipment.
- SANYO Semiconductor Co., Ltd. strives to supply high-quality high-reliability products. However, any and all semiconductor products fail with some probability. It is possible that these probabilistic failures could give rise to accidents or events that could endanger human lives, that could give rise to smoke or fire, or that could cause damage to other property. When designing equipment, adopt safety measures so that these kinds of accidents or events cannot occur. Such measures include but are not limited to protective circuits and error prevention circuits for safe design, redundant design, and structural design.
- In the event that any or all SANYO Semiconductor products (including technical data, services) described or contained herein are controlled under any of applicable local export control laws and regulations, such products must not be exported without obtaining the export license from the authorities concerned in accordance with the above law.
- No part of this publication may be reproduced or transmitted in any form or by any means, electronic or mechanical, including photocopying and recording, or any information storage or retrieval system, of otherwise, without the prior written permission of SANYO Semiconductor Co., Ltd.
- Any and all information described or contained herein are subject to change without notice due to product/technology improvement, etc. When designing equipment, refer to the "Delivery Specification" for the SANYO Semiconductor product that you intend to use.
- Information (including circuit diagrams and circuit parameters) herein is for example only; it is not guaranteed for volume production. SANYO Semiconductor believes information herein is accurate and reliable, but no guarantees are made or implied regarding its use or any infringements of intellectual property rights or other rights of third parties.

This catalog provides information as of November, 2006. Specifications and information herein are subject to change without notice.