

HA12411 / HA12418

FM IF System

HITACHI HA12411* and HA12418* have been developed for the use of FM car radio. HA12411 is encapsulated in a DIP-16pin, and HA12418 in a SIP-16pin (Vertical Plastic Package). These IC's employ the same chips, and their functions and features are as follows.

FUNCTIONS

- FM IF Amplifier
- Quadrature Detector
- Audio Post-Amplifier
- Muting Circuit
- AFC, Center Meter Driver
- Muting Control Driver
- Analog Control Driver

FEATURES

- Wide range of the operating supply Voltage
- Low distortion: T.H.D. = 0.06% typ.
- High Signal-to-Noise Ratio: S/N = 75dB typ.
- High Input Sensitivity: $V_{in} (lim) = 31dB\mu$ typ.
- Capable of driving the signal meter under low input signal
- High stability against abnormal oscillation

*Note) HA12411 and HA12418 have the pin-to-pin compatibility with HA1137W.

HA12411



(DP-16)

HA12418



(SP-16)

BLOCK DIAGRAM

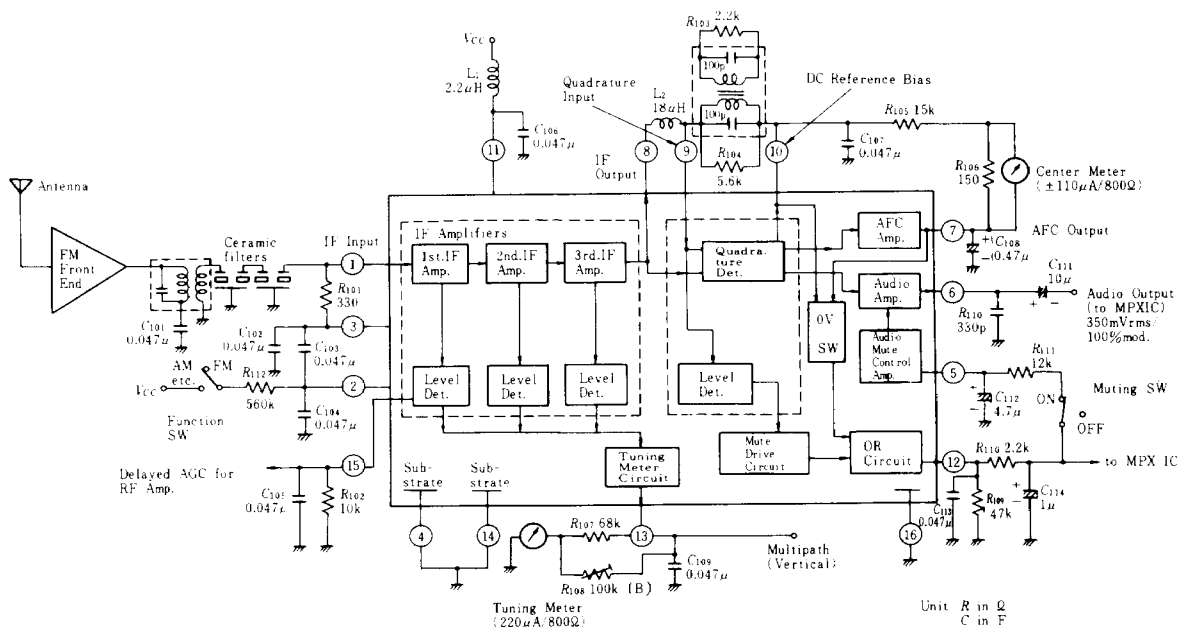

■ ABSOLUTE MAXIMUM RATINGS

Item	Symbol	Rating	Unit
Supply Voltage	V_{CC}	16	V
Power Dissipation	P_T	624*	W
Operating Temperature	T_{opr}	-20 to +70	°C
Storage Temperature	T_{stg}	-55 to +125	°C

* at $T_a=60^\circ\text{C}$

DELATING CURVE

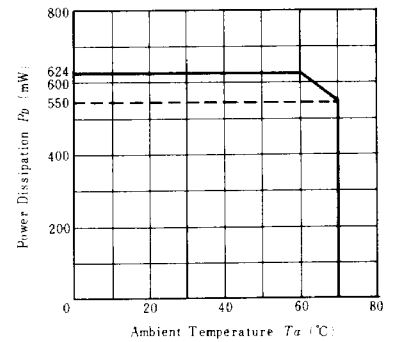

■ ELECTRICAL CHARACTERISTICS

● DC CHARACTERISTICS ($T_a=25^\circ\text{C}$, $V_{CC}=8\text{V}$, $V_{in}=0\text{dB}\mu$)

Item	Symbol	min.	typ.	max.	Unit
DC Voltage at Pin 1	V1	—	1.95	—	V
DC Voltage at Pin 2	V2	—	1.95	—	V
DC Voltage at Pin 3	V3	—	1.95	—	V
DC Voltage at Pin 6	V6	—	5.60	—	V
DC Voltage at Pin 7	V7	—	5.60	—	V
DC Voltage at Pin 10	V10	—	5.60	—	V

● AC CHARACTERISTICS ($T_a=25^\circ\text{C}$, $V_{CC}=8\text{V}$, $f_c=10.7\text{MHz}$, $f_m=1\text{kHz}$, $\Delta f=75\text{kHz dev.}$)

Item	Symbol	Test Conditions	min.	typ.	max.	Unit
Operating Current	I_{CC}	$V_{in}=100\text{dB}\mu$, Mute ON	—	32	39	mA
Limiting Sensitivity	$V_{in}(\text{lim})$	at -3dB	—	31	37	$\text{dB}\mu$
Recovered Output	$V_o(\text{AF})$	$V_{in}=100\text{dB}\mu$	230	300	390	mVrms
Total Harmonic Distortion	$T.H.D$	$V_{in}=100\text{dB}\mu$	—	0.06	0.3	%
Signal-to-Noise Ratio	S/N	$V_{in}=100\text{dB}\mu$	67	75	—	dB
AM Rejection	AMR	$V_{in}=100\text{dB}\mu$, $f_m(\text{AM})=1\text{kHz}$, 30% mod.	45	55	—	dB
Muting Attenuation	Mute(ATT)	$V_{in}=100\text{dB}\mu$, $V_s=2\text{V}$	68	75	—	dB
Muting Band Width	$BW(\text{Mute})$	Detuned frequency under 1.4V of Pin=12 voltage, $V_{in}=100\text{dB}\mu$	—	100	—	kHz
Muting Sensitivity	$V_{in}(\text{Mute})$	V_{in} under 1.4V of Pin-12 voltage	—	35	—	$\text{dB}\mu$
Analogue Control Voltage	V_{13-0}	Pin-13 voltage under $V_{in}=0\text{dB}\mu$	—	0.2	—	V
	V_{13-60}	Pin-13 voltage under $V_{in}=60\text{dB}\mu$	—	1.65	—	V
	V_{13-100}	Pin-13 voltage under $V_{in}=100\text{dB}\mu$	—	4.7	—	V
AGC Control Voltage	V_{15}	Pin-15 voltage under $V_{in}=86\text{dB}\mu$	—	3.7	—	V

V₁₂, V₁₃, V₁₅, VS. V_{in}

T.H.D, NOISE, V_{out}, I_{CC}, AMR VS. V_{in}

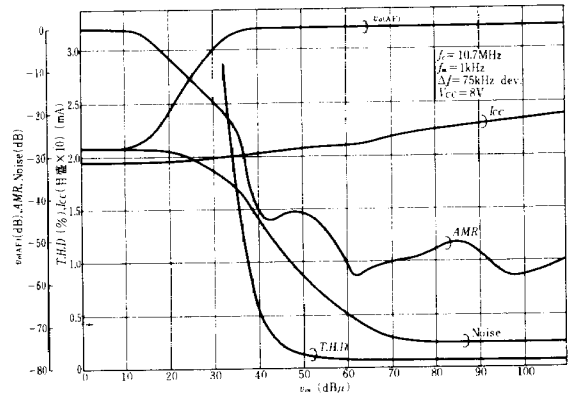
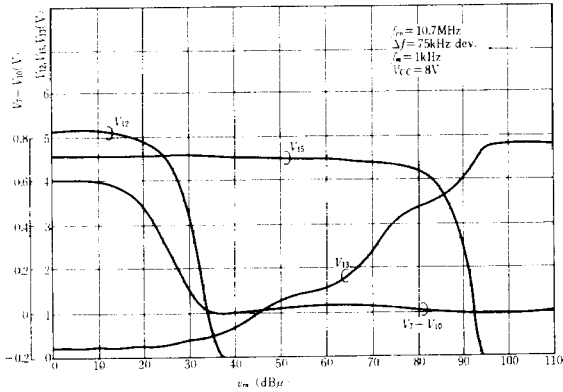

V₁₂ VS. DETUNED FREQUENCY

Mute(ATT), T.H.D VS. V_s VOLTAGE

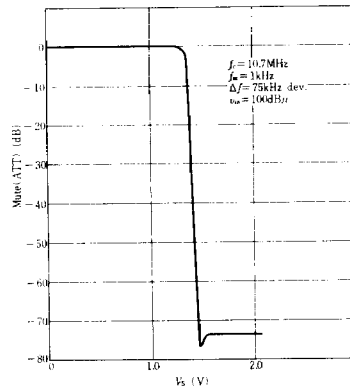
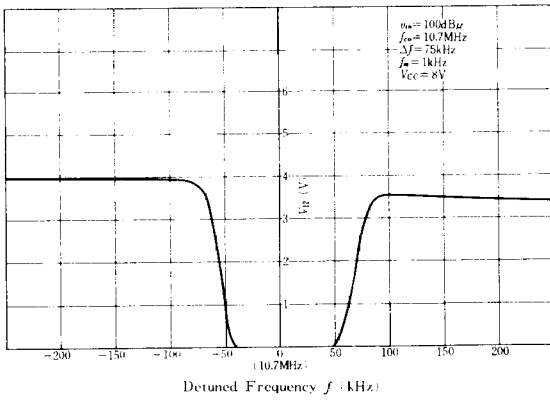

S/N, V_o(AF), AMR, T.H.D, V_{in}(lim), V_{in}(Mute) VS. V_{CC}

(V₇-V₁₀), V₁₂₋₁₀₀, V₁₂₋₀, V₁₅₋₈₀, V₁₃₋₇₀, V₁₃₋₅₄, V₁₃₋₀ VS. V_{CC}

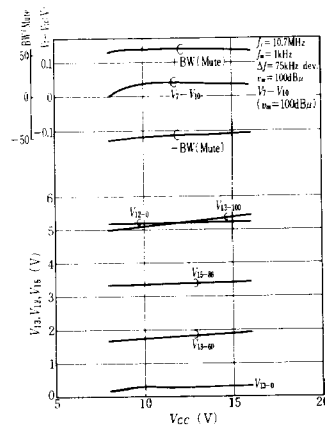
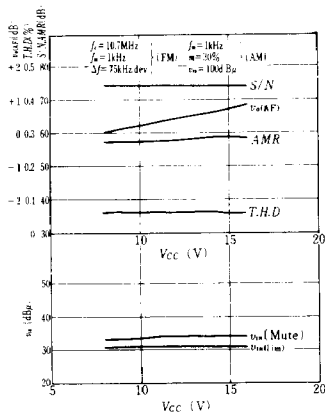

Mute(ATT), S/N, V_o (AF), AMR VS. AMBIENT TEMPERATURE

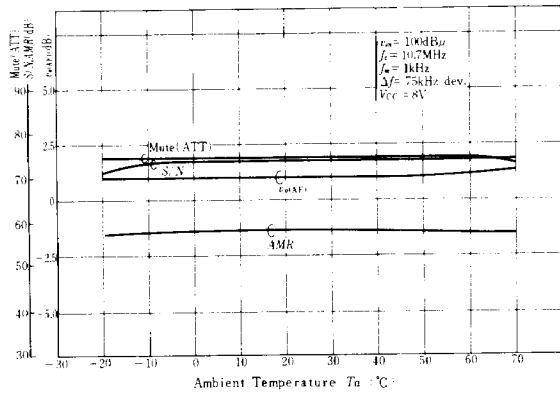

V_{in} (Mute), V_{in} (lim) VS. AMBIENT TEMPERATURE

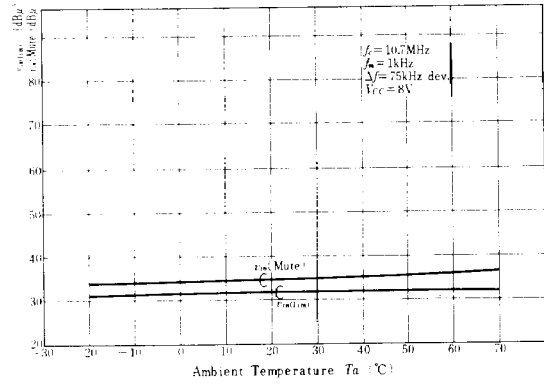

T.H.D, BW(Mute) VS. AMBIENT TEMPERATURE

