

TENTATIVE TOSHIBA Bi-CMOS INTEGRATED CIRCUIT, SILICON MONOLITHIC

TB1254N

PAL / NTSC / SECAM 1CHIP (IF+VCD PROCESSOR) IC

The TB1254N is a TV signal processor IC, which contains PIF, SIF, Video, Chroma and deflection signal processors for worldwide Multi-color systems. Also, it has AV switch for TV/EXT inputs.

The line-up and flexibility of this TB1251 series contributes to reduce development costs and components in a TV sets.

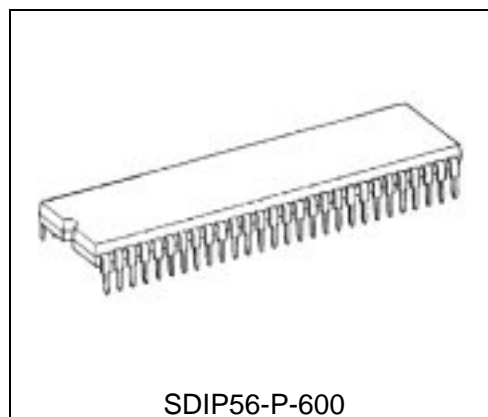

SDIP56-P-600

Weight: 5.55g (typ)

FEATURES

IF STAGE

- Multi-system IF
- SIF 4.5 ~ 6.5 MHz
- One External BPF for Multi-SIF carrier
- Inter carrier inputs
- VCO tank coil alignment free
- for L system,
Positive demodulation
V low Ch

VIDEO STAGE

- Built-in Y delay line (8 adjustable steps)
- Built in C trap filter (Switchable)

CHROMA STAGE

- Multi-color Demoduration
- Automatic Chroma Identification
- 1 Xtal for Multi-color Systems
(3.58MHz/4.43MHz/M-PAL/N-PAL)
- Built-in 1H Delay line
- Cb/Cr input ports
- Built-in BPF / TOF
- Fsc Output
- Two NTSC demodulation phase

TEXT STAGE

- Built-in AKB
AKB on/off
AKB Color temperature control
- Analog RGB interfaces
- ABL / ACL

DEFLECTION STAGE

- Built-in H-VCO
- ramp distortion correction
- Stand Along Sync in port
- Sand Castle Pulse Output
(HD+VD+Gate Pulse)

AV SWITCH

- Visual TV / EXT inputs
- Audio TV / EXT inputs

● TOSHIBA is continually working to improve the quality and the reliability of its products. Nevertheless, semiconductor devices in general can malfunction or fail due to their inherent electrical sensitivity and vulnerability to physical stress. It is the responsibility of the buyer, when utilizing TOSHIBA products, to observe standards of safety, and to avoid situations in which a malfunction or failure of a TOSHIBA product could cause loss of human life, bodily injury or damage to property. In developing your designs, please ensure that TOSHIBA products are used within specified operating range as set forth in the most recent products specifications. Also, please keep in mind the precautions and conditions set forth in the TOSHIBA Semiconductor Reliability Handbook.

● The products described in this document are subject to foreign exchange and foreign trade control laws.

● The information contained herein is presented only as a guide for the applications of our products. No responsibility is assumed by TOSHIBA CORPORATION for any infringements of intellectual property or other rights of

TB1254N BLOCK DIAGRAM

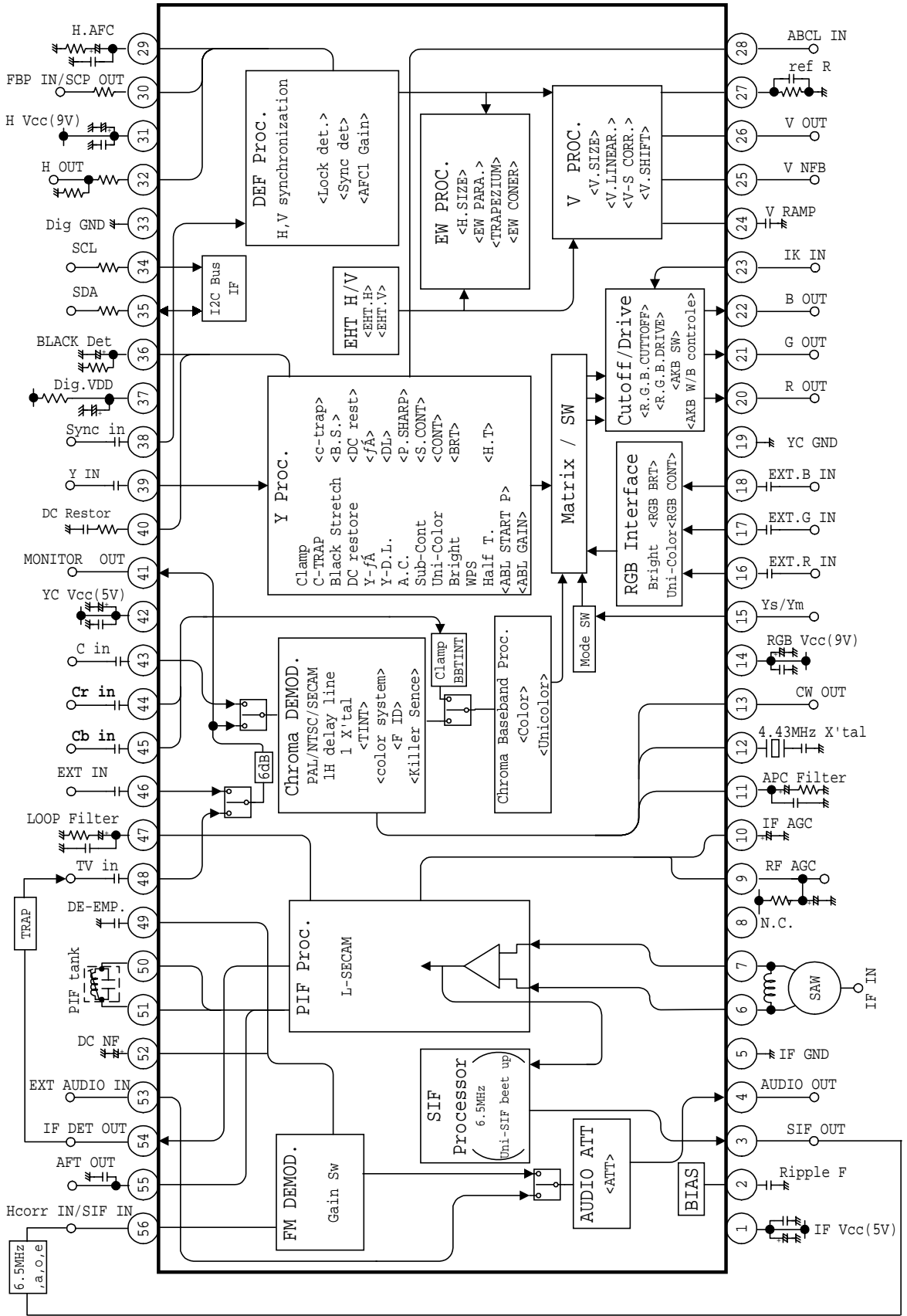

TERMINAL INTERFACE

	PIN NAME	FUNCTION	INTERFACE
1	IF VCC	A Vcc terminal for the IF circuit. Supply 5V.	•
2	RIPPLE FILTER	A terminal to be leaded to an internal bias filter. Put a capacitor.	
3	SIF OUT	An output terminal for a 1st SIF signal, that beaten down by a regenerated carrier. The SIF frequencies are able to convert into only 6.5MHz, in order to eliminate SIF BPFs to single 6.5MHz.	
4	AUDIO OUT	An output terminal for audio signal. FM Det.signal or the external audio signal, input to pin53, is output (Switched by bus). An internal audio attenuator controls the output levels. •	
5	IF GND	The GND terminal for IF circuit.	•
6 7	IF IN IF IN	Input terminals for IF signals. Pin 6 and 7 are the both input poles of a differential amplifier. The nominal input level is 90dB(•V)(Pin6-7), input impedance is 1.5 k ohms.	
8	NC		-

	PIN NAME	FUNCTION	INTERFACE
9	RF AGC	<p>An output terminal for RF AGC.</p> <p>A pull up resistor is required because of its open collector output, and also connect de-coupling capacitor to reduce noises,.</p>	
10	IF AGC	<p>A terminal to be connected to an IF AGC filter. Connect 2.2μF of capacitor to Vcc</p>	
11	APC FILTER	<p>A terminal to be connected with an APC filter for chroma demodulation.</p> <p>This terminal voltage controls the frequency of VCXO.</p>	
12	X'TAL (4.43MHZ)	<p>A terminal to be connected with a 4.433619MHz X'tal oscillator. The oscillated signal lead to chroma demodulation, H out frequency tuning, AFT and so on.</p>	
13	CW OUT	<p>An output terminal for the continuous chroma sub-carrier frequency wave, which amplitude is 0.7Vp-p (typ).</p> <p>Also the dc level shows killer status, the level is 1.5V for B/W and 3.5V for Color.</p>	

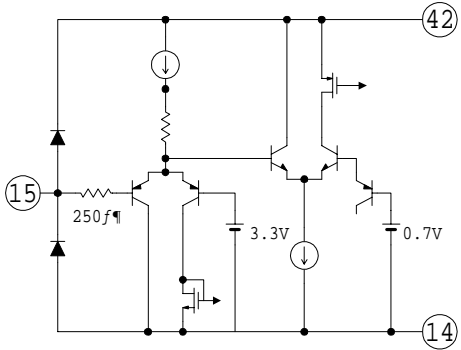
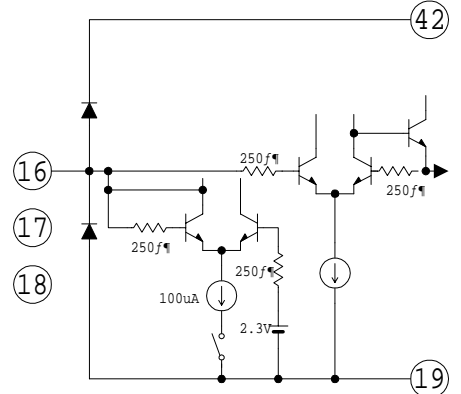
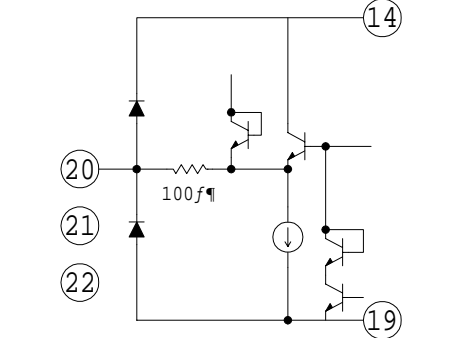
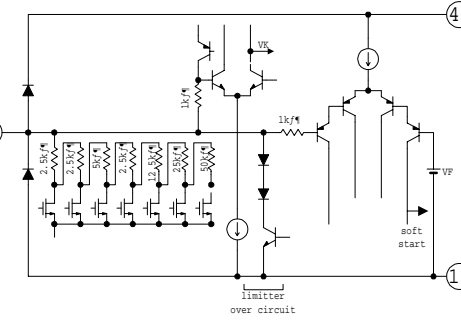
	PIN NAME	FUNCTION	INTERFACE
14	RGB VCC (9V)	A Vcc terminal for RGB block, PIF det. Output and sound output circuit. Supply 9V.	.
15	YS/YM SW •Spot killer	A terminal for switching of EXT RGB Mode and fast Half tone.	
16 17 18	EXT. R IN EXT. G IN EXT. B IN	Input terminals for EXT RGB signals. The signals are clamped by capacitors, therefore the input impedance should be low, 100 ohms or less is recommended. For this input, brightness and RGB contrast are available, also ABL/ACL eliminate the output level. This ABL/ACL is able to off. OFF: for small area like OSD ON: for large area like TELETEXT (input level 0.7Vp-p/100IRE)	
19	Y/C GND	The GND terminal for Y/C circuit.	.
20 21 22	R OUT G OUT B OUT	Terminals for R/G/B signal output. Connect resistances to GND, if through rate is not enough. Because of source current limitation, the resistances should be 2.0k• or more.	
23	IK IN	An input terminal to sense AKB cathode current. Connect this terminals to GND if not using the AKB system.	

PIN NAME	FUNCTION	INTERFACE
24 V RAMP	<p>A terminal to be connected with a capacitor to generate the V.Ramp signal. The V.Ramp amplitude is kept constant by the V.AGC.</p>	
25 V NFB	<p>An input terminal for V saw-teeth signal feedback. If the DC voltage on this pin is less than 1.7V, it blanks RGB output for V guard.</p>	
26 V OUT	<p>An output terminal for the vertical driving pulses.</p>	
27 REF. R	<p>A terminal to be connected with resistance to stabilize internal current sources. Connect $5.6\text{ k}\Omega \pm 1\%$ of resistance to GND.</p>	

PIN NAME	FUNCTION	INTERFACE
28 ABCL IN	An input terminal for ABL/ACL control. Control voltage range is 5.5•6.0V. The ratio of ABL against ACL can be set by bus control.	
29 H AFC FILTER	A terminal to be connected with H. AFC Filter. The DC voltage of this pin controls the H VCO frequency.	
30 FBP IN/ SCP OUT	An input terminal for FBP. The V and GP Pulses are overlaid as SCP.	
31 H VCC (9V)	A Vcc terminal for DEF circuit, HOUT, IICBUS POR etc. Supply 9V.	.
32 H OUT	An output terminal for horizontal driving pulses.	
33 DIG GND	A GND terminal for digital block.	.

PIN NAME	FUNCTION	INTERFACE
34 SCL	An input terminal for IICBUS clock.	
35 SDA	An input/output terminal for IICBUS data.	
36 BLACK DET	<p>A terminal to be connected with Black det. filter for black stretch.</p> <p>This terminal voltage controls Black stretching gain.</p> <p>The IIC Bus controls on/off and start point of Black stretch.</p>	
37 DIG. VDD	<p>A Vdd terminal for of digital block.</p> <p>Supply HVcc voltage through 270 ohms of resistance.</p> <p>The voltage of this terminal is clipped in about 3.3V by the internal regulator.</p>	

PIN NAME	FUNCTION	INTERFACE
38 SYNC IN	<p>An input terminal for Sync signal. The input sync chip is clamped by charging/discharging the coupling capacitors so as to align the Sync slice level, therefore input through low impedance buffer. (input level 1Vp-p/140IRE)</p>	
39 Y IN	<p>An input terminal for Y signal. The pedestal level is clamped by means of charging/discharging the coupling capacitor, therefore input through low impedance buffer. (1Vp-p/140IRE input level)</p>	
40 DC RESTOR	<p>A terminal to be connected with a capacitor to detect the average picture level for DC restoration. The ratio of the DC restoration is set by bus. Leave this terminal open if the DC restoration is not required.</p>	
41 MON OUT	<p>An output terminal of AV SW monitor. The input signal for pin # 46/48 is output through 6dB amplifier. (output level 2Vp-p/140IRE)</p>	
42 Y/C VCC	<p>An Vcc terminal for Y/C circuit. Supply 5V.</p>	

PIN NAME	FUNCTION	INTERFACE
43 C-IN	An input terminal for chroma signal. (standard burst amplitude level 286mVp-p. The low/High impedance status of this pin can be read by bus to detect if S port is connected or not.	
44 Cr IN 45 Cb IN	Input terminals for Cb/Cr signals. This terminal is clamped by charging / discharging the coupling capacitors, therefore input with low impedance, 100• or less are recommended. B.B.TINT •-/+12deg • Sub color control are available for Cb/Cr input signals.	
46 EXT IN	An input terminal for external video signal. (input level 1Vp-p / 140 IRE)	
47 LOOP FILTER	A terminal to be connected with loop filter for PIF PLL. The terminal voltage is controlled PIF VCO frequency.	

	PIN NAME	FUNCTION	INTERFACE
48	TV IN	An input terminal for TV video signal. (input level 1Vp-p / 140 IRE)	
49	De-Emphasis •Mon-OUT	A terminal to De-Emphasis Audio signal, and pick up detected Audio signal. Connect capacitor (0.01•F to GND. The time constant 50/75us is set by the IICBUS control "SIF Freq". Remove the capacitor in case of use US/JPN sound multiplex system.	
50 51	PIF TANK	Terminals to connect a PIF tank coil. The tank coil should be pre-set up within +/- 2% for the automatic tuning. Manual tuning is also available.. The resonance capacitance of the tank should be 18pF.	
52	DC NF	A terminal for connect the capacitor for DC NF.	

	PIN NAME	FUNCTION	INTERFACE
53	EXT AUDIO IN	An input terminal for external audio signal. Nominal input level is 500mVrms.	
54	IF DET OUT	An output terminal of detected PIF. (typical output level 2.2Vp-p)	
55	AFT OUT	An output terminal for AFT. output dc range; 0.2.5.5V. output impedance; 50 k ohms (typ.)	
56	SIF in / H corr.	An input terminal for 2'nd SIF signal and H.curve correction.	

BUS CONTROL MAP for TB1254N

Write Mode

Slave Address: 88 HEX

Sub Addr.	D7 MSB	D6	D5	D4	D3	D2	D1	D0 LSB	PRESET
00	WPS	Uni-Color							0000 0000
01	B.B.	Brightness (TV / Text)							0100 0000
02	C-Trap	Color							0100 0000
03	N Phase		Sharpness						0010 0000
04	Y MUTE	RGB Mt	RGB Contrast						0110 0000
05	Y D.L.			Sub Color					0011 0000
06	Video SW		Au SW	B.B.Tint					0001 0000
07	N-Comb	TINT							0100 0000
08	SECAM R-Y Black Adjust				SECAM B-Y Black Adjust				1000 1000
09	S- GP Phase / S- inhibit		S-ID Sens	Bell fo	S-Black Monitor	L-SECAM Mode	L-S AGC Speed-up	S-ID Mode	0000 0000
0A	PIF Freq			SIF Freq.		Color System			0000 0000
0B	6.5MHz SIF Fix	Audio Att							0000 0000
0C	BPF/TOF	P/N-ID Sens	F ID	Coring off	SIF 5.74MHz	PIF VCO Adj. Stop	PIF VCO Adj. Req	PIF VCO Center	0000 0000
0D	Sprit•nt•	Over Mod SW	Q Det Gain	AFT Sens	Au Gain	AFT Mute	STD by Mode		0000 0000
0E	Self Test		RF AGC						0000 0000
0F	Ysm M	RGB ABCL	DC Restoration		Black Stretch		γ Point		0000 0000
10	ABL Start Point		ABL Gain		Sub Contrast			0000 1000	
11	AKB System					Buzz reducer	color - γ		0001 1000
12	R Cut Off								0000 0000
13	G Cut Off								0000 0000
14	B Cut Off								0000 0000
15	Cb/Cr SW	G Drive Gain						0100 0000	
16	BLK	B Drive Gain						0100 0000	
17	H-Stop	V-Stop	V AGC	V Ramp Ref.	V-Freq.		312/313 Mode		0000 0000
18	Vertical Position			Horizontal Position					0001 0000
19	V Linaerity				V S Correction				1000 1000
1A	AFC G		Vertical Size						0010 0000
1B	test(0)	test(0)							0010 0000
1C	*	*							0010 0000
1D									1000 0100
1E									0100 0100
1F	Test Mode								0000 0000

READ Mode

	7	6	5	4	3	2	1	0
R0	POR	IF Lock	H Lock	IF Level	V Freq	Color System		
R1	Y-IN	RGB OUT	H-OUT	V-OUT	PIF VCO Adj.	V Lock	AFT	
R2		Coil error	PIF- VCO error det	SYNC DET	C IN DC	Product Code		
R3	AKB Overflow	CRT Warm up	AKB finish	STD/Non-STD	P ID	N-ID	S ID	noise det

IIC BUS CONTROL FUNCTION

WRITE MODE

PIF STAGE

ITEMS	BITS	DESCRIPTIONS	PRESET
RF AGC ••Sub; 0E h	6	RF AGC delay point (Pin6-7) 01: 65 dB(•V) 3F: 100 dB(•V) 00: IF MUTE Stops Demodulation	00000 :Mute
IF Freq. ••Sub; 0A h	3	Setting IF frequency for digital AFT count down 000: 58.75 MHz 001: 45.75 MHz 010: 39.5 MHz 011: 38.9 MHz 100: 38.0 MHz 101: 34.47 MHz 110: 33.95 MHz 111: 34.2 MHz	000 :58.75MHz
AFT Mute ••Sub; 0D h	1	AFT Mute Switch 0: normal 1: AFT defeat (mute)	0:normal
AFT sens. ••Sub; 0D h	1	AFT sensitivity 0: 100kHz/v 1: 25kHz/V	0:100kHz
Over mod SW ••Sub; 0D h	1	on/off the over modulation switch 0: off 1: on	0:off
Q det. Gain ••Sub; 0D h		Q detector gain 0: high 1: low	0:high
L-SECAM Mode ••Sub; 09 h	1	L SECAM 0: Not L-SECAM 1: L-SECAM turn the polarity for TV Det Out •for positive modulation• Delay the AGC time constant (Peek AGC) SIF AM demodulation	0:Not L-SECAM
L-SECAM AGC Speed ••Sub; 09 h	1	Speed up the AGC sense for channel serch 0: normal 1: speed-up •Ch Serch•	0:normal
VCO Center ••Sub; 0C h	1	VCO center SW 0: normal 1: Center In adjusting a tank coil, set this bit to 1.	0: normal
VCO Adj. Request ••Sub; 0C h	1	VCO adjust trigger 0: normal 1: VCO adjust trigger The PIF VCO starts adjusting after requested. While adjusting, the picture is blanked	0: normal
VCO Adj. Stop ••Sub; 0C h	1	Stop the readjustment on detecting the loosing adjustment 0: normal 1: stop self adjustment "VCO Adj request" prior it	0: normal

SIF STAGE

ITEMS	BITS	DESCRIPTIONS	PRESET
SIF Freq. ••Sub; 0A h	2	SIF Frequency 00: 5.5MHz 01: 6.0MHz 10: 6.5MHz 11: 4.5MHz Set the SIF frequency for; Select the SIF FM demodulator band select the de-emphasis speed Set the ref.freq. for single •••MHz beet up if using	00:5.5MHz
SIF 574 ••Sub; 0C h	1	Set the SIF freq. to 5.74MHz for IGR Bilingual. It sets the reference freq. for beet up the 5.74MHz to 6.5MHz. 0: other frequencies 1: 5.74MHz	0:other frequencies

ITEMS	BITS	DESCRIPTIONS	PRESET
Audio ATT ••Sub; 0B h	7	Audio attenuator 00: Mute 01: -85 dB ~ 7F: 0 dB	00: Mute
Au Gain ••Sub; 0D h	1	Audio Gain Switch 0: 927mVrms at 25kHz/DEV 1: 500mVrms at 25kHz/DEV	0: 927mVrms at 25kHz/DEV
6.5MHz SIF Fix ••Sub; 0A h	1	Beet up the SIF carrier frequency to 6.5MHz (single carrier) 0: normal 1: beet up to uni- 6.5MHz	0: normal
Buzz Reducer ••Sub; 11 h	1	Nyquist Buzz Reducer SW 0: on 1: off	0: on

VIDEO STAGE

ITEMS	BITS	DESCRIPTIONS	PRESET
Sharpness ••Sub; 03 h	6	Sharpness control peak:2.75MHz 00: -5.4dB ~ 20: 3.3dB ~ 3F: 6.6 dB	00:-5.4dB
DC Rest. ••Sub; 0F h	2	DC Restoration control 00: 120% 01: 90% 10: 100% 11: 110%	00:120%
Black Stretch ••Sub; 0F h	2	Set the black stretch start point 00: off 01: 25IRE 10: 35IRE 11: 45IRE	00: off
•point ••Sub; 0F h	2	Set the non linear γ curve for Y signal 00: off 01: 90IRE 10: 80IRE 11: 70IRE	00: off
Y DL ••Sub; 05 h	3	Y Delay time 000: -40ns 100: +120ns 001: 0ns 101: +160ns 010: +40ns 110: +200ns 011: +80ns 111: +240ns	001: 0ns
C-Trap ••Sub; 02 h	1	Chroma trap filter for Y input 0: OFF for Y / C Separated input 1: ON for internal C trap(-20dB or less)	0:OFF
WPS ••Sub; 00 h	1	White Peak Suppressor Switch 0: ON 1: OFF	0:ON
coring SW ••Sub; 0Ch	1	on/off the coring 0: on 1: off	0: on

CHROMA STAGE

ITEMS	BITS	DESCRIPTIONS	PRESET
TINT ••Sub; 07 h	7	Tint control for NTSC (CW TINT) 00: -33 deg ~ 7F: 33 deg	00:0deg
Color System ••Sub; 0A h	3	Color system switch 000: Auto 1 443PAL , 358NTSC , SECAM , 443NTSC 001: Auto 2 358NTSC , M-PAL , N-PAL (for S-America) 010: Fixed 358NTSC 011: Fixed 443NTSC 100: Fixed 443PAL 101: Fixed SECAM 110: Fixed M PAL 111: Fixed N PAL	000: Auto 1
N-Comb ••Sub; 07 h	1	Comb filter for base-band color signal of NTSC 0: ON 1: OFF	0: ON
NTSC Phase ••Sub; 03 h	2	set the relative phase / amplitude 00: NTSC1 (90 deg) 01: NTSC2 (105 deg) 10/11: DVD (90 deg, 245 deg) for U/V inputs	00:NTSC1 (90 deg)
BPF/TOF ••Sub; 0C h	1	Select chroma BPF frequency response 0: BPF for EXT input 1: TOF for RF input	0:BPF
P/N ID Sens ••Sub; 0C h.	1	PAL / NTSC ID sensitivity for digital comb filter 0: Normal 1: Low	0:Normal
F ID ••Sub; 0E h	1	Forced killer off 0: normal 1: always color on in a fixed color systems (This function dose not work in Auto 1 and Auto 2 mode)	0:normal

SECAM STAGE

ITEMS	BITS	DESCRIPTIONS	PRESET
SECAM GP Phase / SECAM inhibit	2	SECAM ID phase / SECAM inhibit 00: +200ns 01: normal 10: -200ns 11: SECAM inhibit	00:+200ns
S Black Adj. R-Y ••Sub; 08 h	4	SECAM Black level adjust 0: -92 mV ~ F: +85mV 14mV/dev	1000: 0 mV
S Black Adj. B-Y ••Sub; 08 h	4	SECAM Black level adjust 0: -92 mV ~ F: +85mV 14mV/dev	1000: 0mV
Bell fo ••Sub; 09 h	1	SECAM Bell filter fo shift 0: 0 kHz 1: +35 kHz	0:0 kHz
S ID sense ••Sub; 09 h	1	SECAM ID Sensitivity 0: normal 1: Low	0:normal
S ID mode ••Sub; 09 h	1	SECAM ID mode 0: H 1: H+V	0:H
S Black monitor ••Sub; 09 h	1	SECAM Black level alignment mode 0: normal 1: Alignment	0:normal

TEXT STAGE

ITEMS	BITS	DESCRIPTIONS	PRESET
Uni-Color ••Sub; 00 h	7	Uni-Color control 00: -12 dB ~ 7F: 12dB	0000000 :0dB
Brightness ••Sub; 01 h	7	Brightness control 00: 1.75 V ~ 7F: 3.25 V (Pedestal Level)	1000000 :2.50V
Color ••Sub; 02 h	7	Color control 00: -20 dB or less ~ 7F: 6.5 dB	1000000 :0dB

ITEMS	BITS	DESCRIPTIONS	PRESET
RGB Contrast ••Sub; 04 h	6	Contrast control for RGB input 00: -8.0 dB ~ 3F: 11.4 dB 0.2Vinput	100000 :6.2dB
Cb/Cr SW ••Sub; 05 h	1	Cb/Cr Switch 0: Cb/Cr internal 1: Cb/Cr external	0: Cb/Cr internal
Sub-color ••Sub; 05 h	5	Sub color control (for Cb/Cr input) 00: -3 dB or less ~ 7F: +3 dB	100000 :0dB
B.B Tint ••Sub; 06 h	5	Base band tint control (for Cb/Cr input) 00: -12deg 1F: +12deg	10000 :0deg
Sub-Contrast ••Sub; 10 h	4	Sub contrast control 0: -3 dB ~ F: 2.5 dB	1000 :0dB
ABL Start Point ••Sub; 10 h	2	Selecting ABL start point 00: 0V 01: -0.20V 10: -0.30 V 11: -0.50 V	00:0V
ABL Gain ••Sub; 10 h	2	ABL Gain control 00: -0.21 V 01: -0.38 V 10: -0.50 V 11: -0.67 V	00:-0.21V
B. B. ••Sub; 06 h	1	Blue Back Switch 0: OFF 1: ON (50 IRE)	0: FF
Color • ••Sub; 11 h	1	on/off the color • 0: OFF 1: ON	0:OFF
RGB - Cutoff ••Sub; 12~14 h	8	R,G,B Cutoff control 00: -0.65 V ~ FF: 0.65 V	00:-0.65 V
G/B Drive ••Sub; 15~16 h	7	G,B Drive control 00: -5.5 dB ~ 7F: 3.5 dB	0000000 :0dB
BLK ••Sub; 16 h	1	Hor. And Vert. blanking for RGB outputs 0: Blanking ON (Normal mode) 1: Blanking OFF	0 :Blanking ON
AKB System ••Sub; 11 h	6	00: AKB off(bus control) 10: ACB cutoff -> align to targets drive -> BUS control 11: AKB cut off , drive -> align to targets	11:AKB cut off , drive
Y-Mute ••Sub; 04 h	1	on / off the Y MUTE 0: off 1: on	0:off
RGB-Mute ••Sub; 04 h	1	on / off the RGB mute 0: off 1: on	1:on
Ysm Mode ••Sub; 0F h	1	Select the Ys mode 0: Half tone mode (TV / HT / Ext RGB) 1: Blank (TV / Ext RGB / Blank)	0:Half tone mode
RGB ABCL ••Sub; 0F h	1	on / off the ABL / ACL for Ext. RGB 0: on 1: off	0: on

DEF STAGE

ITEMS	BITS	DESCRIPTIONS	PRESET
Vertical Position ••Sub; 18 h	3	Vertical Position control by delaying the V-ramp timing 0: 0H ~ 7: 7H	0:0H
Horizontal Position ••Sub; 18 h	5	Horizontal Position control 00: -3ms ~ 1F: 3ms	10000:0ms
V-Freq ••Sub; 17 h	3	Vertical frequency pull-in mode selection 000: AUTO 001: 50 Hz 010: 60 Hz 011: Forced 50Hz on no input 100:: Forced 312.5 H Stops V-synchronization 101: Forced 262.5 H Stops V-synchronization 110: Forced 313 H Stops V-synchronization 111: Forced 263 H Stops V-synchronization	000:AUTO

ITEMS	BITS	DESCRIPTIONS	PRESET
AFC Gain ••Sub; 1A h	2	Select AFC gain 00: Normal 01: 1 / 3 sensitivity 10: X 3 at V blanking duration 11: AFC OFF	00:Normal
V-stop ••Sub; 17 h	1	0: off 1: on	0:off
H STP ••Sub; 17 h	1	H OUT stop 0: normal 1 & Y-mute & RGB mute; H STOP	0:normal
312/313 Mode ••Sub; 17 h	1	Synchronize the V freq. to 312/313 0: normal 1: TELETXT(312/313) Forced sync	0:normal
V-AGC ••Sub; 17 h	1	V AGC sensitivity 0: normal 1: X 5	0:normal
Vertical Size ••Sub; 1A h	6	Vertical size alignment 00: -40 % ~ 3F: 40 %	100000:0%
V Linearity ••Sub; 19 h	4	V linearity alignment 0: 16 % at upper side , -20 % at lower side ~ F: -14 % at upper side , 17.5 % at lower side	1000:0%
V-S Correction ••Sub; 19 h	4	V-S correction 0: 12 % at upper side , 15 % at lower side ~ F: -12 % at upper side , -15 % at lower side	1000:0%
V Ramp Ref. ••Sub; 17 h	1	Select the reference voltage 0: External(YC Vcc) 1: Internal	0:External

AV SW, OTHERS

ITEMS	BITS	DESCRIPTIONS	PRESET
Video SW ••Sub; 06 h	2	Video input selecting switch 00: TV (10: TV + C in) 01: EXT (11: EXT + C in)	00:TV
Au SW ••Sub; 06 h	1	Audio input selecting Switch 0: TV 1: EXT	0:TV
STD by Mode ••Sub; 0D h	2	Stand by mode 00,01: normal 10 : IF (Working IF Block ,IICBUS and 443VCXO) 11 : STD-by (Working IICBUS and 443VCXO)	00,normal
Self Test ••Sub; 0E h	2	Selecting out put on AFT terminal for self Adjustment 00: AFT (Normal) 10: RF AGC X 1/2	00:AFT (Normal)
TEST ••Sub; 1F h	8	For testing / Leave these bits preset data ; 0000 0000	00000000

READ MODE

item	bits	Description	preset
POR	1	Power on reset 0: normal 1: Resister Preset	
IF Lock Det	1	IF lock detection 0: Lock out 1: Lock in	
H Lock Det	1	Horizontal lock detection 0: Lock out 1: Lock in	
IF level	1	IF AGC gain detection 0: High IF AGC gain 1: Low IF AGC gain Monitoring the IF AGC level to detect if the IF input level is weak or not. (The threshold level is around 50 ~ 60 dB μ)	
V Freq	1	Vertical Frequency 0: 50 Hz 1: 60 Hz	
Color System	3	Present color system status 000: B / W 001: 4.43 PAL 010: M-PAL 011: N-PAL 100: 358 NTSC 101: 443 NTSC 110: SECAM 111: N/A	
Y-in	1	Y in for self diagnostic 0: no signal 1: detected	
RGB OUT	1	RGB OUT for self diagnostic 0: no signal 1: detected	
H OUT	1	H OUT for self diagnostic 0: detected 1: no signal	
V OUT	1	V OUT for self diagnostic 0: detected 1: no signal	
PIF VCO Adj.		Turn to 1 while the PIFVCO 0: normal 1: PIF VCO adjusting	
V Lock	1	V Lock for self diagnostic 0: Lock out 1: detected	
AFT	2	AFT status 00: Lock OUT 01: too high 10: too low 11: Good	
Sync Det	1	Detecting if the H sync. pulses are or are not. 0: no signal 1: detected	
C-in DC	1	The DC voltage on C input terminal. It is for detecting the S-jack swith. 0: open 1: Low	
Product code	3	000: TB1258 001: TB1251 010: TB1252 011: TB1253 100: TB1254 101: TB1255 110: TB1256 111: TB1257	
AKB Overflow	1	0: normal 1: overflowed	
CRT Warm up	1	0: normal 1: not warm up	
AKB Finish	1	0: active 1: finished	
STD/Non -Std	1	0: non-standard V freq. 1: Standard V freq.	
P-ID	1	0: detected 1: not identified	
N-ID	1	0: detected 1: not identified	
S ID	1	0: detected 1: not identified	
Noise det	1	1: normal 0: Large noise level	
PIF VCO error detect	1	0: normal 1:error detect	
Coil error	1	0: OK 1:NG	

DATA TRANSFER FORMAT VIA I²C BUS

Start and stop condition

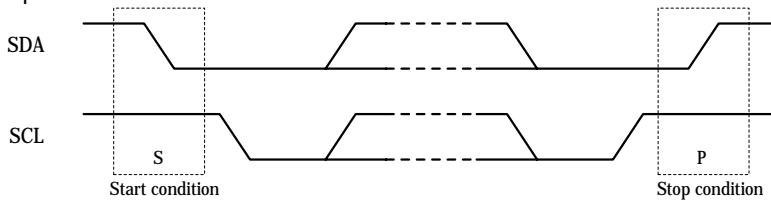

Bit transfer

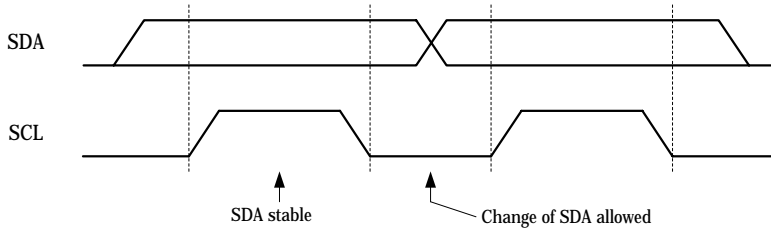

Acknowledge

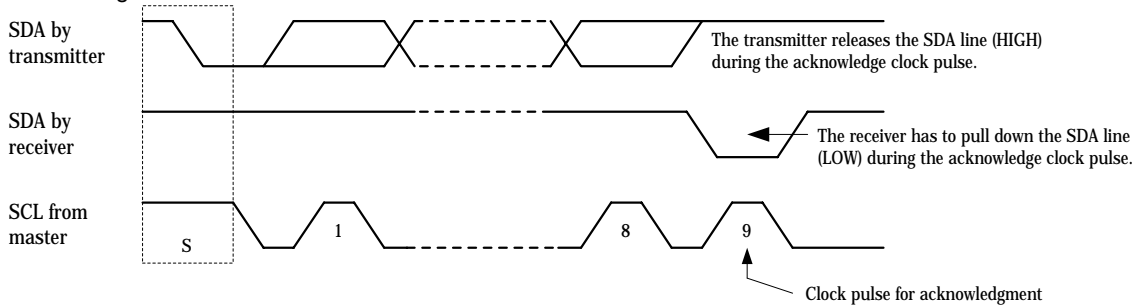

Data transmit format 1

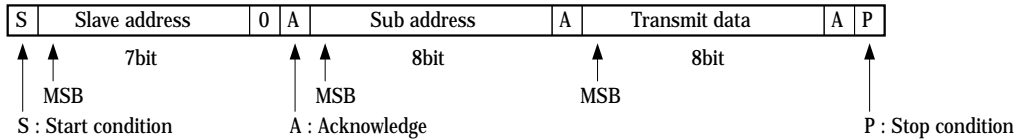

Data transmit format 2

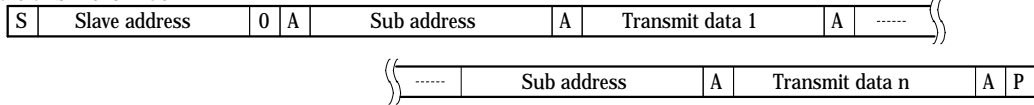

Data received format

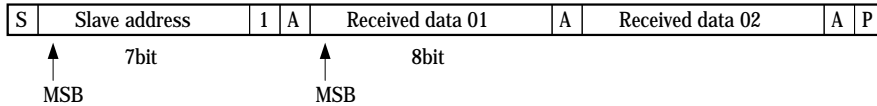

At the moment of the first acknowledge, the master transmitter becomes a master receiver and the slave receiver becomes a slave transmitter. This acknowledge is still generated by the slave. The Stop condition is generated by the master.

Optional data transmit format : automatic increment mode

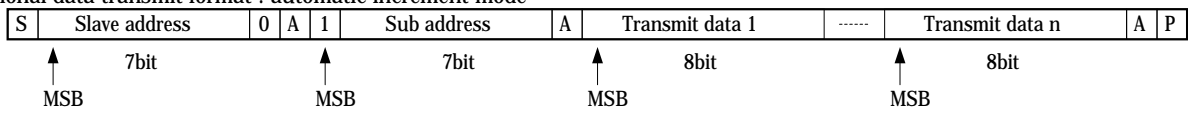

In this transmission methods, data is set on automatically incremented sub-address from the specified sub-address.

Purchase of TOSHIBA I²C components conveys a license under the Philips I²C Patent Rights to use these components in an I²C system, provided that the system conforms to the I²C Standard Specification as defined by Philips.

MAXIMUM RATINGS (Ta=25•)

ITEM	SYMBOL	RATING	UNIT
Supply Voltage (9V Vcc)	Vcc max9	12	•
Supply Voltage (5V Vcc)	Vcc max•	8	•
Power Dissipation	PD max	1980(*1)	mW
Input terminal Voltage	V in	GND - 0.3 ~ Vcc + 0.3	V
Operating Temperature	Topr	-20 ~ 65	•
Storage Temperature	Tstg	-55 ~ 150	•

(*1)When using this device at above Ta=25•, the power dissipation decreases by 15.9mW per 1• rise.

(*2) This IC is not proof enough against a strong E-M field by CRT which may cause function errors and/or poor Characteristics. Keeping the distance from CRT to the IC longer than 20 cm, or if cannot, placing shield metal over the IC, is recommended in an application.

(*3)Pin 1,4,5,6,9,11,12,13,19,26,31,32,33,34,35,37,42,43,50,51 are weak against static electricity and surge impulse. Please take counter measure to meet, if necessary.

Ta-PD Curve (on a PCB)

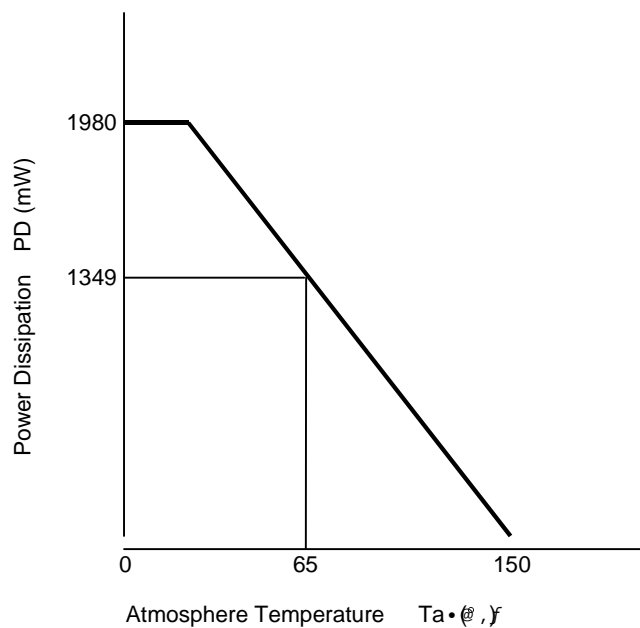

RECOMMENDED OPERATING POWER SUPPLY VOLTAGE

PIN NO.	PIN NAME	MIN.	TYP.	MAX.	UNIT	NOTE
1	IF Vcc	4.75	5	5.25	V	•
14	RGB VCC (9V)	8.55	9	9.45	V	•
31	H VCC (9V)	8.55	9	9.45	V	•
37	DIGITAL VDD	3.1	3.3	3.5	V	•
42	Y/C VCC (5V)	4.75	5	5.25	V	In the condition that IIC BUS data "V Ramp Ref." is 0:External(Y/C Vcc), the thermal drift of the Y/C Vcc should be less than 50mV.

ELECTRICAL CHARACTERISTICS

CURRENT CONSUMPTION

PIN NO.	PIN NAME	SYMBOL	CONDITION	MIN.	TYP.	MAX.	UNIT
1	IF Vcc	Icc1	Supply 5V	27.9	37.2	46.5	mA
14	RGB VCC (9V)	Icc14	Supply 9V	22.8	30.4	38.0	mA
31	H VCC (9V)	Icc31	Supply 9V	14.5	19.3	24.1	mA
37	DIGITAL VDD	Icc37	Supply 3.3V	16.3	21.7	27.1	mA
42	Y/C VCC (5V)	Icc42	Supply 5V	74.4	99.2	124.0	mA

DC CHARACTERISTIC

PIN VOLTAGE

PIN NO.	PIN NAME	SYMBOL	CONDITION	MIN.	TYP.	MAX.	UNIT
2	RIPPLE FILTER	V2		3.1	3.8	4.5	V
3	SIF OUT	V3		1.4	3	3.6	V
4	AUDIO OUT	V4		3.2	3.6	4.2	V
6	IF IN	V6		0.9	1.5	2.1	V
11	APC FILTER	V11		2.5	3.2	3.9	V
12	X'TAL (4.43MHZ)	V12		3	3.3	3.6	V
13	CW OUT	V13		2.9	3.3	3.7	V
16	EXT. R IN	V16		1.5	2.2	2.9	V
17	EXT. G IN	V17		1.5	2.2	2.9	V
18	EXT. B IN	V18		1.5	2.2	2.9	V
20	R OUT	V20		2.15	2.5	2.85	V
21	G OUT	V21		2.15	2.5	2.85	V
22	B OUT	V22		2.15	2.5	2.85	V
23	IK IN	V23		1.1	1.4	1.7	V
27	REF. R	V27		0.8	1.1	1.4	V
28	ABCL IN	V28		5.7	6.1	6.4	V
29	H AFC FILTER	V29		6	6.8	7.5	V
38	SYNC IN	V38		1.9	2.2	2.6	V
39	Y IN	V39		2.1	2.4	2.8	V
40	DC RESTOR	V40		1.5	2.3	3.5	V
41	MON OUT	V41		2.65	3	3.35	V
43	C-IN	V43		1.8	2.1	2.4	V
44	Cr IN	V44		1.7	2.4	3.1	V
45	Cb IN	V45		1.7	2.4	3.1	V
46	EXT IN	V46		1.2	1.5	1.9	V
47	LOOP FILTER	V47		2	2.5	3	V
48	TV IN	V48		1.2	1.5	1.9	V
49	DE-EMP	V49		4	4.5	5	V
50	PIF VCO	V50		2.9	3.5	4.1	V
51	PIF VCO	V51		2.9	3.5	4.1	V
53	EXT AUDIO IN	V53		3.9	4.5	5.1	V
54	IF DET OUT	V54		4.7	5.2	5.7	V
55	AFT OUT	V55		2	2.5	3	V
56	H CORR/SIF IN	V56		2.4	3	3.6	V

AC CHARACTERISTIC

PIF STAGE

ITEM	SYMBOL	TEST CIRCUIT	TEST CONDITON	MIN	TYP	MAX	UNIT
PIF input sensitivity	vin min(p)	-	P1	-	42	47	dB μ V
PIF maximum input signal	vin max(p)	-		100	105	-	
PIF gain control range	RAGC(p)	-		53	63	-	
RF AGC maximum output voltage	VAGC max	-	P2	-	-	-	V
RF AGC minimum output voltage	VAGC min	-		-	-	0.3	
RF AGC delay point (minimum)	v Dly min	-	P3	-	70	80	dB μ V
RF AGC delay point (maximum)	v Dly max	-		100	110	-	
PIF input resistance (*)	Zin R(p)	-	P4	-	-	-	k \bullet pF
PIF input capacitance (*)	Zin C(p)	-		-	-	-	
Differential gain	DG	-	P5	-	2.0	5.0	%
Differential phase	DP	-		-	2.0	5.0	
Intermodulation	I M	-	P6	40	45	-	dB
Video output signal amplitude (Nega)	V Det (p)n	-	P7	2.0	2.2	2.4	V
Video output signal amplitude (Posi)	V Det (p)p	-		2.0	2.2	2.4	
Video output S/N	S/N(p)	-	P8	50	55	-	dB
Synchronous signal level (Nega)	Vsync n	-	P9	-	2.6	-	V
Synchronous signal level (Posi)	Vsync p	-		-	2.6	-	
Video bandwidth (-3dB)	fDet(p)	-	P10	6	8	-	MHz
Capture range of the PLL (Upper)	fpH(p)	-	P11	1.5	3.5	-	MHz
Capture range of the PLL (Lower)	fpL(p)	-		-	-2.2	-1.5	
Hold range of the PLL (Upper)	fhH(p)	-		1.5	3.5	-	
Hold range of the PLL (Lower)	fhL(p)	-		-	-2.2	-1.5	
Control steepness of the VCO	β	-	P12	-	3.0	-	MHz/V
Steepness of the AFT Detection (steep)	SAFT(S)	-	P13	20	25	30	kHz/V
Steepness of the AFT Detection (gentle)	SAFT(G)	-		75	100	125	
AFT maximum output voltage	VAFT max	-		4.5	4.8	-	
AFT minimum output voltage	VAFT min	-	-	0.2	0.5		
AFT output voltage on defeating	\bullet AFT Def	-	P14	2.3	2.5	2.7	

(*) Not tested

SIF STAGE

ITEM	SYMBOL	TEST CIRCUIT	TEST CONDITION	MIN	TYP	MAX	UMIT	
Limiting sensitivity (4.5MHz High)	vin lim(s)4.5MH	-	S1	-	45	50		
Limiting sensitivity (4.5MHz Low)	vin lim(s)4.5ML	-		-	40	45		
Limiting sensitivity (5.5MHz)	vin lim(s)5.5M	-		-	40	45		
Limiting sensitivity (6.0MHz)	vin lim(s)6.0M	-		-	40	45		
Limiting sensitivity (6.5MHz)	vin lim(s)6.5M	-		-	45	50		
AM reduction ratio (4.5MHz High)	AMR4.5MH	-	S2	50	55	-	dB	
AM reduction ratio (4.5MHz Low)	AMR 4.5ML	-		50	55	-		
AM reduction ratio (5.5MHz)	AMR5.5M	-		50	55	-	dB	
AM reduction ratio (6.0MHz)	AMR6.0M	-		50	55	-		
AM reduction ratio (6.5MHz)	AMR6.5M	-		50	55	-		
AF output signal amplitude (4.5MHz High)	vDet(s)4.5MH	-	S3	649	927	1324	mVrms	
AF output S/N AF output signal amplitude (4.5MHz High)	S/N(s)4.5MH	-		50	55	-		dB
Total harmonics distortion AF output signal amplitude (4.5MHz High)	THD4.5MH	-		-	0.5	1.0		
AF output signal amplitude (4.5MHz Low)	vDet(s)4.5ML	-	S4	350	500	710	mVrms	

ITEM	SYMBOL	TEST CIRCUIT	TEST CONDITION	MIN	TYP	MAX	UNIT
AF output S/N AF output signal amplitude (4.5MHz Low)	S/N(s)4.5ML			50	55	-	dB
Total harmonics distortion AF output signal amplitude (4.5MHz Low)	THD4.5ML			-	0.5	1.0	%
AF output signal amplitude (5.5MHz)	vDet(s)5.5M	-	S5	695	927	1236	mVrms
AF output S/N AF output signal amplitude (5.5MHz)	S/N(s)5.5M	-		53	58	-	dB
Total harmonics distortion AF output signal amplitude (5.5MHz)	THD5.5M	-		-	0.5	1.0	%
AF output signal amplitude (6.0MHz)	vDet(s)6.0M	-	S6	695	927	1236	mVrms
AF output S/N AF output signal amplitude (6.0MHz)	S/N(s)6.0M	-		53	58	-	dB
Total harmonics distortion AF output signal amplitude (6.0MHz)	THD6.0M	-		-	0.5	1.0	%
AF output signal amplitude (6.5MHz)	vDet(s)6.5M	-	S7	695	927	1236	mVrms
AF output S/N AF output signal amplitude (6.5MHz)	S/N(s)6.5M	-		53	58	-	dB
Total harmonics distortion AF output signal amplitude (6.5MHz)	THD6.5M	-		-	0.5	1.0	%
Demodulation band width of the FM demodulator (Upper1)	fpH(s)1	-	S8	5.0	-	-	
Demodulation band width of the FM demodulator (Lower1)	fpL(s)1	-		-	-	4.0	
Demodulation band width of the FM demodulator (Upper2)	fpH(s)2	-	S9	7.0	-	-	MHz
Demodulation band width of the FM demodulator (Lower2)	fpL(s)2	-		-	-	5.0	
Audio attenuater gain (Max)	G att max	-	S10	-2	0	2	dB
Audio attenuater gain (Mid)	G att mid	-		-	-15	-	
Audio attenuater gain (Min)	G att min	-		-	-85	-75	
Audio attenuater off-set	Vos att	-	S11	-50	50	+150	mV
Audio switch cross-talk (TV•EXT)	CT(s)T-E	-	S12	-	-75	-65	dB
Audio switch cross-talk (EXT•TV)	CT(s)E-T	-		-	-60	-55	
Audio switch off-set	Vos sw	-	S13	-	-	±30	mV

(*) Not tested

VIDEO STAGE

ITEM	SYMBOL	TEST CIRCUIT	TEST CINDITION	MIN	TYP	MAX	UNIT
TV Input Dynamic range	DR _{TV}		V1	0.9	1.0	•	V p-p
External Input Dynamic Range	DR _{EXT}			0.9	1.0	•	V p-p
TV mode Gain	G _{TV}		V2	5.7	6.0	6.3	dB
External mode Gain	G _{EXT}			5.7	6.0	6.3	dB
AV SW Cross Talk (TV -> Ext)	CT _{SWTE}		V3	-60	-55	-50	dB
AV SW Cross Talk (Ext -> TV)	CT _{SWET}			-60	-55	-50	dB
Y Input Dynamic Range	••Y		V4	0.9	1.0	•	Vp-p
Y Input Pedestal Clamp Voltage	•YCLP		V5	2.5	2.7	2.9	V
Y frequency response	FR _Y		V6	6.5	8.0	•	MHz
Y Delay time	t _{YDEL}		V7	370	460	550	ns
-40ns	t _{YDEL-40}			-44	-38	-34	
240ns	t _{YDEL240}			214	238	254	
1step	t _{YDEL 1step}			34	38	44	
Brightness Control Characteristics	V _{BRTMAX}		V8	2.80	3.25	3.70	V
	V _{BRTCEN}			2.20	2.50	2.80	
	V _{BRTMIN}			1.30	1.75	2.20	
Brightness Control resolution	•V _{BRT}			4.70	11.8	19.0	MV/bit
Uni-color Control Characteristics	•UCYMAX		V9	10.2	11.6	13.2	dB

ITEM	SYMBOL	TEST CIRCUIT	TEST CONDITION	MIN	TYP	MAX	UNIT
	•UCYCEN			4.2	5.7	7.2	
	•UCYMIN			-9.8	-7.8	-5.8	
Sub Contrast Control Characteristics	•SCONMAX		V10	1.5	2.5	3.5	dB
	•SCONMIN			-4.0	-3.0	-2.0	
Sharpness Peaking Frequency	•SHP		V11	2.05	2.75	3.80	MHz
Sharpness Control Characteristics	•SHMAX		V12	3.6	6.6	9.6	dB
	•SHCEN			1.3	3.3	5.	
	•SHMIN			-8.4	-5.4	-2.4	
Y • correction start point	V _Y . 70		V13	70	73	76	IRE
	V _Y . 80			77	80	83	
	V _Y . 90			84	87	90	
Y • correction curve	G _Y .				-5		dB
Black Expansion AMP Gain	•BLEX		V14	1.05	1.2	1.45	
Black Expansion Start Point	V _{BLEX 25IRE}			21	25	29	V
	V _{BLEX 35IRE}			30	34	38	
	V _{BLEX 45IRE}			39	43	47	
DC restration gain	V _{dcrest85}		V15	85	90	95	IRE
	V _{dcrest120}			110	115	120	
	V _{dcrest step}			5	8	11	
WPS Level	V _{WPS}		V16	2.5	2.8	3.3	V _{p-p}
Chroma Trap Gain	G _{TRAP358}		V17	•	-29	-25	dB
	G _{TRAP443}			•	-27	-23	
Half Tone reduction for Y	G _{HTY}		V18	-6.5	-6	-5.5	dB

CHROMA STAGE

ITEM	SYMBOL	TEST CIRCUIT	TEST CONDITION	MIN	TYP	MAX	UNIT
ACC Chara.	•ACCL		C1	•	25	40	mV p-p
	•ACCH			600	1000	•	
TOF Chara.(4.43)	fo		C2	•	5.16	•	MHz
	Q			•T443	•	1.86	
BPF Chara. (4.43)	fo			•	4.45	•	MHz
	Q			•B443	•	1.86	
TOF Chara. (3.58)	fo			•	4.30	•	MHz
	Q			•T358	•	1.92	
BPF Chara. (3.58)	fo			•	3.67	•	MHz
	Q			•B358	•	1.92	
C Delay Time (P/N)	t _{CDELPN}		C3	595	700	805	ns
C Delay Time (SECAM)	t _{CDELS}			510	600	690	
Time Difference between Y / C	•t _{Y/C}			765	900	1035	
Color Control Characteristics	MAX		C4	-60	0	60	dB
	MIN			•COLMAX	4.0	6.5	
Uni-Color Control Characteristics	•COLMIN		C5	•	•	-20	dB
	•UCCMIN			-27	-24	-21	
TINT Chara.(4.43NTSC)	MAX		C6	•	•	•	deg
	MIN			••443MAX	28	42	
TINT Chara.(3.58NTSC)	MAX			-28	-42	-56	
	MIN			••358MAX	28	42	
Relative Amplitude (PAL)	R/B		C7	•	•	•	•
	G/B			V _{PR/B}	0.47	0.57	
Relative Amplitude (NTSC1)	R/B			0.31	0.38	0.45	
	G/B			V _{NR/B}	0.62	0.72	
Relative Amplitude (NTSC2)	R/B			0.26	0.32	0.38	
	G/B			V _{NG/B}	0.70	0.80	
Relative Amplitude (DVD)	R/B			0.24	0.30	0.36	
	G/B			V _{NR/B}	0.67	0.77	
				0.36	0.44	0.52	

ITEM	SYMBOL	TEST CIRCUIT	TEST CINDITION	MIN	TYP	MAX	UNIT				
Relative Phase (PAL)	R-B	•PR-B		C8	84	89	94	deg			
	G-B	•PG-B			230	236	242				
Relative Phase (NTSC1)	R-B	•N1R-B			83	89.5	95				
	G-B	•N1G-B			232	241	248				
Relative Phase (NTSC2)	R-B	•N2R-B			95	105	115				
	G-B	•N2G-B			232	240	248				
Relative Phase (DVD)	R-B	•DVDR-B			86	92.8	100				
	G-B	•DVDG-B			236	245	254				
APC Pull- In Range (4.43MHz)		•4APCP+				C9	350		500	2500	Hz
		•4APCP-					350		500	-2500	
APC Hold Range (4.43MHz)		•4APCH+	350	500			2500				
		•4APCH-	350	500			-2500				
APC Pull-In Range (3.58MHz)		•3APCP+	300	500			2500				
		•3APCP-	300	500			-2500				
APC Hold Range (3.58MHz)		•3APCH+	300	500			2500				
		•3APCH-	300	500			-2500				
APC Control Sensitivity (4.43MHz)		•443		C10			1.5	2.5	3.5	Hz/mV	
APC Control Sensitivity (3.58MHz)		•358					0.6	1.1	1.6		
PAL ID Sensitivity (Normal Mode)		•PIDON		C11	0.7	1.5	3	mVp-p			
		•PIDOFF			1.0	1.9	4				
PAL ID Sensitivity (Low Mode)		•PIDLON			1.7	3.4	6				
		•PIDLOFF			2.5	5.0	8				
NTSC ID Sensitivity (Normal Mode)		•NIDON			0.6	1.3	2.6				
		•NIDOFF			1.0	2.1	4.2				
NTSC ID Sensitivity (Low Mode)		•NIDLON			2.0	4	7				
		•NIDLOFF			4.0	8	12				
CWOUT Amplitude		•CW				C12	0.35		0.5	0.65	V p-p
DC Bias at killer on		V _{BCWKON}					1.0		1.5	2.0	V
DC Bias at killer off		V _{BCWKOFF}	3.0	3.5			4.0				
Half Tone Chara. for C		•HTC		C13	-6.7	-6.0	-5.3	dB			
Sub-Color Control	MAX	•SCOLMAX		C14	+2.5	+3.5	4.5	dB			
Characteristics	MIN	•SCOLMIN			-4.5	-3.5	-2.5				
1H Delay Time		T _{BDL}		•		64		•s			
		T _{RDL}				64					

SECAM STAGE

ITEM	SYMBOL	TEST CIRCUIT	TEST CINDITION	MIN	TYP	MAX	UNIT
Bell Monitor Output Amplitude	embo		SE1	63	100	163	mV p-p
Bell Filter f ₀	f _{0B-C}		SE2	-23	0	23	kHz
Bell Filter f ₀ Variable Range	f _{0B-VR}		SE3	15	30	45	
Bell Filter Q	Q _{BEL}		SE4	13	15	17	Vp-p
Color Difference Output Amplitude	VBS		SE5	1.29	1.85	2.41	
	VRS			1.12	1.57	2.22	
Color Difference Relative Amplitude	R/B-S		SE6	0.7	0.80	0.90	-
Color Difference S/N Ratio	SNB-S		SE8	-38	-34	-28	dB
	SBR-S			-44	-39	-32	
Linearity	LinB		SE9	85	100	117	%
	LinR			85	100	117	
Rising-Fall Time	trfB		SE10	-	1.1	1.5	•s
	trfR			-	1.1	1.5	
SECAM ID Sensitivity (Normal Mode)	H	•SIDHON	SE11	0.66	1.32	2.64	mV
		•SIDHOFF		1.82	3.64	6.5	

ITEM	SYMBOL	TEST CIRCUIT	TEST CINDITION	MIN	TYP	MAX	UNIT
SECAM ID Sensitivity (Low Mode)	H+V	•SIDHVON		0.6	1.20	2.4	
		•SIDHVOFF		1.0	1.9	3.8	
	H	•SIDLHON		1.7	3.3	6.0	
		•SIDLHOFF		4.5	9	14	
	H+V	•SIDLHVON		1.1	2.2	4.4	
Gate Pulse Width Variable Range	WGP ₊₂₀₀		SE12	1.7	1.8	1.9	•s
	WGP			1.9	2.0	2.1	
	WGP ₋₂₀₀			2.1	2.2	2.3	
SECAM black adjustment characteristic	V _{SBMAX}		SE13	80	85	90	mV
	V _{SRMAX}			80	85	90	
	V _{SRMIN}			-97	-92	-87	
	V _{SRMIN}			-97	-92	-87	
SECAM black adjustment sensitivity	•V _{SB}			12	14	16	
	•V _{SR}			12	14	16	

TEXT STAGE

ITEM	SYMBOL	TEST CIRCUIT	TEST CINDITION	MIN	TYP	MAX	UNIT
V-BLK Pulse Output Level	•VBLK		T1	0.1	0.6	1.1	V
H-BLK Pulse Output Level	•HBLK			0.1	0.6	1.1	
RGB Output Black Level (0IRE DC)	•BLACK		T2	2.25	2.5	2.75	V
RGB Output White Level (100IRE AC)	•WHITE		T3	•	2.50	•	Vp-p
Cut-Off Voltage Variable Range	•CUT+		T4	0.6	0.65	0.7	V
	•CUT-			-0.7	-0.65	-0.6	
Drive Control Variable Range	•DR+		T5	2.5	3.5	4.5	dB
	•DR-			-8.0	-5.5	-4.5	
ABCL Control Voltage Range	•ABCLH		T6	5.7	6.0	6.3	V
	•ABCLL			4.5	4.8	5.1	
ACL Gain	•ACL			-21	-19	-17	dB
ABL Point	•ABLP1		T7	-0.1	0	0.1	V
	•ABLP2			-0.3	-0.2	-0.1	
	•ABLP3			-0.4	-0.3	-0.2	
	•ABLP4			-0.6	-0.5	-0.3	
ABL Gain	•ABLG1		T8	-0.31	-0.21	-0.11	V
	•ABLG2			-0.48	-0.38	-0.28	
	•ABLG3			-0.60	-0.50	-0.40	
	•ABLG4			-0.77	-0.67	-0.57	
Analog RGB Dynamic Range	••TX		T9	0.7	-	-	Vp-p
Analog RGB Contrast Control MAX. Characteristic CEN.	•TXCMAX		T10	0.59	0.74	0.94	Vp-p
	•TXCCEN			0.34	0.41	0.49	
	MIN.	•TXCMIN			0.06	0.08	
Analog RGB Brightness MAX. Control Characteristic CEN.	•TXBRMAX		T11	2.8	3.25	3.7	Vp-p
	•TXBRCEN			2.2	2.5	2.8	
	MIN.	•TXBRMIN			1.3	1.75	
Analog RGB Mode Switching Level	•YSHALF •YSBLK		T12		3.3 0.7		V
Analog RGB Mode Transfer Characteristic	••YS		T13	•	40	100	ns
	t••YS			•	40	100	
	••YS			•	40	100	
	t••YS			•	40	100	
Half Tone Mode Switching Level	•HT		T14		0.7		V
Cross Talk from Analog RGB to••	••TX-TV		T15	•	-55	-40	dB
Cross Talk from •• to Analog RGB•	••TV-TX		T16	•	-55	-40	dB

ITEM	SYMBOL	TEST CIRCUIT	TEST CINDITION	MIN	TYP	MAX	UNIT
Baseband TINT Characteristic	••BBMAX		T17	7	12	17	deg
	••BBMIN			-7	-12	-17	
Analog RGB / RGB Output Voltage Axes Difference	•V _{R-G}		T18	-40		40	mV
	•V _{G-B}			-40		40	
	•V _{B-R}			-40		40	

DEF STAGE

ITEM	SYMBOL	TEST CIRCUIT	TEST CINDITION	MIN	TYP	MAX	UNIT
AFC Inactive Period	50Hz •50AFCOFF		••	•	308-7	•	H
	60Hz •60AFCOFF			•	260-10	•	
H-OUT Start Voltage	•HON		••	4.7	5.0	5.3	•
H-OUT Pulse Duty	•HOUT		••	38.5	40.5	42.5	•
H-OUT Freq. On AFC Stop Mode	•HAFCOFF		••	15.585	15.734	15.885	kHz
Horizontal Free-Run Frequency	50Hz •H50FR		••	15.475	15.625	15.775	kHz
	60Hz •H60FR			15.585	15.734	15.885	
Horizontal Freq. Variable Range	MAX. •HMAX		••	16.200	16.400	16.600	kHz
	MIN. •HMIN			14.600	14.900	15.200	
Horizontal Freq. Control Sensitivity	•HAFC		••	1.3	1.8	2.3	Hz/mV
Horizontal Pull-In Range	•HPH		••	500	•	•	Hz
	•HPL			500	•	•	
H-OUT Voltage	•HOUTH •HOUT		••	4.0 •	4.4 0.15	4.8 0.30	V
Horizontal Freq. Dependence on •cc	••HVCC		•••	-20	0	20	Hz/V
FBP Phase	••FBP		•••	2.7	3.2	3.7	•s
H-Sync. Phase	••HSYNC			0.2	0.3	0.4	
Horizontal Position Variable Range	•••HPOS		•••	6.3	6.8	7.3	•s
AFC-2 Pulse Threshold Level	•AFC2		•••	3.3	3.6	3.9	V
H-BLK Pulse Threshold Level	•HBLK		•••	0.8	1.3	1.6	
BLACK Peak Det. Stop Period (H)	•HBPDET		•••	7.5	8.0	8.5	•s
	•BPDET			13.5	14.0	14.5	
Gate Pulse Start Phase	••GP		••6	2.8	3.0	3.2	•s
Gate Pulse Width	•GP			1.8	2.0	2.2	
Vertical Oscillation Start Voltage	•VON		••7	4.7	5.0	5.3	V
Vertical Free-Run Frequency	Auto ₅₀ •VAUFR50		•18	45	50	55	Hz
	Auto ₆₀ •VAUFR60			55	60	65	
	50Hz •V50FR			45	50	55	
	60Hz •V60FR			55	60	65	
Gate Pulse V-Masking Period	50Hz •50GPM		•19	•	308-7	•	H
	60Hz •60GPM			•	260-10	•	
V.Ramp DC on Service Mode	•NOVRAMP		•20	3.0	3.2	3.4	V
Vertical Pull-In Range (Auto)	•VPAUL		•21	•	224.5	•	H
	•VPAUH			•	343.5	•	
Vertical Pull-In Range (50Hz)	F _{VP50L}				274.5		
	F _{VP50H}				343.5		
Vertical Pull-In Range (60Hz)	•VP60L			•	224.5	•	
	•VP60H			•	293.5	•	
Vertical Period on Fixed Mode	T _{V312.5}		•22		312.5		H
	T _{V262.5}				262.5		
	T _{V313}				313		
	•V263			•	263	•	
V-BLK Start Phase	50Hz ••50VBLK		•23	27	29	31	•s
	60Hz ••60VBLK			27	29	31	
V-BLK Width	50Hz •50VBLK			•	22	•	H
	60Hz •60VBLK			•	18	•	

ITEM	SYMBOL	TEST CIRCUIT	TEST CINDITION	MIN	TYP	MAX	UNIT
Sand Castle Pulse Level	•SCPH		•24	6.70	7.00	7.30	V
	•SCPM			4.60	4.90	5.20	
	•SCPL			1.55	1.85	2.15	
Vertical Ramp Amplitude	•VRAMP		•25	1.50	1.67	1.83	Vp-p
Vertical AMP Gain	•VAMP		•26	18	22	26	dB
Vertical AMP MAX. Output Level	•VOMAX			1.8	2.3	2.8	V
Vertical AMP Min. Output Level	•VOMIN			•	0.0	0.3	
Vertical AMP Max. Output Current	•VOMAX			•27	11	15	19
Vertical NFB Amplitude	•NFB		•28	1.74	1.90	2.06	Vp-p
Vertical Amplitude Variable Range	••VRAMPH			43	47	51	%
	••VRAMPL			-51	-47	-43	
Vertical Linearity Variable Range	••LIN1+		•29	-23	-21	-18	%
	••LIN1-			21	24	27	
	••LIN2+			17	20	23	
	••LIN2-			-28	-25	-22	
Vertical S Correction Variable Range	••S1+		•30	-26	-23	-20	%
	••S1-			21	24	27	
	••S2+			-26	-23	-20	
	••S2-			21	24	27	
Vertical Guard Voltage	•VG		•31	1.80	2.00	2.20	V

TEST CONDITION

PIF STAGE

Note	Items/Symbols	Bus conditions	Measurement methods
P1	PIF Input Sensitivity / vin min(p) PIF maximum input signal / vin max(p) PIF gain control range / RAGC(p)	RF AGC:except 0 PIF Freq. : 38.9MHz VCO Adj. Center : • 0/1 Others : Preset	(1)Input a signal that 38.9[MHz], 90[dB μ V], and 30 [%] modulated by 15 [kHz] sine wave at pin 6. (2)Set the bit of "VCO Adj. Req." to "1", and set the bit of "VCO Adj. Req." to "0". (3)Measure the amplitude at Pin 54(vo#54 [Vp-p]). (4)Decreasing the IF input level, measure the input level at which the output amplitude at pin 54 turns to be -3dB against "vo#54" (vin min(p)[dB μ V]). (5)Increasing the IF input level, measure the input level at which the output amplitude at pin 54 turns to be -1dB against "vo#54" (vin min(p)[dB μ V]). (6)RAGC(p)[dB] = vin max(p) - vin min(p)
P2	RF AGC output voltage / VAGC max / VAGC min	RF AGC:•:•Adjust PIF Freq. : 38.9MHz VCO Adj. Req.: •0/1 Others : Preset	(1)Input a 38.9[MHz], 90[dB μ V] signal at pin 6. (2)Set the bit of "VCO Adj. Req." to "1", and set the bit of "VCO Adj. Req." to "0". (3)Adjust RF AGC so that the pin 9 voltage is 4.5V. (4)Increase the IF input level to 107dB μ V. (5)Measure the pin 9 voltage (VAGC min[V]). (6)Connect pin 6 and pin 7 to GND. (7)Measure the pin 9 voltage (VAGC max[V]).
P3	RF delay point / v Dly min / v Dly max	RF AGC:•:•Adjust PIF Freq. 38.9MHz VCO Adj. Req. : •0/1 RF AGC: 01/3F Others : Preset	(1)Input a 38.9[MHz], 90[dB μ V] signal at pin 6. (2)Set the bit of "VCO Adj. Req." to "1", and set the bit of "VCO Adj. Req." to "0". (3)Set the data of "RF AGC" to 01(h). (4)Decrease the IF input level, measure the input level at which the voltage at pin 9 turn to be 4.5[V] (v Dly min[dB μ V]). (5)Set the data of "RF AGC" to 3F(h). (6)Increase the IF input level, measure the input level at which the voltage at pin 9 turn to be 4.5[V] (v Dly max[dB μ V]).
P4	PIF input resistance / Zin R(p) PIF input capacitance / Zin C(p)	Preset	(1)Remove all connection from pin 6 and pin 7. (2)Measure the resistance (Zin R(p)[k Ω]) and capacitance (Zin C(p)[pF]) of pin 6 and pin 7 by the impedance meter.
P5	Differential Gain / DG Differential Phase / DP	RF AGC:except 0 PIF Freq.: 38.9MHz VCO Adj. Req.: 0/1 Vi Pol:0/1 Others : Preset	(1)Input a signal that 38.9[MHz], 90[dB μ V], and 87.5 [%] modulated by 10 stair video signal at pin 6. (2)Set the bit of "VCO Adj. Req." to "1", and set the bit of "VCO Adj. Req." to "0". (3)Measure "DG[%]" and "DP[deg]" for Pin54 output.
P6	Intermodulation / IM	RF AGC:except 0 PIF Freq. : 38.9MHz VCO Adj. Req.: 0/1 Others : Preset	(1)Input a signal composed of following 3 signals at pin 6; 38.90[MHz]/90[dB μ V], 34.47[MHz]/80dB μ V 33.40[MHz]/80[dB μ V] (2)Set the bit of "VCO Adj. Req." to "1", and set the bit of "VCO Adj. Req." to "0". (3)Adjust pin 10 voltage so that the bottom of pin 54 output is equal to sync. tip level. (4)Measure the 1.07[MHz] level against the 4.43[MHz] level(=0[dB]) (IM[dB]).

Note	Items/Symbols	Bus conditions	Measurement methods
P7	Video output signal amplitude / vDet(p)n / vDet(p)p	RF AGC:except 0 PIF Freq. : 38.9MHz VCO Adj. Req. : 0/1 L-SECAM MODE :0/1 Others : Preset	(1)Input a signal that 38.9[MHz], 90[dBμV], and 87.5 [%] negative modulated by 100% white video signal at pin 6. (2)Set the bit of "VCO Adj. Req." to "1", and set the bit of "VCO Adj. Req." to "0". (3)Set the bit of "L-SECAM MODE" to "0". (4)Measure the amplitude of the pin 54 output signal (vDet(p)n[Vp-p]). (5)Input a signal that 38.9[MHz], 90[dBμV], and 97 [%] positive modulated by 100% white video signal at pin 6. (6)Set the bit of "L-SECAM MODE" to "1". (7)Measure the amplitude of the pin 54 output signal (vDet(p)p[Vp-p]).
P8	Video output S/N / S/N(p)	RF AGC:except 0 PIF Freq. : 38.9MHz VCO Adj. Req. : 0/1 Others : Preset	(1)Input a signal that 38.9[MHz], 90[dBμV], and 87.5 [%] modulated by black video signal at pin 6. (2)Set the bit of "VCO Adj. Req." to "1", and set the bit of "VCO Adj. Req." to "0". (3)Measure the video S/N for pin 54 output (HPF : 100[kHz], LPF : 5[MHz], CCIR weighted) (S/N(p)[dB]).
P9	Synchronous signal level / Vsync n / Vsync p	RF AGC:except 0 PIF Freq. : 38.9MHz VCO Adj. Req.: 0/1 L-SECAM MODE :0/1 Others : Preset	(1)Input a signal that 38.9[MHz], 90[dBμV], 87.5[%] negative modulated by 100% white signal at pin 6. (2)Set the bit of "VCO Adj. Req." to "1", and set the bit of "VCO Adj. Req." to "0". (3)Set the bit of "L-SECAM MODE" to "0". (4)Measure the voltage of the sync. tip at pin 54 (Vsync n[V]). (5)Input a signal that 38.9[MHz], 90[dBμV], and 97 [%] positive modulated by 100% white video signal at pin 6. (6)Set the bit of "L-SECAM MODE" to "1". (7)Measure the voltage of the sync. tip at pin 54 (Vsync p[V]).
P10	Video bandwidth (-3dB) / fDet(p)	RF AGC:except 0 PIF Freq.: 38.9MHz VCO Adj. Req.: 0/1 L-SECAM MODE :0/1 Others : Preset	(1)Input the mixture of 2 signals (signal1 : 38.9[MHz]/82[dBμV], signal 2 : 38.8[MHz]/69[dBμV]) to pin 6. (2)Set the bit of "VCO Adj. Req." to "1", and set the bit of "VCO Adj. Req." to "0". (3)Measure the minimum voltage of the output signal at pin 54 (Vo#54). (4)Apply the DC voltage to pin 10 and adjust it so that the minimum voltage of the output signal at pin 54 is equal to Vo#54. (5)Decrease frequency of the input signal 2 at pin 6, and measure amplitude of the output signal at pin 54. (6)Measure fDet(p) shown as below.

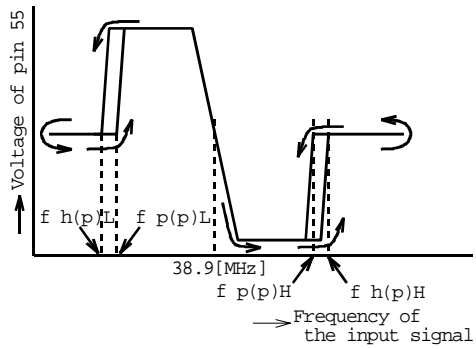
Note	Items/Symbols	Bus conditions	Measurement methods
P11	Capture range of the PLL / fpH(p) / fpL(p) Hold range of the PLL / fhH(p) / fhL(p)	RF AGC : except 0 PIF Freq. : 38.9MHz VCO Adj. Req. : 0/1 Others : Preset	(1) Input a signal that 38.9[MHz], 90[dBμV] at pin 6. (2) Set the bit of "VCO Adj. Req." to "1", and set the bit of "VCO Adj. Req." to "0". (3) Sweep down the input signal frequency to 34.9[MHz], and sweep up to 43.9[MHz]. Sweep down the input signal frequency to 38.9[MHz]. (4) Measure the voltage at pin 55 and measure the frequency of the input signal shown as below. 
P12	Control steepness of the VCO / β	PIF Freq. : 38.9MHz VCO Adj. Req. : 0/1 Others : Preset	(1) Set the bit of "VCO Adj. Req." to "1", and set the bit of "VCO Adj. Req." to "0". (2) Set the FET probe which connected to the spectrum analyzer near by pin 50 or pin 51 (Don't touch the probe directly to pin 50 or to pin 51). (3) Apply 2.3[V] to pin 47, and measure frequency of the VCO oscillation by the spectrum analyzer (fLVCO[MHz]). (4) Apply 2.7[V] to pin 47, and measure frequency of the VCO oscillation by the spectrum analyzer (fHVCO[MHz]). (5) $\beta[\text{MHz/V}] = (\text{fHVCO} - \text{fLVCO}) / 0.4$
P13	Steepness of the AFT detection / S AFT AFT Voltage / VAFTmax / VAFTmin	PIF Freq. : 38.9MHz VCO Adj. Req.: 0/1 Others : Preset	(1) Input a 38.9[MHz], 90[dBμV] signal at pin 6. (2) Set the bit of "VCO Adj. Req." to "1", and set the bit of "VCO Adj. Req." to "0". (3) Input a 38.9[MHz]-20[kHz], 90[dBμV], non-modulation signal at pin 6. (4) Measure the voltage at pin 55 (VH#55[V]). (5) Input a 38.9[MHz]+20[kHz], 90[dBμV], non-modulation signal at pin 6. (6) Measure the voltage at pin 55 (VL#55[V]). (7) $S\ AFT[\text{kHz/V}] = 40 / (\text{VH}\#55 - \text{VL}\#55)$ (8) Input a 38.9[MHz]-500[kHz], 90[dBμV], non-modulation signal at pin 6. (9) Measure the voltage at pin 55 (VAFTmax[V]). (10) Input a 38.9[MHz]+500[kHz], 90[dBμV], non-modulation signal at pin 6. (11) Measure the voltage at pin 55 (VAFTmin[V]).
P14	AFT output voltage on defeating	Preset	(1) Measure the voltage at pin 55 (VAFT Def[V]).

SIF STAGE

Note	Items/Symbols	Bus conditions	Measurement methods
S1	Limiting sensitivity / vin lim(s)4.5MH / vin lim(s)4.5ML / vin lim(s)5.5M / vin lim(s)6.0M / vin lim(s)6.5M	SIF-Freq. : 4.5M/5.5M/6.0M/ 6.5M AUDIO ATT : 127 Others : Preset	(1) Set the bits of "SIF-Freq." to "11". (2) Input a signal that 4.5[MHz], 100[dB μ V], 25[kHz] deviated by 400[Hz] sine wave at pin 56. (3) Measure the amplitude at pin 4 (vo#4[mVrms]). (4) Decreasing the 4.5[MHz] signal level, measure the 4.5[MHz] signal level at which the amplitude at pin 4 turns to be -3[dB] against "vo#4" (vin lim(s)4.5MH[dB μ V]). (5) Input a signal that 4.5[MHz], 100[dB μ V], 25[kHz] deviated by 400[Hz] sine wave at pin 56. (6) Do same measuring as above (3)~(4) (vin lim(s)4.5ML). (7) Set the bits of "SIF-Freq." to "00". (8) Change the frequency of the input signal to 5.5MHz, and change the deviation of the input signal to 50[kHz]. (9) Do same measuring as above (3)~(4) (vin lim(s)5.5M). (10) Set the bits of "SIF-Freq." to "01". (11) Change the frequency of the input signal to 6.0MHz, and do same measuring as above (3)~(4) (vin lim(s)6.0M). (12) Set the bits of "SIF-Freq." to "10". (13) Change the frequency of the input signal to 6.5MHz, and do same measuring as above (3)~(4) (vin lim(s)6.5M).
S2	AM reduction ratio / AMR4.5MH / AMR4.5ML / AMR5.5M / AMR6.0M / AMR6.5M	SIF-Freq. : 4.5M/5.5M/6.0M/ 6.5M AUDIO ATT : 127 Others : Preset	(1) Set the bits of "SIF-Freq." to "11". (2) Input a signal that 4.5[MHz], 100[dB μ V], 25[kHz] deviated by 400[Hz] sine wave at pin 56. (3) Measure the amplitude at pin 4 (vo#4[mVrms]). (4) Input a signal that 4.5[MHz], 100[dB μ V], and 30 [%] modulated by 400 [Hz] sine wave at pin 56. (5) Measure the amplitude at pin 4 (v#4[mVrms]). (6) $AMR4.5H[dB] = 20\log(v\#4/vo\#4)$ (7) Input a signal that 4.5[MHz], 100[dB μ V], 25[kHz] deviated by 400[Hz] sine wave at pin 56. (8) Do same measuring as above (3)~(6) (AMR4.5ML). (9) Set the bits of "SIF-Freq." to "00". (10) Change the frequency of the input signals to 5.5MHz, and change the deviation of the input signal to 50[kHz]. (11) Do same measuring as above (3)~(6) (AMR5.5M). (12) Set the bits of "SIF-Freq." to "01". (13) Change the frequency of the input signals to 6.0MHz, and do same measuring as above (3)~(6) (AMR6.0M). (14) Set the bits of "SIF-Freq." to "10". (15) Change the frequency of the input signals to 6.5MHz, and do same measuring as above (3)~(6) (AMR6.5M).
S3	AF output signal amplitude / vDet(s)4.5MH AF output S/N / S/N(s)4.5MH Total harmonics distortion / THD4.5MH	SIF-Freq. : 4.5M AUDIO ATT : 127 Others : Preset	(1)Input a signal that 4.5[MHz], 100[dB μ V], 25[kHz] deviated by 1[kHz] sine wave at pin 56. (2)Measure the amplitude at pin 4 (vDet(s)4.5MH[mVrms]). (3)Measure the total harmonics distortion at pin 4 (THD4.5MH[%]). (4)Input a 4.5[MHz], 100[dB μ V] signal at pin 56. (5)Measure the amplitude at pin 4 (vn(s)[mVrms]). (6) $S/N4.5MH[dB] = 20\log(vDet(s)/vn(s))$
S4	AF output signal amplitude / vDet(s)4.5ML AF output S/N / S/N(s)4.5ML Total harmonics distortion / THD4.5ML	SIF-Freq. : 4.5M AUDIO ATT : 127 Others : Preset	(1)Input a signal that 4.5[MHz], 100[dB μ V], 25[kHz] deviated by 1[kHz] sine wave at pin 56. (2)Do same measuring as vDet(s)4.5MH et al. (vDet(s)4.5ML, S/N(s)4.5ML, THD4.5ML).

Note	Items/Symbols	Bus conditions	Measurement methods
S5	AF output signal amplitude / vDet(s)5.5M AF output S/N / S/N(s)5.5M Total harmonics distortion / THD5.5M	SIF-Freq. :5.5M AUDIO ATT : 127 Others : Preset	(1)Input a signal that 5.5[MHz], 100[dB μ V], 50[kHz] deviated by 400[Hz] sine wave at pin 56. (2)Do same measuring as vDet(s)4.5MH et al. (vDet(s)5.5M, S/N(s)5.5M, THD5.5M).
S6	AF output signal amplitude / vDet(s)6.0M AF output S/N / S/N(s)6.0M Total harmonics distortion / THD6.0M	SIF-Freq. : 6.0M AUDIO ATT : 127 Others : Preset	(1)Input a signal that 6.0[MHz], 100[dB μ V], 50[kHz] deviated by 400[Hz] sine wave at pin 56. (2)Do same measuring as vDet(s)4.5MH et al. (vDet(s)6.0M, S/N(s)6.0M, THD6.0M).
S7	AF output signal amplitude / vDet(s)6.5M AF output S/N / S/N(s)6.5M Total harmonics distortion / THD6.5M	SIF-Freq. : 6.5M AUDIO ATT : 127 Others : Preset	(1)Input a signal that 6.5[MHz], 100[dB μ V], 50[kHz] deviated by 400[Hz] sine wave at pin 56. (2)Do same measuring as vDet(s)4.5MH et al. (vDet(s)6.5M, S/N(s)6.5M, THD6.5M).
S8	Demodulation band width of the FM demodulator / fpH(s)1 / fpL(s)1	SIF-Freq. : 4.5M AUDIO ATT : 127 Others : Preset	(1)Input a signal that 4.5[MHz], 100[dB μ V], 25[kHz] deviated by 400[Hz] sine wave at pin 56. (2)Measure the amplitude at pin 4(vo#4 [Vp-p]). (3)Increase the input signal frequency, measure the input signal frequency at which the output amplitude at pin 4 turn to be -3[dB] against "vo#4" (fpH(s)1[MHz]) (4)Decrease the input signal frequency, measure the input signal frequency at which the output amplitude at pin 4 turn to be -3[dB] against "vo#4" (fpL(s)1[MHz])
S9	Demodulation band width of the FM demodulator / fpH(s)2 / fpL(s)2	SIF-Freq. : 5.5M AUDIO ATT : 127 Others : Preset	(1)Input a signal that 5.5[MHz], 100[dB μ V], 50[kHz] deviated by 400[Hz] sine wave at pin 56. (2)Measure the amplitude at pin 4(vo#4 [Vp-p]). (3)Increase the input signal frequency, measure the input signal frequency at which the output amplitude at pin 4 turn to be -3[dB] against "vo#4" (fpH(s)2[MHz]) (4)Decrease the input signal frequency, measure the input signal frequency at which the output amplitude at pin 4 turn to be -3[dB] against "vo#4" (fpL(s)2[MHz])
S10	Audio attenuater gain / G att max / G att mid / G att min	AUDIO-SW : 1 AUDIO ATT : 0/64/127 Others : Preset	(1) Input a 400[Hz], 927[mVrms] sine wave at pin 53. (2) Set the "AUDIO ATT" data to "127". (3) Measure the amplitude at pin 4 (v#4max[mVrms]). (4) G att max[dB] = 20log(v#4max/927) (5) Set the "AUDIO ATT" data to "64". (6) Measure the amplitude at pin 4 (v#4mid[mVrms]). (7) G att mid[dB] = 20log(v#4mid/927) (8) Set the "AUDIO ATT" data to "0". (9) Measure the amplitude at pin 4 (v#4min[mVrms]). (10) G att min[dB] = 20log(v#4min/927)
S11	Audio attenuater off-set / Vos att	AUDIO-SW : 1 AUDIO ATT : 0/127 Other : Preset	(1) Connect pin 53 to GND through a 4.7[μ F] capacitor. (2) Set the "AUDIO ATT" data to "127". (3) Measure the DC voltage at pin 4 (V#4max[mV]). (4) Set the "AUDIO ATT" data to "0". (5) Measure the DC voltage at pin 4 (V#4min[mV]). (6) Vos[mV] = V#4min-V#4max

Note	Items/Symbols	Bus conditions	Measurement methods
S12	Audio switch cross-talk / CT(s)T-E / CT(s)E-T	SIF-Freq. : 5.5M AUDIO-SW : 0/1 AUDIO ATT : 127 Other : Preset	<ol style="list-style-type: none"> (1) Input a signal that 5.5[MHz], 100[dBμV], 50[kHz] deviated by 1[kHz] sine wave at pin 56. (2) Connect pin 53 to GND through a 4.7[μF] capacitor. (3) Measure level of the 1[kHz] at pin 4 (v#4T1[dBμV]). (4) Set the bit of "AUDIO-SW" to "1". (5) Measure level of the 1[kHz] at pin 4 (v#4E1[dBμV]). (6) CT(s)T-E[dB] = v#4E1-v#4T1 (7) Input a 5.5[MHz], 100[dBμV] signal at pin 56. (8) Measure level of the 1[kHz] at pin 4 (v#4E2[dBμV]). (9) Input a 1[kHz], 927[mVrms] signal at pin 53. (10) Set the bit of "AUDIO-SW" to "0". (11) Measure level of the 1[kHz] at pin 4 (v#4T2[dBμV]). (12) CT(s)E-T[dB] = v#4T2-v#4E2
S13	Audio switch off-set / Vos sw	SIF-Freq. : 5.5M AUDIO-SW : 0/1 AUDIO ATT : 127 Other : Preset	<ol style="list-style-type: none"> (1) Input a 5.5[MHz], 100[dBμV] signal at pin 56. (2) Connect pin 53 to GND through a 4.7[μF] capacitor. (3) Set the bit of "AUDIO-SW" to "0". (4) Measure the voltage at pin 4 (V#4T[V]). (5) Set the bit of "AUDIO-SW" to "1". (6) Measure the voltage at pin 4 (V#E[V]). (7) Vos sw[V] = V#4E-V#4T

VIDEO stage (RGB Mute:0 / R cut off:127 / DC rest.:10)

Note	Items/Symbols	Bus conditions	Measurement methods
V1	TV Input Dynamic Range / DR _{TV} External Input Dynamic Range / DR _{EXT}	Video SW:00/01 Others:Preset	(1)Input a white signal with sync into Pin46(EXT IN)&48(TV IN). (2)Increasing the input amplitude, measure the amplitude(include sync) at which the Pin41(MON OUT) output is clipped, that is "DR _{TV} "(Video SW:00) / "DR _{EXT} "(Video SW:01).
V2	TV Mode Gain / G _{TV} Ext. Mode Gain / G _{EXT}	Video SW:00/01 Others:Preset	(1)Input a 1Vp-p, white signal with sync into Pin46(EXT IN)&48(TV IN). (2)Set Video SW to 00 and measure the gain between PIN48 and Pin41(MON OUT), that is "G _{TV} ". (3)Set Video SW to 01 and measure the gain between Pin46 and Pin41, that is "G _{EXT} ".
V3	AV SW Cross-Talk / CT _{SWTE} / CT _{SWET}	Video SW:00/01 Others:Preset	(1)Input a PAL red signal with sync into Pin48(TV IN) and connect Pin46(EXT IN) to GND via a 1uF capacitor. (2)Set Video SW 01, measure the amplitude of 4.43MHz signal at Pin41 and calculate the cross-talk, that is "CT _{SWTE} ". (3)Input a PAL red signal with sync into Pin46 and connect Pin48 to GND via a 1uF capacitor. (4)Set Video SW 00, measure the the amplitude of 4.43MHz signal at Pin41 and calculate the cross-talk, that is "CT _{SWET} ".
V4	Y Input Dynamic Range / DR _Y	WPS:1 Uni-Color:63 Brightness:0 Color:0 RGB Mute:0 R cut off:63 DC rest.:10 Others:Preset	(1)Input a white signal with sync into Pin38&39. (2)Increasing the Pin39 input amplitude, measure the amplitude (includesync) at which the Pin20 output is clipped, that is "DR _Y ".
V5	Y Input Pedestal Clamp Voltage / V _{YCLP}	RGB Mute:0 R cut off:63 DC rest.:10 Others:Preset	(1)Input a composite sync signal into Pin38. (2)Connect Pin39 to GND via a 1uF capacitor. (3)Measure the DC Voltage at Pin39, that is "V _{YCLP} ".
V6	Y Frequency Response / FR _Y	RGB Mute:0 R cut off:63 DC rest.:10 Uni-Color:127 Sharpness:Adjust Color:0 Others:Preset	(1)Input a 0.5Vp-p sweep signal with sync into Pin38&39. (2)Adjust Sharpness so that the output amplitude for FSHP equals V _{SH100k} . (3)Measure the frequency at which the output amplitude is 3dB down against V _{SH100k} , which is "FR _Y ".
V7	Y Delay Time / t _{YDEL} / •t _{YDEL-40} / •t _{YDEL+240} / •t _{YDEL}	Uni-Color:127 Color:0 Y DL:000/001/111 RGB Mute:0 R cut off:63 DC rest.:10 Others:Preset	(1)Input a 2T pulse with sync into Pin38&39. (2)Set the BUS data so that Y DL is 0ns(001).Observe the Pin20 output, measure the delay time between Pin39 and Pin20, that is "t _{YDEL} ". (3)Set the BUS data so that Y DL is -40ns(000). Observe the Pin20 output, measure the delay time between Pin39 and Pin20, that is t _{YDEL-40} . (4) Set the BUS data so that Y DL is +240ns(111). Observe the Pin20 output, measure the delay time between Pin39 and Pin20, that is t _{YDEL+240} . (5)Calculate, "•t _{YDEL-40} "= t _{YDEL-40} - "t _{YDEL} " "•t _{YDEL+240} "= t _{YDEL+240} - "t _{YDEL} " "•t _{YDEL} "= ("•t _{YDEL+240} "- "•t _{YDEL-40} ")/7
V8	Brightness Characteristics / V _{BRTMAX} / V _{BRTCEN} / V _{BRTMIN} Brightness Data Sensitivity / •V _{BRT}	Brightness:0/64/127 Color:0 RGB Mute:0 R cut off:63 DC rest.:10 Others:Preset	(1)Input a 0IRE black signal with sync into Pin38&39. (2)Measure the DC level of picture period at Pin20 for Brightness:127/64/0, that is "V _{BRTMAX} " / "V _{BRTCEN} " / "V _{BRTMIN} ". (3)Calculate;"•V _{BRT} "=(V _{BRTMAX} -V _{BRTMIN})/127

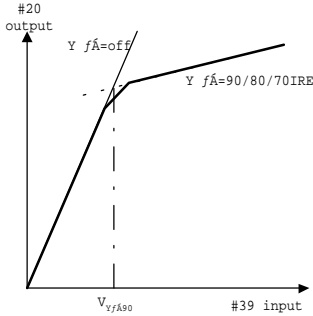
Note	Items/Symbols	Bus conditoinis	Measurement methods
V9	Uni-Color Characteristics for Y / G _{UCYMAX} / G _{UCYCEN} / G _{UCYMIN}	Uni-Color:0/64/127 Color:0 RGB Mute:0 R cut off:63 DC rest.:10 Others:Preset	(1)Input a 50IRE white signal with sync into Pin38&39. (2)Measure the output picture amplitude at Pin20 for Uni-Color:127/64/0, that is V _{UCYMAX} / V _{UCYCEN} / V _{UCYMIN} . (3)Calculate; "G _{UCYMAX} "=20*log(V _{UCYMAX} /0.357) "G _{UCYCEN} "=20*log(V _{UCYCEN} /0.357) "G _{UCYMIN} "=20*log(V _{UCYMIN} /0.357)
V10	Sub-Contrast Characteristics / G _{SCONMAX} / G _{SCONMIN}	Sub-Contrast:0/8/15 Uni-Color:127 Color:0 RGB Mute:0 R cut off:63 DC rest.:10 Others:Preset	(1)Input a 50IRE white signal with sync into Pin38&39. (2)Measure the output picture amplitude at Pin20 for Sub-Contrast 15/8/0, that is V _{SCONMAX} / V _{SCONCEN} / V _{SCONMIN} . (3)Calculate; "G _{SCONMAX} "=20*log(V _{SCONMAX} /V _{SCONCEN}) "G _{SCONMIN} "=20*log(V _{SCONMIN} /V _{SCONCEN})
V11	Sharpness Peaking Frequency / F _{SHP}	Sharpness:63 Uni-Color:127 Color:0 RGB Mute:0 R cut off:63 DC rest.:10 Others:Preset	(1)Input a 0.5Vp-p sweep signal with sync into Pin38&39. (2)Measure the frequency at which the Pin20 output amplitude is Max., that is "F _{SHP} ".
V12	Sharpness Control Characteristics / G _{SHMAX} / G _{SHCEN} / G _{SHMIN}	Sharpness:0/32/63 Uni-Color:127 Color:0 RGB Mute:0 R cut off:63 DC rest.:10 Others:Preset	(1)Input a 0.5Vp-p sweep signal with sync into Pin38&39. (2)Measure the output picture amplitude for 100kHz at Pin20, that is V _{SH100k} . (3)Measure the output picture amplitude for FSHP when Sharpness is max.,center and min., that is V _{SHMAX} , V _{SHCEN} and V _{SHMIN} . (4)Calculate; "G _{SHMAX} "=20*log(V _{SHMAX} /V _{SH100k}) "G _{SHCEN} "=20*log(V _{SHCEN} /V _{SH100k}) "G _{SHMIN} "=20*log(V _{SHMIN} /V _{SH100k})
V13	Y • correction start point / V _{Y, 70} / V _{Y, 80} / V _{Y, 90} Y • correction curve / G _Y	Uni-Color:127 Color:0 RGB Mute:0 R cut off:63 DC rest.:10 • point:01/10/11 Others:Preset	(1)Input a gray raster with sync to Pin38&39. (2)Set BUS data so that • point is 90IRE. (3)Increasing a video amplitude of input from 50IRE, measure a video ampitude as the figure below, that is "V _{Y, 90} " (4)Set BUS data so that • point is 80IRE.And repeat (3), that is "V _{Y, 80} ". (5)Set BUS data so that • point is 70IRE.And repeat (3), that is "V _{Y, 70} ". (6)From the measurement in the above, find gain of the portion that the • correction has an effect on. 

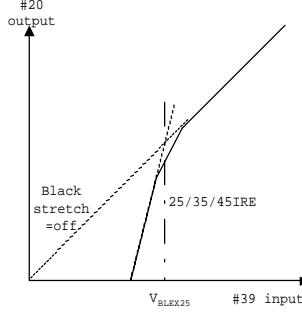
Note	Items/Symbols	Bus conditions	Measurement methods
V14	Black Expansion Start Point / V_{BLEX25} / V_{BLEX35} / V_{BLEX45} Black Expansion AMP Gain / G_{BLEX}	Uni-Color:127 Color:0 Black stretch:00/01 /10/11 RGB Mute:0 R cut off:63 DC rest.:10 Others:Preset	(1)Input a gray raster with sync to Pin38&39. (2)Set black stretch to 25IRE. (3)Decreasing Y amplitude of input from 50IRE, measure a Y amplitude as the figure below, that is " V_{BLEX25} " (4)Set black stretch to 35IRE/45IRE. (5)Repeat (3), that is " V_{BLEX35} ", " V_{BLEX45} ". below, that is " $V_{Y,90}$ " (6)Find gain of the portion that the black stretch has an effect on. 
V16	DC Restratement Gain / $V_{Dcrest120}$ / $V_{Dcrest90}$ / $V_{Dcrest\ step}$	Uni-Color:127 Color:0 Black stretch:00/01 /10/11 RGB Mute:0 R cut off:63 DC rest.:10 Others:Preset	(1)Input a 100IRE signal with sync into Pin38&39. (2)Set DC rest. to 10. (3)Measure a Y amplitude of pin20 output, that is V_{100} . (4)Set DC rest to 00. (5)Measure a Y amplitude of pin20 output, that is V_{120} . (6)Calculate, " $V_{dcrest120} = (V_{120}/V_{100}) \times 100$ " (7)Set DC rest to 11. (8)Repeat (5)&(6), that is " $V_{Dcrest90}$ ". (9)Calculate, " $V_{Dcrest\ step} = (V_{dcrest120} - V_{Dcrest90})/4$ "
V17	WPS Level / V_{WPS}	Uni-Color:127 Brightness:127 Color:0 RGB Mute:0 R cut off:63 DC rest.:10 Others:Preset	(1)Input a 120IRE ramp signal with sync into Pin38&39. (2)Measure the amplitude from cut-off level to peak(at which output signal is clipped), that is " V_{WPS} ".
V18	Chroma Trap Gain / G_{TRAP}	C-Trap:0/1 Uni-Color:127 Color:0 RGB Mute:0 R cut off:63 DC rest.:10 Others:Preset	(1)Input a 0.5Vp-p, 3.58MHz signal with sync into Pin43&39. (2)Measure the 3.58MHz amplitude at Pin20 for Chroma Trap:1/0, that is $V_{TRAPON} / V_{TRAPOFF}$. (3)Calculate; " $G_{TRAP} = 20 \times \log(V_{TRAPON}/V_{TRAPOFF})$ "
V19	Half Tone Characteristics for Y / G_{HTY}	Ysm Mode:0 Uni-Color:127 Color:0 RGB Mute:0 R cut off:63 DC rest.:10 Others:Preset	(1)Input a 100IRE white signal with sync into Pin38&39. (2)Measure the output picture amplitude at Pin20 , that is V_{HTYOFF} . (3)Supply Pin15 2V. (4) Measure the output picture amplitude at Pin20 , that is V_{HTYON} . (3)Calculate; " $G_{HTY} = 20 \times \log(V_{HTYON}/V_{HTYOFF})$ "

CHROMA STAGE (RGB Mute:0 / RGB cut off:63 / DC rest.:10)

Note	Items/Symbols	Bus conditoin	Measurement methods
C1	ACC Characteristics / V_{ACCH} / V_{ACCL}	RGB Mute:0 Y Mute:1 Uni-Color:127 Others:Preset	(1)Input a 4.43MHz PAL rainbow color-bar(300mVp-p, burst:chroma=1:1) with sync into Pin38&43. (2)Changing the amplitude of burst and chroma, measure the input amplitude at which Pin20 output amplitude is +1dB/-1dB against the one for 300mVp-p input, that is " V_{ACCH} "/" V_{ACCL} ".
C2	TOF Characteristics (4.43MHz) / F_{0T443} / Q_{T443} BPF Characteristics (4.43MHz) / F_{0B443} / Q_{B443} TOF Characteristics (3.58MHz) / F_{0T358} / Q_{T358} BPF Characteristics (3.58MHz) / F_{0B358} / Q_{B358}	RGB Mute:0 Y Mute:1 TEST:01000111 C-BPF:0/1 Color System: 010/100 TEST Mode: 00001000 Sub Add."0A": X0011XXX Others:Preset	(1)Set "C-BPF" to 1, "Color System" to 010, "TEST Mode" to 00001000, and Sub address "0A" is X0011XXX. (2)Input a sweep signal into Pin43. (3)Observe the frequency response at Pin13 and measure the Peaking Frequency / Q of chroma filter, that is " F_{0T443} " / " Q_{T443} ". (4)Set C-BPF to 0 and Color System to 010 and repeat (2)&(3), that is " F_{0B443} " / " Q_{B443} ". (5)Set C-BPF to 1 and Color System to 100 and repeat (2)&(3), that is " F_{0T358} " / " Q_{T358} ". (6)Set C-BPF to 0 and Color System to 100 and repeat (2)&(3), that is " F_{0B358} " / " Q_{B358} ".
C3	C Delay Time / t_{CDEL} Delay Time Difference between Y/C / $t_{Y/C}$	RGB Mute:0 Y Mute:1 Uni-Color:127 Others:Preset	(1)Input a 4.43MHz PAL rainbow color-bar(300mVp-p, burst:chroma=1:1) with sync into Pin38&43. (2)Observe the Pin20 output, measure the delay time between Pin43 and Pin20, that is " t_{CDEL} ". (3)Calculate; " $t_{Y/C}$ "= t_{YDEL} - t_{CDEL}
C4	Color Characteristics / G_{COLMAX} / G_{COLMIN}	RGB Mute:0 Color:0/64/127 Y Mute:1 Uni-Color:127 Others:Preset	(1)Input a 4.43MHz PAL rainbow color-bar(300mVp-p, burst:chroma=1:1) with sync into Pin38&43. (2)Measure the Pin20 amplitude for Color 127/64/0, that is V_{COLMAX} / V_{COLCEN} / V_{COLMIN} . (3)Calculate; " G_{COLMAX} "= $20 \cdot \log(V_{COLMAX}/V_{COLCEN})$ " G_{COLMIN} "= $20 \cdot \log(V_{COLMIN}/V_{COLCEN})$
C5	Uni-Color Characteristics for C / G_{UCC}	RGB Mute:0 Uni-Color:0/127 Y Mute:1 Others:Preset	(1)Input a 4.43MHz PAL rainbow color-bar(300mVp-p, burst:chroma=1:1) with sync into Pin38&43. (2)Measure the Pin20 amplitude for Uni-Color 127/0, that is V_{UCCMAX} , and V_{UCCMIN} . (3)Calculate; " G_{UCC} "= $20 \cdot \log(V_{UCCMIN}/V_{UCCMAX})$
C6	Tint Characteristics (3.58MHz) / $\bullet\bullet_{358MAX}$ / $\bullet\bullet_{358MIN}$ Tint Characteristics (4.43MHz) / $\bullet\bullet_{443MAX}$ / $\bullet\bullet_{443MIN}$	RGB Mute:0 Tint:0/64/127 Y Mute:1 Uni-Color:127 Others:Preset	(1)Input a 3.58MHz NTSC rainbow color-bar (286mVp-p, burst:chroma=1:1) with sync into Pin38&43. (2)Set Tint to 64 and adjust the burst phase so that the 6th bar of Pin20 output is maximum, that is \bullet_{358CEN} . (3)Change Tint to 127/0 and adjust the burst phase so that the 6th bar of Pin20 output is maximum, that is \bullet_{358MAX} / \bullet_{358MIN} . (4)Calculate; " $\bullet\bullet_{358MAX}$ "= $-(\bullet_{358MAX}-\bullet_{358CEN})$ " $\bullet\bullet_{358MIN}$ "= $-(\bullet_{358MIN}-\bullet_{358CEN})$ (5)Input a 4.43MHz NTSC rainbow color-bar (286mVp-p, burst:chroma=1:1) with sync into Pin43 and repeat (2)&(3), that is \bullet_{443CEN} / \bullet_{443MAX} / \bullet_{443MIN} . (7)Calculate; " $\bullet\bullet_{443MAX}$ "= $-(\bullet_{443MAX}-\bullet_{443CEN})$ " $\bullet\bullet_{443MIN}$ "= $-(\bullet_{443MIN}-\bullet_{443CEN})$

Note	Items/Symbols	Bus conditoin	Measurement methods
C7	Relative Amplitude (PAL) / $V_{PR/B}$ / $V_{PG/B}$ Relative Amplitude (NTSC1) / $V_{N1R/B}$ / $V_{N1G/B}$ Relative Amplitude (NTSC2) / $V_{N2R/B}$ / $V_{N2G/B}$ Relative Amplitude (DVD) / $V_{DR/B}$ / $V_{DG/B}$	RGB Mute:0 Y Mute:1 Uni-Color:127 Others:Preset	(1)Input a 4.43MHz PAL rainbow color-bar(300mVp-p, burst:chroma=1:1) with sync into Pin38&43. (2)Measure the amplitude of Pin18/19/20 output, that is "VPROUT"/ "VPGOUT" / "VPBOUT" (3)Calculate; " $V_{PR/B}$ "=VPROUT/VPBOUT " $V_{PG/B}$ "=VPGOUT/VPBOUT (4)Input a 3.58MHz NTSC rainbow color-bar (286mVp-p, burst:chroma=1:1) with sync into Pin38&43. (5)Set NTSC Phase to NTSC1/NTSC2. (6)Repeat (2)&(3), that is " $V_{N1R/B}$ "/ " $V_{N1G/B}$ "/ " $V_{N2R/B}$ "/ " $V_{N2G/B}$ ".
C8	Relative Phase (PAL) / \bullet_{PR-B} / \bullet_{PG-B} Relative Phase (NTSC1) / \bullet_{N1R-B} / \bullet_{N1G-B} Relative Phase (NTSC2) / \bullet_{N2R-B} / \bullet_{N2G-B} Relative Phase (DVD) / \bullet_{DR-B} / \bullet_{DG-B}	RGB Mute:0 Y Mute:01 Uni-Color:127 NTSC Phase: 00/01/10 Others:Preset	(1)Input a 4.43MHz PAL rainbow color-bar(300mVp-p, burst:chroma=1:1) with sync into Pin38&43. (2)Observe the Pin18/19/20 output, measure the R/G/B modulation angle ($\bullet_{PR}/\bullet_{PG}/\bullet_{PB}$) accoeding following figure and equality. For \bullet_{PR} ; Peak:3rd bar, $\bullet_{OR}=90$ For \bullet_{PG} ; Peak(negative):4th bar, $\bullet_{OG}=240$ For \bullet_{PB} ; Peak:6th bar, $\bullet_{OB}=0$ Calculate; " \bullet_{PR-B} "= $\bullet_{PR}\cdot\bullet_{PB}$ " \bullet_{PG-B} "= $\bullet_{PG}\cdot\bullet_{PB}$ (4)Set NTSC Phase 00(NTSC1). (5)Input a 3.58MHz NTSC rainbow color-bar (286mVp-p, burst:chroma=1:1) with sync into Pin38&43, then repeat (2), that is $\bullet_{N1R}/\bullet_{N1G}/\bullet_{N1B}$. (6)Calculate; " \bullet_{N1R-B} "= $\bullet_{N1R}\cdot\bullet_{N1B}$ " \bullet_{N1G-B} "= $\bullet_{N1G}\cdot\bullet_{N1B}$ (7)Set NTSC Phase 01(NTSC2). (8) Repeat (5), that is $\bullet_{N2R}/\bullet_{N2G}/\bullet_{N2B}$. (9)Calculate; " \bullet_{N2R-B} "= $\bullet_{N2R}\cdot\bullet_{N2B}$ " \bullet_{N1G-B} "= $\bullet_{N1G}\cdot\bullet_{N1B}$ (10)Set NTSC Phase 10(DVD).
C9	APC Pull-in Range (4.43MHz) / $\bullet_{F4APCP+}$ / $\bullet_{F4APCP-}$ APC Hold Range (4.43MHz) / $\bullet_{F4APCH+}$ / $\bullet_{F4APCH-}$ APC Pull-in Range (3.58MHz) / $\bullet_{F3APCP+}$ / $\bullet_{F3APCP-}$ APC Hold Range (3.58MHz) / $\bullet_{F3APCH+}$ / $\bullet_{F3APCH-}$	RGB Mute:0 Color System: 100/010 Others:Preset	(1)Input a 4.43MHz PAL rainbow color-bar(300mVp-p, burst:chroma=1:1) with sync into Pin38&43. (2)Set Color System to 100(443PAL). (3)For higher frequency than 4.43MHz, measure the burst frequency at which Pin13 DC level changes from low to high / from high to low, that is F_{4APCP+}/F_{4APCH+} . (4)For lower frequency than 4.43MHz, repeat (2), that is F_{4APCP-}/F_{4APCH-} . (5)Calculate; " $\bullet_{F4APCP+}$ "= $F_{4APCP+}-4433619$ " $\bullet_{F4APCP-}$ "= $4433619-F_{4APCP-}$ " $\bullet_{F4APCH+}$ "= $F_{4APCH+}-4433619$ " $\bullet_{F4APCH-}$ "= $4433619-F_{4APCH-}$ (6)Input a 3.58MHz NTSC rainbow color-bar (286mVp-p, burst:chroma=1:1) with sync into Pin38&43. (7)Set Color System to 010(358NTSC). (8)For higher frequency than 3.58MHz, repeat (2), that is F_{3APCP+}/F_{3APCH+} . (9)For lower frequency than 3.58MHz, repeat (2), that is F_{3APCP-}/F_{3APCH-} . (10)Calculate; " $\bullet_{F3APCP+}$ "= $F_{3APCP+}-3579545$ " $\bullet_{F3APCP-}$ "= $3579545-F_{3APCP-}$ " $\bullet_{F3APCH+}$ "= $F_{3APCH+}-3579545$ " $\bullet_{F3APCH-}$ "= $3579545-F_{3APCH-}$

Note	Items/Symbols	Bus conditoin	Measurement methods
C10	APC Control Sensitivity (4.43MHz) / •443 APC Control Sensitivity (3.58MHz) / •358	RGB Mute:0 Color System: 100/010 Others:Preset	(1)Connect Pin43 to GND via a 1uF capacitor. (2)Set Color System to 100(443PAL). (3)Adjust Pin11 voltage so that the Pin13 output frequency is 4.433619MHz, that is $V_{4APCCEN}$. (4)Measure the Pin13 output frequency when Pin11 voltage is $V_{4APCCEN}+100mV / V_{4APCCEN}-100mV$, that is F_{4APC+} / F_{4APC-} . (5)Calculate; "•443"= $(F_{4APC+}-F_{4APC-})/200$ (6)Set Color System to 010(358NTSC). (7)Adjust Pin11 voltage so that the Pin13 output frequency is 3.579545MHz, that is $V_{3APCCEN}$. (8)Measure the Pin13 output frequency when Pin11 voltage is $V_{3APCCEN}+100mV / V_{3APCCEN}-100mV$, that is F_{3APC+} / F_{3APC-} . (9)Calculate; "•358"= $(F_{3APC+}-F_{3APC-})/200$
C11	PAL ID Sensitivity (Normal Mode) / $V_{PALIDON}$ / $V_{PALIDOFF}$ PAL ID Sensitivity (Low Mode) / $V_{PALIDLON}$ / $V_{PALIDLOFF}$ NTSC ID Sensitivity (Normal Mode) / V_{NTIDON} / $V_{NTIDOFF}$ NTSC ID Sensitivity (Low Mode) / $V_{NTIDLON}$ / $V_{NTIDLOFF}$	P/N ID Sens:0/1 Color System: 100/010 Y Mute:01 Uni-Color:127 RGB Mute:0 Others:Preset	(1)Set P/N ID Sens. to 0. (2)Set Color System to 100(443PAL). (3)Input a 4.43MHz PAL rainbow color-bar(300mVp-p, burst:chroma=1:1) with sync into Pin38&43. (4)Measure the burst amplitude at which Pin13 DC level changes from low to high / from high to low, that is " $V_{PALIDON}$ " / " $V_{PALIDOFF}$ ". (5)Set Color System to 010(358NTSC). (6)Input a 3.58MHz NTSC rainbow color-bar (286mVp-p, burst:chroma=1:1) with sync into Pin38&43, and repeat (3), that is " V_{NTIDON} " / " $V_{NTIDOFF}$ ". (7)Set P/N ID Sens.to 1, repeat (2) ~ (6), that is " $V_{PALIDLON}$ " , " $V_{PALIDLOFF}$ " , " $V_{NTIDLON}$ " and " $V_{NTIDLOFF}$ ".
C12	fsc Continuous Wave Output Level / V_{CW}	RGB Mute:00 Others:Preset	Measure the amplitude of Pin20 output, that is " V_{CW} ".
C13	Half Tone Characteristics for C / G_{HTC}	RGB Mute:0 Ysm Mode:0 Y Mute:01 Uni-Color:127 Others:Preset	(1)Input a 4.43MHz PAL rainbow color-bar(300mVp-p, burst:chroma=1:1) with sync into Pin38&43. (2)Supply Pin15 2V and measure the amplitude of Pin20 output, that is V_{PBHTC} . (3)Calculate;" G_{HTC} "= $20 \cdot \log(V_{PBHTC} / V_{PBOUT})$
C14	Sub-Color Control Characteristics / •SCOLMAX / •SCOLMIN	RGB Mute:00 Y Mute:01 Uni-Color:127 Sub-Color:0 /16/32 Others:Preset	1)Input a signal($f_0=100kHz, 300mV$) of following figure into Pin38,44&45. (2)Measure the Pin20 amplitude for Sub-olor 32/16/0, that is $V_{SCMAX} / V_{SCLCEN} / V_{SCMIN}$. (3)Calculate; "•SCOLMAX "= $20 \cdot \log(V_{SCMAX} / V_{SCLCEN})$ "•SCOLMIN "= $20 \cdot \log(V_{SCMIN} / V_{SCLCEN})$

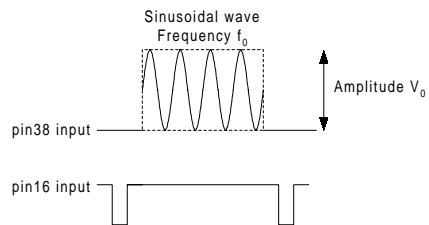

SECAM STAGE

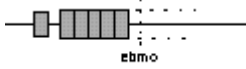
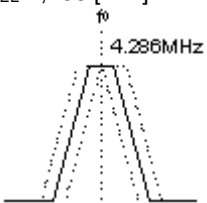
Note	Items/Symbols	Bus conditoins	Measurement methods
SE1	Bell Monitor output voltage / embo	RGB Mute:0 TEST Mode: 00001000 Sub Add."1A": X0111XXX Others:Preset	(1) Input a 75% color bar signal (200mVp-p at R ID) into Pin43. (2) Set BUS data so that " (3) TEST Mode" is 00001000 and Sub address "0A" is X0111XXX. (3) Measure R-Y ID amplitude at Pin13, that is "ebmo". 
SE2	Bell filter f0 / f0B-C	RGB Mute:00 TEST Mode: 00001000 Sub Add."0A": X0111XXX Bell f0:0 Y Mute:1 Others:Preset	(1) Input a 20mVp-p sine wave whose frequency is sweep into Pin43. (2) Set BUS data so that "TEST Mode" is 00001000 and Sub address "0A" is X0111XXX. (3) Measure the frequency at which Pin13 output is the biggest, that is "f0BEL". (4) Calculate : "f0B-C"=f0BEL-4,286 [kHz]. 
SE3	Bell filter f0 variable range / f0B-VR	RGB Mute:00 TEST Mode: 00001000 Sub Add."0A": X0111XXX Bell f0:1 Y Mute:1 Others:Preset	(1) Input a 20mVp-p sine wave whose frequency is sweep into Pin43. (2) Set BUS data so that "TEST Mode" is 00001000 and Sub address "0A" is X0111XXX. (3) Set BUS data so that "Bell f0" is +35kHz. (4) Measure the frequency at which Pin 13 output is the biggest, that is f0BELH. (5) Calculate : " f0B-VR " = f0BELH -4,286 [kHz]
SE4	Bell filter Q / QBEL	RGB Mute:00 TEST Mode: 00001000 Sub Add."0A": X0111XXX Y Mute:1 Others:Preset	(1) Input a 20mVp-p sine wave whose frequency is sweep into Pin43. (2) Set BUS data so that "TEST Mode" is 00001000 and Sub address "0A" is X0111XXX. (4) Observe the frequency response of Pin13 output. (5) Calculate : "QBEL = (MAX-3dB Band Width)/f0BEL.
SE5	Color difference output amplitude / VBS / VRS	RGB Mute:00 Uni-Color:63 Y Mute:1 Others:preset	(1) Input a 75% color bar(200mVp-p at R ID) into Pin43. (2) Measure the R-Y output amplitude at Pin20, that is "VRS". (3) Measure the B-Y output amplitude at Pin22, that is "VBS".
SE6	Color Difference Relative Amplitude / R/B-S		(1) Calculate : "R/B-S"=VRS/VBS
SE8	Color Difference S/N Ratio / SNB-S / SBR-S	RGB Mute:00 Uni-Color:63 Y Mute:1 Others:preset	(1) Input a 200mVp-p non-modulated chroma signal into Pin43. (2) Measure the amplitude of noise on Pin20, that is nR. (3) Measure the amplitude of noise on Pin22, that is nB. (4) Calculate : "SNB-S"=20log(2•2VBS/nB) "SNR-S"=20log(2•2VRS/nR)

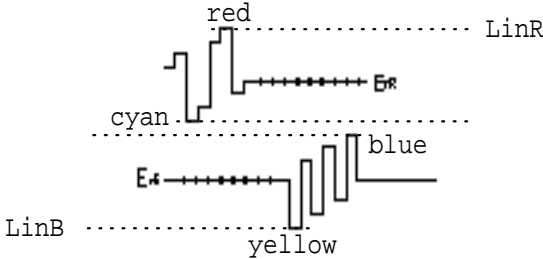
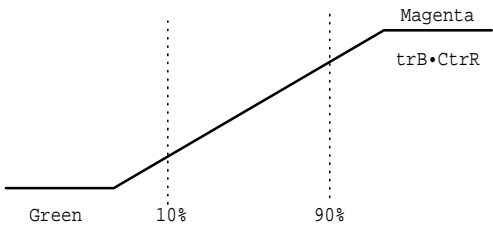
Note	Items/Symbols	Bus conditoins	Measurement methods
SE9	Linearity / LinB / LinR	RGB Mute:00 Uni-Color:63 Y Mute:1 Others:preset	(1) Input a 75% color bar(200mVp-p at R ID) into Pin43. (2) Set BUS data so that "S black monitor" is "alignment". (2) Measure the amplitude between Black and Cyan/Red, that is VCyan/VRed. (3) Measure the amplitude between Black and Yellow/Blue, that is VYellow/VBlue. (4) Calculate : "LinR"=VCync/VRed "LinB"=VYellow/VBlue 
SE10	Rising-Fall Time / trfB / trfR	RGB Mute:00 Uni-Color:63 Y Mute:1 Others:preset	(1) Input a 75% color bar(200mVp-p at R ID) into Pin43. (2) Set BUS data so that "S black monitor" is "alignment". (3) Measure the rising time(from 10% to 90%) between Green and Magenta at Pin 20/Pin 22, that is "trR"/"trB". 
SE11	SECAM ID Sensitivity (Normal Mode) / VSIDHON / VSIDHOFF / VSIDHVON / VSIDHVOFF SECAM ID Sensitivity (Low Mode) / VSIDLHON / VSIDLHOFF / VSIDLHVON / VSIDLHVOFF	RGB Mute:00 Y Mute:1 S ID Sens:0/1 S ID Mode:0/1 Color System:101 Others:Preset	(1) Input a 75% color bar(200mVp-p at R ID) into Pin43. (2) Set BUS data so that "S ID Sens" is Normal, "S ID Mode" is H. (3) Measure the burst amplitude at which Pin13 DC level changes from low to high / from high to low, that is "VSIDHON" / "VSIDHOFF". (4) Set BUS data so that "S ID Mode" is H+V. (5) Repeat (3), that is "VSIDHVON" / "VSIDHVOFF". (6) Set BUS data so that "S ID Sens" is Low, "S ID Mode" is H. (7) Repeat (3), that is "VSIDLHON" / "VSIDLHOFF". (8) Set BUS data so that "S ID Mode" is H+V. (9) Repeat (3), that is "VSIDLHVON" / "VSIDLHVOFF".
SE12	Gate Pulse Width Variable Range / WGP+200 / WGP / WGP-200	RGB Mute:00 TEST Mode: 00001000 Sub Add."0A": X1001XXX Color System:101 Others:Preset	(1) Input a 75% color bar(200mVp-p at R ID) into Pin43. (2) Set BUS data so that "TEST Mode" is 00001000, Sub address "0A" is X1001XXX, and "Color System" is Fixed SECAM. (3) Measure the gate pulse widths when BUS data of "SECAM GP Phase" is +200ns / normal / -200ns, those are "WGP+200", "WGP" and "WGP-200".
S13	SECAM black adjustment characteristic / VSBMAX / VSRMAX / VSRMIN / VSRMIN SECAM black adjustment sensitivity / VSB / VSR	RGB Mute:00 Color System:101 S black Monitor:1 S B-Y black Adj.: 0/15 S R-Y black Adj.: 0/15 Others:Preset	(1) For B-Y/R-Y Black Adj.:8, measure the DC level of picture period at Pin22/20, that is VSBCEN / VSRCEN. (3) For B-Y Black Adj.:0/15, measure the DC level change of picture period against VSBCEN at Pin22, that is "VSBMIN" / "VSBMAX". (4) For R-Y Black Adj.:0/15, measure the DC level change of picture period against VSRCEN at Pin20, that is "VSRMIN" / "VSRMAX". (5) Calculate; "•VSECB"=(VSBMAX-VSBMIN)/16 "•VSECR"=(VSECRMAX-VSECRMIN)/16

TEXT STAGE(RGB Mute:0 / RGB cut off:63 / DC rest.:10)

Note	Items/Symbols	Bus conditoins	Measurement methods
T1	V-BLK Pulse Output Level / V_{VBLK} H-BLK Pulse Output Level / V_{HBLK}	All: Preset	(1) Input a composite sync signal into Pin38. (2) Measure the DC level of V/H blanking period at Pin20, that is " V_{VBLK} " / " V_{HBLK} ".
T2	RGB Output Black Level (0IRE DC) / V_{BLACK}	RGB Mute:0 Color:0 R cut off:63 DC rest.:10 Others: Preset	(1) Input a 0IRE Y signal with sync into Pin38&39. (2) Measure the DC level of picture period at Pin20, that is " V_{BLACK} ".
T3	RGB Output White Level(100 IRE AC) / V_{WHITE}	RGB Mute:0 R cut off:63 DC rest.:10 Uni-Color:127 Color:0 Others: Preset	(1) Input a 100IRE Y signal with sync into Pin38&39. (2) Measure the amplitude from 0 to 100IRE at Pin20, that is " V_{WHITE} ".
T4	Cut-off Voltage Variable Range / $\bullet V_{CUT+}$ / $\bullet V_{CUT-}$	RGB Mute:0 DC rest.:10 B Cut Off:0/255 Color:0 Others: Preset	(1) Input a 0IRE Y signal with sync into Pin38&39. (2) Measure the DC level of picture period at Pin22 for B Cut-off:255/0, that is V_{CUTMAX} / V_{CUTMIN} . (3) Calculate; " $\bullet V_{CUT+}$ "= $V_{CUTMAX}-V_{BLACK}$ " $\bullet V_{CUT-}$ "= $V_{CUTMIN}-V_{BLACK}$
T5	Drive Control Variable Range / G_{DR+} / G_{DR-}	RGB Mute:0 DC rest.:10 B Drive:0/127 Uni-Color:127 Color:0 Others: Preset	(1) Input a 100IRE Y signal with sync into Pin38&39. (2) Measure the amplitude from 0 to 100IRE at Pin20 for B drive127/0, that is V_{DRMAX} / V_{DRMIN} . (1) Calculate; " G_{DR+} "= $20 \cdot \log(V_{DRMAX}/V_{WHITE})$ " G_{DR-} "= $20 \cdot \log(V_{DRMIN}/V_{WHITE})$
T6	ABCL Contorol Voltage Range / V_{ABCLH} / V_{ABCLL} ACL Gain / G_{ACL}	RGB Mute:0 R cut off:63 DC rest.:10 ABL Gain:11 Uni-Color:127 Color:0 Others: Preset	(1) Input a 100IRE Y signal with sync into Pin38&39. (2) Decreasing the Pin28 voltage, measure the voltage at which Pin20 output begins/stops decreasing, that is " V_{ABCLH} " / " V_{ABCLL} ". (3) Measure the minimum amplitude of Pin20 output, that is V_{ACLMIN} . (4) Calculate; " G_{ACL} "= $20 \cdot \log(V_{ACLMIN}/V_{WHITE})$
T7	ABL Start Point / V_{ABLP0} / V_{ABLP1} / V_{ABLP2} / V_{ABLP3}	RGB Mute:0 R cut off:63 DC rest.:10 ABL Start Point: 00/01/10/11 ABL Gain:11 Uni-Color:127 Color:0 Others: Preset	(1) Input a 0IRE Y signal with sync into Pin38&39. (2) For ABL Point 00/01/10/11, decreasing the Pin28 voltage, measure the voltage at which Pin20 output begins decreasing, that is $V_{ABL1}/V_{ABL2}/V_{ABL3}/V_{ABL4}$. (3) Calculate; " V_{ABLP0} "= $V_{ABL1}-V_{ABCLH}$ " V_{ABLP1} "= $V_{ABL2}-V_{ABCLH}$ " V_{ABLP2} "= $V_{ABL3}-V_{ABCLH}$ " V_{ABLP3} "= $V_{ABL4}-V_{ABCLH}$
T8	ABL Gain / V_{ABLG0} / V_{ABLG1} / V_{ABLG2} / V_{ABLG3}	RGB Mute:0 R cut off:63 DC rest.:10 ABL Gain: 00/01/10/11 Uni-Color:127 Color:0 Others: Preset	(1) Input a 0IRE Y signal with sync into Pin38&39. (2) For ABL Gain 00/01/10/11, measure the DC level of picture period at Pin20 when Pin28 voltage is V_{ABCLL} , that is $V_{ABL5}/V_{ABL6}/V_{ABL7}/V_{ABL8}$. (3) Calculate; " V_{ABLG0} "= $V_{ABL5}-V_{BLACK}$ " V_{ABLG1} "= $V_{ABL6}-V_{BLACK}$ " V_{ABLG2} "= $V_{ABL7}-V_{BLACK}$ " V_{ABLG3} "= $V_{ABL8}-V_{BLACK}$

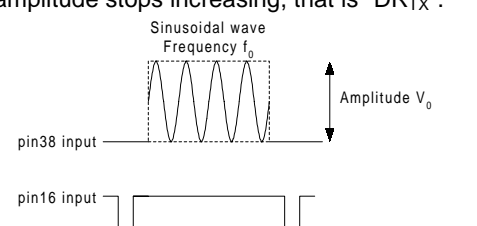
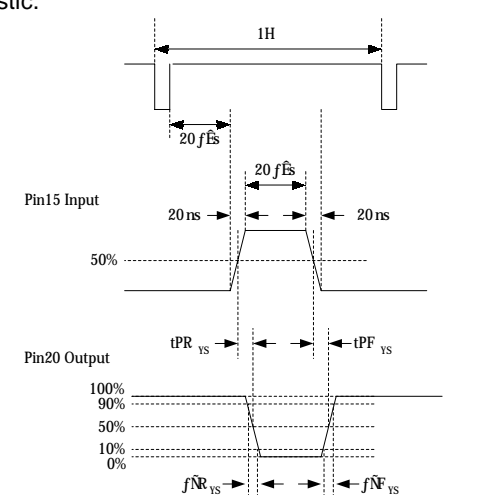
Note	Items/Symbols	Bus conditioins	Measurement methods
T9	Analog RGB Dynamic Range / DR _{TX}	RGB Mute:0 R cut off:63 DC rest.:10 RGB Contrast:32 Ysm Mode:1 Others:Preset	(1)Input a composite sync signal into Pin38. (2)Supply 2V to Pin15. (3)Input a signal of following figure into Pin16. (4)Increasing the amplitude of Pin16 input, measure the amplitude at which the Pin20 amplitude stops increasing, that is "DR _{TX} ". 
T10	Analog RGB Contrast Control Characteristic / G _{TXCMAX} / G _{TXCCEN} / G _{TXCMIN}	RGB Mute:0 R cut off:63 DC rest.:10 Ysm Mode:1 RGB Contrast:0/32/63 Others:Preset	(1)Input a composite sync signal into Pin38. (2)Supply 2V to Pin15. (3)Input a signal of NOTE:T9 figure(f ₀ =100kHz,V ₀ =0.2Vp-p) into Pin16. (4)For RGB Contrast 63/32/0, measure the amplitude of Pin20 output, that is V _{TXCMAX} / V _{TXCCEN} / V _{TXCMIN} . (5)Calculate; "G _{TXCMAX} "=20*log(V _{TXCMAX} /0.2) "G _{TXCCEN} "=20*log(V _{TXCCEN} /0.2) "G _{TXCMIN} "=20*log(V _{TXCMIN} /0.2)
T11	Analog RGB Brightness Control Characteristic / V _{TXBRMAX} / V _{TXBRCEN} / V _{TXBRMIN}	RGB Mute:0 R cut off:63 DC rest.:10 Ysm Mode:1 Brightness:0/64/127 Others:Preset	(1)Supply 2V to Pin15. (2)Connect Pin16 to GND via a 0.1uF capacitor. (3)For Brightness 127/64/0, measure the DC level of picture period at Pin20, that is "V _{TXBRMAX} " / "V _{TXBRCEN} " / "V _{TXBRMIN} ".
T12	Analog RGB Mode Switching Level / V _{YS}	RGB Mute:0 Ysm Mode:1 RGB Contrast:32 Others:Preset	(1)Input a composite sync signal into Pin38. (2)Input a signal of NOTE:T9 figure into Pin16. (3)Increasing the Pin15 voltage, measure the voltage at which the signal inputted into Pin16 appears at Pin20, that is "V _{YS} ".
T13	Analog RGB Mode Transfer Characteristic / •R _{YS} / tPR _{YS} / •F _{YS} / tPF _{YS}	RGB Mute:0 R cut off:63 DC rest.:10 Ysm Mode:1 Others:Preset	(1)Input a 50IRE Y signal with sync into Pin38&39. (2)Connect Pin16 to GND via a 0.1uF capacitor. (3)According to following figure, measure the Analog RGB Mode Transfer Characteristic. 

Note	Items/Symbols	Bus conditoins	Measurement methods
T14	Cross Talk from Analog RGB to TV / CT _{TX-TV}	RGB Mute:0 R cut off:63 DC rest.:10 Ysm Mode:1 Uni-color:127 RGB contrast:63 Others:Preset	(1) Input a composite sync signal into Pin38. (2) Connect Pin39 to GND via a 1uF capacitor. (3) Input a sine wave signal (f=4MHz, Video amplitude=0.5Vp-p) into Pin16. (4) Supply 0V to Pin15. (5) Measure the amplitude at Pin20, that is V _{TV} . (6) Supply 2V to Pin15. (7) Measure the amplitude of 4MHz signal at Pin20, that is V _{TX} . (8) Calculate; "CT _{TX-TV} "=20*log(V _{TV} / V _{TX})
T15	Cross Talk from TV to Analog RGB / CT _{TV-TX}	RGB Mute:0 R cut off:63 DC rest.:10 Ysm Mode:1 Uni-color:127 RGB contrast:63 Others:Preset	(1) Input a sine wave signal (f=4MHz, Video amplitude=0.5Vp-p) with sync into Pin38&39. (2) Connect Pin16 to GND via a 0.1uF capacitor. (3) Supply 2V to Pin15. (4) Measure the amplitude at Pin20, that is V _{TX} . (5) Supply 0V to Pin15. (6) Measure the amplitude of 4MHz signal at Pin20, that is V _{TV} . (7) Calculate; "CT _{TV-TX} "=20*log(V _{TX} / V _{TV})
T16	SECAM Black Level Adj. Characteristics / V _{SECBMAX} / V _{SECBMIN} / V _{SECBMIN} / V _{SECBMIN} SECAM Black Level Adj. Data Sensitivity / •V _{SECB} / •V _{SECB}	RGB Mute:0 R cut off:63 DC rest.:10 Color System:111 B-Y Black Adj: 0/8/15 R-Y Black Adj: 0/8/15 S black monitor:1 Others:Preset	(1) Set S black monitor to 1. (2) For B-Y/R-Y Black Adj.:8, measure the DC level of picture period at Pin22/20, that is V _{SECBCE} / V _{SECBCE} . (3) For B-Y Black Adj.:0/15, measure the DC level change of picture period against V _{SECBCE} at Pin22, that is "V _{SECBMIN} " / "V _{SECBMAX} ". (4) For R-Y Black Adj.:0/15, measure the DC level change of picture period against V _{SECBCE} at Pin20, that is "V _{SECBMIN} " / "V _{SECBMAX} ". (5) Calculate; "•V _{SECB} "=(V _{SECBMAX} -V _{SECBMIN})/16 "•V _{SECB} "=(V _{SECBMAX} -V _{SECBMIN})/16
T17	Base band TINT characteristic / ••BBMAX / ••BBMIN	RGB Mute:0 R cut off:63 DC rest.:10 Uni-color:127 Others:Preset	(1) Input a signal(f0=100kHz, 100mVp-p) of NOTE T9 into Pin44&38. (2) Into Pin45, into a signal with the same amplitude but 90deg phase advanced compared to the signal input to pin44. (3) When baseband TINT is changed '10000' to'00000', measure the amount of change in the output phase of Pin20, that is "••BBMIN". (4) When baseband TINT is changed '10000' to'11111', measure the amount of change in the output phase of Pin20, that is "••BBMIN".
T18	Analog RGB•RGB Output Voltage Axes Difference ••V _{R-G} ••V _{G-B} ••V _{B-R}	RGB Mute:0 R/G/B cut off:63 Brightness:63 DC rest.:10 Color:0 Uni-color:127 Others:Preset	(1) Input a 0IRE signal with sync into Pin38&39. (2) Connect Pin16,17,18 to GND via 0.01•F. (3) Measure the DC level of picture period at Pin20,21,22, that is R _T /G _T /B _T . (4) Supply Pin15 to 2V. (5) Measure the DC level of picture period at Pin20,21,22, that is R _T /G _T /B _T . (6) Calculate; •R • R _T • R _Y •G • G _T • G _Y •B • B _T • B _Y "•V _{R-G} " • •R • •G "•V _{G-B} " • •G • •B "•V _{B-R} " • •B • •R

DEF STAGE

Note	Items/Symbols	Bus conditoins	Measurement methods
D1	AFC Inactive Period / T _{50AFCOFF} / T _{60AFCOFF}	All:Preset	(1) Input a 50Hz/60Hz composite sync signal into Pin38. (2) Measure "T _{50AFCOFF} " / "T _{60AFCOFF} " at Pin29. (cf. Fig.D1)

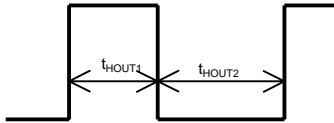
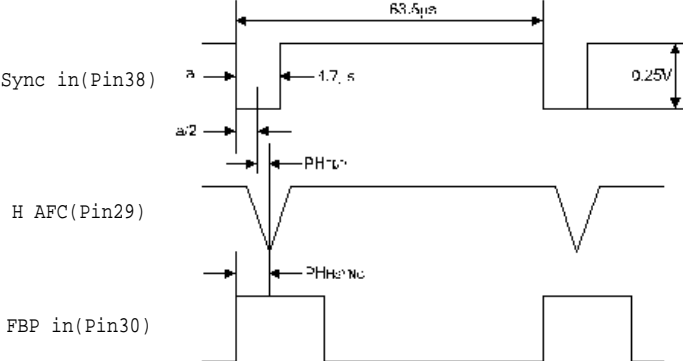
Note	Items/Symbols	Bus conditoins	Measurement methods
D2	H-OUT Start Voltage / V_{HON}	All:Preset	(1)Let Pin1/14/37/42 be open. (2)Increasing Pin31 voltage, measure the voltage at which H OUT pulse appears at Pin32, that is " V_{HON} ".
D3	H-OUT Pulse Duty / W_{HOUT}	All:Preset	(1)Measure t_{HOUT1} & t_{HOUT2} at Pin32. (2)Calculate; " W_{HOUT} "= $t_{HOUT1}/(t_{HOUT1}+t_{HOUT2}) * 100$ 
D4	H-OUT Freq. on AFC Stop Mode / $F_{HAFCOFF}$	AFC Gain:11 (OFF) Others:Preset	(1)Input a 50Hz composite sync signal into Pin38. (2)Measure the H OUT frequency at Pin32, that is " $F_{HAFCOFF}$ ".
D5	Horizontal Free-run Frequency / F_{H50FR} / F_{H60FR}	V-Freq:001/010 Others:Preset	For V-Freq 001/010, measure the H OUT frequency at Pin32, that is " F_{H50FR} " / " F_{H60FR} ".
D6	Horizontal Freq. Variable Range / F_{HMAX} / F_{HMIN}	All:Preset	(1)Connect Pin29 to Vcc via a 10k Ω and measure the H OUT frequency at Pin32, that is " F_{HMAX} ". (2)Connect Pin29 to GND via a 68k Ω and measure the H OUT frequency at Pin32, that is " F_{HMIN} ".
D7	Horizontal Freq. Control Sensitivity / \bullet_{HAFC}	All:Preset	(1)Measure the Pin29 voltage at which H OUT frequency is 15.734kHz, that is V_{H15734} . (2)Measure the H OUT frequency when Pin29 voltage is $V_{H15734} + 50mV$ / $V_{H15734} - 50mV$, that is F_{HHIGH} / F_{HLOW} . (3)Calculate; " \bullet_{HAFC} "= $(F_{HHIGH}-F_{HLOW})/100$
D8	Horizontal Pull-in Range / \bullet_{FHPH} / \bullet_{FHPL}	All:Preset	(1)Input a composite sync signal into Pin38. (2)Decreasing the horizontal frequency from 17kHz, measure the frequency at which H OUT synchronized with SCP Out(Pin29), that is F_{HPH} . (3)Increasing the horizontal frequency from 14kHz, measure the frequency at which H OUT synchronized with SCP Out(Pin29), that is F_{HPL} . (4)Calculate; " \bullet_{FHPH} "= $F_{HPH}-15734$ " \bullet_{FHPL} "= $15625-F_{HPL}$
D9	H-OUT Voltage / V_{HOUTH} / V_{HOUTL}	All:Preset	(1)Measure the high level of H OUT at Pin32, that is " V_{HOUTH} ". (2)Measure the low level of H OUT at Pin32, that is " V_{HOUTL} ".
D10	Horizontal Freq. Dependence on Vcc / \bullet_{FHVCC}	All:Preset	(1)Measure the H OUT frequency when H Vcc(Pin31) is 8.5V/9.5V, that is F_{HVCCH} / F_{HVCLL} . (2)Calculate; " \bullet_{FHVCC} "= $(F_{HVCCH}-F_{HVCLL})/1$
D11	FBP Phase / PH_{FBP} H-Sync. Phase / PH_{HSYNC}	All:Preset	(1)Input a composite sync signal into Pin38. (2)According to the following figure, measure " PH_{FBP} " & " PH_{HSYNC} ". 

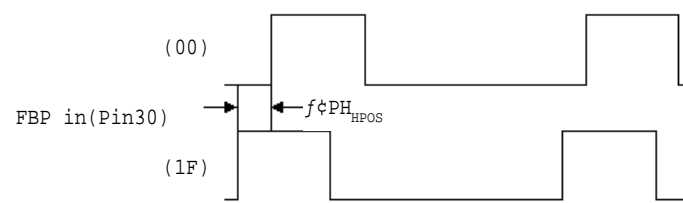
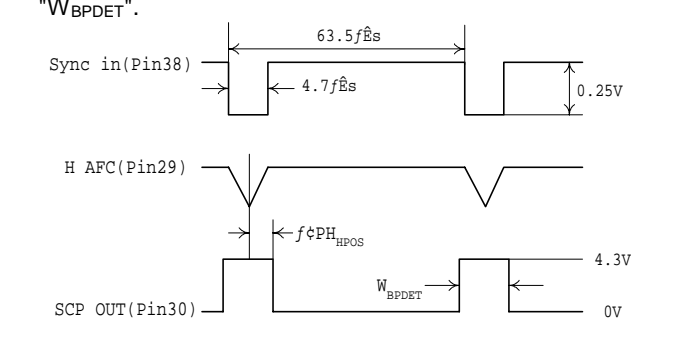
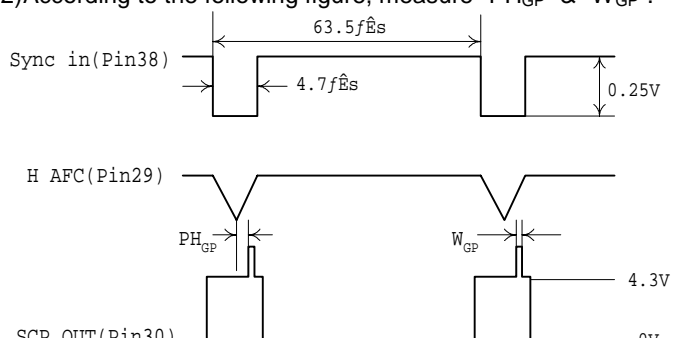
Note	Items/Symbols	Bus conditoins	Measurement methods
D12	Horizontal Position Variable Range / •PH _{HPOS}	H Position:0/31 Others:Preset	(1)Input a composite sync signal into Pin38. (2)Changing BUS data of "Horizontal Position" from 0 to 31, measure "•PH _{HPOS} " according to the following figure. 
D13	AFC-2 Pulse Threshold Level / V _{AFC2}	All:Preset	(1)Input a composite sync signal into Pin38. (2)Decreasing the FBP high level, measure the DC level at which H OUT phase changes against Sync Out phase, that is "V _{AFC2} ".
D14	H-BLK Pulse Threshold Level / V _{HBLK}	All:Preset	(1)Input a composite sync signal into Pin38. (2)Increasing the FBP high level, measure the DC level at which H blanking begins to work, that is "V _{HBLK} ".
D15	Black Peak Det. Stop Period (H) / PH _{BPDET} / W _{BPDET}	TEST:0001000 Black Stretch:01 Others:Preset	(1) Input a composite sync signal into Pin38. (2) According to the following figure, measure "PH _{BPDET} " & "W _{BPDET} ". 
D16	Gate Pulse Start Phase / PH _{GP} Gate Pulse Width / W _{GP}	All:Preset	(1)Input a composite sync signal into Pin38. (2)According to the following figure, measure "PH _{GP} " & "W _{GP} ". 
D17	Vertical Oscillation Start Voltage / V _{VON}	All:Preset	(1)Let Pin1/14/37/42 be open. (2)Increasing Pin31 voltage, measure the voltage at which V Ramp signal (3)appears at Pin24, that is "V _{VON} ".
D18	Vertical Free-run Frequency / F _{VAUFR50} / F _{VAUFR60} / F _{V50FR} / F _{V60FR}	V-Freq: 000/001/010 Others:Preset	(1)Input a 50Hz composite sync signal into Pin38. (2)Set V-Freq to 000. (3)For no input, measure the frequency of V Ramp at Pin22, that is "F _{VAUFR50} ". (3) Input a 60Hz composite sync signal into Pin38. (4) Repeat (2)&(3), that is "F _{VAUFR60} " (5) Set V-Freq. To 001/101, repeat (2), that is "F _{V50FR} " / "F _{V60FR} ".
D19	Gate Pulse V-Masking Period / T _{50GPM} / T _{60GPM}	All:Preset	(1)Input a 50Hz/60Hz composite sync signal into Pin38. (2)Measure "T _{50GPM} " / "T _{60GPM} " at Pin30. (cf. Fig.D21)

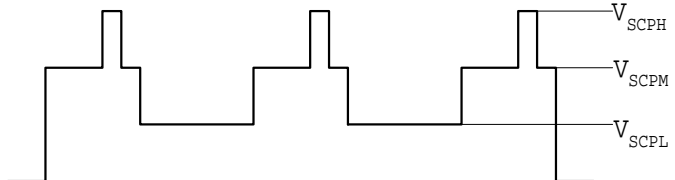
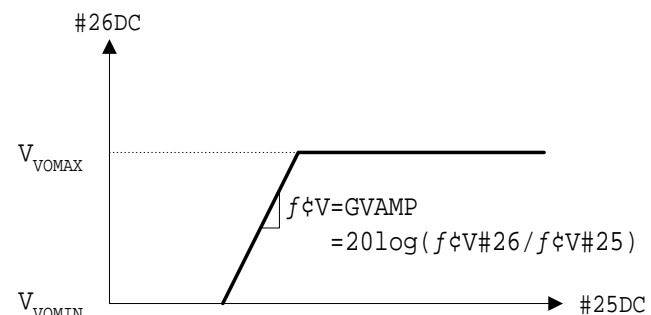
Note	Items/Symbols	Bus conditoins	Measurement methods
D20	V. Ramp DC on Service Mode / $V_{NOVRAMP}$	V STOP:1 Others:Preset	(1)Set V STOP to 1. (2)Measure the DC level of Pin24, that is " $V_{NOVRAMP}$ ".
D21	Vertical Pull-in Range (Auto) / F_{VPAUL} / F_{VPAUH} Vertical Pull-in Range (50Hz) / F_{VP50L} / F_{VP50H} Vertical Pull-in Range (60Hz) / F_{VP60L} / F_{VP60H}	V-Freq: 000/001/010 Others:Preset	(6) Input a composite sync signal into Pin38. (7) For V-Freq 000/001/010, increasing the input vertical period from 220H by 0.5H step, measure the period at which input signal synchronized with V Ramp(Pin24), that is " F_{VPAUL} " / " F_{VP50L} " / " F_{VP60L} ". (8) (3)For V-Freq 000/001/010, decreasing the input vertical period from 360H by 0.5H step, measure the period at which input signal synchronized with V Ramp, that is " F_{VPAUH} " / " F_{VP50H} " / " F_{VP60H} ".
D22	Vertical Period on Fixed Mode / T_{V3125} / T_{V2625} / T_{V313} / T_{V263}	V-Freq: 100/101/110/ 111 Others:Preset	For V-Freq 100/101/110/111, measure the vertical period at SCP out (Pin30), that is " $T_{V312.5}$ " / " $T_{V262.5}$ " / " T_{V313} " / " T_{V263} ".
D23	V-BLK Start Phase / PH_{50VBLK} / PH_{60VBLK} V-BLK Width / W_{50VBLK} / W_{60VBLK}	All:Preset	(1)Input a 50Hz/60Hz composite sync signal into Pin38. (2)Measure " $T_{50AFCOFF}$ " / " $T_{60AFCOFF}$ " at Pin30. (cf. Fig.D25)
D24	Sand Castle Pulse Level / V_{SCPH} / V_{SCPM} / V_{SCPL}	All:Preset	Measure " V_{SCPH} " / " V_{SCPM} " / " V_{SCPL} " at Pin30. 
D25	Vertical Ramp Amplitude / V_{VRAMP}	All:Preset	Measure the V Ramp amplitude at Pin24, that is " V_{VRAMP} ".
D26	Vertical AMP Gain / G_{VAMP} Vertical AMP Max.Output Level / V_{VOMAX} Vertical AMP Min.Output Level / V_{VOMIN}	All:Preset	(1)Let Pin26 be open. (2)Changing the Pin25 DC voltage, measure " V_{VOMAX} " / " V_{VOMIN} " / " G_{VAMP} " according to a following figure. 
D27	Vertical AMP Max.Output Current / I_{VOMAX}	All:Preset	(1)Supply 7V to Pin25. (2)Measure the current from Pin26 to GND, that is " I_{VOMAX} ".

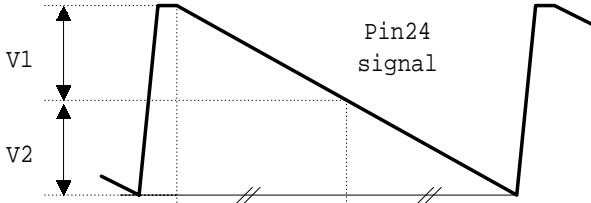
Note	Items/Symbols	Bus conditioins	Measurement methods
D28	Vertical NFB Amplitude / V_{NFB} Vertical Amplitude Variable Range / $\bullet V_{VRAMPH}$ / $\bullet V_{VRAMPL}$	V Size:0/32/63 Others:Preset	(1)Measure the amplitude of NFB V Ramp at Pin25, that is " V_{NFB} ". (2)Measure the amplitude of NFB V Ramp at Pin25 for V-Size 0/63, that is V_{NFBMIN} / V_{NFBMAX} . (3)Calculate; " $\bullet V_{VRAMPH}$ "= $(V_{NFBMAX}-V_{NFB})/V_{NFB} \times 100$ " $\bullet V_{VRAMPL}$ "= $(V_{NFBMIN}-V_{NFB})/V_{NFB} \times 100$
D29	Vertical Linearity Variable Range / $\bullet V_{LIN1+}$ / $\bullet V_{LIN1-}$ / $\bullet V_{LIN2+}$ / $\bullet V_{LIN2-}$	V Linearity:0/8/15 Others:Preset	(1)For V Linearity 8, measure V_1 (from center to max.) and V_2 (from center to min.) at Pin24 according to a follownig figure. (2)For V Linearity 15/0, measure V_{LIN1+} / V_{LIN1-} and V_{LIN2+} / V_{LIN2-} . (3)Calculate; " $\bullet V_{LIN1+}$ "= $(V_{LIN1+}-V_1)/V_1 \times 100$ " $\bullet V_{LIN1-}$ "= $(V_{LIN1-}-V_1)/V_1 \times 100$ " $\bullet V_{LIN2+}$ "= $(V_{LIN2+}-V_2)/V_2 \times 100$ " $\bullet V_{LIN2-}$ "= $(V_{LIN2-}-V_2)/V_2 \times 100$ 
D30	Vertical S Correction Variable Range / $\bullet V_{S1+}$ / $\bullet V_{S1-}$ / $\bullet V_{S2+}$ / $\bullet V_{S2-}$	V S Corr.:0/8/15 Others:Preset	(1)For V S Correction:8, measure V_1 and V_2 at Pin24 according to a figure of NOTE:D32 . (2)For V S Correction:15/0, measure V_{S1+} / V_{S1-} and V_{S2+} / V_{S2-} . (3)Calculate; " $\bullet V_{S1+}$ "= $(V_{S1+}-V_1)/V_1 \times 100$ " $\bullet V_{S1-}$ "= $(V_{S1-}-V_1)/V_1 \times 100$ " $\bullet V_{S2+}$ "= $(V_{S2+}-V_2)/V_2 \times 100$ " $\bullet V_{S2-}$ "= $(V_{S2-}-V_2)/V_2 \times 100$
D35	Vertical Voltage / V_{VG}	Guard All:Preset	Decreasing the Pin25 voltage from 5V, measure the voltage at which Pin20 output drops to blanking level, that is " V_{VG} ".

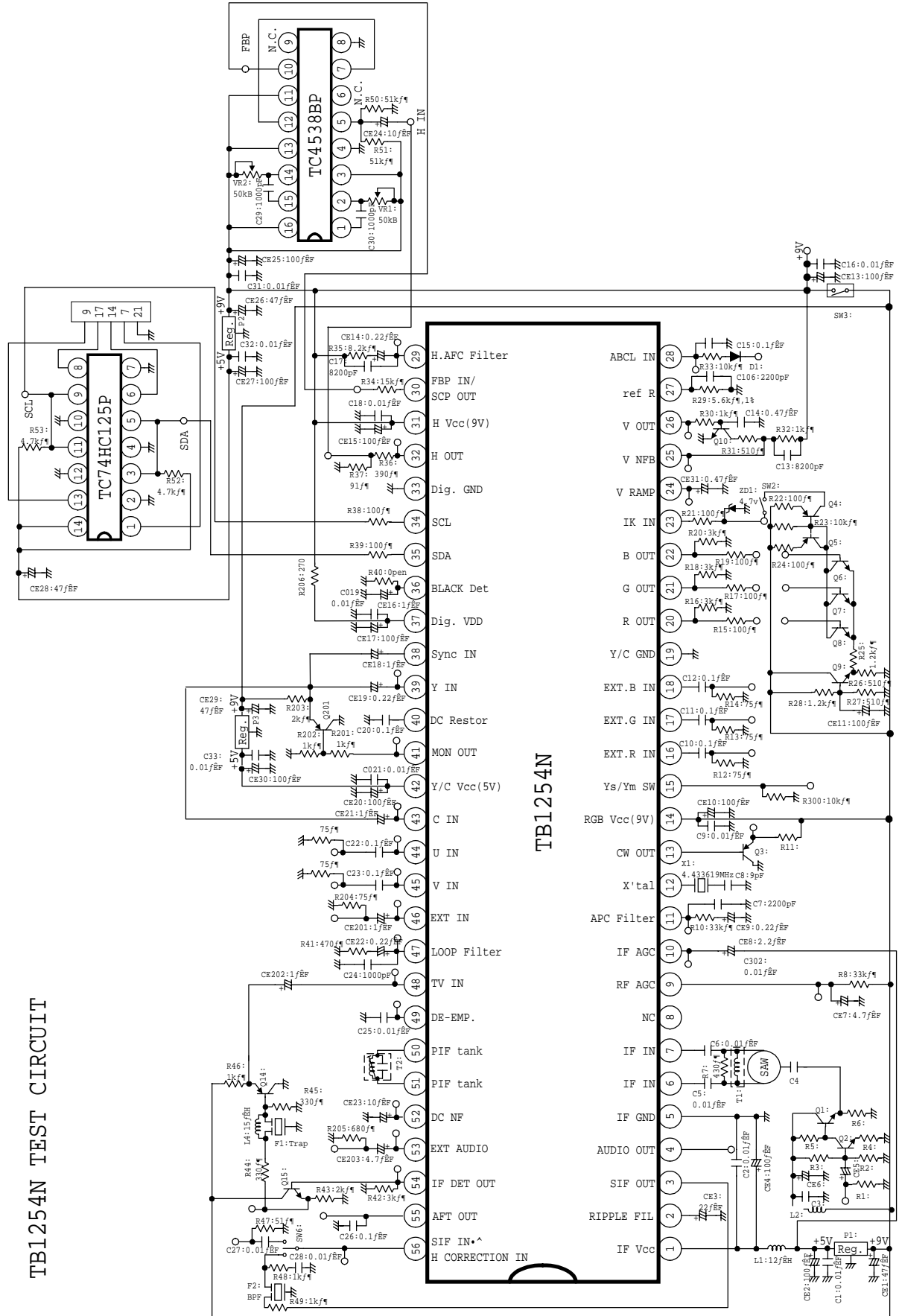

TB1254N TEST CIRCUIT

TB1254N

OUTLINE DRAWING

SDIP56-P-600-1.78

Unit : mm

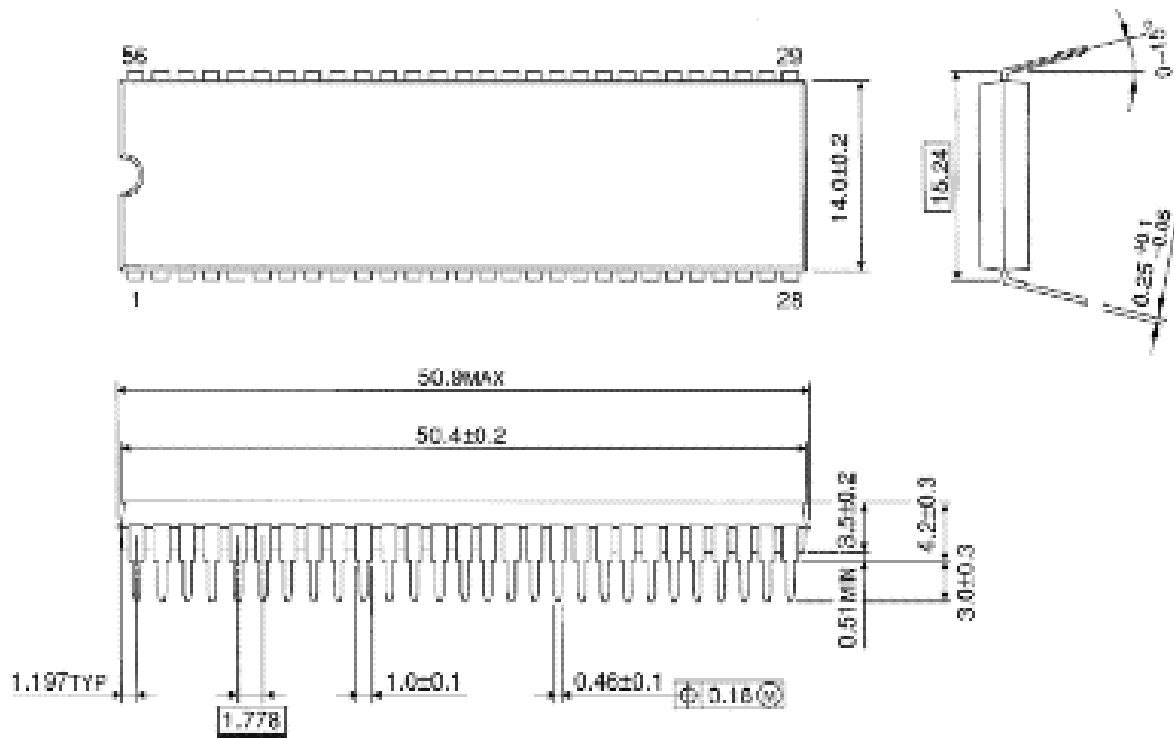

••••	•••	•••
p.1 IF stage	for L system,AM sound demodulation	••
Chroma stage	U/V input ports	Cb/Cr input ports
P.2 Block Diagram Pin9	RFAGC/SIF in	RF AGC
Ripple filter		BIAS
	L-SECAM AM	••
H.AFC	•••••	•••••
P.3 Pin3 SIF OUT Interface		
Pin4 Audio out Interface		
P.3 Pin6,7 IF IN	90dB•	90dB(•V)(Pin6-7)
	field intensity	level
P.4 Pin8 RF AGC/SIF IN	RF AGC/SIF IN	RF AGC
	This terminal also lead to 1'st SIF input pole.	••

P.4	Pin10 IF AGC	2.2mF	2.2•F
P.8	Pin36 Black DET		
P.9	Pin40 DC restor		
	Pin38 Sync in	1401IRE	140IRE
p.10	Pin44,45 U/V in	U/V in	Cb/Cr in
P.11	Pin50,51 PIF tank	27pF	18pF
p.14	RF AGC	RF AGC delay point	RF AGC delay point (Pin6-7)
		01: 65dBm	01: 65 dB(•V)
		3F: 100dBm	3F: 100 dB(•V)
P.15	DDS MODE SW...		
p.16	Split / Inter...		••
p.17	U/V SW	U/V	Cb/Cr
p.18	Self Test	01:B OUT 10:R OUT	••
p.19	Self Adj.	Self Adj.	Self Test

			00: AFT (Normal) 10: RF AGC X 1/2
Noise Det•			
p.22 (*3)	(*3)Pin 1, 4, 5, 11, 12, 19, 26, 33, 34, 35, 42, 50, 51 are weak against •...	(*3)Pin 1, 4, 5, 6, 9, 11, 12, 13, 19, 26, 31, 32, 33, 34, 35, 37, 42, 43, 50, 51 are weak against •...	
p.29 T4,T5	Cut off/Drive•spec. ••	•••	
T5 spec. ••	Drive•spec. •• min. typ. max. 3 3.5 4 -6.0 -5.5 -5.0	Drive•spec. •• min. typ. max. 2.5 3.5 4.5 -8.0 -5.5 -4.5	
T18		••	
p.35 S2	Input a signal that 4.5[MHz], 100[dBμV], 2.5[kHz]...•	Input a signal that 4.5[MHz], 100[dBμV], 25[kHz]...•	
S3	Input a signal that 4.5[MHz], 100[dBμV], 2.5[kHz]...•	Input a signal that 4.5[MHz], 100[dBμV], 25[kHz]...•	
p.36 S8	Input a signal that 4.5[MHz], 100[dBμV], 2.5[kHz]...•	Input a signal that 4.5[MHz], 100[dBμV], 25[kHz]...•	
p.48 T18		••	
p.54 pin9	RF AGC/SIF IN	RF AGC	
Pin2 Ripple filter	10•F	22•F	
p.55 Pin9	RF AGC/SIF IN	RF AGC	