

Damper Diodes (Diode modulation Type)

t_{rr} ①: $I_F/I_R (=I_F)$ 90% Recovery Point
 (ex. $I_F/I_R = 100\text{mA}/100\text{mA}$ 90% Recovery Point)
 t_{rr} ②: $I_F/I_R (=2 I_F)$ 75% Recovery Point
 (ex. $I_F/I_R = 100\text{mA}/200\text{mA}$ 75% Recovery Point)

Division	V _{RM} (V)	Part Number	I _F (AV) (A)	I _{FSM} (A)	T _j (°C)	T _{stg} (°C)	V _F (V) max	I _F (A)	I _R (μA)	I _R (H) (mA)	T _a (°C)	t _{rr} ① (μs)		t _{rr} ② (μs)		R _{th} (j-c) (°C/W)	Mass (g)	Fig. No.	Page where characteristic curve is shown
				50Hz Half-cycle Sinewave Single Shot					V _R =V _{RM} max	V _R =V _{RM} max		I _F /I _{FP} (mA)	I _F /I _{FP} (mA)						
For TV	1500	FMV-3FU	5.0	50	-40 to +150	1.4	5.0	50	0.5	100	4.0	500/500	1.3	500/1000	1.8	6.5	1	100	
	600											500/500	0.18	500/1000					
	1700	FMV-3GU	5.0	50	-40 to +150	1.5	5.0	50	0.5	100	2.0	500/500	0.8	500/1000					
	600											500/500	0.18	500/1000					
For CRT Display	1500	FMP-2FUR	5.0	50	-40 to +150	2.0	5.0	50	3	150 (T _j)	0.7	500/500	0.3	500/1000	4.0	2.1	2	102	
	600					2.5	5.0	50	3	150 (T _j)	0.1	500/500	0.05	500/1000					
	1500	FMQ-2FUR *	5.0	50	-40 to +150	1.4	5.0	50	2	150	2	500/500	0.8	500/1000	4.0	2.1			
	600					1.65	5.0	50	0.5	150	0.15	500/500	0.07	500/1000					
	1500	FMT-2FUR	5.0	50	-40 to +150	1.8	5.0	50	2	150	1.0	500/500	—	500/1000	4.0	2.1	—	—	
	600					1.9	5.0	50	7	150	0.1	500/500	—	500/1000					
	1500	FMP-3FU	5.0	50	-40 to +150	2.0	5.0	50	0.5	100	0.7	500/500	0.3	500/1000	1.8	6.5	1	101	
	600					2.5	5.0	50	0.5	100	0.1	500/500	0.05	500/1000					
	1700	FMQ-3GU	5.0	50	-40 to +150	2.0	5.0	500	1	100	0.7	500/500	0.3	500/1000	1.8	6.5			
	800					4.0	5.0	100	0.5	100	0.07	500/500	0.04	500/1000					

* : Under development

External Dimensions Flammability: UL94V-0 or Equivalent (Unit: mm)

1

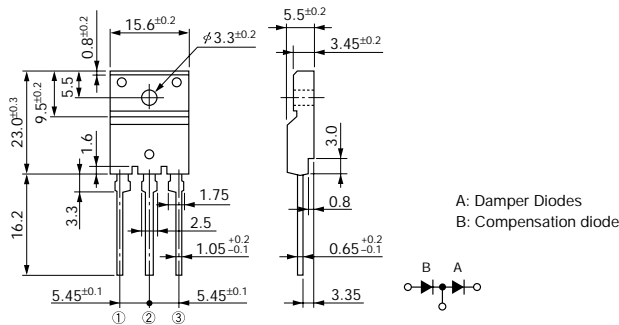

2

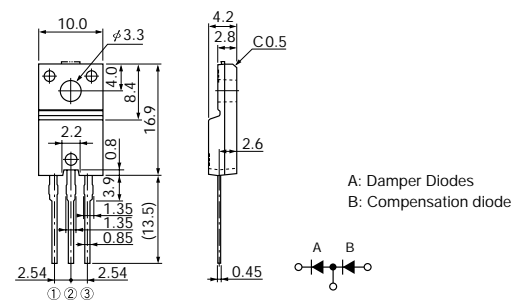

Characteristic Curves Damper Diodes

FMP-3FU

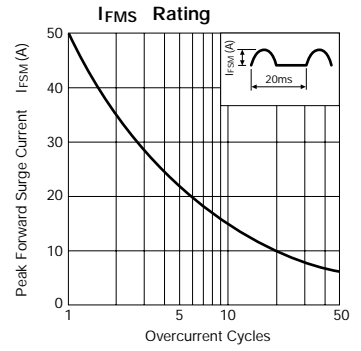
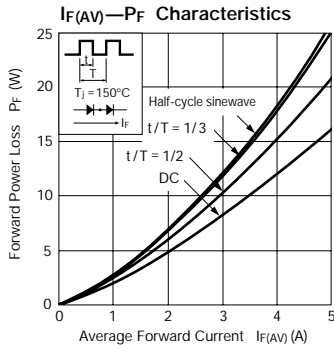
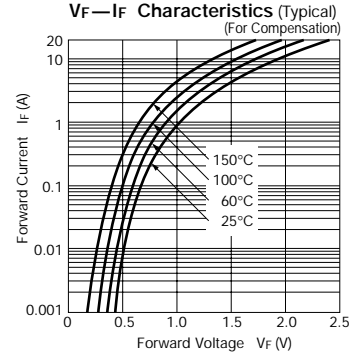
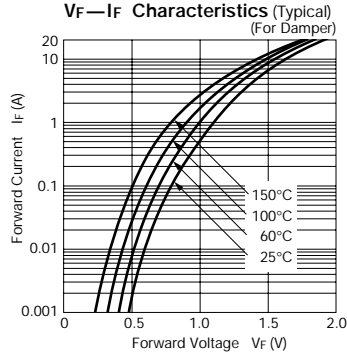
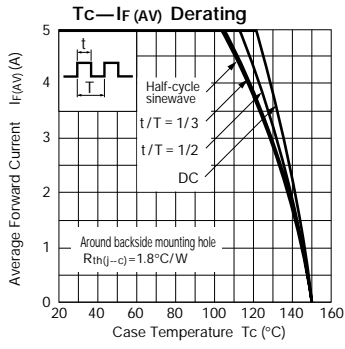

FMO-3GU

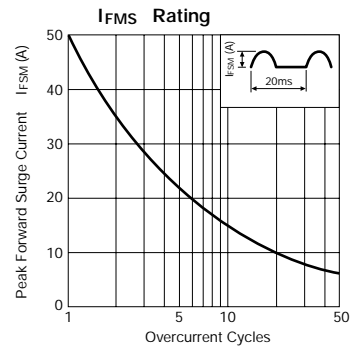
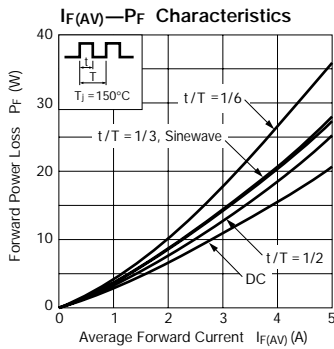
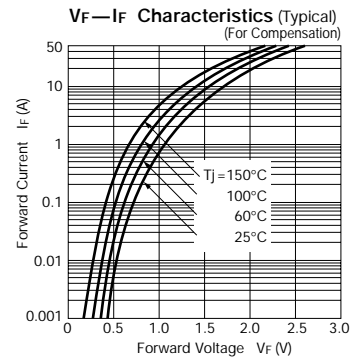
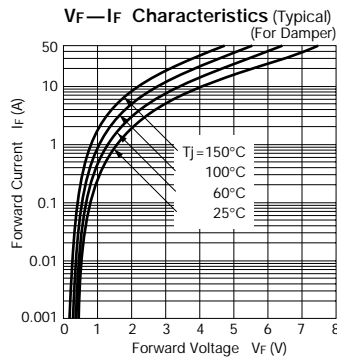
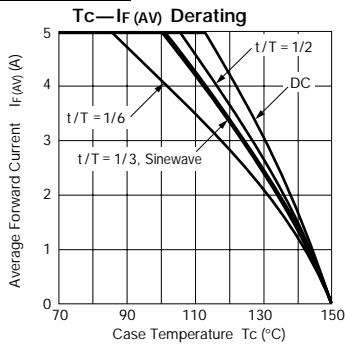

This datasheet has been download from:

www.datasheetcatalog.com

Datasheets for electronics components.