

International
IOR Rectifier

QUIETIR Series
30EPF.. 30CPF..

FAST SOFT RECOVERY RECTIFIER DIODE

Description/Features

The 30EPF.. & 30CPF.. soft recovery **QUIETIR** rectifier series has been optimized for combined short reverse recovery time and low forward voltage drop.

The glass passivation ensures stable reliable operation in the most severe temperature and power cycling conditions.

Typical applications are:

- Output rectification and freewheeling in inverters, choppers and converters
- and input rectifications where severe restrictions on conducted EMI should be met.
- 30CPF series is a drop in replacement for 25CPF Series (parallel connection only)

Major Ratings and Characteristics

Characteristics	30EPF.. 30CPF..	Units
$I_{F(AV)}$ Sinusoidal waveform	30	A
V_{RRM}	200 to 600	V
I_{FSM}	350	A
V_F @ 10A, $T_J=25^\circ\text{C}$	1.2	V
t_{rr} @ 1A, 100A/ μs	60	ns
T_J	-40 to 150	$^\circ\text{C}$



$$V_F < 1.2\text{V @ } 10\text{A}$$

$$t_{rr} = 60\text{ns}$$

$$V_{RRM} \text{ 200 to } 600\text{V}$$

Package Outline

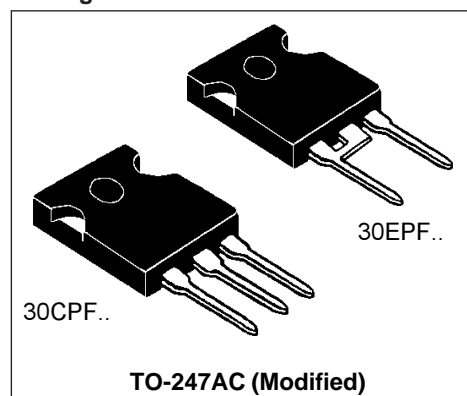

Voltage Ratings

Part Number	V_{RRM} , maximum peak reverse voltage V	V_{RSM} , maximum non repetitive peak reverse voltage V	I_{RRM} 150°C mA
30EPF02, 30CPF02	200	300	2
30EPF04, 30CPF04	400	500	
30EPF06, 30CPF06	600	700	

Absolute Maximum Ratings

Parameters	30.PF..	Units	Conditions
$I_{F(AV)}$ Max. Average Forward Current	30	A	@ $T_c = 98^\circ\text{C}$, 180° conduction half sine wave
I_{FSM} Max. Peak One Cycle Non-Repetitive Surge Current	300	A	10ms Sine pulse, rated V_{RRM} applied
	350		10ms Sine pulse, no voltage reapplied
I^2t Max. I^2t for fusing	450	A^2s	10ms Sine pulse, rated V_{RRM} applied
	636		10ms Sine pulse, no voltage reapplied
$I^2\sqrt{t}$ Max. $I^2\sqrt{t}$ for fusing	6360	$A^2\sqrt{s}$	$t = 0.1$ to 10ms, no voltage reapplied

Electrical Specifications

Parameters	30.PF..	Units	Conditions
V_{FM} Max. Forward Voltage Drop	1.41	V	@ 30A, $T_J = 25^\circ\text{C}$
r_t Forward slope resistance	12.5	$m\Omega$	$T_J = 150^\circ\text{C}$
$V_{F(TO)}$ Threshold voltage	0.9	V	
I_{RM} Max. Reverse Leakage Current	0.1	mA	$T_J = 25^\circ\text{C}$
	2.0		$T_J = 150^\circ\text{C}$

$V_R = \text{rated } V_{RRM}$

Typical Recovery Characteristics

Parameters	30.PF..	Units	Conditions
t_{rr} Reverse Recovery Time	160	ns	$I_F @ 20\text{Apk}$ @ 100A/ μs @ 25°C
I_{rr} Reverse Recovery Current	10	A	
Q_{rr} Reverse Recovery Charge	1.25	μC	
S Snap Factor t_b/t_a	0.6	typical	

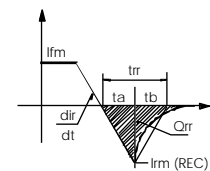

Thermal-Mechanical Specifications

Parameters	30.PF..	Units	Conditions
T_J Max. Junction Temperature Range	-40 to 150	°C	
T_{stg} Max. Storage Temperature Range	-40 to 150	°C	
R_{thJC} Max. Thermal Resistance Junction to Case	0.8	°C/W	DC operation
R_{thJA} Max. Thermal Resistance Junction to Ambient	40	°C/W	
R_{thCS} Typical Thermal Resistance, Case to Heatsink	0.2	°C/W	Mounting surface , smooth and greased
wt Approximate Weight	6 (0.21)	g (oz.)	
T Mounting Torque	Min.	6 (5)	Kg-cm (lbf-in)
	Max.	12 (10)	
Case Style	TO-247AC		JEDEC (Modified)

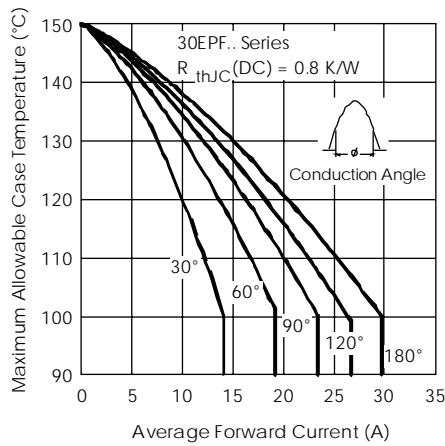

Fig. 1 - Current Rating Characteristics

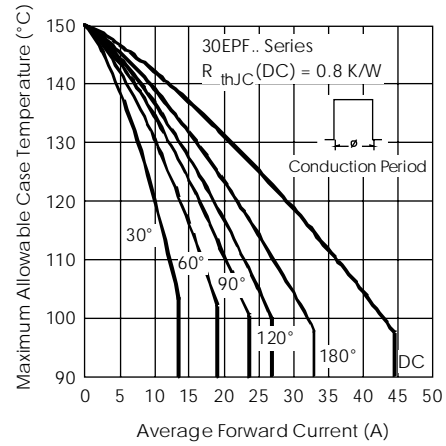

Fig. 2 - Current Rating Characteristics

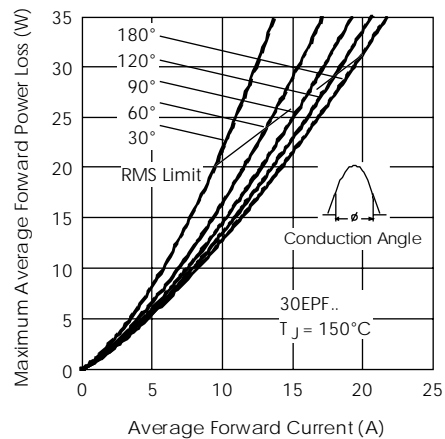

Fig. 3 - Forward Power Loss Characteristics

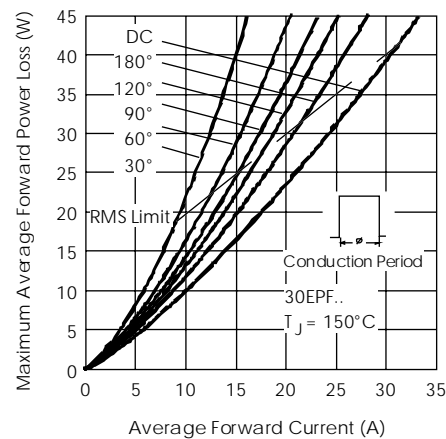

Fig. 4 - Forward Power Loss Characteristics

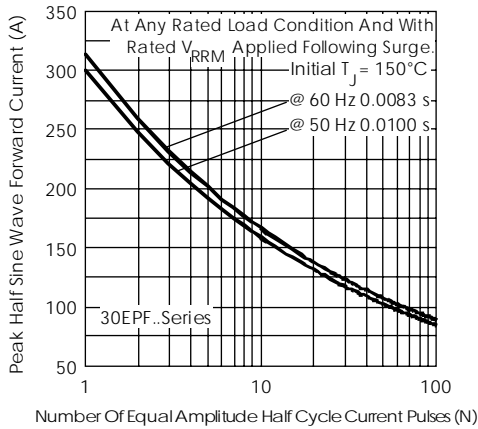

Fig. 5 - Maximum Non-Repetitive Surge Current

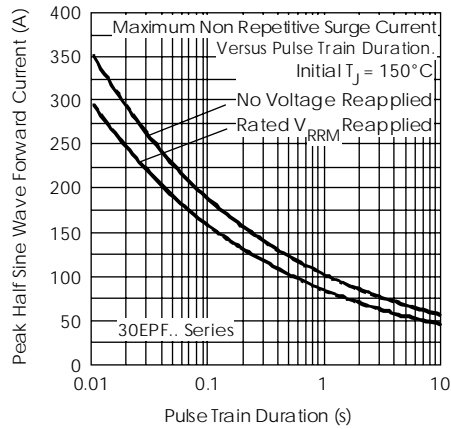

Fig. 6 - Maximum Non-Repetitive Surge Current

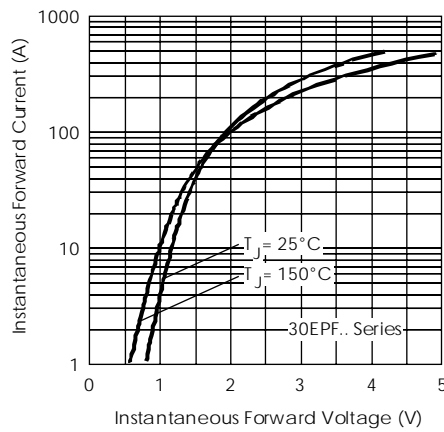

Fig. 7 - Forward Voltage Drop Characteristics

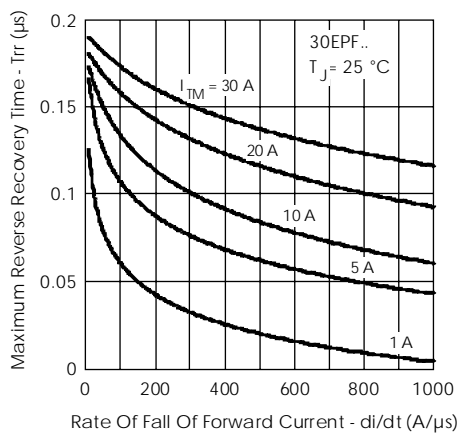

Fig. 8 - Recovery Time Characteristics, $T_J = 25^\circ\text{C}$

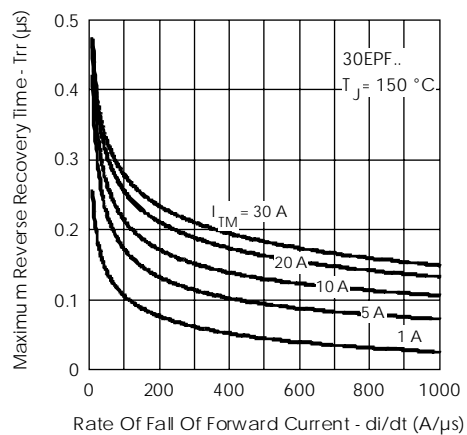

Fig. 9 - Recovery Time Characteristics, $T_J = 150^\circ\text{C}$

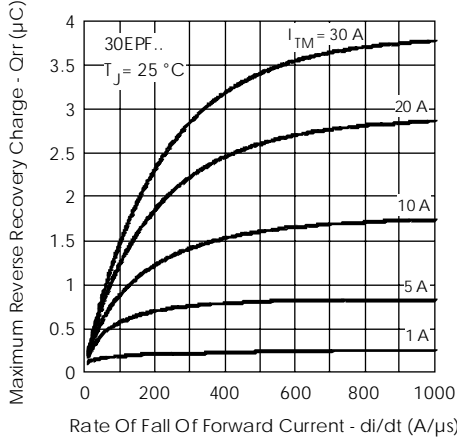

Fig. 10 - Recovery Charge Characteristics, $T_J = 25^\circ\text{C}$

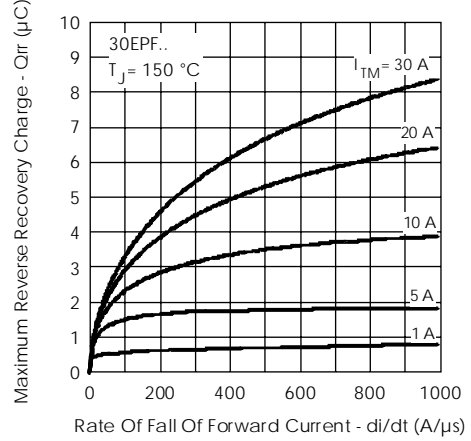

Fig. 11 - Recovery Charge Characteristics, $T_J = 150^\circ\text{C}$

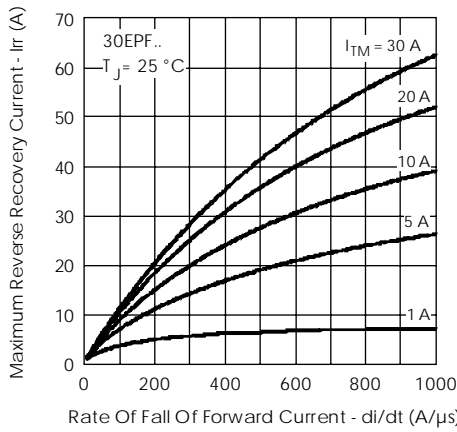

Fig. 12 - Recovery Current Characteristics, $T_J = 25^\circ\text{C}$

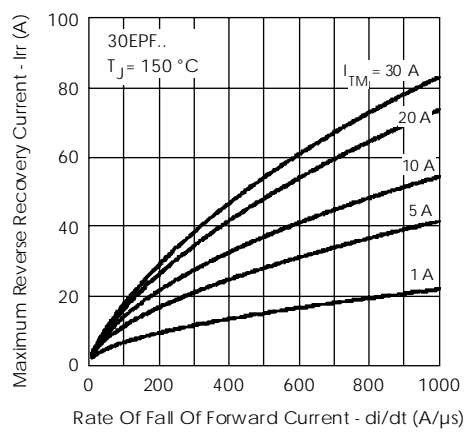

Fig. 13 - Recovery Current Characteristics, $T_J = 150^\circ\text{C}$

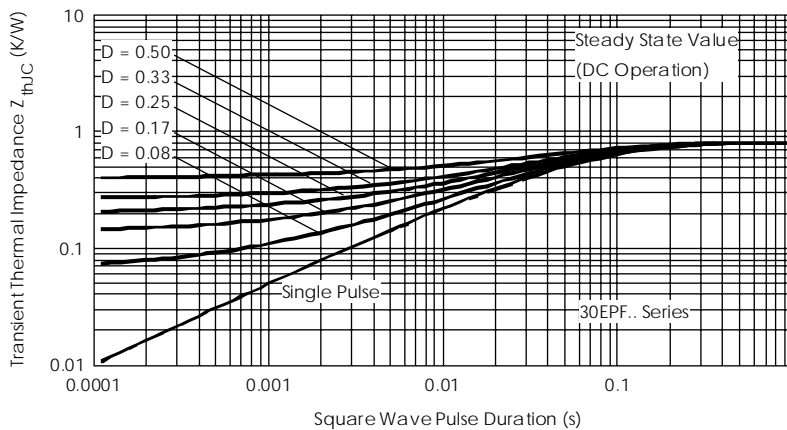
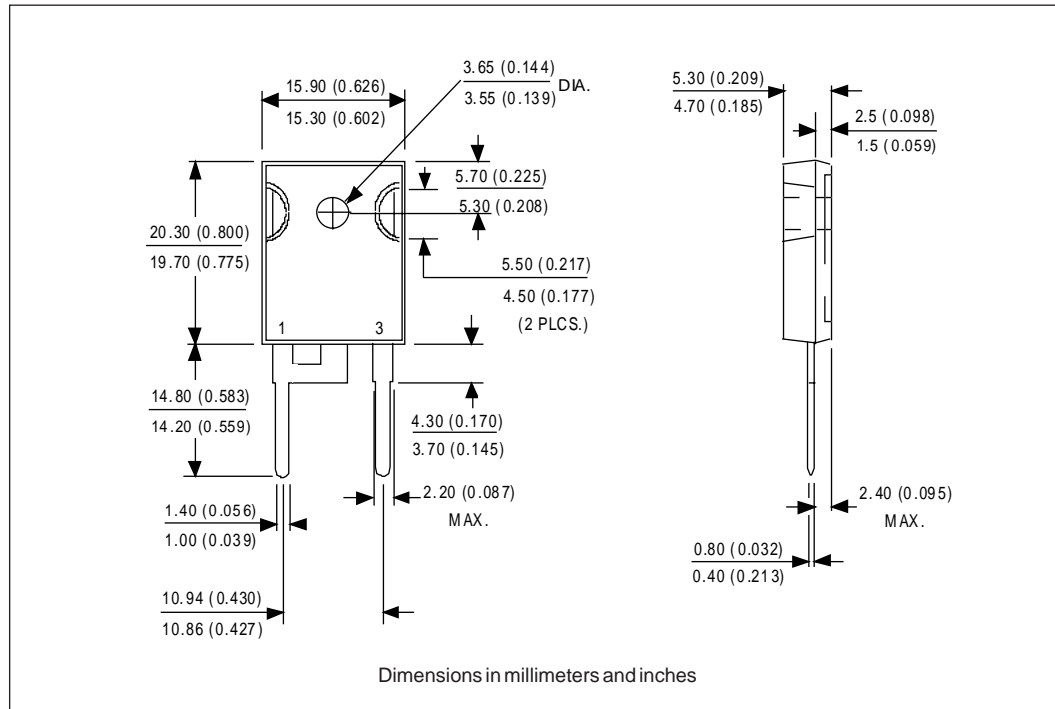

Fig. 14 - Thermal Impedance Z_{thJC} Characteristics

Outline Table



Ordering Information Table

Device Code				
30	E	P	F	06
①	②	③	④	⑤

1	- Current Rating
2	- Circuit Configuration: E = Single Diode
3	- Package: P = TO-247AC (Modified)
4	- Type of Silicon: F = Fast Recovery
5	- Voltage code: Code x 100 = V_{RRM}

02	= 200V
04	= 400V
06	= 600V

BASE
CATHODE

②

① ③

CATHODE ANODE

Outline Table

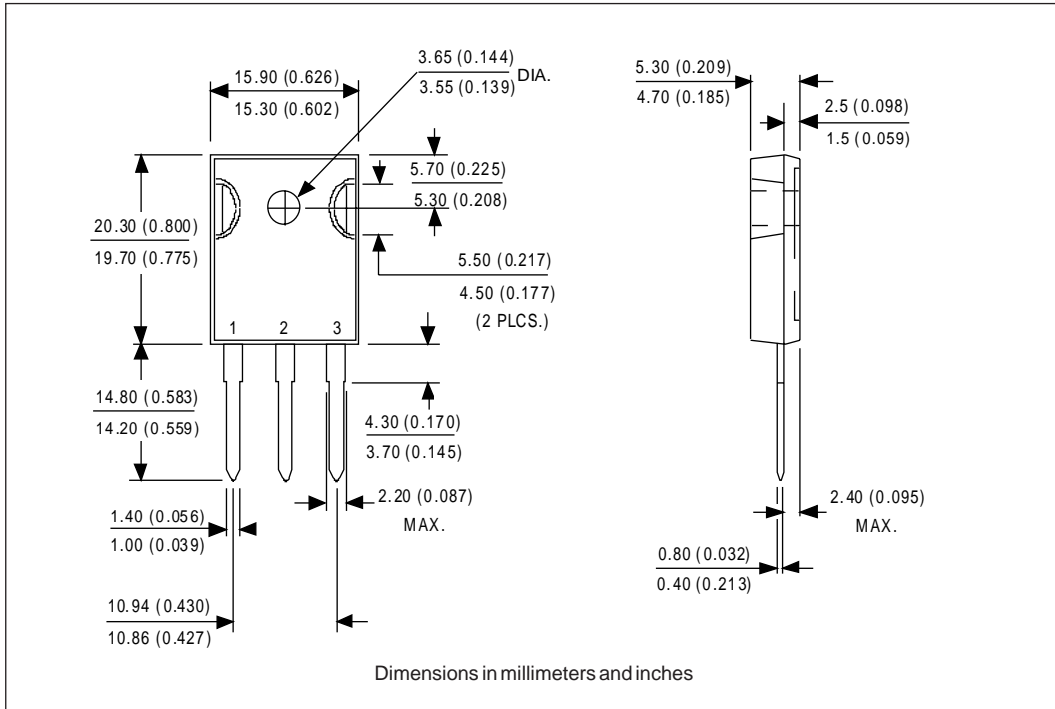

Ordering Information Table

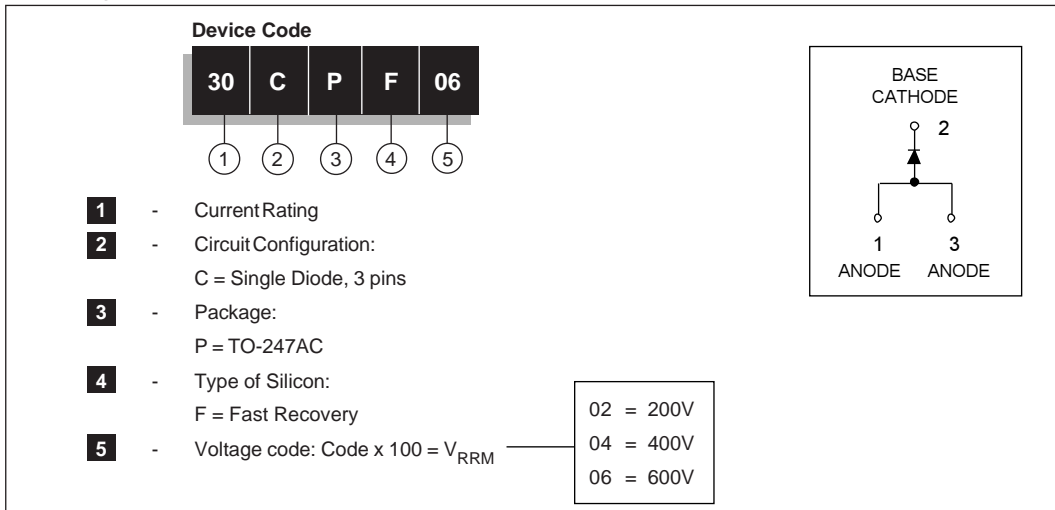

This datasheet has been download from:

www.datasheetcatalog.com

Datasheets for electronics components.