

TRIACS

AC03DSM, AC03FSM AC03DSMA, AC03FSMA

3 A MOLD ISOLATED TRIAC

The AC03□_ISM and AC03□_ISMA are all diffused mold type triac granted RMS On-state current 3 Amps, with rated voltages up to 600 volts.

FEATURES

- Isolated plastic package (Modified TO-220AB)
- 30 A Surge current

APPLICATIONS

- Motor speed control
- Lamp dimmer, Temperature controllers
- Various solid state switches, etc.

MAXIMUM RATINGS

ITEM	SYMBOL	AC03DSM AC03DSMA	AC03FSM AC03FSMA	UNIT	NOTE
Repetitive Peak Off-State Voltage	V_{DRM}	400	600	V	
Non-repetitive Peak Off-State Voltage	V_{DSM}	500	700	V	
RMS On-State Current	$I_T(RMS)$	3 ($T_C = 109^\circ C, \theta = 180^\circ$)		A	See Fig. 12, 13
Surge On-State Current	I_{TSM}	30 (50 Hz 1 cycle)		A	See Fig. 2
Fusing Current	$\int i^2 dt$	4.0		$A^2 s$	
Peak Gate Power Dissipation	P_{GM}	3 ($f \geq 50$ Hz, Duty ≤ 10 %)		W	
Average Gate Power Dissipation	$P_{G(AV)}$	0.3		W	
Peak Gate Current	I_{GM}	± 0.5 ($f \geq 50$ Hz, Duty ≤ 10 %)		A	
Junction Temperature	T_j	-40 to +125		$^\circ C$	
Storage Temperature	T_{stg}	-55 to +150		$^\circ C$	
Isolation Voltage	—	1500 (AC 1 min)		V_{RMS}	Only AC03□_ISM

ELECTRICAL CHARACTERISTICS (T_j = 25 °C)

ITEM	SYMBOL	TEST CONDITIONS	MIN.	TYP.	MAX.	UNIT	NOTE	
Peak Off-State Current	I _{DRM}	V _{DM} = V _{DORM} T _j = 125 °C	—	—	1	mA		
On-State Voltage	V _{TM}	I _{TM} = 5 A	—	—	1.8	V	See Fig. 1	
Gate-trigger Current	I _{GT}	V _{DM} = 12 V R _L = 30 Ω	T ₂ +, G+	—	—	15	mA	See Fig. 4, 5
			T ₂ -, G+	—	—	45		
			T ₂ +, G-	—	—	15		
			T ₂ -, G-	—	—	15		
Gate-trigger Voltage	V _{GT}	V _{DM} = 12 V R _L = 30 Ω	T ₂ +, G+	—	—	1.5	V	See Fig. 4, 5
			T ₂ -, G+	—	—	2.0		
			T ₂ -, G-	—	—	1.5		
			T ₂ +, G-	—	—	1.5		
Gate Non-Trigger Voltage	V _{GD}	T _j = 125 °C, V _{DM} = 1/2 V _{DORM}	0.2	—	—	V		
Commutating dV/dt	(dv/dt) _C	T _j = 125 °C (di _T /dt) _C = -1.6 A/ms V _{DM} = 400 V	5	—	—	V/μs		
Holding Current	I _H	V _D = 24 V, I _{TM} = 5 A	—	5	—	mA		
Thermal Resistance	R _{th(j-c)}	Junction to Case	—	—	4.5	°C/W	See Fig. 7	
	R _{th(j-a)}	Junction to Ambient	—	—	65	°C/W		

PACKAGE DIMENSIONS (Unit : mm)

AC03DSM, AC03FSM

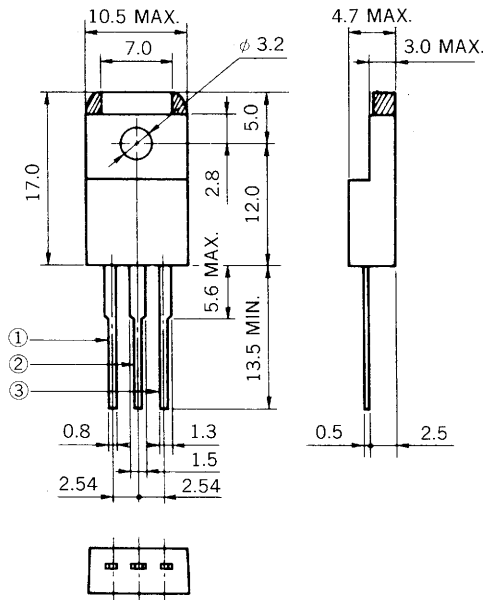

▨ Mold Coating

AC03DSMA, AC03FSMA

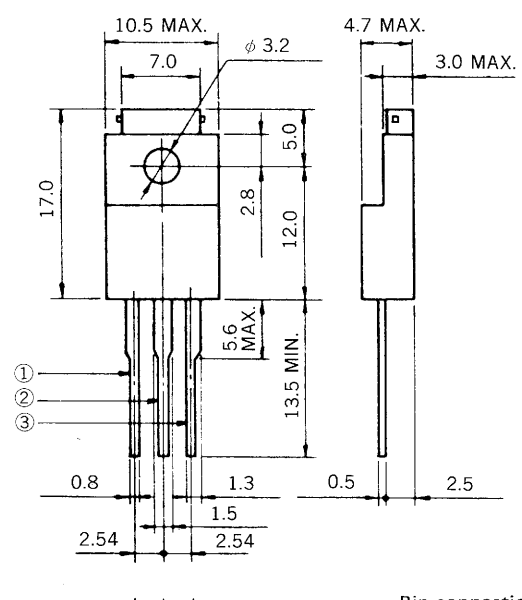

Pin connection

- ① T₁
- ② T₂
- ③ Gate

CHARACTERISTICS

Fig. 1 $i_T - v_T$ CHARACTERISTIC

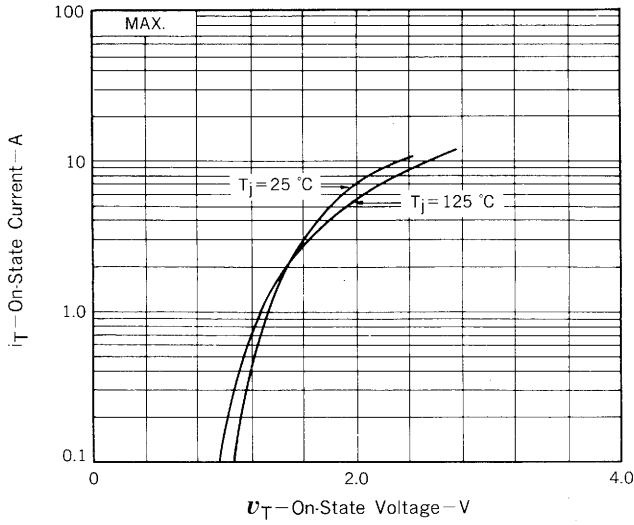

Fig. 2 I_{TSM} RATING

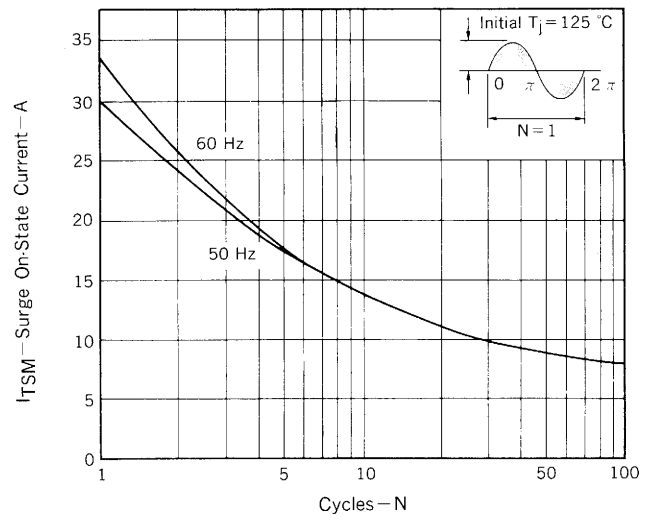

Fig. 3 $V_G - I_G$ RATING

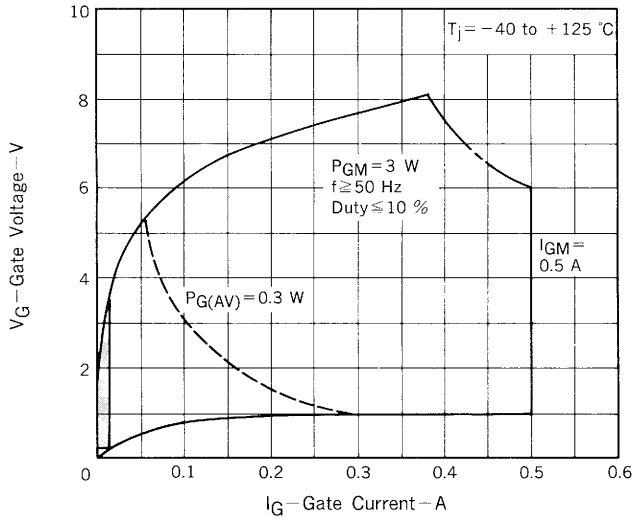

Fig. 4 $V_{GT} - I_{GT}$ CHARACTERISTIC

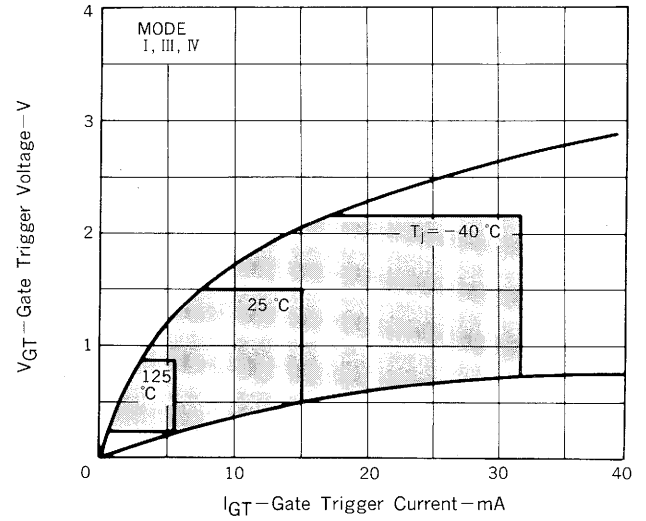

Fig. 5 $V_{GT} - I_{GT}$ CHARACTERISTIC

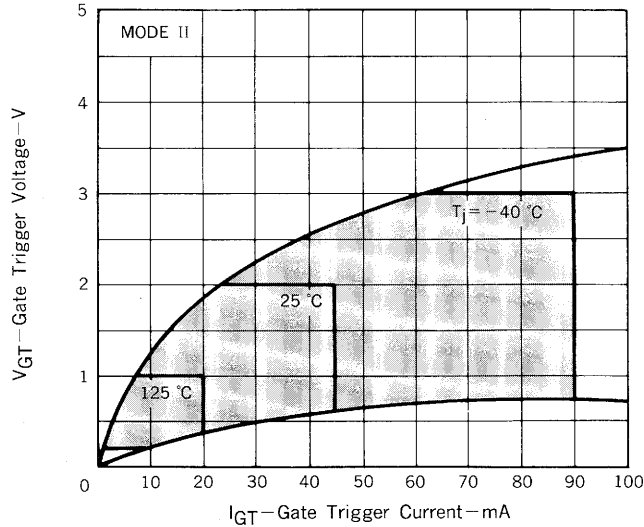

Fig. 6 $I_{GT} - T_a$ TYPICAL DISTRIBUTION

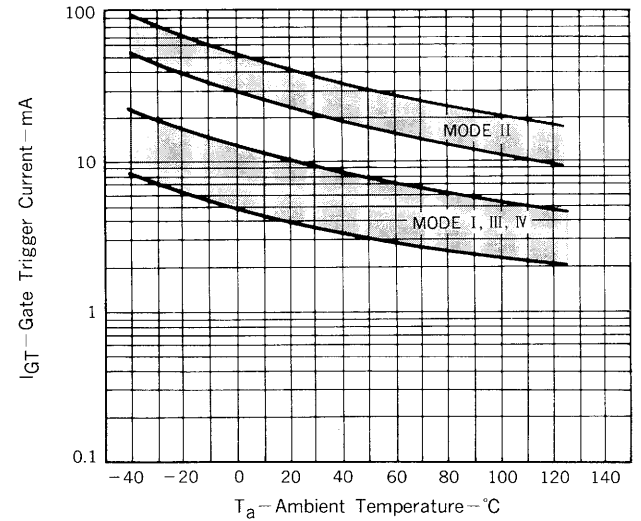

Fig. 7 $V_{GT} - T_a$ TYPICAL DISTRIBUTION

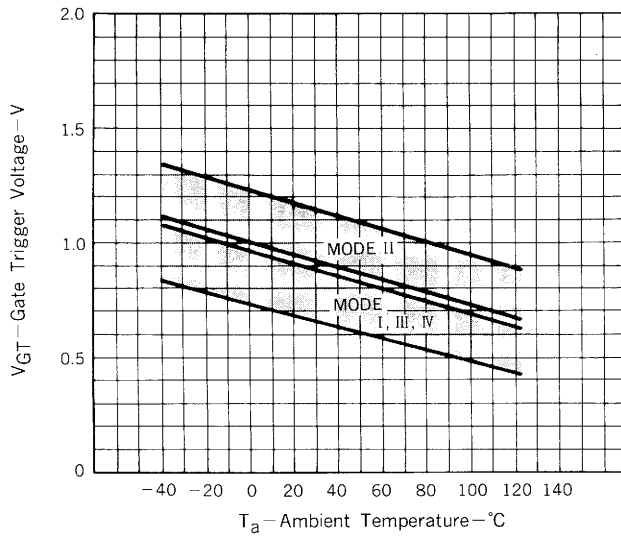

Fig. 8 $i_{GT} - \tau$ TYPICAL DISTRIBUTION

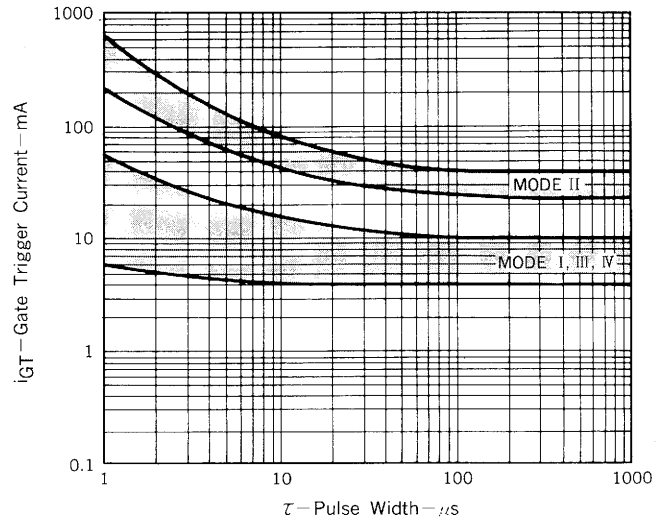

Fig. 9 $v_{GT} - \tau$ TYPICAL DISTRIBUTION

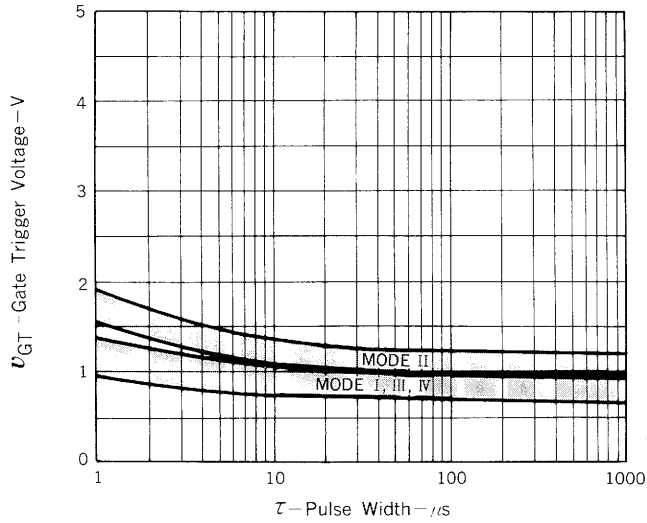

Fig. 10 $I_H - T_a$ TYPICAL DISTRIBUTION

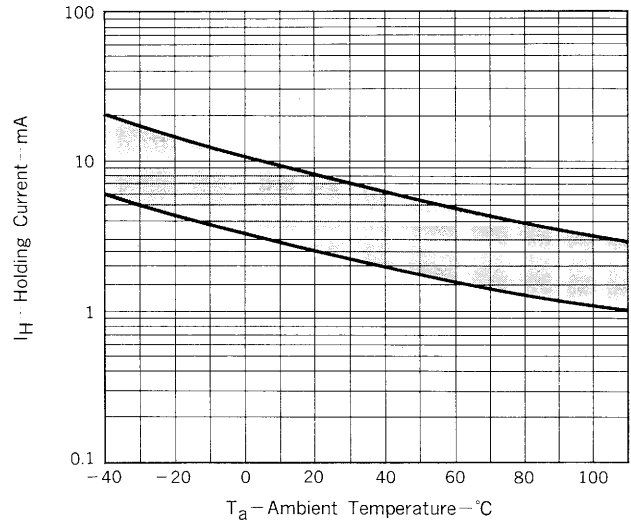

Fig. 11 $P_{T(AV)} - I_{T(RMS)}$ CHARACTERISTIC

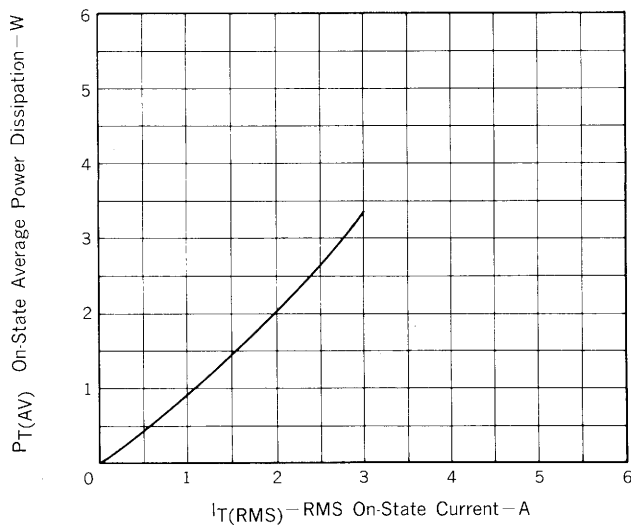

Fig. 12 $T_c - I_{T(RMS)}$ RATING

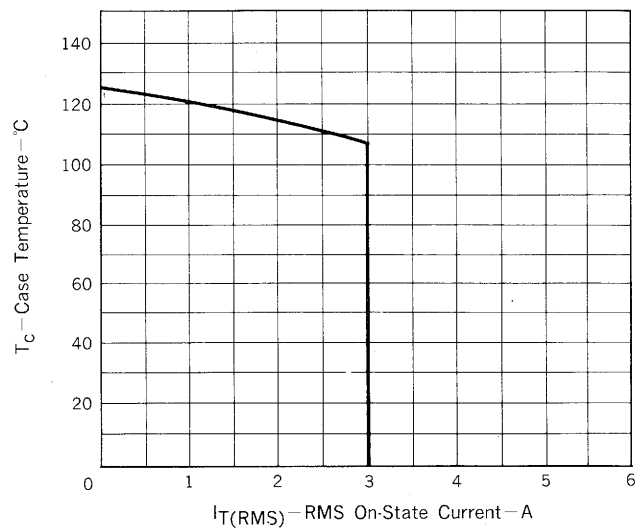

Fig. 13 $T_a - I_{T(RMS)}$ RATING

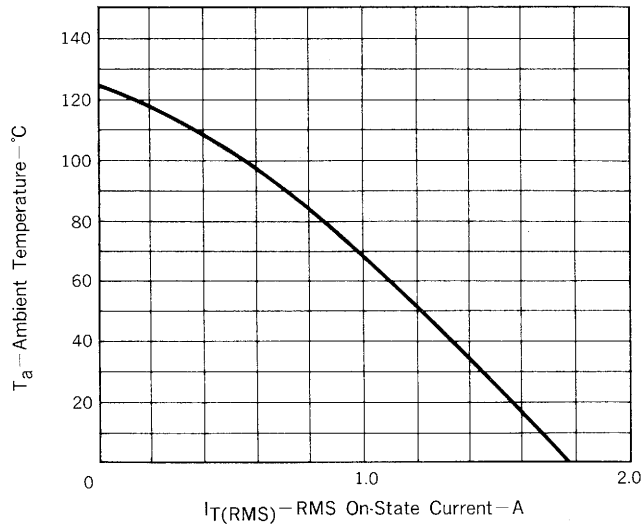

Fig. 14 Z_{th} CHARACTERISTIC

