

Photo Modules for PCM Remote Control Systems

Available types for different carrier frequencies

Type	fo	Type	fo
TSOP2230YA1	30 kHz	TSOP2233YA1	33 kHz
TSOP2236YA1	36 kHz	TSOP2237YA1	36.7 kHz
TSOP2238YA1	38 kHz	TSOP2240YA1	40 kHz
TSOP2256YA1	56 kHz		

Description

The TSOP22..YA1 – series are miniaturized receivers for infrared remote control systems. PIN diode and preamplifier are assembled on lead frame, the epoxy package is designed as IR filter.

The demodulated output signal can directly be decoded by a microprocessor. The main benefit is the reliable function even in disturbed ambient and the protection against uncontrolled output pulses.

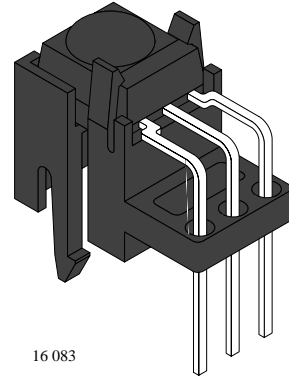

16 083

Features

- Photo detector and preamplifier in one package
- Internal filter for PCM frequency
- TTL and CMOS compatibility
- Output active low
- Improved shielding against electrical field disturbance
- Suitable burst length ≥ 10 cycles/burst

Special Features

- Small size package
- High immunity against disturbance light
- No occurrence of disturbance pulses at the output
- Short settling time after power on ($< 200\mu\text{s}$)
- Continuous data transmission possible (800 bursts/s)

Block Diagram

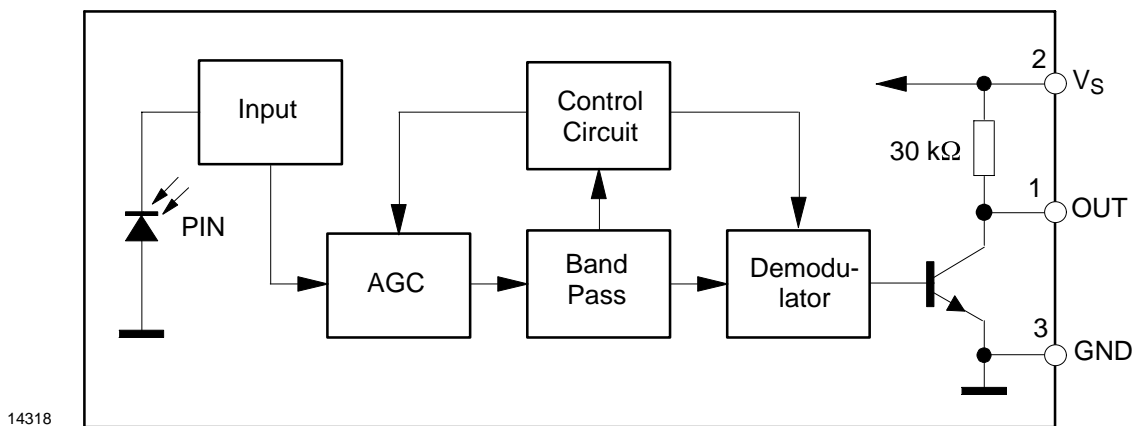

14318

Absolute Maximum Ratings

$T_{amb} = 25^{\circ}\text{C}$

Parameter	Test Conditions	Symbol	Value	Unit
Supply Voltage	(Pin 2)	V_S	-0.3...6.0	V
Supply Current	(Pin 2)	I_S	5	mA
Output Voltage	(Pin 1)	V_O	-0.3...6.0	V
Output Current	(Pin 1)	I_O	5	mA
Junction Temperature		T_j	100	$^{\circ}\text{C}$
Storage Temperature Range		T_{stg}	-25...+85	$^{\circ}\text{C}$
Operating Temperature Range		T_{amb}	-25...+85	$^{\circ}\text{C}$
Power Consumption	($T_{amb} \leq 85^{\circ}\text{C}$)	P_{tot}	50	mW
Soldering Temperature	$t \leq 10\text{ s}$, 1 mm from case	T_{sd}	260	$^{\circ}\text{C}$

Basic Characteristics

$T_{amb} = 25^{\circ}\text{C}$

Parameter	Test Conditions	Symbol	Min	Typ	Max	Unit
Supply Current (Pin 2)	$V_S = 5\text{ V}$, $E_v = 0$	I_{SD}	0.8	1.1	1.5	mA
Supply Current (Pin 2)	$V_S = 5\text{ V}$, $E_v = 40\text{ klx}$, sunlight	I_{SH}		1.4		mA
Supply Voltage (Pin 2)		V_S	4.5		5.5	V
Transmission Distance	$E_v = 0$, test signal see fig.7, IR diode TSAL6200, $I_F = 250\text{ mA}$	d		35		m
Output Voltage Low (Pin 1)	$I_{OL} = 0.5\text{ mA}$, $E_e = 0.7\text{ mW/m}^2$, $f = f_o$	V_{OL}			250	mV
Irradiance (30 – 40 kHz)	Pulse width tolerance: $t_{pi} - 5/f_o < t_{po} < t_{pi} + 6/f_o$, test signal see fig.7	$E_{e\ min}$		0.2	0.4	mW/m^2
Irradiance (56 kHz)	Pulse width tolerance: $t_{pi} - 5/f_o < t_{po} < t_{pi} + 6/f_o$, test signal see fig.7	$E_{e\ min}$		0.3	0.5	mW/m^2
Irradiance		$E_{e\ max}$	30			W/m^2
Directivity	Angle of half transmission distance	$\phi_{1/2}$		± 45		deg

Application Circuit

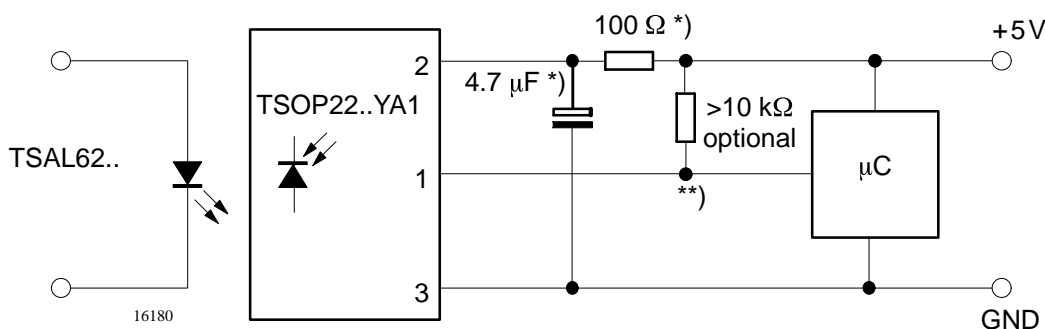

*) recommended to suppress power supply disturbances

**) The output voltage should not be hold continuously at a voltage below 3.3V by the external circuit.

Suitable Data Format

The circuit of the TSOP22..YA1 is designed in that way that unexpected output pulses due to noise or disturbance signals are avoided. A bandpassfilter, an integrator stage and an automatic gain control are used to suppress such disturbances.

The distinguishing mark between data signal and disturbance signal are carrier frequency, burst length and duty cycle.

The data signal should fulfill the following condition:

- Carrier frequency should be close to center frequency of the bandpass (e.g. 38kHz).
- Burst length should be 10 cycles/burst or longer.
- After each burst which is between 10 cycles and 70 cycles a gap time of at least 14 cycles is necessary.
- For each burst which is longer than 1.8ms a corresponding gap time is necessary at some time in the data stream. This gap time should be at least 4 times longer than the burst.
- Up to 800 short bursts per second can be received continuously.

Some examples for suitable data format are:

NEC Code, Toshiba Micom Format, Sharp Code, RC5 Code, RC6 Code, R-2000 Code.

When a disturbance signal is applied to the TSOP22..YA1 it can still receive the data signal. However the sensitivity is reduced to that level that no unexpected pulses will occur.

Some examples for such disturbance signals which are suppressed by the TSOP22..YA1 are:

- DC light (e.g. from tungsten bulb or sunlight)
- Continuous signal at 38kHz or at any other frequency
- Signals from fluorescent lamps with electronic ballast with high or low modulation (see Figure A or Figure B).

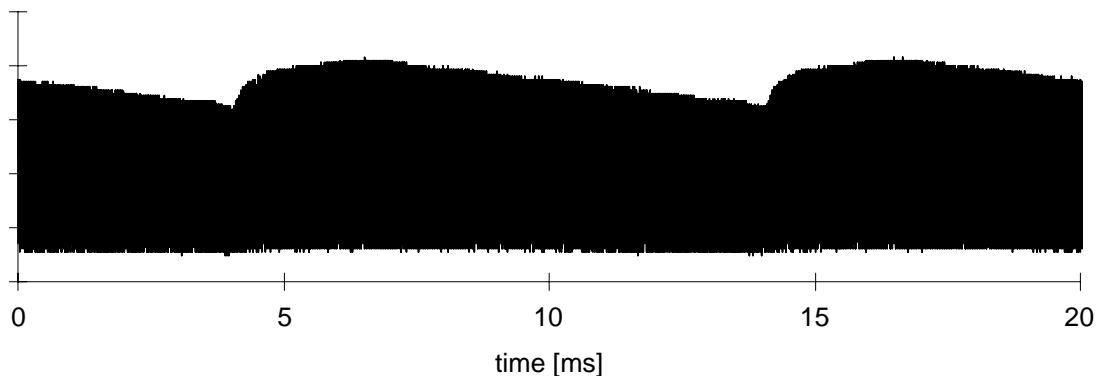

Figure A: IR Signal from Fluorescent Lamp with low Modulation

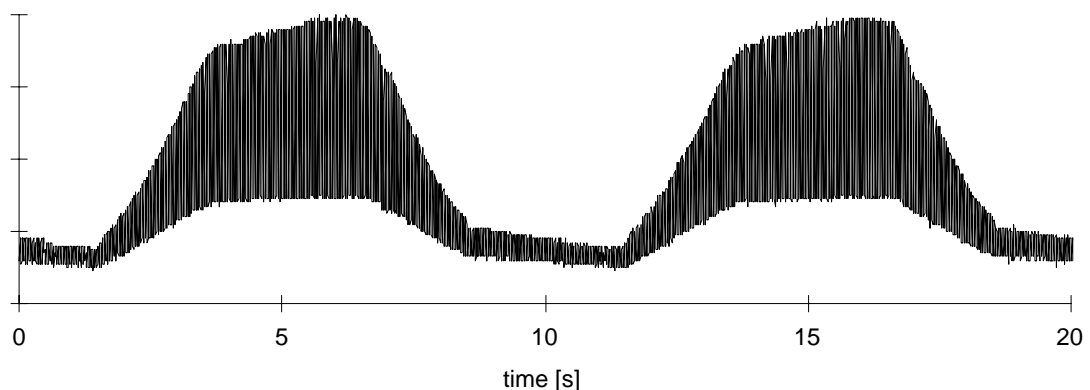

Figure B: IR Signal from Fluorescent Lamp with high Modulation

Typical Characteristics ($T_{amb} = 25^{\circ}\text{C}$ unless otherwise specified)



Figure 1. Frequency Dependence of Responsivity

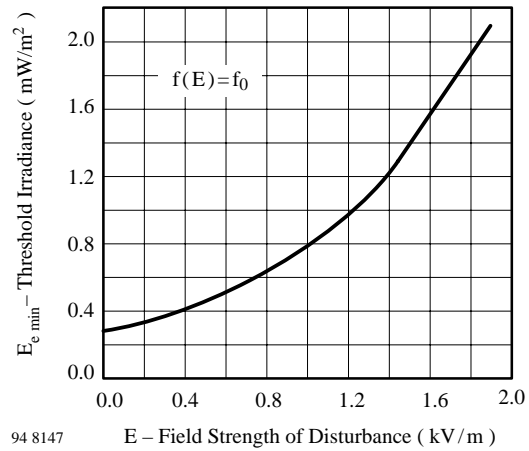

Figure 4. Sensitivity vs. Electric Field Disturbances

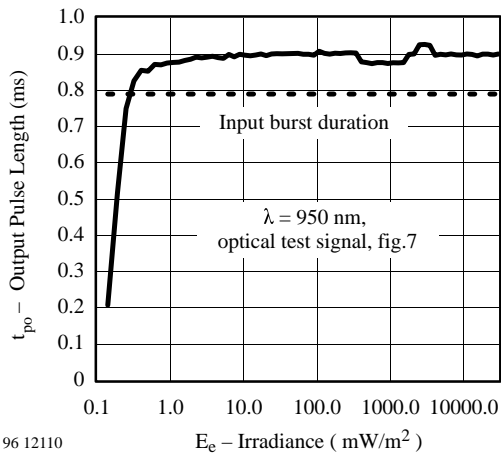

Figure 2. Sensitivity in Dark Ambient

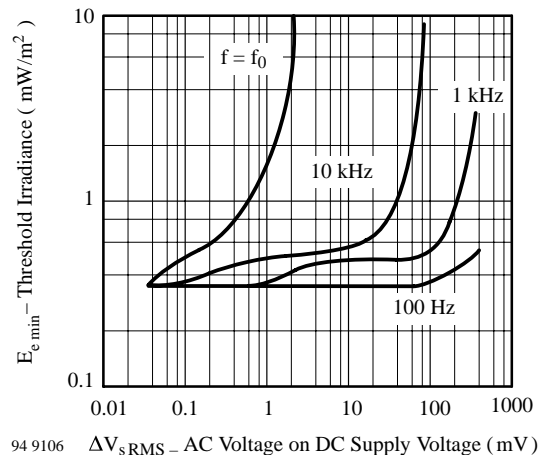

Figure 5. Sensitivity vs. Supply Voltage Disturbances



Figure 3. Sensitivity in Bright Ambient

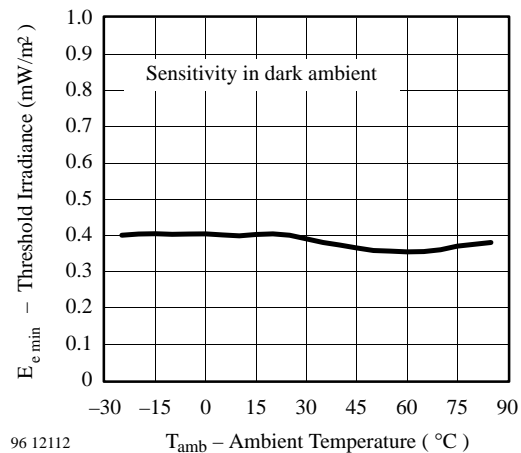

Figure 6. Sensitivity vs. Ambient Temperature

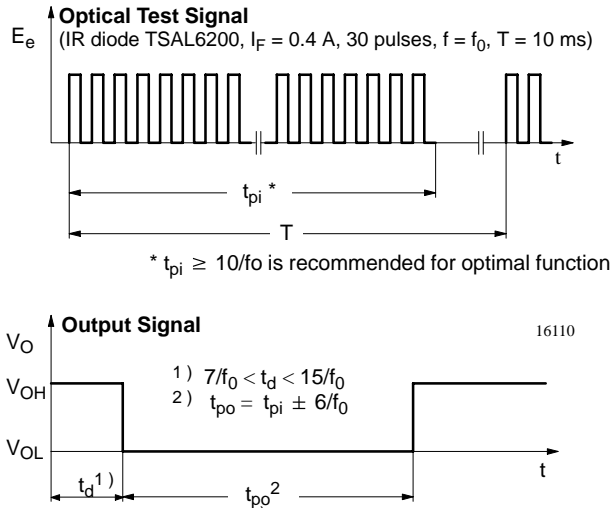

Figure 7.

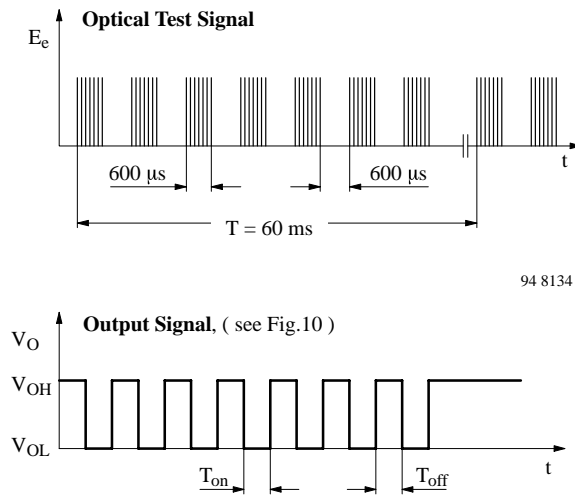

Figure 8. Output Function

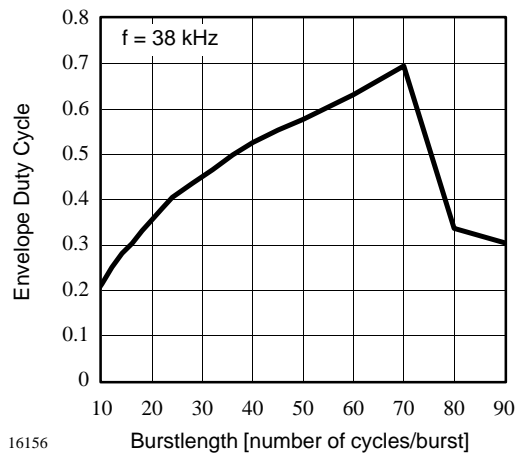

Figure 9. Max. Envelope Duty Cycle vs. Burstlength

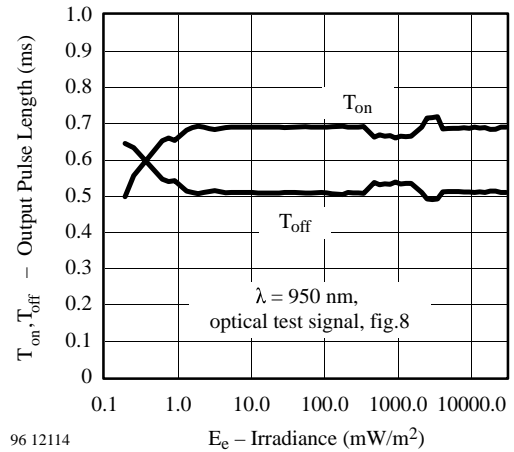

Figure 10. Output Pulse Diagram

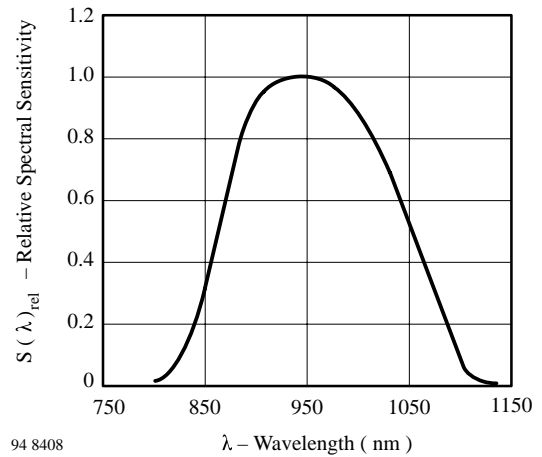

Figure 11. Relative Spectral Sensitivity vs. Wavelength

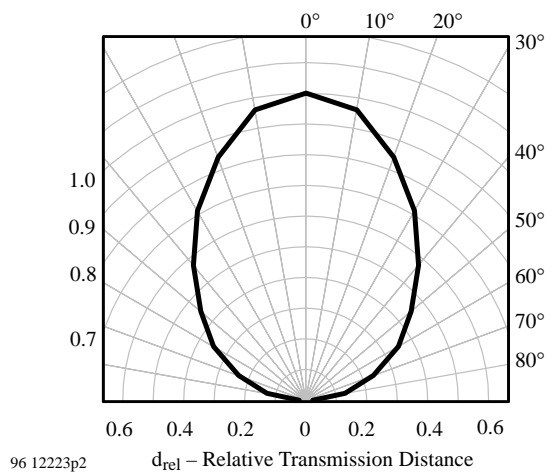
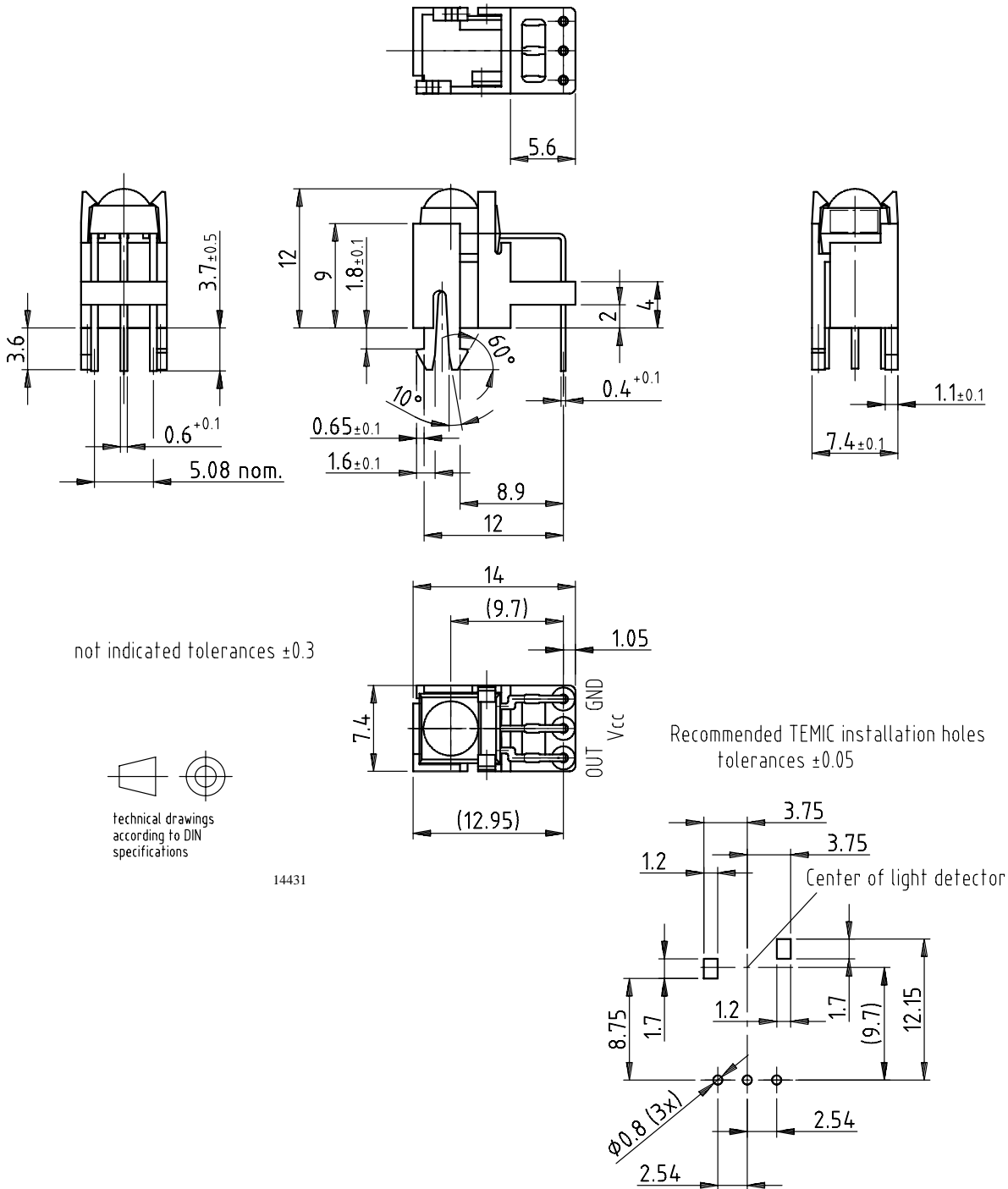

Figure 12. Directivity

Dimensions in mm





Ozone Depleting Substances Policy Statement

It is the policy of **Vishay Semiconductor GmbH** to

1. Meet all present and future national and international statutory requirements.
2. Regularly and continuously improve the performance of our products, processes, distribution and operating systems with respect to their impact on the health and safety of our employees and the public, as well as their impact on the environment.

It is particular concern to control or eliminate releases of those substances into the atmosphere which are known as ozone depleting substances (ODSs).

The Montreal Protocol (1987) and its London Amendments (1990) intend to severely restrict the use of ODSs and forbid their use within the next ten years. Various national and international initiatives are pressing for an earlier ban on these substances.

Vishay Semiconductor GmbH has been able to use its policy of continuous improvements to eliminate the use of ODSs listed in the following documents.

1. Annex A, B and list of transitional substances of the Montreal Protocol and the London Amendments respectively
2. Class I and II ozone depleting substances in the Clean Air Act Amendments of 1990 by the Environmental Protection Agency (EPA) in the USA
3. Council Decision 88/540/EEC and 91/690/EEC Annex A, B and C (transitional substances) respectively.

Vishay Semiconductor GmbH can certify that our semiconductors are not manufactured with ozone depleting substances and do not contain such substances.

We reserve the right to make changes to improve technical design and may do so without further notice.

Parameters can vary in different applications. All operating parameters must be validated for each customer application by the customer. Should the buyer use Vishay-Telefunken products for any unintended or unauthorized application, the buyer shall indemnify Vishay-Telefunken against all claims, costs, damages, and expenses, arising out of, directly or indirectly, any claim of personal damage, injury or death associated with such unintended or unauthorized use.

Vishay Semiconductor GmbH, P.O.B. 3535, D-74025 Heilbronn, Germany
Telephone: 49 (0)7131 67 2831, Fax number: 49 (0)7131 67 2423