

CD74HC251, CD74HCT251

High Speed CMOS Logic 8-Input Multiplexer; Three-State

Features

- Selects One of Eight Binary Data Inputs
- Three-State Output Capability
- True and Complement Outputs
- Typical (Data to Output) Propagation Delay of 14ns at $V_{CC} = 5V$, $C_L = 15pF$, $T_A = 25^\circ C$
- Fanout (Over Temperature Range)
 - Standard Outputs 10 LSTTL Loads
 - Bus Driver Outputs 15 LSTTL Loads
- Wide Operating Temperature Range . . . $-55^\circ C$ to $125^\circ C$
- Balanced Propagation Delay and Transition Times
- Significant Power Reduction Compared to LSTTL Logic ICs
- Alternate Source is Philips
 - HC Types
 - 2V to 6V Operation
 - High Noise Immunity: $N_{IL} = 30\%$, $N_{IH} = 30\%$ of V_{CC} at $V_{CC} = 5V$
- HCT Types
 - 4.5V to 5.5V Operation
 - Direct LSTTL Input Logic Compatibility, $V_{IL} = 0.8V$ (Max), $V_{IH} = 2V$ (Min)
 - CMOS Input Compatibility, $I_I \leq 1\mu A$ at V_{OL} , V_{OH}

Description

The Harris CD74HC251 and CD74HCT251 are 8-channel digital multiplexers with three-state outputs, fabricated with high-speed silicon-gate CMOS technology. Together with the low power consumption of standard CMOS integrated circuits, they possess the ability to drive 10 LSTTL loads. The three-state feature makes them ideally suited for interfacing with bus lines in a bus-oriented system.

This multiplexer features both true (Y) and complement (\bar{Y}) outputs as well as an output enable (\bar{OE}) input. The \bar{OE} must be at a low logic level to enable this device. When the \bar{OE} input is high, both outputs are in the high-impedance state. When enabled, address information on the data select inputs determines which data input is routed to the Y and \bar{Y} outputs. The CD74HCT251 logic family is speed, function, and pin-compatible with the standard 74LS251.

Ordering Information

PART NUMBER	TEMP. RANGE ($^\circ C$)	PACKAGE	PKG. NO.
CD74HC251E	-55 to 125	16 Ld PDIP	E16.3
CD74HCT251E	-55 to 125	16 Ld PDIP	E16.3
CD74HC251M	-55 to 125	16 Ld SOIC	M16.15
CD74HCT251M	-55 to 125	16 Ld SOIC	M16.15

NOTES:

1. When ordering, use the entire part number. Add the suffix 96 to obtain the variant in the tape and reel.
2. Wafer or die for this part number is available which meets all electrical specifications. Please contact your local sales office or Harris customer service for ordering information.

Pinout

CD74HC251, CD74HCT251
(PDIP, SOIC)
TOP VIEW

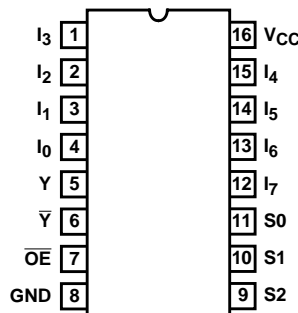

CD74HC251, CD74HCT251

Functional Diagram

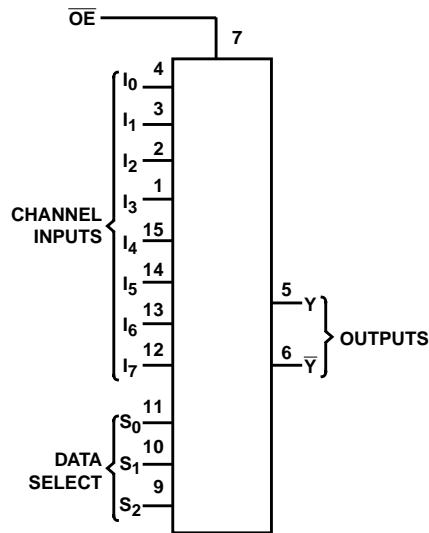

TRUTH TABLE

INPUTS			OUTPUT		
SELECT			OUTPUT CONTROL \overline{OE}	Y	\overline{Y}
S2	S1	S0			
X	X	X	H	Z	Z
L	L	L	L	I_0	$\overline{I_0}$
L	L	H	L	I_1	$\overline{I_1}$
L	H	L	L	I_2	$\overline{I_2}$
L	H	H	L	I_3	$\overline{I_3}$
H	L	L	L	I_4	$\overline{I_4}$
H	L	H	L	I_5	$\overline{I_5}$
H	H	L	L	I_6	$\overline{I_6}$
H	H	H	L	I_7	$\overline{I_7}$

NOTE: H = High Voltage Level, L = Low Voltage Level, X = Don't Care, Z = High Impedance (Off), $I_0, I_1 \dots I_7$ = the level of the respective input.

CD74HC251, CD74HCT251

Absolute Maximum Ratings

DC Supply Voltage, V_{CC}	-0.5V to 7V
DC Input Diode Current, I_{IK}	
For $V_I < -0.5V$ or $V_I > V_{CC} + 0.5V$	$\pm 20mA$
DC Output Diode Current, I_{OK}	
For $V_O < -0.5V$ or $V_O > V_{CC} + 0.5V$	$\pm 20mA$
DC Drain Current, per Output, I_O	
For $-0.5V < V_O < V_{CC} + 0.5V$	$\pm 25mA$
DC Output Source or Sink Current per Output Pin, I_O	
For $V_O > -0.5V$ or $V_O < V_{CC} + 0.5V$	$\pm 25mA$
DC V_{CC} or Ground Current, I_{CC}	$\pm 50mA$

Thermal Information

Thermal Resistance (Typical, Note 3)	θ_{JA} ($^{\circ}C/W$)
PDIP Package	90
SOIC Package	160
Maximum Junction Temperature	$150^{\circ}C$
Maximum Storage Temperature Range	$-65^{\circ}C$ to $150^{\circ}C$
Maximum Lead Temperature (Soldering 10s)	$300^{\circ}C$ (SOIC - Lead Tips Only)

Operating Conditions

Temperature Range (T_A)	$-55^{\circ}C$ to $125^{\circ}C$
Supply Voltage Range, V_{CC}	
HC Types2V to 6V
HCT Types	4.5V to 5.5V
DC Input or Output Voltage, V_I, V_O	0V to V_{CC}
Input Rise and Fall Time	
2V	1000ns (Max)
4.5V	500ns (Max)
6V	400ns (Max)

CAUTION: Stresses above those listed in "Absolute Maximum Ratings" may cause permanent damage to the device. This is a stress only rating and operation of the device at these or any other conditions above those indicated in the operational sections of this specification is not implied.

NOTE:

- θ_{JA} is measured with the component mounted on an evaluation PC board in free air.

DC Electrical Specifications

PARAMETER	SYMBOL	TEST CONDITIONS		V_{CC} (V)	25 $^{\circ}C$			-40 $^{\circ}C$ TO 85 $^{\circ}C$		-55 $^{\circ}C$ TO 125 $^{\circ}C$		UNITS	
		V_I (V)	I_O (mA)		MIN	TYP	MAX	MIN	MAX	MIN	MAX		
HC TYPES													
High Level Input Voltage	V_{IH}	-	-	2	1.5	-	-	1.5	-	1.5	-	V	
				4.5	3.15	-	-	3.15	-	3.15	-	V	
				6	4.2	-	-	4.2	-	4.2	-	V	
Low Level Input Voltage	V_{IL}	-	-	2	-	-	0.5	-	0.5	-	0.5	V	
				4.5	-	-	1.35	-	1.35	-	1.35	V	
				6	-	-	1.8	-	1.8	-	1.8	V	
High Level Output Voltage CMOS Loads	V_{OH}	V_{IH} or V_{IL}	-0.02	-0.02	2	1.9	-	-	1.9	-	1.9	-	V
			-0.02	-0.02	4.5	4.4	-	-	4.4	-	4.4	-	V
			-0.02	-0.02	6	5.9	-	-	5.9	-	5.9	-	V
High Level Output Voltage TTL Loads	V_{OH}	V_{IH} or V_{IL}	-	-	-	-	-	-	-	-	-	V	
			-4	-4	4.5	3.98	-	-	3.84	-	3.7	-	V
			-5.2	-5.2	6	5.48	-	-	5.34	-	5.2	-	V
Low Level Output Voltage CMOS Loads	V_{OL}	V_{IH} or V_{IL}	0.02	0.02	2	-	-	0.1	-	0.1	-	0.1	V
			0.02	0.02	4.5	-	-	0.1	-	0.1	-	0.1	V
			0.02	0.02	6	-	-	0.1	-	0.1	-	0.1	V
Low Level Output Voltage TTL Loads	V_{OL}	V_{IH} or V_{IL}	-	-	-	-	-	-	-	-	-	V	
			4	4	4.5	-	-	0.26	-	0.33	-	0.4	V
			5.2	5.2	6	-	-	0.26	-	0.33	-	0.4	V

CD74HC251, CD74HCT251

DC Electrical Specifications (Continued)

PARAMETER	SYMBOL	TEST CONDITIONS		V _{CC} (V)	25°C			-40°C TO 85°C		-55°C TO 125°C		UNITS
		V _I (V)	I _O (mA)		MIN	TYP	MAX	MIN	MAX	MIN	MAX	
Input Leakage Current	I _I	V _{CC} or GND	-	6	-	-	±0.1	-	±1	-	±1	μA
Quiescent Device Current	I _{CC}	V _{CC} or GND	0	6	-	-	8	-	80	-	160	μA
Three-State Leakage Current	-	V _{IL} or V _{IH}	V _O = V _{CC} or GND	6	-	-	±0.5	-	±5.0	-	±10	μA
HCT TYPES												
High Level Input Voltage	V _{IH}	-	-	4.5 to 5.5	2	-	-	2	-	2	-	V
Low Level Input Voltage	V _{IL}	-	-	4.5 to 5.5	-	-	0.8	-	0.8	-	0.8	V
High Level Output Voltage CMOS Loads	V _{OH}	V _{IH} or V _{IL}	-0.02	4.5	4.4	-	-	4.4	-	4.4	-	V
High Level Output Voltage TTL Loads			-4	4.5	3.98	-	-	3.84	-	3.7	-	V
Low Level Output Voltage CMOS Loads	V _{OL}	V _{IH} or V _{IL}	0.02	4.5	-	-	0.1	-	0.1	-	0.1	V
Low Level Output Voltage TTL Loads			4	4.5	-	-	0.26	-	0.33	-	0.4	V
Input Leakage Current	I _I	V _{CC} and GND	0	5.5	-	-	±0.1	-	±1	-	±1	μA
Quiescent Device Current	I _{CC}	V _{CC} or GND	0	5.5	-	-	8	-	80	-	160	μA
Three-State Leakage Current	-	V _{IL} or V _{IH}	V _O = V _{CC} or GND	6	-	-	±0.5	-	±5.0	-	±10	μA
Additional Quiescent Device Current Per Input Pin: 1 Unit Load	ΔI _{CC}	V _{CC} -2.1	-	4.5 to 5.5	-	100	360	-	450	-	490	μA

NOTE: For dual-supply systems theoretical worst case (V_I = 2.4V, V_{CC} = 5.5V) specification is 1.8mA.

HCT Input Loading Table

INPUT	UNIT LOADS
S0, S1, S2	0.55
I0 - I7	0.5
OE	2.65

NOTE: Unit Load is ΔI_{CC} limit specified in DC Electrical Table, e.g., 360μA max at 25°C.

CD74HC251, CD74HCT251

Switching Specifications Input $t_r, t_f = 6\text{ns}$

PARAMETER	SYMBOL	TEST CONDITIONS	V_{CC} (V)	25°C			-40°C TO 85°C		-55°C TO 125°C		UNITS
				MIN	TYP	MAX	MIN	MAX	MIN	MAX	
HC TYPES											
Propagation Delay Select to Outputs	t_{PLH}, t_{PHL}	$C_L = 50\text{pF}$	2	-	-	245	-	305	-	370	ns
			4.5	-	-	49	-	61	-	74	ns
		$C_L = 15\text{pF}$	5	-	21	-	-	-	-	-	ns
		$C_L = 50\text{pF}$	6	-	-	42	-	52	-	63	ns
Data to Outputs	t_{PLH}, t_{PHL}	$C_L = 50\text{pF}$	2	-	-	175	-	220	-	265	ns
			4.5	-	-	35	-	44	-	53	ns
		$C_L = 15\text{pF}$	5	-	12	-	-	-	-	-	ns
		$C_L = 50\text{pF}$	6	-	-	30	-	37	-	45	ns
Enable to High Z and Enable from High Z	t_{PLH}, t_{PHL}	$C_L = 50\text{pF}$	2	-	-	140	-	175	-	210	ns
			4.5	-	-	28	-	35	-	42	ns
		$C_L = 15\text{pF}$	5	-	11	-	-	-	-	-	ns
		$C_L = 50\text{pF}$	6	-	-	24	-	30	-	36	ns
Output Transition Time	t_{TLH}, t_{THL}	$C_L = 50\text{pF}$	2	-	-	75	-	95	-	110	ns
			4.5	-	-	15	-	19	-	22	ns
			6	-	-	13	-	16	-	19	ns
Input Capacitance	C_{IN}	-	-	-	10	-	10	-	10	pF	
Three-State Output Capacitance	C_O	-	-	-	15	-	15	-	15	pF	
Power Dissipation Capacitance (Notes 4, 5)	C_{PD}	-	5	-	60	-	-	-	-	pF	
HCT TYPES											
Propagation Delay Select to Outputs	t_{PLH}, t_{PHL}	$C_L = 50\text{pF}$	4.5	-	-	42	-	53	-	63	ns
		$C_L = 15\text{pF}$	5	-	18	-	-	-	-	-	ns
Data to Outputs	t_{PLH}, t_{PHL}	$C_L = 50\text{pF}$	4.5	-	-	35	-	44	-	53	ns
		$C_L = 15\text{pF}$	5	-	12	-	-	-	-	-	ns
Enable to High Z and Enable from High Z	t_{PLH}, t_{PHL}	$C_L = 50\text{pF}$	4.5	-	-	30	-	38	-	45	ns
		$C_L = 15\text{pF}$	5	-	12	-	-	-	-	-	ns
Output Transition Time	t_{TLH}, t_{THL}	$C_L = 50\text{pF}$	4.5	-	-	15	-	19	-	22	ns
Input Capacitance	C_{IN}	-	-	-	10	-	10	-	10	pF	
Power Dissipation Capacitance (Notes 4, 5)	C_{PD}	-	5	-	60	-	-	-	-	pF	

NOTES:

4. C_{PD} is used to determine the dynamic power consumption, per package.
5. $P_D = V_{CC}^2 f_i (C_{PD} + C_L)$ where f_i = input frequency, C_L = output load capacitance, V_{CC} = supply voltage.

Test Circuits and Waveforms

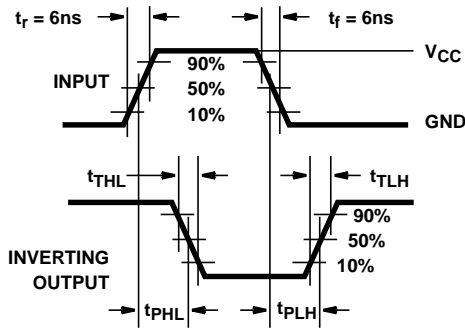

FIGURE 1. HC TRANSITION TIMES AND PROPAGATION DELAY TIMES, COMBINATION LOGIC

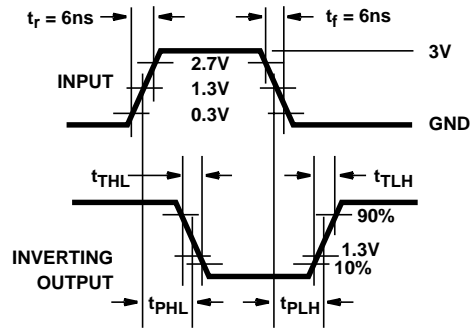

FIGURE 2. HCT TRANSITION TIMES AND PROPAGATION DELAY TIMES, COMBINATION LOGIC

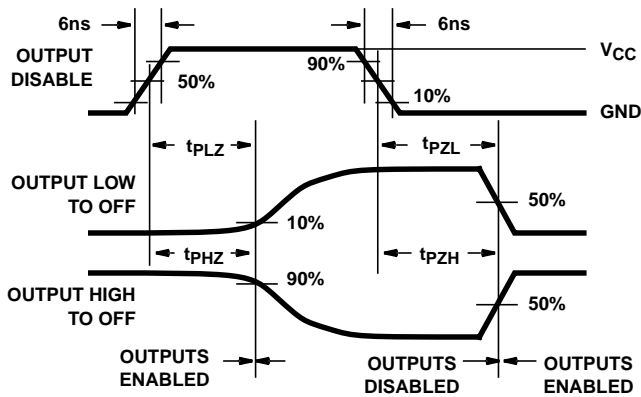

FIGURE 3. HC THREE-STATE PROPAGATION DELAY WAVEFORM

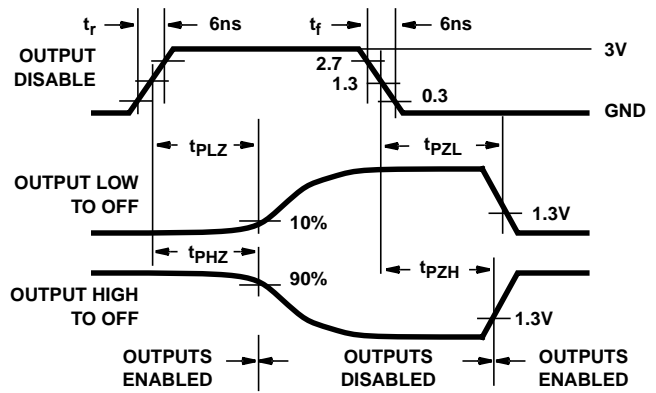
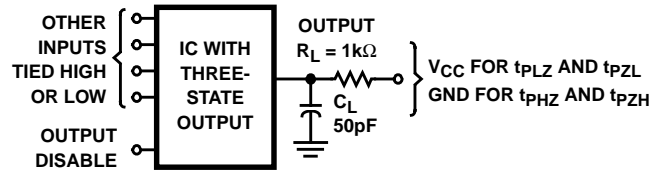

FIGURE 4. HCT THREE-STATE PROPAGATION DELAY WAVEFORM



NOTE: Open drain waveforms t_{PLZ} and t_{PZL} are the same as those for three-state shown on the left. The test circuit is Output $R_L = 1k\Omega$ V_{CC} , $C_L = 50pF$.

FIGURE 5. HC AND HCT THREE-STATE PROPAGATION DELAY TEST CIRCUIT

IMPORTANT NOTICE

Texas Instruments and its subsidiaries (TI) reserve the right to make changes to their products or to discontinue any product or service without notice, and advise customers to obtain the latest version of relevant information to verify, before placing orders, that information being relied on is current and complete. All products are sold subject to the terms and conditions of sale supplied at the time of order acknowledgement, including those pertaining to warranty, patent infringement, and limitation of liability.

TI warrants performance of its semiconductor products to the specifications applicable at the time of sale in accordance with TI's standard warranty. Testing and other quality control techniques are utilized to the extent TI deems necessary to support this warranty. Specific testing of all parameters of each device is not necessarily performed, except those mandated by government requirements.

CERTAIN APPLICATIONS USING SEMICONDUCTOR PRODUCTS MAY INVOLVE POTENTIAL RISKS OF DEATH, PERSONAL INJURY, OR SEVERE PROPERTY OR ENVIRONMENTAL DAMAGE ("CRITICAL APPLICATIONS"). TI SEMICONDUCTOR PRODUCTS ARE NOT DESIGNED, AUTHORIZED, OR WARRANTED TO BE SUITABLE FOR USE IN LIFE-SUPPORT DEVICES OR SYSTEMS OR OTHER CRITICAL APPLICATIONS. INCLUSION OF TI PRODUCTS IN SUCH APPLICATIONS IS UNDERSTOOD TO BE FULLY AT THE CUSTOMER'S RISK.

In order to minimize risks associated with the customer's applications, adequate design and operating safeguards must be provided by the customer to minimize inherent or procedural hazards.

TI assumes no liability for applications assistance or customer product design. TI does not warrant or represent that any license, either express or implied, is granted under any patent right, copyright, mask work right, or other intellectual property right of TI covering or relating to any combination, machine, or process in which such semiconductor products or services might be or are used. TI's publication of information regarding any third party's products or services does not constitute TI's approval, warranty or endorsement thereof.