

SANYO

No. 5180

STK405-090

2ch AF Power Amplifier (Split Power Supply)
50W + 50W min, THD = 10%

Overview

The STK405-090, a member of the STK405-000 series, is a low-cost, 2-channel audio power amplifier hybrid IC that is ideal for a wide range of stereo sets. It has dedicated 6Ω output drive, in contrast with the STK401-000 series which supports $6\Omega/3\Omega$ output drive.

Features

- Class B amplifiers
- Output load impedance $R_L = 6\Omega$ support
- EIAJ-output compatible ($f = 1\text{kHz}$, THD = 10%)
- Low supply switching shock noise
- Pin assignment grouped into individual blocks of inputs, outputs and supply lines to minimize the adverse effects of pattern layout on operating characteristics
- External bootstrap circuit not necessary
- Standby operation possible using external circuit
- Voltage gain $V_G = 26\text{dB}$ for easy gain distribution within the set
- Member of 10W/ch to 80W/ch pin-compatible series

Series Organization

The following devices form a series with differing output capacity. Some of the following devices are under development. Contact your Sanyo sales representative if you require more detailed information.

Type No.	Output power	Supply voltage [V]	
		$V_{CC\text{ max}}$	V_{CC}
STK405-010	10W + 10W	± 26.0	± 14.0
STK405-030	20W + 20W	± 30.5	± 18.5
STK405-050	30W + 30W	± 34.5	± 22.0
STK405-070	40W + 40W	± 39.0	± 25.0
STK405-090	50W + 50W	± 42.0	± 26.5
STK405-100	60W + 60W	± 45.0	± 29.0
STK405-110	70W + 70W	± 50.0	± 31.0
STK405-120	80W + 80W	± 52.5	± 33.0

Package Dimensions

unit: mm

4158

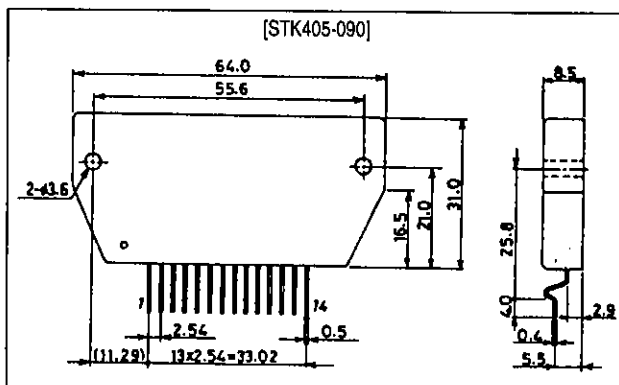

Specifications

Maximum Ratings at $T_a = 25^\circ\text{C}$

Parameter	Symbol	Conditions	Ratings	Unit
Maximum supply voltage	$V_{CC \text{ max}}$		± 42	V
Thermal resistance	θ_{j-c}	Per power transistor	2.7	$^\circ\text{C/W}$
Junction temperature	T_J		150	$^\circ\text{C}$
Operating substrate temperature	T_c		125	$^\circ\text{C}$
Storage temperature	T_{stg}		-30 to +125	$^\circ\text{C}$
Available time for load short-circuit	t_s	$V_{CC} = \pm 26.5\text{V}$, $R_L = 6\Omega$, $f = 50\text{Hz}$, $P_O = 50\text{W}$	1	s

Operating Characteristics at $T_a = 25^\circ\text{C}$, $R_L = 6\Omega$ (noninductive load), $R_g = 600\Omega$, $V_G = 26\text{dB}$

Parameter	Symbol	Conditions	min	typ	max	Unit
Quiescent current	I_{CCO}	$V_{CC} = \pm 34.0\text{V}$, no load	-	12	20	mA
Output power	P_O	$V_{CC} = \pm 26.5\text{V}$, $f = 1\text{kHz}$, $\text{THD} = 10.0\%$	50	-	-	W
Total harmonic distortion	THD	$V_{CC} = \pm 26.5\text{V}$, $f = 1\text{kHz}$, $P_O = 5.0\text{W}$	-	0.04	0.1	%
Frequency response	f_L, f_H	$V_{CC} = \pm 26.5\text{V}$, $P_O = 1.0\text{W}$, $_{-3}^{+0}\text{dB}$	-	20 to 50k	-	Hz
Input impedance	r_i	$V_{CC} = \pm 26.5\text{V}$, $f = 1\text{kHz}$, $P_O = 1.0\text{W}$	-	55	-	$\text{k}\Omega$
Output noise voltage	V_{NO}	$V_{CC} = \pm 34.0\text{V}$, $R_g = 10\text{k}\Omega$	-	-	1.2	mVrms
Neutral voltage	V_N	$V_{CC} = \pm 34.0\text{V}$	-100	0	+100	mV

Notes.

All tests are measured using a regulated voltage supply unless otherwise specified.

Available time for load short-circuit and output noise voltage are measured using the transformer supply specified below.

The output noise voltage is the peak value of an average-reading meter with an rms value scale (VTVM). A regulated AC supply (50Hz) should be used to eliminate the effects of AC primary line flicker noise.

Specified Transformer Supply (RP-25 or Equivalent)

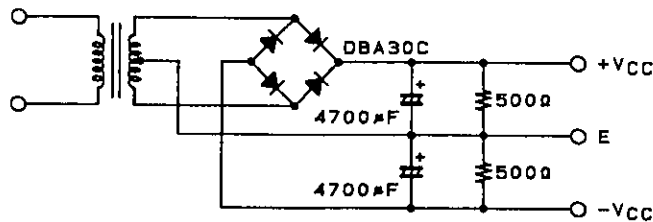

A04163

From expression (1): $\theta_{c-a} < (125 - 50)/34.5 < 2.17$

From expression (2): $\theta_{c-a} < (150 - 50)/34.5 - 2.7/4 < 2.22$

Therefore, to satisfy both expressions, the required heat-sink must have a thermal resistance less than $2.17^\circ\text{C}/\text{W}$.

This heatsink design example is based on a constant-voltage supply, and should be verified within your specific set environment.

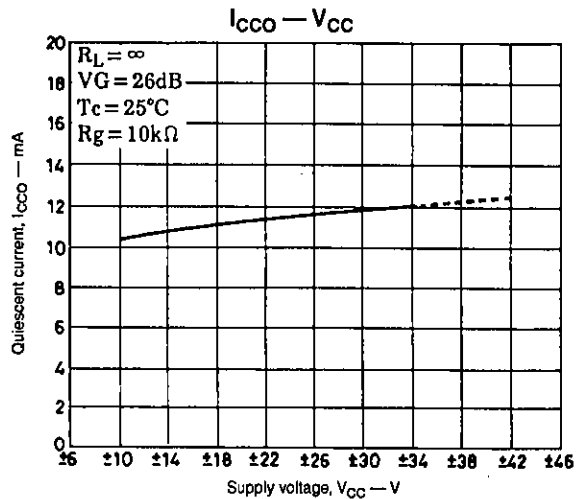
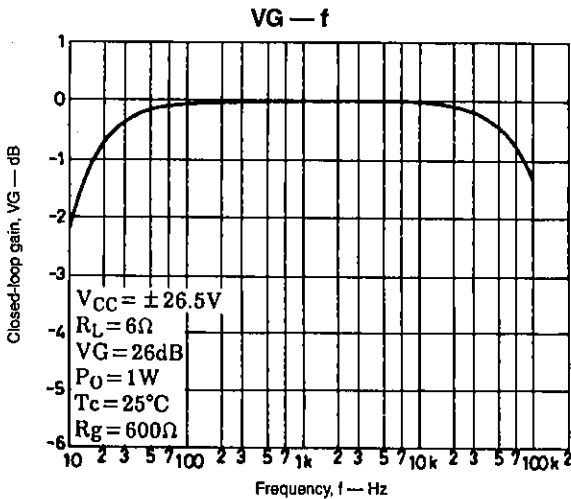
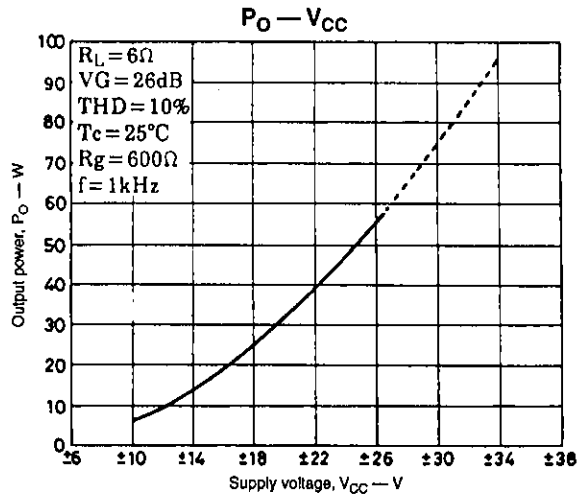
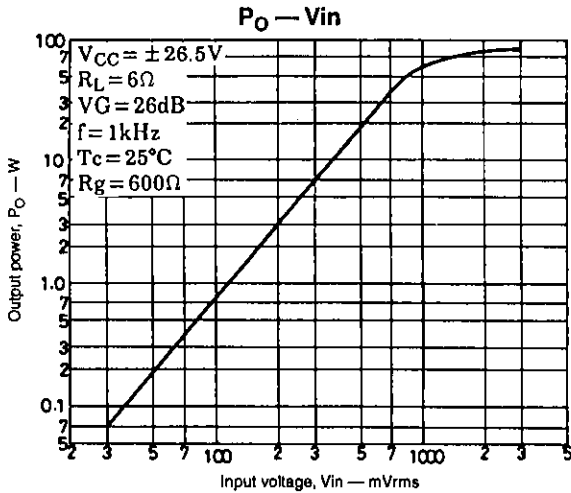
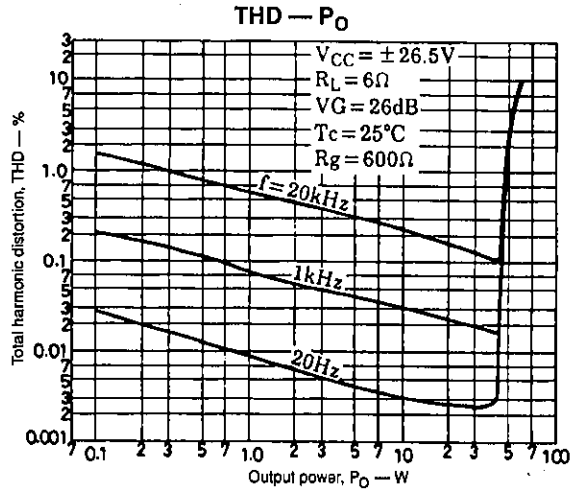
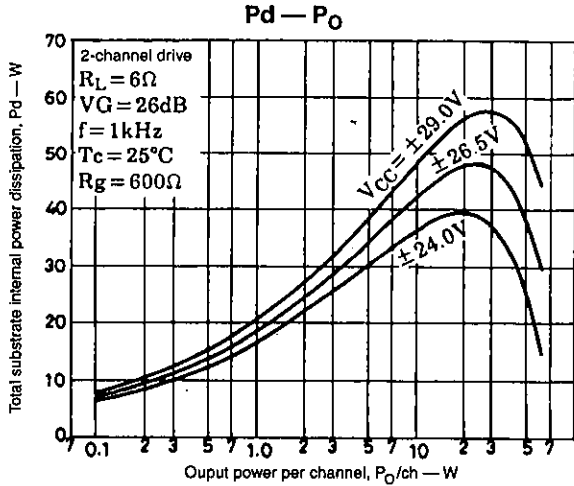

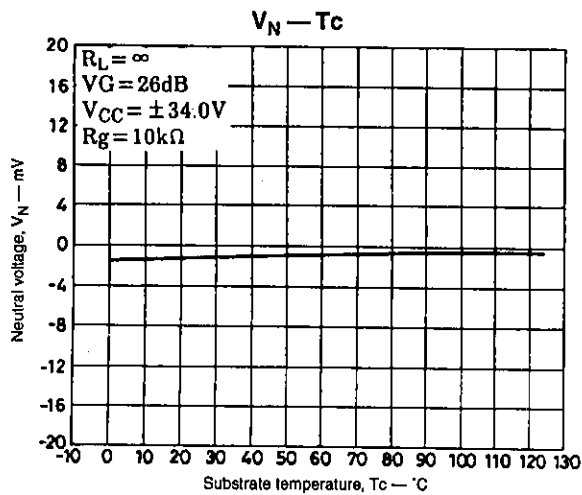
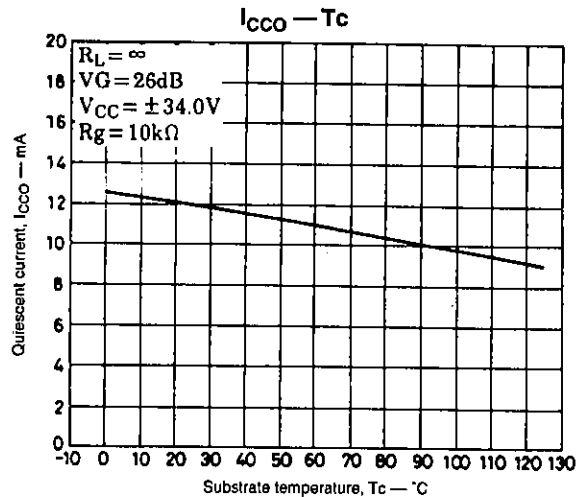
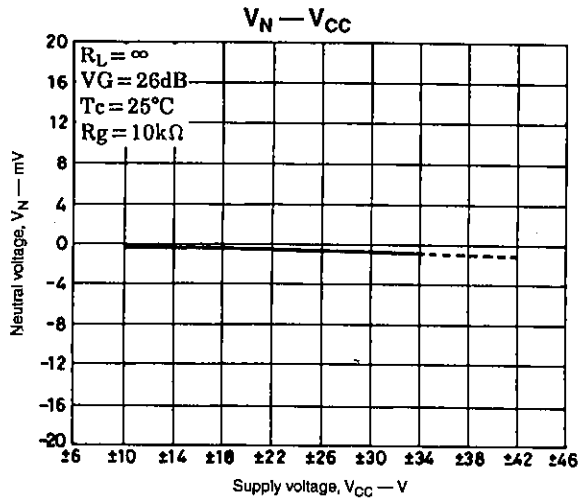

- No products described or contained herein are intended for use in surgical implants, life-support systems, aerospace equipment, nuclear power control systems, vehicles, disaster/crime-prevention equipment and the like, the failure of which may directly or indirectly cause injury, death or property loss.
- Anyone purchasing any products described or contained herein for an above-mentioned use shall:
 - ① Accept full responsibility and indemnify and defend SANYO ELECTRIC CO., LTD., its affiliates, subsidiaries and distributors and all their officers and employees, jointly and severally, against any and all claims and litigation and all damages, cost and expenses associated with such use;
 - ② Not impose any responsibility for any fault or negligence which may be cited in any such claim or litigation on SANYO ELECTRIC CO., LTD., its affiliates, subsidiaries and distributors or any of their officers and employees, jointly or severally.
- Information (including circuit diagrams and circuit parameters) herein is for example only; it is not guaranteed for volume production. SANYO believes information herein is accurate and reliable, but no guarantees are made or implied regarding its use or any infringements of intellectual property rights or other rights of third parties.

This catalog provides information as of October, 1995. Specifications and information herein are subject to change without notice.