

STA341M

Silicon NPN, PNP Triple Diffused Planar

Maximum Ratings

(Ta = 25°C)

Item	Symbol	Ratings		Unit
		NPN	PNP	
Collector-to-Base Voltage	V _{CB0}	30	-30	V
Collector-to-Emitter Voltage	V _{CEO}	30	-30	V
Emitter-to-Base Voltage	V _{EBO}	6	-6	V
Collector Current	I _c	1	-1	A
Base Current	I _B	0.1	-0.1	A
Total Power Dissipation	P _T	2.2 (Ta = 25°C)		W
Operating Junction Temperature	T _J	150		°C
Storage Temperature	T _{stg}	-40 ~ +150		°C

Electrical Characteristics

(Ta = 25°C)

Item	Symbol	Conditions	NPN			PNP			Unit
			Specification			Specification			
			min	typ	max	min	typ	max	
Collector Cut-off Current	I _{cBO}	V _{CB} = -30V			10	V _{CB} = -30V			μA
Emitter Cut-off Current	I _{EBO}	V _{EB} = 6V			10	V _{EB} = -6V			mA
Collector-to-Emitter Voltage	V _{CEO}	I _c = 10mA	30			I _c = -10mA	-30		V
DC Forward Current Transfer Ratio	h _{FE}	V _{CE} = 4V, I _c = 0.3A	100			V _{CE} = -4V, I _c = -0.3A	100		
Collector-to-Emitter Saturation Voltage	V _{CE(sat)}	I _c = 300mA, I _B = 10mA			0.5	I _c = -300mA, I _B = -10mA			-0.5 V
Turn on Time	t _{on}	I _c = 0.3A I _{B1} = -I _{B2} = 10mA		0.22		I _c = -0.3A I _{B1} = -I _{B2} = -10mA		0.25	μs
Storage Time	t _{stg}			1.4				0.54	μs
Fall Time	t _f			0.28				0.3	μs

Equivalent Circuit Diagram

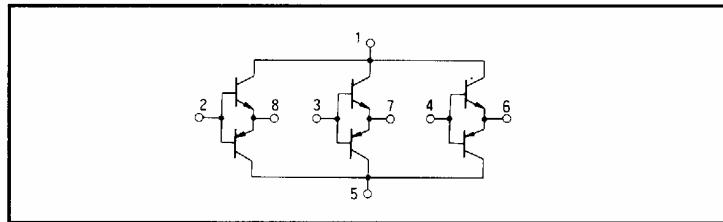

Characteristic Curves

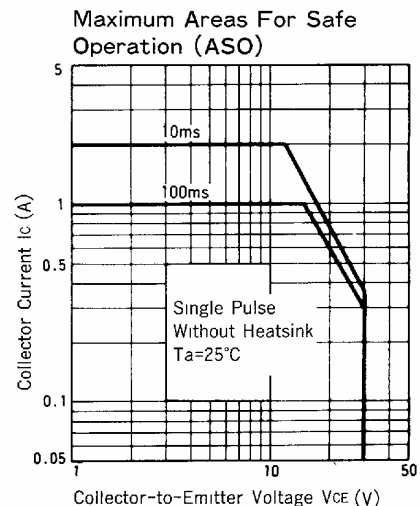
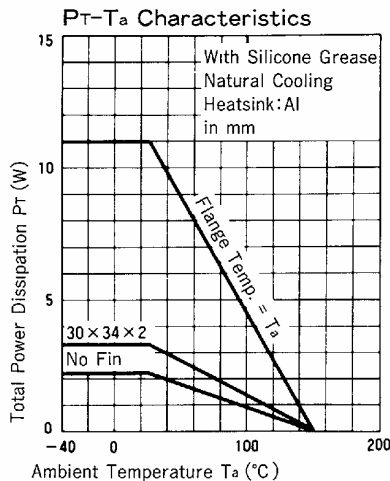

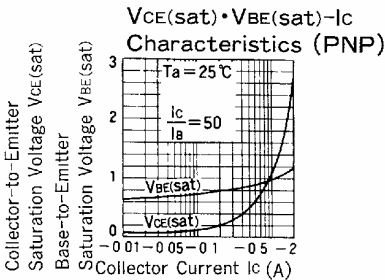
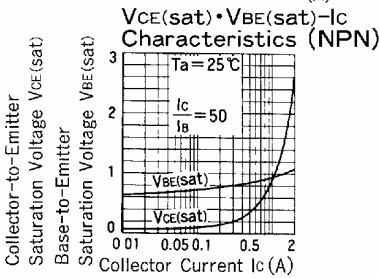
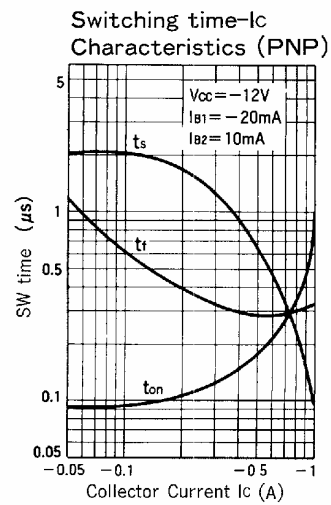
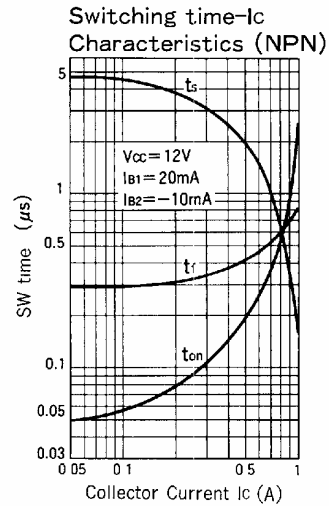
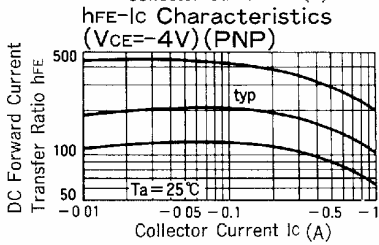
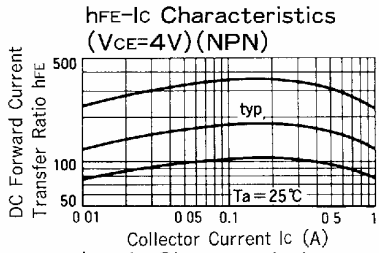
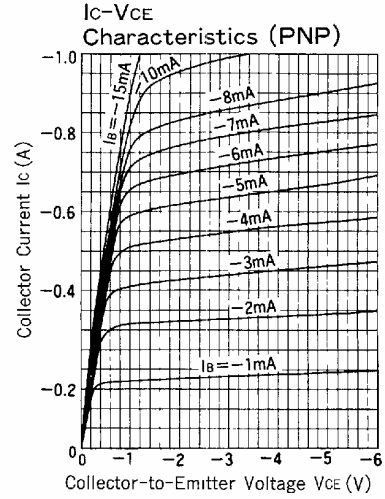
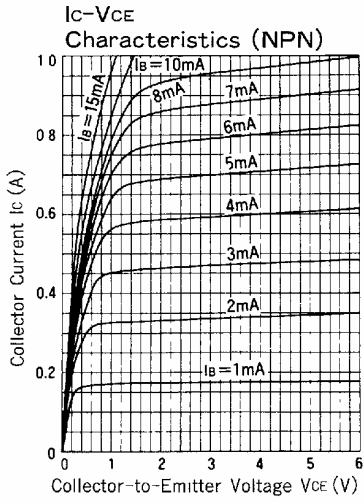

Notes on using products

Outline Drawings (Unit:in mm)

STA Family

STA300 Series

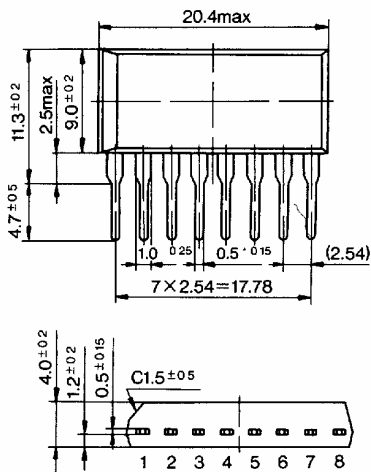

Weight Approx. 2.0g

STA400 Series

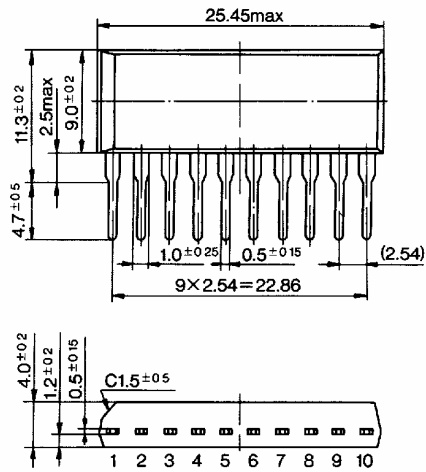

Weight Approx. 2.6g

SMA Family

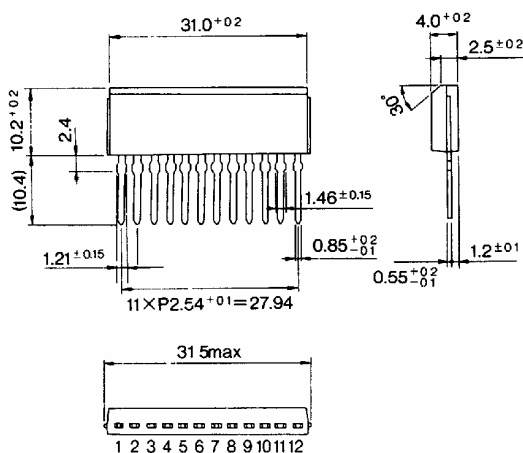

Weight Approx. 4.0g

SLA Family

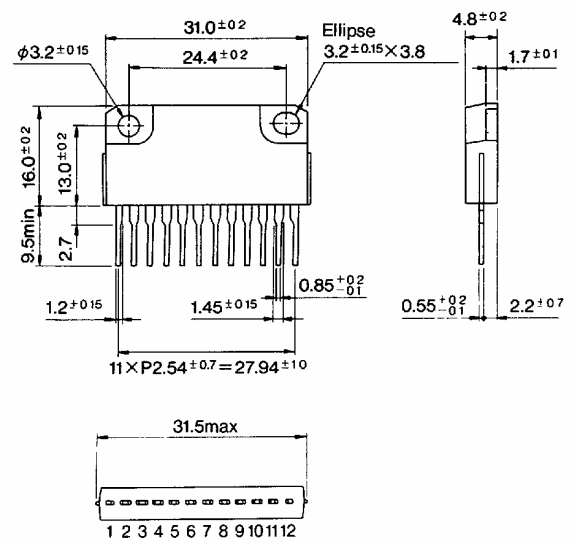

Weight Approx. 6.0g