

DUAL EQUALIZER AMPLIFIER SYSTEM

The KA2228 is a monolithic integrated circuit consisting of play back AMP, REC AMP with ALC, mic AMP with ALC and monitor AMP. It is dual EQ AMP system built-in switch for selecting REC/PLAY mode, tape or radio (Aux) modes. It is used for radio cassette players and can be applied easily by getting rid of the conventional mechanism REC/PLAY switch.

FEATURES

- Following 4 modes can be operated by a combination of external switches: radio (Aux), radio (Aux) recording, mic recording and tape play back
- Built-in switch for selecting REC/PLAY mode.
- Built-in switch for selecting radio (Aux) or tape input.
- Few external parts.
- Small package: 21 shrink ZSIP type.
- Operating supply voltage range: $V_{CC} = 3.5 \sim 7.0V$

21 ZSIP

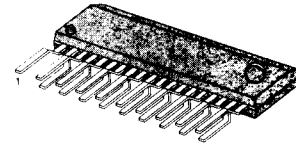

ORDERING INFORMATION

Device	Package	Operating Temperature
KA2228	21 ZSIP	-25°C ~ +75°C

BLOCK DIAGRAM

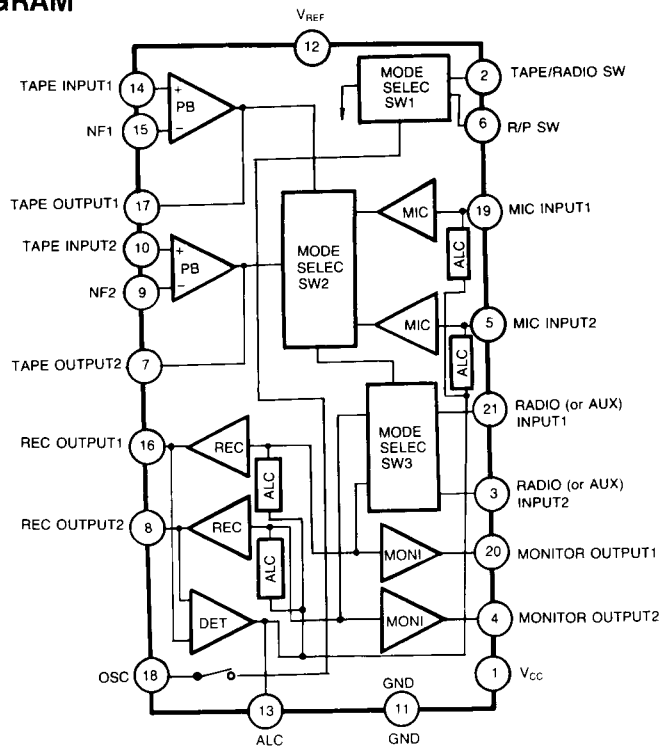

Fig. 1

ABSOLUTE MAXIMUM RATINGS ($T_a = 25^\circ\text{C}$)

Characteristic	Symbol	Value	Unit
Supply Voltage	V_{CC}	8	V
Power Dissipation	P_D	750	mW
Operating Temperature	T_{OPR}	-25 ~ +75	$^\circ\text{C}$
Storage Temperature	T_{STG}	-55 ~ +155	$^\circ\text{C}$

ELECTRICAL CHARACTERISTICS($T_a = 25^\circ\text{C}$, $V_{CC} = 5\text{V}$, $f = 1\text{KHz}$, unless otherwise specified)

Characteristic	Symbol	Test Conditions	Min	Typ	Max	Unit
Quiescent Circuit Current	I_{CCQ1}	Radio, $V_i = 0$	7	10	14	mA
	I_{CCQ2}	Radio REC, $V_i = 0$	10	13	16	mA
	I_{CCQ3}	Tape PB, $V_i = 0$	7	10	14	mA
	I_{CCQ4}	Mic REC, $V_i = 0$	6	9	12	mA
Reference Voltage	V_{REF}		1.8	2.0	2.3	V
MONITOR AMP						
Voltage Gain	G_{V1}	$V_i = -50\text{dBv}$	14	16	18	dB
Output Voltage	V_{O1}	THD = 1%	1.0	1.3		V
Total Harmonic Distortion	THD ₁	$V_o = -10\text{dBv}$		0.06	0.2	%
Output Noise Voltage	V_{NO1}	Audio Band		14	30	μV
Cross Talk	CT ₁	$V_o = 0\text{dBv}$	45	60		dB
Ripple Rejection Ratio	RR ₁	$V_R = -20\text{dBv}$, $f = 120\text{Hz}$		50		dB
PLAY BACK AMP						
Closed Loop Voltage Gain	G_{VC}	$V_i = -50\text{dBv}$	35	38	41	dB
Output Voltage	G_{VO}	$V_i = -90\text{dBv}$	70	78		dB
Maximum Output Voltage	V_{O2}	THD = 1%	1.0	1.3		V
Total Harmonic Distortion	THD ₂	$V_o = -10\text{dBv}$		0.02		%
Output Noise Voltage	V_{NO2}	Audio Band		80	150	μV
Cross Talk	CT ₂	$V_o = 0\text{dBv}$	55	65		dB
Ripple Rejection Ratio	RR ₂	$V_R = -20\text{dBv}$ $f = 120\text{Hz}$	-34	-42		dB

ELECTRICAL CHARACTERISTICS (Continued)

Characteristic	Symbol	Test Conditions	Min	Typ	Max	Unit
RECORDING AMP						
Voltage Gain	G_{V2}	$V_i = -50\text{dBv}$	24	27	30	dB
Total Harmonic Distortion	THD_3	$V_o = -10\text{dBv}$		0.04		%
Output Noise Voltage	$V_{\text{NO}3}$	Audio Band		120	250	μV
Cross Talk	CT_3	$V_o = -10\text{dBv}$, Audio Band	55	65		dB
Ripple Rejection Ratio	RR_3	$V_R = -20\text{dBv}$, $f = 120\text{Hz}$	-34	-42		dB
ALC Voltage	$V_{\text{O(ALC)1}}$	$V_i = -20\text{dBv}$	-4.4	-2.7	0	dBv
ALC Voltage	$V_{\text{O(ALC)2}}$	$V_i = -15\text{dBv}$	-4.2	-2.5	0.2	dBv
ALC Voltage	$V_{\text{O(ALC)3}}$	$V_i = -5\text{dBv}$	-4.0	-2.2	0.5	dBv
MIC + REC AMP						
Voltage Gain	G_{V3}	$V_i = -80\text{dBv}$	60	63	66	dB
Total Harmonic Distortion	THD_4	$V_o = -10\text{dBv}$		0.7	2.0	%
Output Noise Voltage	$V_{\text{NO}4}$	Audio Band		3.5	7.0	mV
Cross Talk	CT_4	$V_o = -10\text{dBv}$	30	43		dB
Ripple Rejection Ratio	RR_4	$V_R = -20\text{dBv}$, $f = 120\text{Hz}$	13	20		dB
ALC Voltage	$V_{\text{O(ALC)4}}$	$V_i = -60\text{dBv}$	-4.0	-2.0	0.5	dBv
ALC Voltage	$V_{\text{O(ALC)5}}$	$V_i = -40\text{dBv}$	-4.0	-2.0	0.5	dBv
ALC Voltage	$V_{\text{O(ALC)6}}$	$V_i = -10\text{dBv}$	-4.0	-2.0	0.5	dBv

TEST CIRCUIT

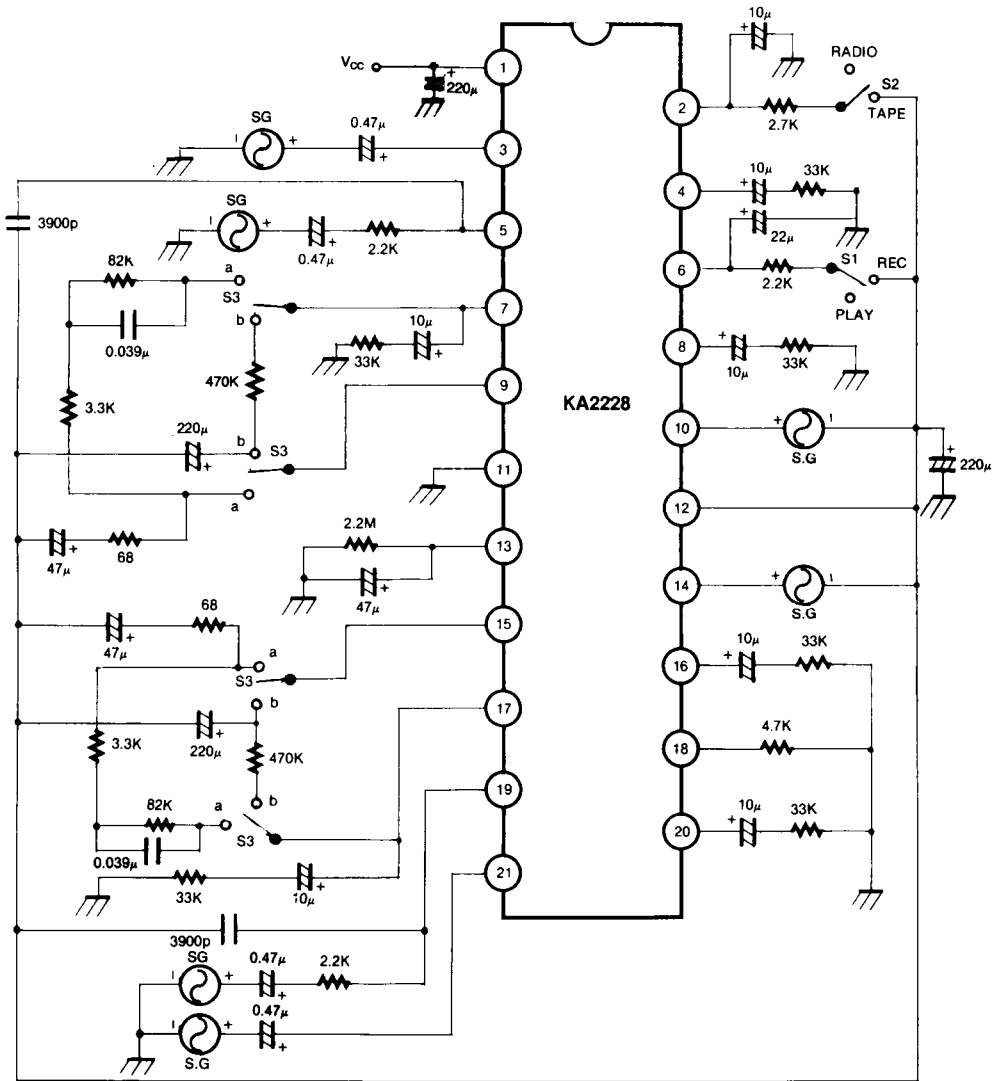

Fig. 2

OPERATION MODE BY EXTERNAL SWITCHES (S1, S2) COMBINATION

CIRCUIT BLOCK	S1 S2	S1 = REC		S1 = PLAY	
		S2 = RADIO	S2 = TAPE	S2 = RADIO	S2 = TAPE
MIC AMP		ON	ON	OFF	OFF
PB AMP		OFF	OFF	ON	ON
REC AMP		ON	ON	OFF	OFF
MONITOR AMP		ON	OFF	ON	ON
SMP		M	M	P	P
STR		R	T	R	T
SRE		ON	ON	OFF	OFF
OPERATION MODE		RADIO REC	MIC REC	RADIO PLAY	TAPE PLAY BACK



OUTPUT VOLTAGE-INPUT VOLTAGE

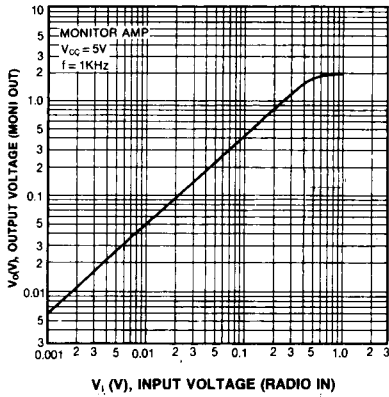

TOTAL HARMONIC DISTORTION-OUTPUT VOLTAGE

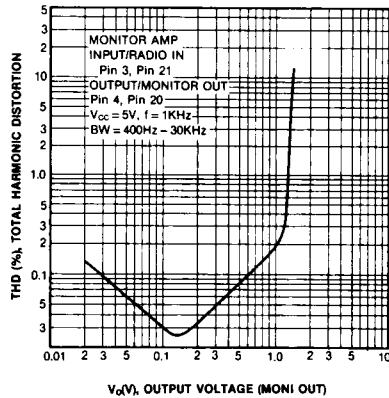

OUTPUT VOLTAGE-INPUT VOLTAGE

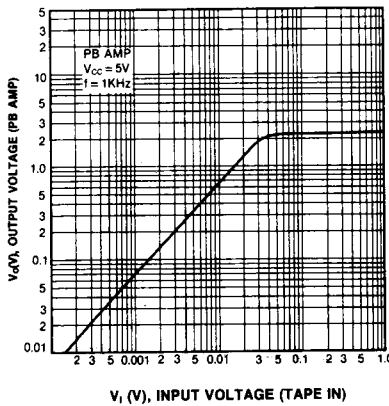

TOTAL HARMONIC DISTORTION-OUTPUT VOLTAGE

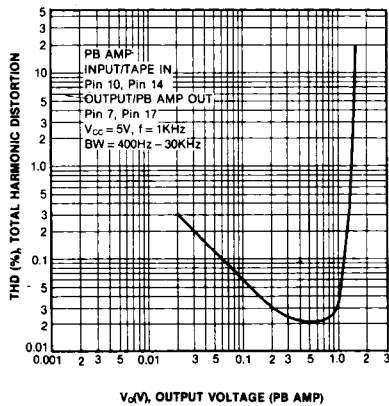

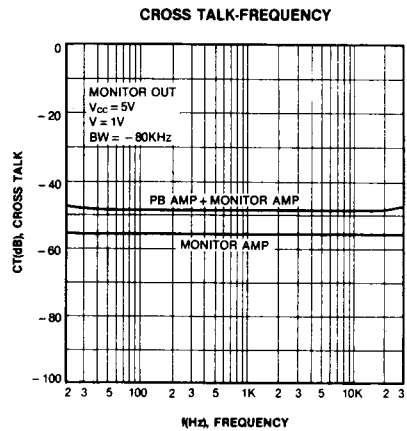
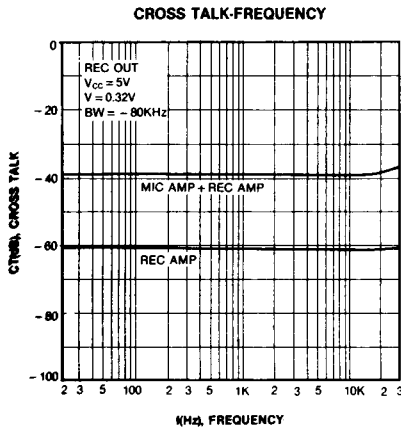
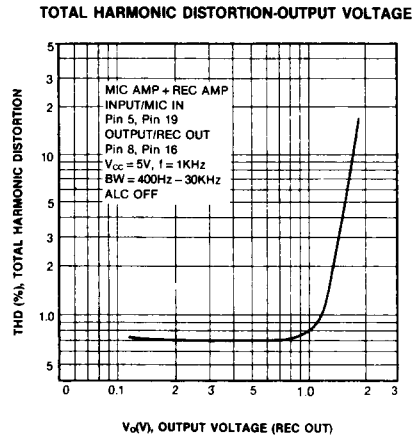
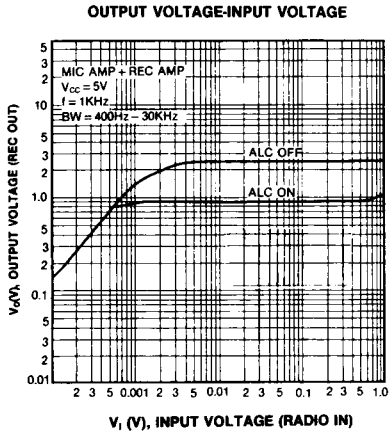
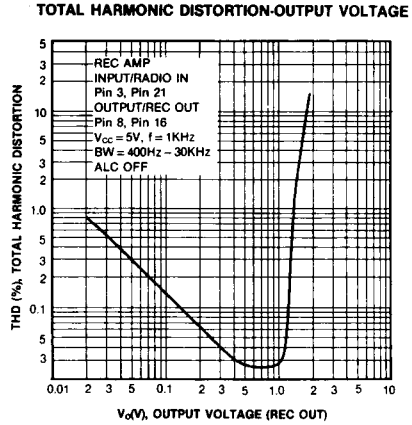
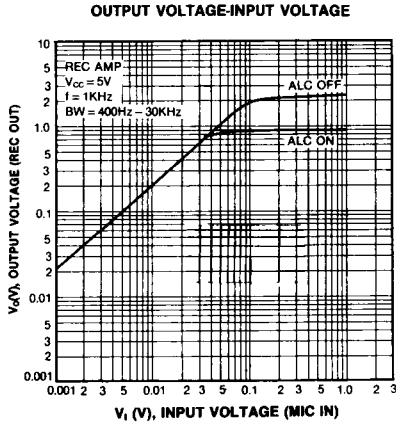

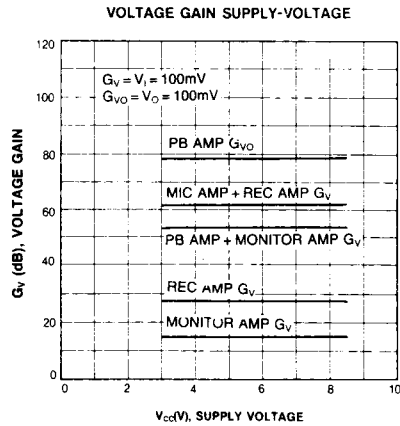
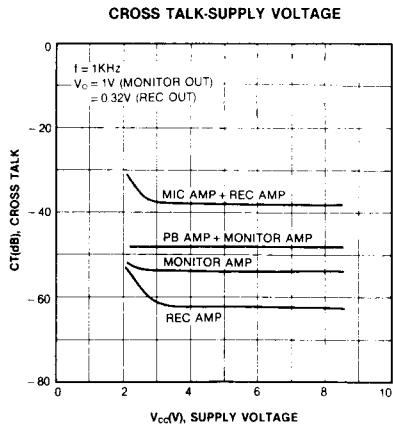
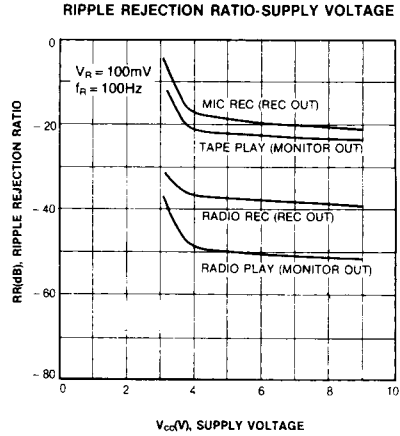
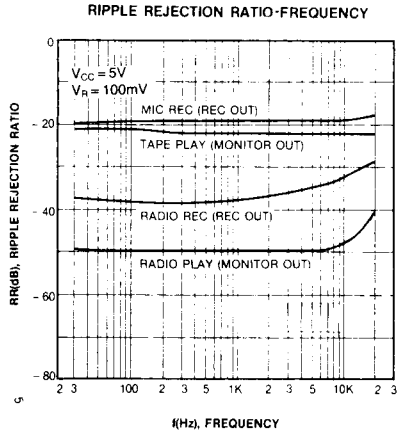
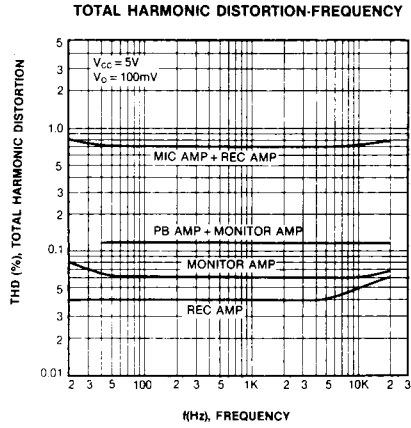
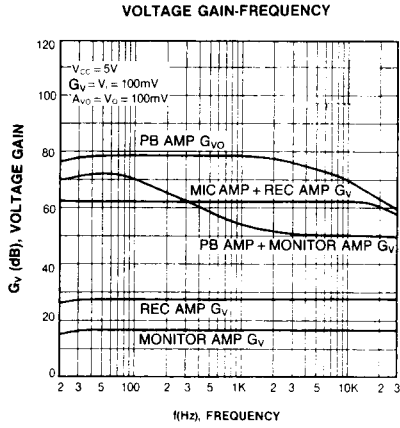

QUIESCENT CIRCUIT CURRENT
- AMBIENT TEMPERATURE

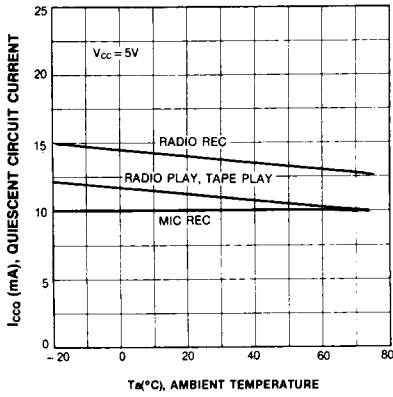

PIN 12, 18 VOLTAGE-AMBIENT TEMPERATURE

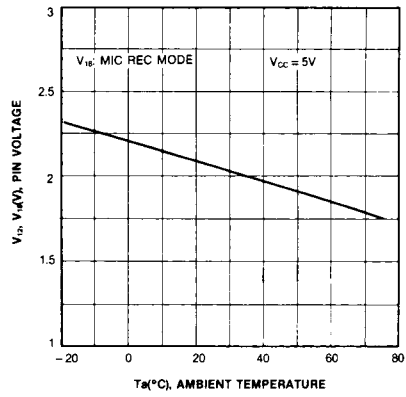

VOLTAGE GAIN AMBIENT TEMPERATURE

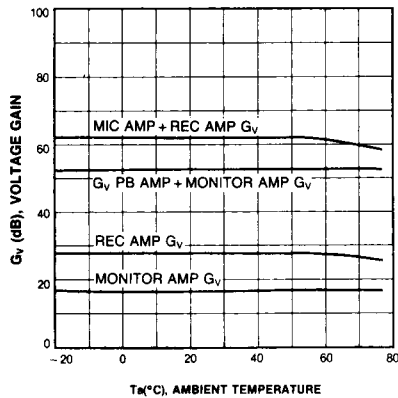

QUIESCENT CIRCUIT CURRENT-SUPPLY VOLTAGE

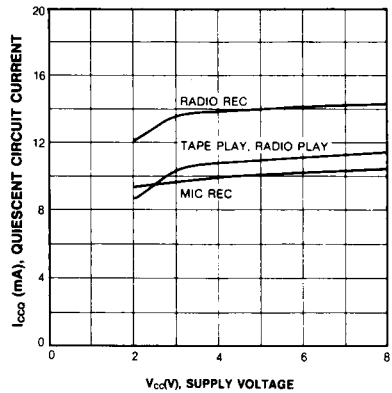

PIN VOLTAGE-SUPPLY VOLTAGE

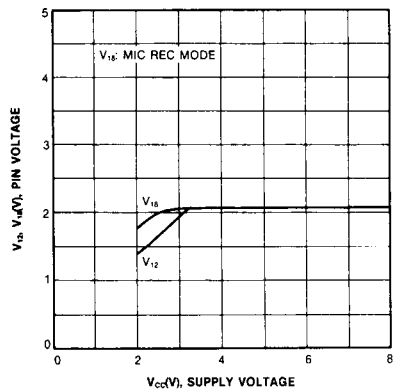

APPLICATION INFORMATION

CONTROL SWITCH TERMINAL (2 , 6-PIN) THRESHOLD VOLTAGE

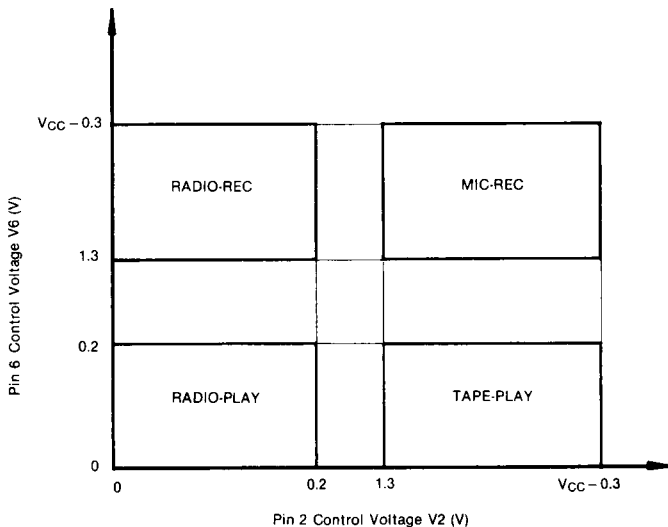

Fig. 3

3

APPLICATION CIRCUIT

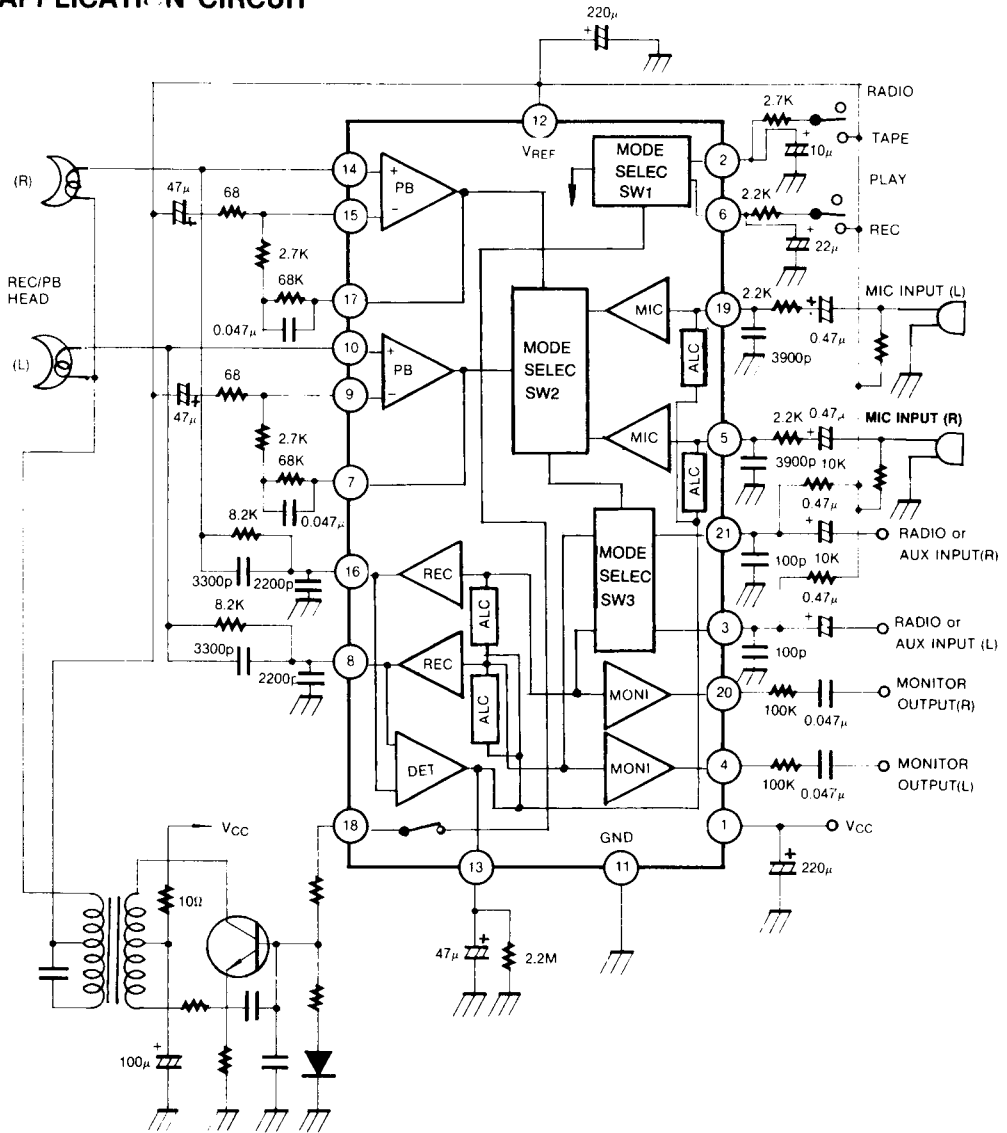

Fig. 4