

## TA7283AP

T-74-05-01

## LOW FREQUENCY POWER AMPLIFIER

TA7283AP is an audio power IC with built-in two channels developed for portable radio cassette type recorder.

Because of the parts reduction and SIP (Single In line Package), space merit is remarkable. Thermal shut down protection circuit is built in.

- High Power :  $P_{OUT(1)}=2.5W/CH$  (Typ.)  
( $V_{CC}=9V$ ,  $R_L=4\Omega$ ,  $f=1kHz$ ,  $THD=10\%$ )  
:  $P_{OUT(2)}=4.6W/CH$  (Typ.)  
( $V_{CC}=12V$ ,  $R_L=4\Omega$ ,  $f=1kHz$ ,  $THD=10\%$ )
- Low Popping Noise at Power ON
- Small Quiescent Current  
:  $I_{CCQ}=19mA$ (Typ.) ( $V_{CC}=9V$ ,  $V_{IN}=0$ )
- Soft Clip
- Built-in Thermal Shut Down Protection Circuit
- Best for Supply Voltage 9V, 12V
- Operation Supply Voltage Range :  $V_{CC}=6\sim 15V$

Unit in mm

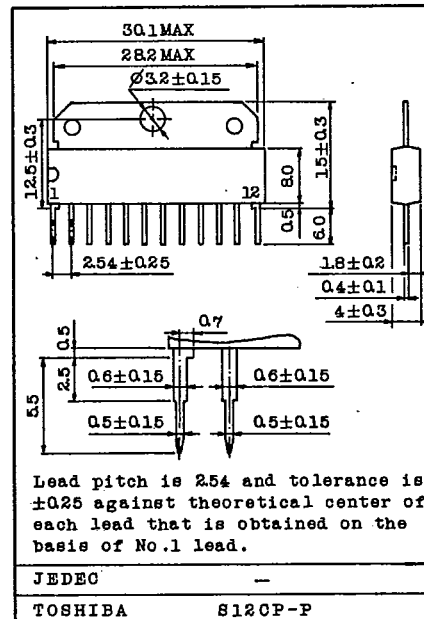

Lead pitch is 2.54 and tolerance is  $\pm 0.25$  against theoretical center of each lead that is obtained on the basis of No.1 lead.

Weight : 3.2g(Typ.)

MAXIMUM RATINGS ( $T_a=25^\circ C$ )

CHARACTERISTIC	SYMBOL	RATING	UNIT
Supply Voltage	$V_{CC}$	16	V
Output Current (Peak/CH)	$I_O(\text{peak})$	2.5	A
Power Dissipation	$P_D$	12.5	W
Operating Temperature	$T_{opr}$	-20~75	$^\circ C$
Storage Temperature	$T_{stg}$	-55~150	$^\circ C$

AUDIO LINEAR IC

9097247 TOSHIBA, ELECTRONIC

02E 17037 D

**TA7283AP**

T-74-05-01

## ELECTRICAL CHARACTERISTICS

(Unless otherwise specified,  $V_{CC}=9V$ ,  $R_L=4\Omega$ ,  $R_g=600\Omega$ ,  $f=1kHz$ ,  $T_a=25^\circ C$ )

CHARACTERISTIC	SYMBOL	TEST CIR-CUIT	TEST CONDITION	MIN.	TYP.	MAX.	UNIT
Quiescent Current	$I_{CCQ}$	-	$V_{in}=0$	-	19	45	mA
Output Power	$P_{OUT(1)}$	-	THD=10%	2.0	2.5	-	W
	$P_{OUT(2)}$	-	THD=10%, $V_{CC}=12V$	-	4.6	-	
Total Harmonic Distortion	THD	-	$P_{OUT}=1W/CH.$	-	0.2	1.0	%
Voltage Gain	$G_V(1)$	-	$R_f=82\Omega$ $V_{OUT}=0.775V_{rms}$	43	45	47	dB
	$G_V(2)$	-	$R_f=0$ , $V_{OUT}=0.775V_{rms}$	-	56	-	
Input Resistance	$R_{IN}$	-	-	-	30	-	$k\Omega$
Output Noise Voltage	$V_{NO}$	-	$R_g=10k\Omega$ $BW=20Hz\sim 20kHz$	-	0.3	1.0	$mV_{rms}$
Ripple Rejection Ratio	R.R.	-	$R_g=600\Omega$ $f_{ripple}=100Hz$	-	54	-	dB
Cross Talk	C.T.	-	$R_g=10k\Omega$ , Amp1 ↔ 2 $V_{OUT}=0dBm$ , $f=1kHz$	-	60	-	dB
Input Offset Voltage	$V_5, V_7$	-	-	-	20	60	mV

TYPICAL DC VOLTAGE OF EACH TERMINAL ( $V_{CC}=9V$ ,  $T_a=25^\circ C$ )

TERMINAL No.	1	2	3	4	5	6	7	8	9	10	11	12
DC Voltage (V)	8.2	4.5	8.9	0.6	0.01	GND	0.01	0.6	GND	4.5	8.2	$V_{CC}$

TOSHIBA

# TA7283AP

T-74-05-01

## BLOCK DIAGRAM/TEST CIRCUIT

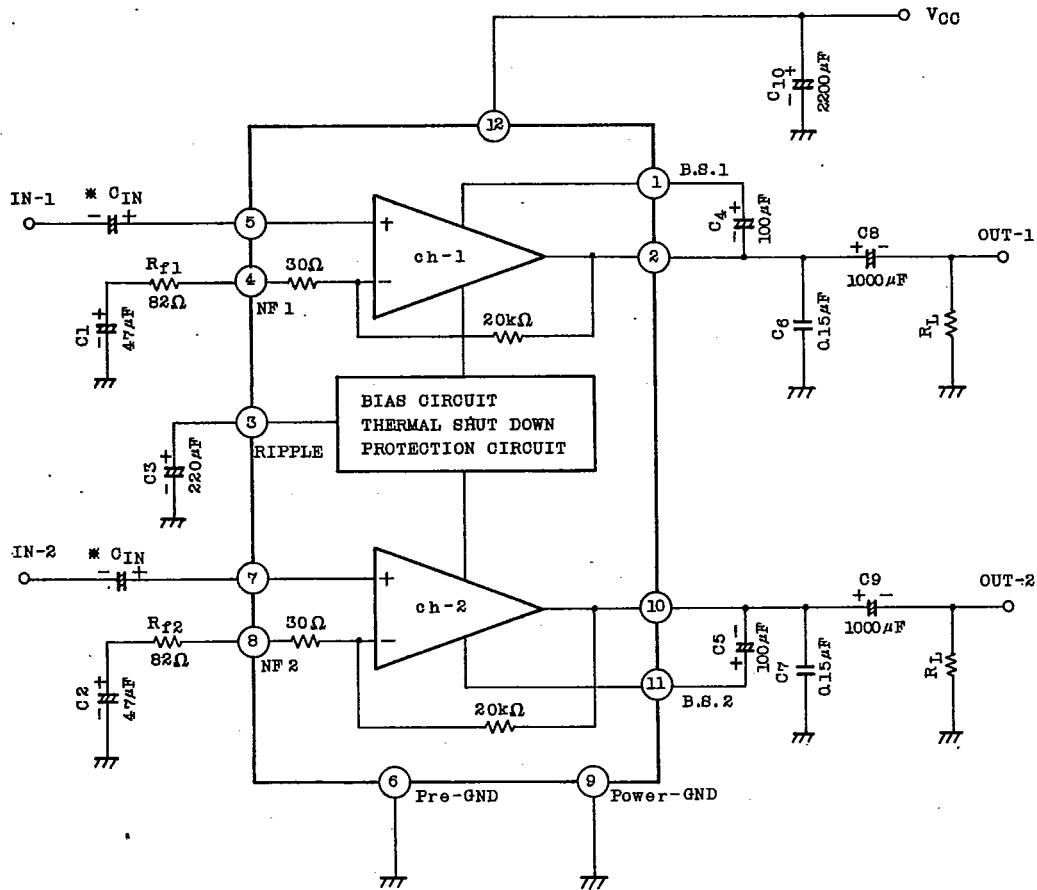

\* This IC can be used without coupling capacitor ( $C_{in}$ ). If volume slide noise occurred by input offset voltage is undesirable, it needs to use the capacitor ( $C_{in}$ ).

**AUDIO LINEAR IC**

**TA7283AP**

T-74-05-01

## APPLICATION INFORMATION AND APPLICATION METHOD

## 1. ADJUSTMENT OF VOLTAGE GAIN

The voltage gain  $G_v$  is obtained as follows by  $R_1$ ,  $R_2$  and  $R_f$  Fig.1.

$$G_v = 20 \log \frac{R_f + R_1 + R_2}{R_f + R_1}$$

When  $R_f = 0$   $G_v = 56\text{dB (Typ.)}$

When  $R_f = 82\Omega$ ,  $G_v = 45\text{dB (Typ.)}$

By increasing  $R_f$ , reduction of  $G_v$  is possible. However, since the feedback increase is liable to produce oscillation, it is recommended to use this at 40dB or over.

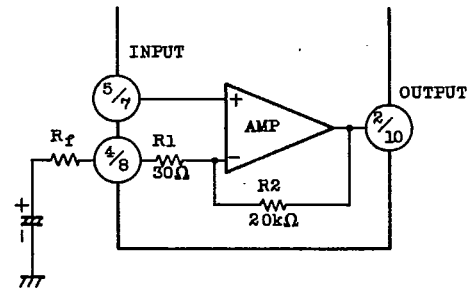

Fig. 1

## 2. THERMAL SHUT-DOWN CIRCUIT

The thermal shut-down circuit is built in for the purpose of preventing the destruction of IC due to the abnormal temperature rise when the heat radiation is insufficient.

The operation temperature is set at radiation  $F_{in}$  temperature  $175^\circ\text{C (Typ.)}$ .

At this temperature or over the bias is interrupted to prevent the destruction of IC.

## 3. INPUT STAGE

The input circuit of this IC is as shown in Fig.2. PNP Tr:Q1 is provided in the input circuit so as to make its usage possible without the input coupling capacitor.

However, at pins ⑤ and ⑦, max 60mV offset voltage is produced.

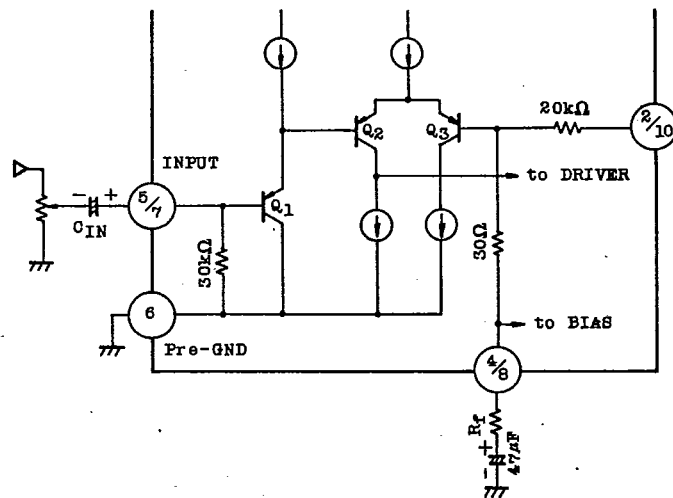

Fig. 2

9097247 TOSHIBA. ELECTRONIC

02E 17040 D

**TA7283AP**

T-74-05-01

Application after checking volume slide noise is recommended.

For cutting the volume slide noise, insert the input capacitor:  $C_{in}$  in series to interrupt the DC component.

#### 4. OSCILLATION PREVENTIVE MEASURES

For oscillation preventive capacitor  $C_6$  and  $C_7$  between the output terminal and GND, it is recommended to use polyester film capacitor having good characteristics for temperature and for high frequency.

Since the characteristics of the capacitor is liable to be influenced by the temperature, use this capacitor after the temperature test to check the oscillation allowance.

In addition, as the position of the electrolytic capacitor has a remarkable influence on the oscillation, connect  $C_{10}$  to  $V_{CC}$  at the nearest possible position from power GND.

At using this application with the voltage gain reduced, oscillation is liable to be produced. Apply the capacitor after cheking enough for its capacity, type and mounting position.

As the oscillation allowance varies according to the printed pattern layout, the standard printed board of TOSHIBA is recommended to be referred to for design it.

#### 5. INPUT VOLTAGE

When the excessive signal is input, turning-up is produced in the clip waveform. The turning-up point is  $V_{in}=300mV_{rms}(Typ.):V_{CC}=9V, R_L=4\Omega, f=1kHz$ : Enough care must be taken for this phenomenon.

**AUDIO LINEAR IC**

# TA7283AP

T-74-05-01

STANDARD PRINT PATTERN

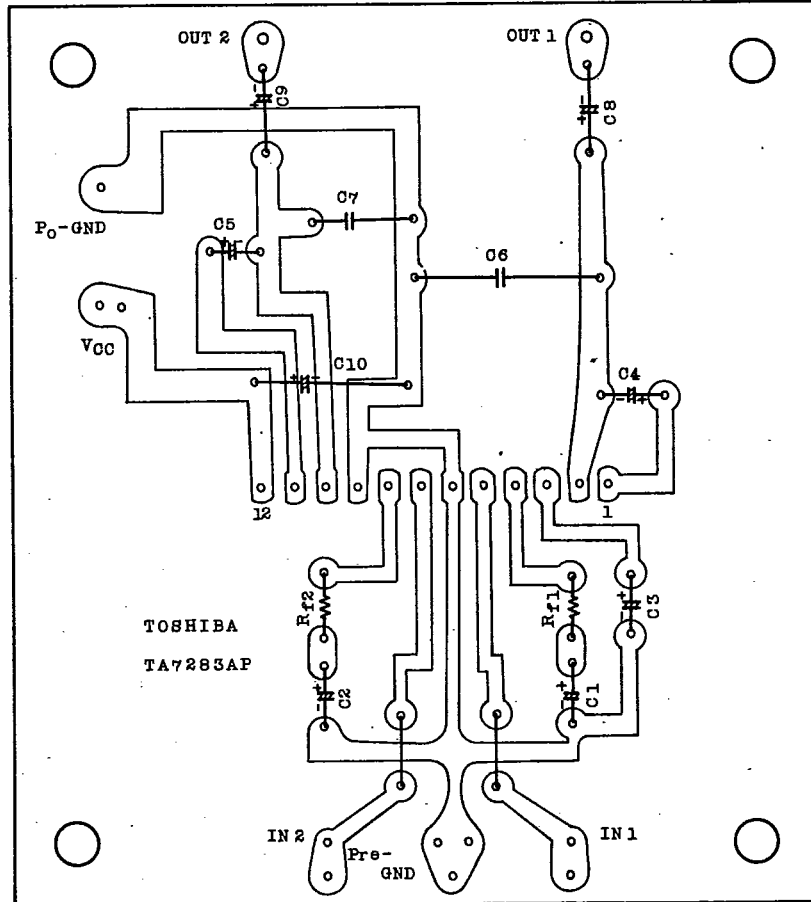

# TA7283AP

T-74-05-01

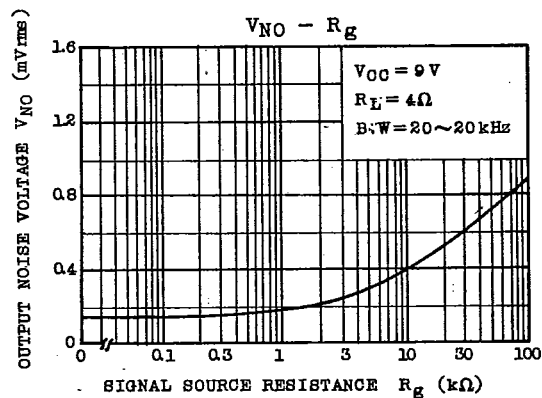
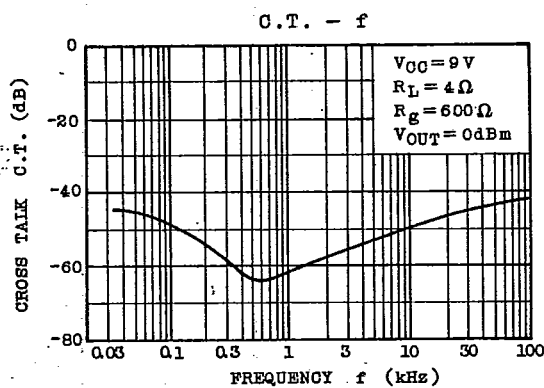
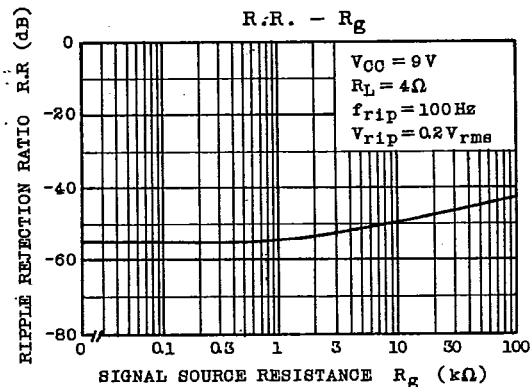
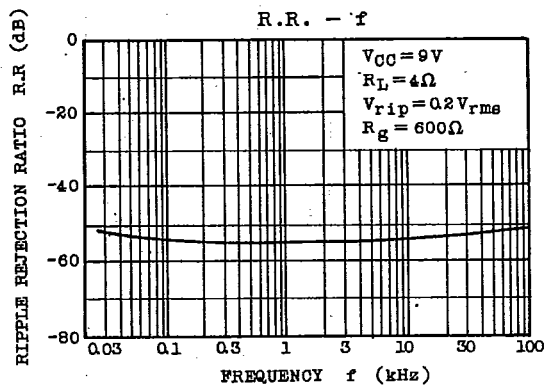
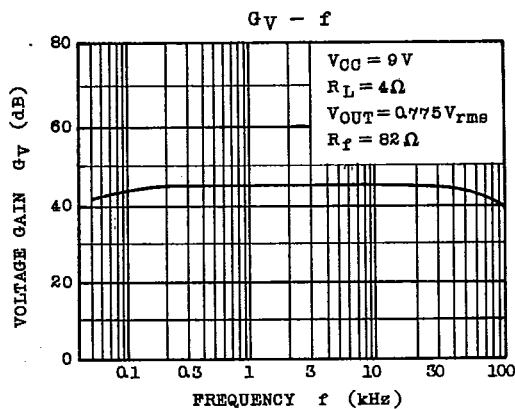
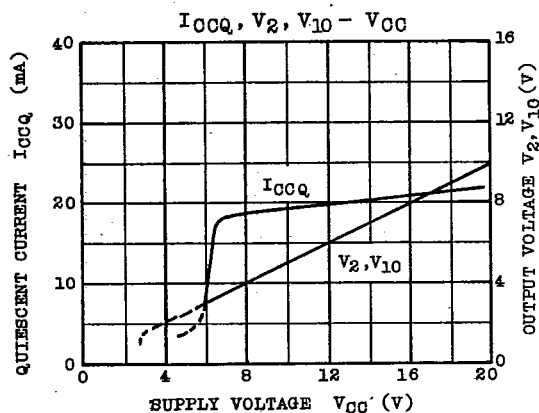

AUDIO LINEAR IC

# TA7283AP

T-74-05-01

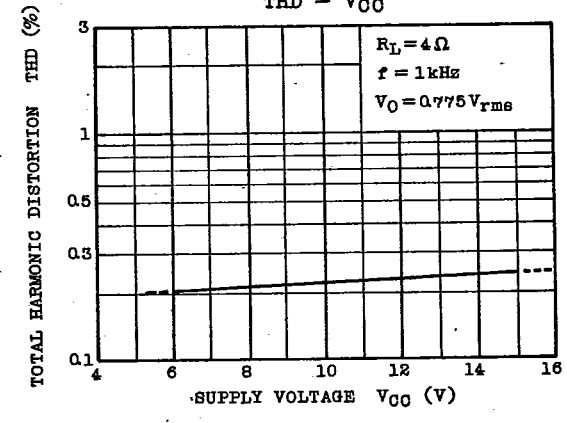
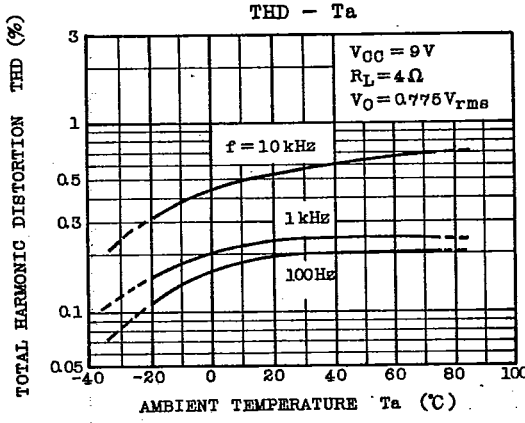
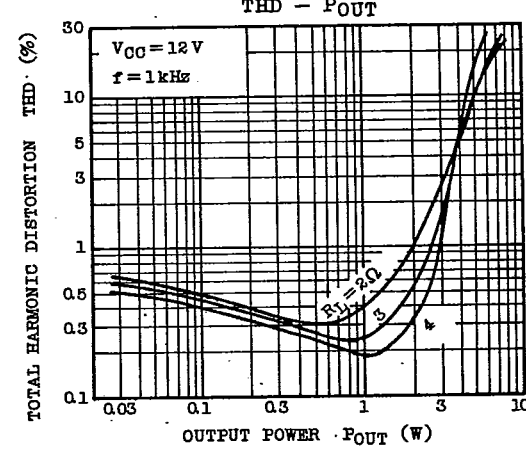
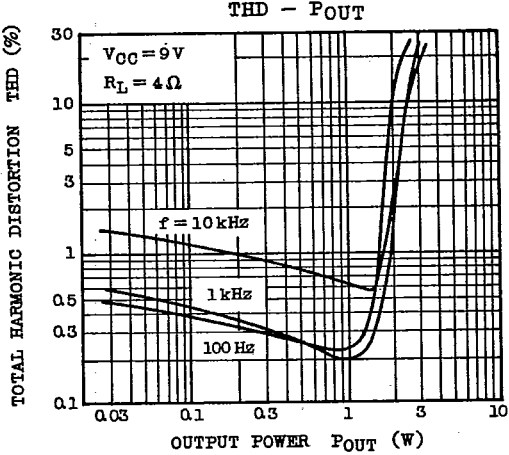
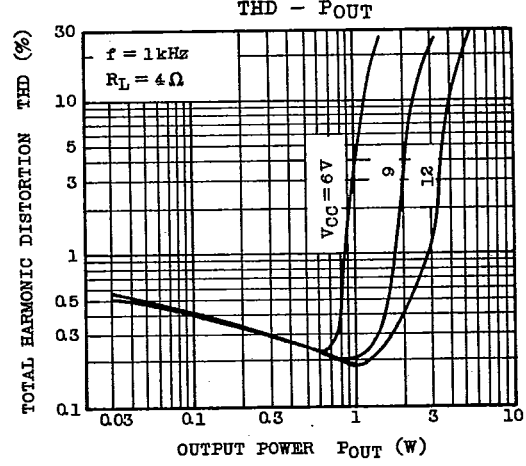
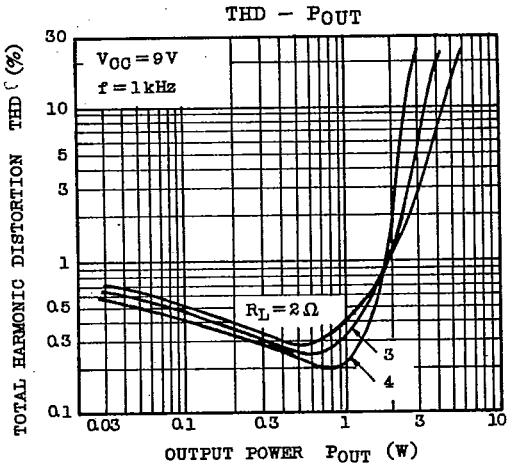



# TA7283AP

T-74-05-01

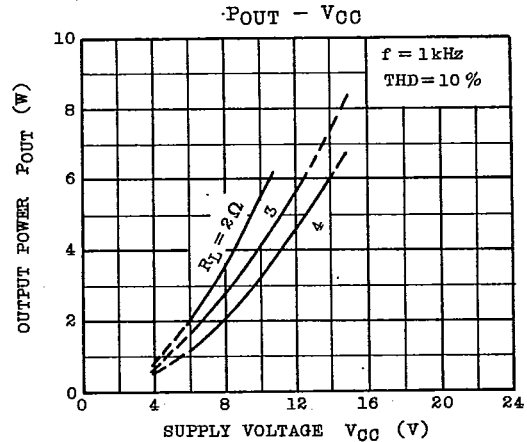
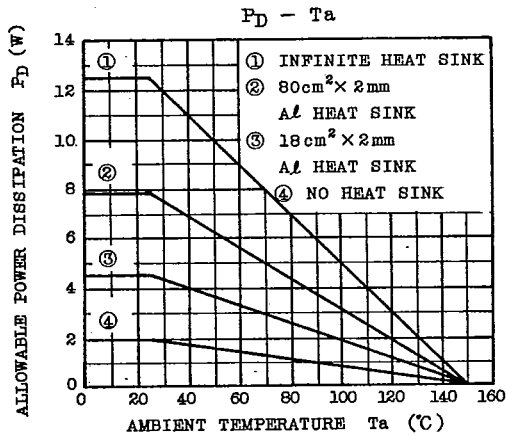
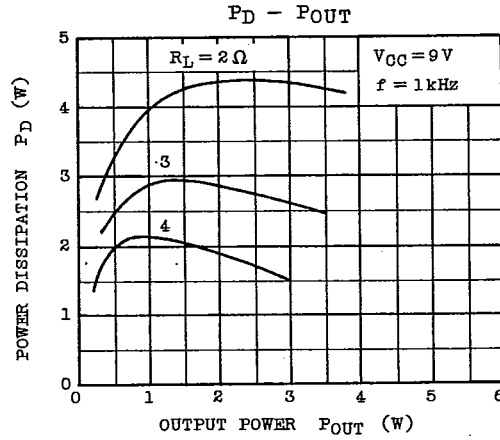
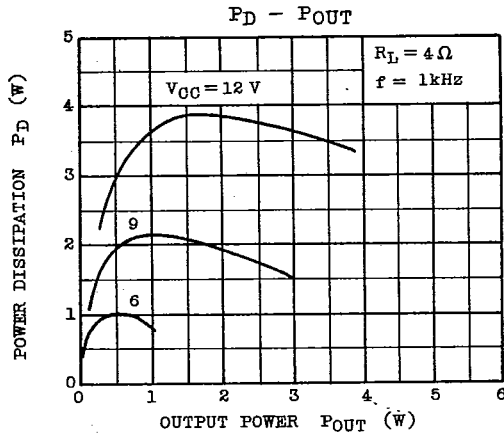
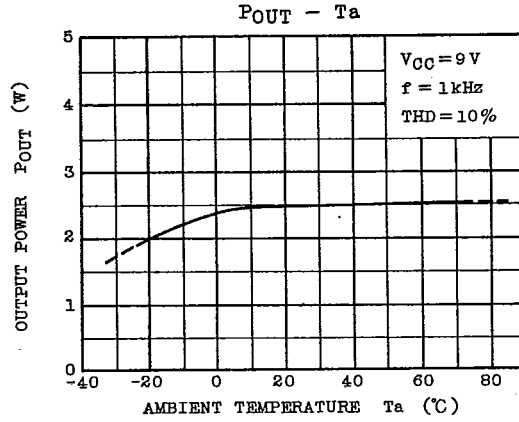
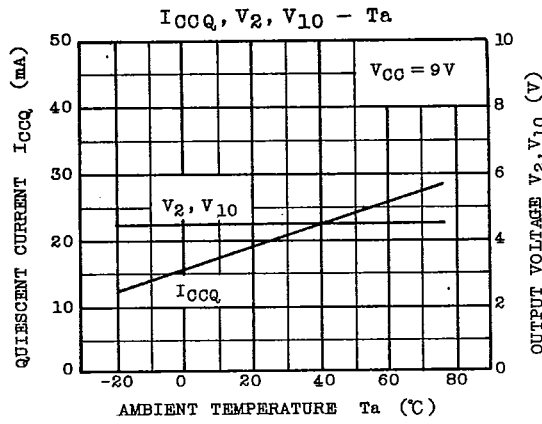

AUDIO LINEAR IC

# TA7283AP

T-74-05-01

