

**SANYO**

No. 4787

**LA1836, LA1836M****Single-Chip Home Stereo Electronic Tuning IC****Functions**

- AM: RF amplifier, mixer, oscillator (with ALC), IF amplifier, detector, AGC, oscillator buffer, tuning indicator (narrow-band SD), IF buffer output, IF output for AM stereo
- FM IF: IF amplifier, quadrature detector, band muting, tuning indicator, IF buffer output, S-meter
- MPX: PLL stereo decoder, stereo indicator, forced mono, VCO stop function, adjacent channel interference rejection function (114 kHz), post-amplifier (with muting function)

**Features**

- Reduced number of adjustments (adjustment-free MPX VCO: ceramic resonator adopted)
- Tuning indicator pin (Can be used as a narrow-band stop signal and as a muting output driver.)
- Variable FM stop sensitivity and band
- Variable AM stop sensitivity
- Built-in AM local oscillator buffer
- Variable AM low cut control

**Package Dimensions**

unit: mm

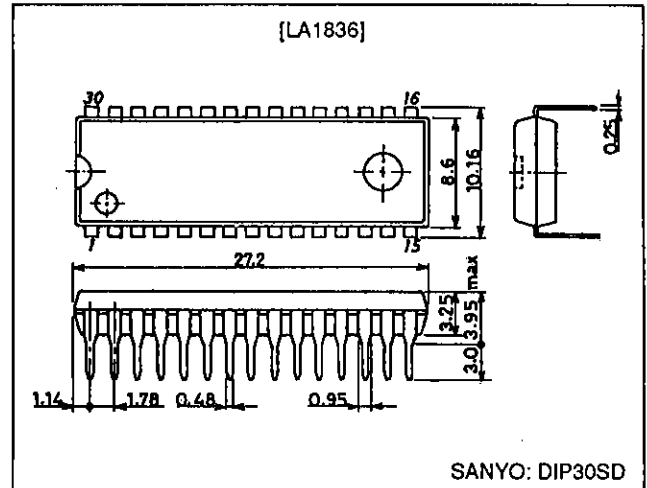
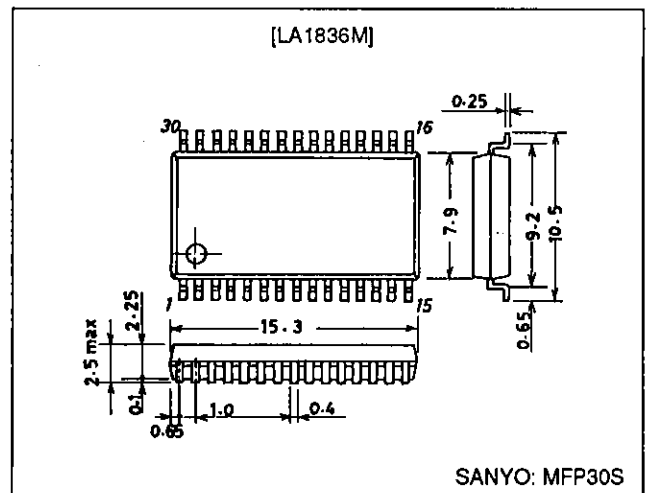
**3196-DIP30SD****3073A-MFP30S****Domestic (Japanese) products and import access products**

- Note: 1. Both domestic (Japanese) products and import access products have the same package dimensions.  
2. "MT" is displayed on the package body of mini flat package (MFP) import access products only.

Import access products can be counted as foreign producer semiconductors.

**SANYO Electric Co., Ltd. Semiconductor Business Headquarters**

TOKYO OFFICE Tokyo Bldg., 1-10, 1 Chome, Ueno, Taito-ku, TOKYO, 110 JAPAN

## Specifications

### Maximum Ratings at $T_a = 25^\circ\text{C}$

Parameter	Symbol	Conditions	Ratings	Unit
Maximum supply voltage	$V_{CC\text{ max}}$		9.0	V
Allowable power dissipation	$P_d\text{ max}$	At $T_a \leq 70^\circ\text{C}$ , on the recommended printed circuit board* [LA1836, LA1836M]	550	mW
		At $T_a = 70^\circ\text{C}$ , independent IC [LA1836M only]	320	mW
Operating temperature	$T_{op\text{ r}}$		-20 to +70	$^\circ\text{C}$
Storage temperature	$T_{stg}$		-40 to +125	$^\circ\text{C}$

Note: \* An  $85 \times 115 \times 1.6\text{ mm}^3$  glass-epoxy printed circuit board.

### Operating Conditions at $T_a = 25^\circ\text{C}$

Parameter	Symbol	Ratings	Unit
Recommended supply voltage	$V_{CC}$	7.0	V
Operating supply voltage range	$V_{CC\text{ op}}$	6.5 to 8.5	V

### Electrical Characteristics at $T_a = 25^\circ\text{C}$ , $V_{CC} = 7.0\text{ V}$ unless otherwise specified (MFP package using the Yamaichi Electric IC-51-0302-426MF socket)

Parameter	Symbol	Conditions	min	typ	max	Unit
[FM characteristics (mono): $f_c = 10.7\text{ MHz}$ , $f_m = 1\text{ kHz}$ , with the coil adjusted at $V_{REG} - V_{AFC} = 0\text{ V}$ ]						
Quiescent current	$I_{cc\text{-FM}}$	No input		37	50	mA
Demodulator output	$V_{O\text{-FM}}$	100 dB $\mu$ , 100% mod, the pin 16 output	730	1100	1460	mVrms
Channel balance (mono)	C.B-mono	100 dB $\mu$ , 100% mod, the pin 16 output/pin 17 output	-1.5	0	+1.5	dB
Total harmonic distortion	THD-FM (1)	100 dB $\mu$ , 100% mod, the pin 16 output		0.3	1.3	%
	THD-FM (2)	100 dB $\mu$ , 200% mod, the pin 16 output		1.5	8.0	%
S/N ratio	S/N-FM	100 dB $\mu$ , 100% mod, the pin 16 output	72	80		dB
AM suppression ratio	AMR	100 dB $\mu$ , AM 30% mod, the pin 16 output	40	60		dB
Input limiting voltage	-3dBLS	100 dB $\mu$ , referenced to 100% mod, a 3 dB down input		34	42	dB $\mu$
LED on sensitivity	SD-On-FM		46	56	66	dB $\mu$
LED on bandwidth	SD-BW	100 dB $\mu$	90	125	170	kHz
IF count buffer output	$V_{IF\text{Buf-FM}}$	100 dB $\mu$ , the pin 11 output	80	120	160	mVrms
S-meter output	$V_{SM\text{-FM}} (1)$	0 dB $\mu$ , the pin 12 output	0	0.5	1.0	V
	$V_{SM\text{-FM}} (2)$	60 dB $\mu$ , the pin 12 output	1.8	3.2	4.5	V
	$V_{SM\text{-FM}} (3)$	100 dB $\mu$ , the pin 12 output	3.5	4.2	5.0	V
Muting attenuation	Mute-Att.	100 dB $\mu$ , 100% mod, the pin 16 output	80	95		dB
[FM characteristics (stereo): $f_c = 10.7\text{ MHz}$ , $f_m = 1\text{ kHz}$ , $L + R = 90\%$ , pilot = 10%, $V_{IN} = 100\text{ dB}\mu$ ]						
Separation - L	Sep-L	L mod, the pin 17 output/pin 16 output	30	45		dB
Separation - R	Sep-R	R mod, the pin 16 output/pin 17 output	30	45		dB
Stereo on level	ST-on	The pilot modulation such that $V7 < 0.7\text{ V}$	1.8	3.6	6.0	%
Stereo off level	ST-off	The pilot modulation such that $V7 > 4.5\text{ V}$		2.5		%
Total harmonic distortion (main)	THD-main	The pin 16 output		0.3	1.3	%
Channel balance (main)	C.B-main	The pin 16 output/pin 17 output	-1.5	0	+1.5	dB
Capture range	C.R	Pilot = 10%		$\pm 1.5$		%
Adjacent channel interference rejection ration	B.Rej.	$f_s = 113\text{ kHz}$ , $V_s = 90\%$ , pilot = 10%, the pin 16 output		40		dB

Continued on next page.

LA1836, 1836M

Continued from preceding page.

Parameter	Symbol	Conditions	min	typ	max	Unit
[AM characteristics: $f_c = 1000$ kHz, $f_m = 1$ kHz]						
Quiescent current	$I_{COO-AM}$	No input		29	42	mA
Detector output	$V_{O-AM} (1)$	23 dB $\mu$ , 30% mod, the pin 16 output	25	45	90	mVrms
	$V_{O-AM} (2)$	80 dB $\mu$ , 30% mod, the pin 16 output	195	310	490	mVrms
S/N ratio	S/N-AM (1)	23 dB $\mu$ , 30% mod, the pin 16 output	16	20		dB
	S/N-AM (2)	80 dB $\mu$ , 30% mod, the pin 16 output	48	54		dB
Total harmonic distortion	THD-AM (1)	80 dB $\mu$ , 30% mod, the pin 16 output		0.3	1.0	%
	THD-AM (2)	100 dB $\mu$ , 30% mod, the pin 16 output (DIP)		0.4	1.2	%
	THD-AM (2)	107 dB $\mu$ , 30% mod, the pin 16 output (MFP)		0.8	1.6	%
	THD-AM (3)	80 dB $\mu$ , 80% mod, the pin 16 output		1.0	4.0	%
LED on sensitivity	SD-On-AM		20	30	40	dB $\mu$
Local oscillator buffer output	$V_{OSC-AM}$	80 dB $\mu$ , 30% mod, the pin 16 output	110	160		mVrms
Low band attenuation	Low-Cut	Referenced to $f_m = 1$ kHz, the output when $f_m = 100$ Hz	5	7	11	dB
IF count buffer output	$V_{IFBuf-AM}$	80 dB $\mu$ , unmodulated, the pin 11 output	140	200	280	mVrms
ST-IF output	$V_{STIF-AM}$	80 dB $\mu$ , unmodulated, the pin 8 output	8	17	24	mVrms
S-meter output	$V_{SM-AM} (1)$	0 dB $\mu$ , unmodulated	0	0	0.2	V
	$V_{SM-AM} (2)$	40 dB $\mu$ , unmodulated	1.3	3.0	4.5	V

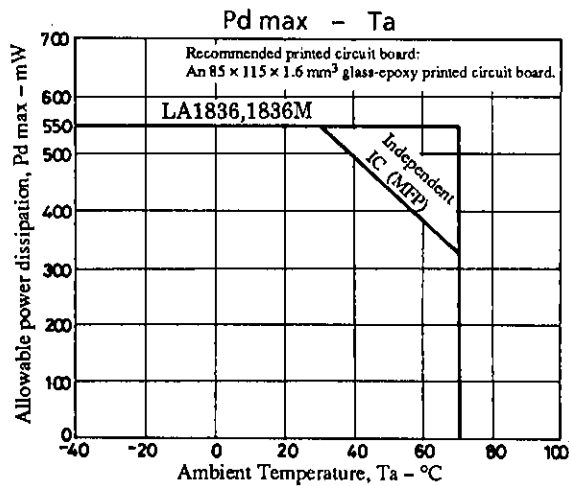

LA1836, 1836M

Block Diagram

Unit (resistance:  $\Omega$ , capacitance: F)

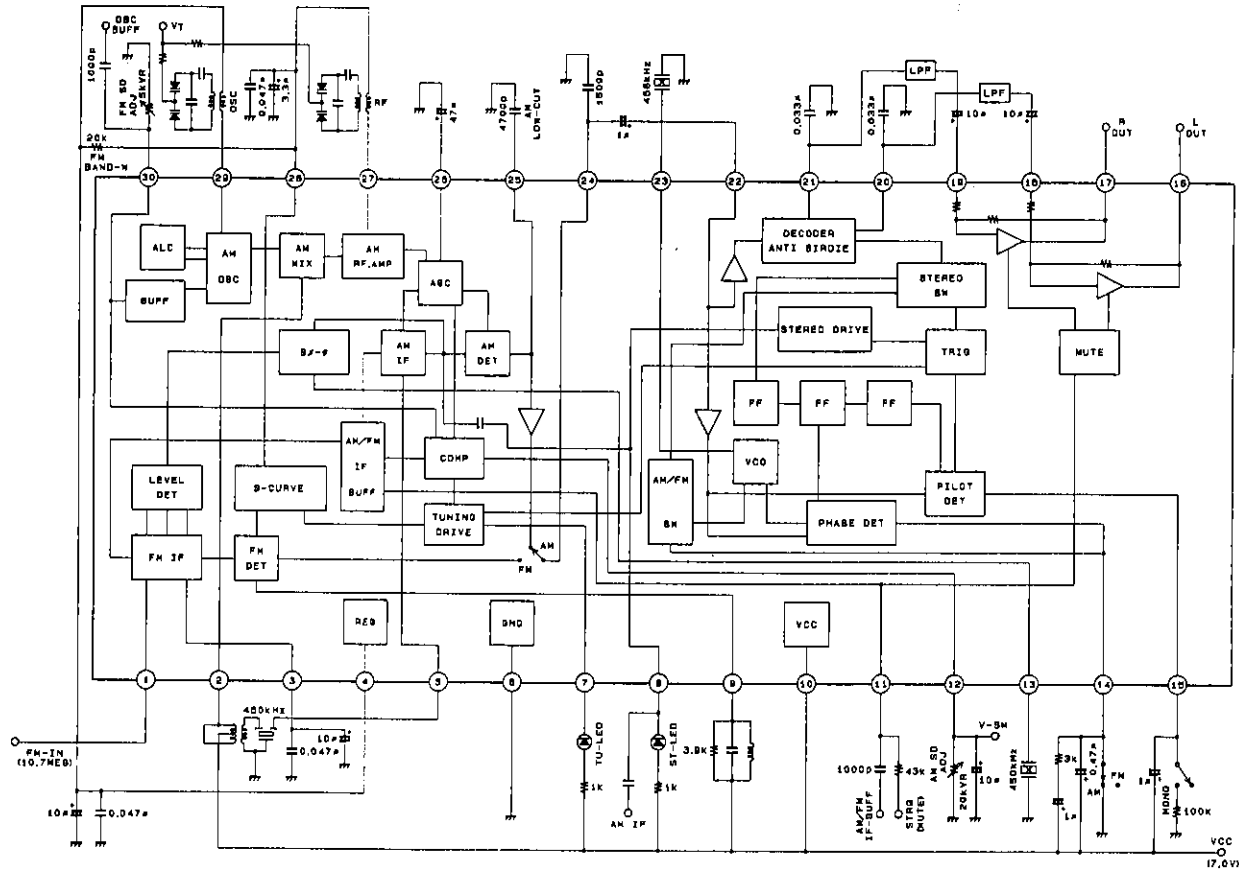

408039

Test Circuit Diagram

Unit (resistance:  $\Omega$ , capacitance: F)

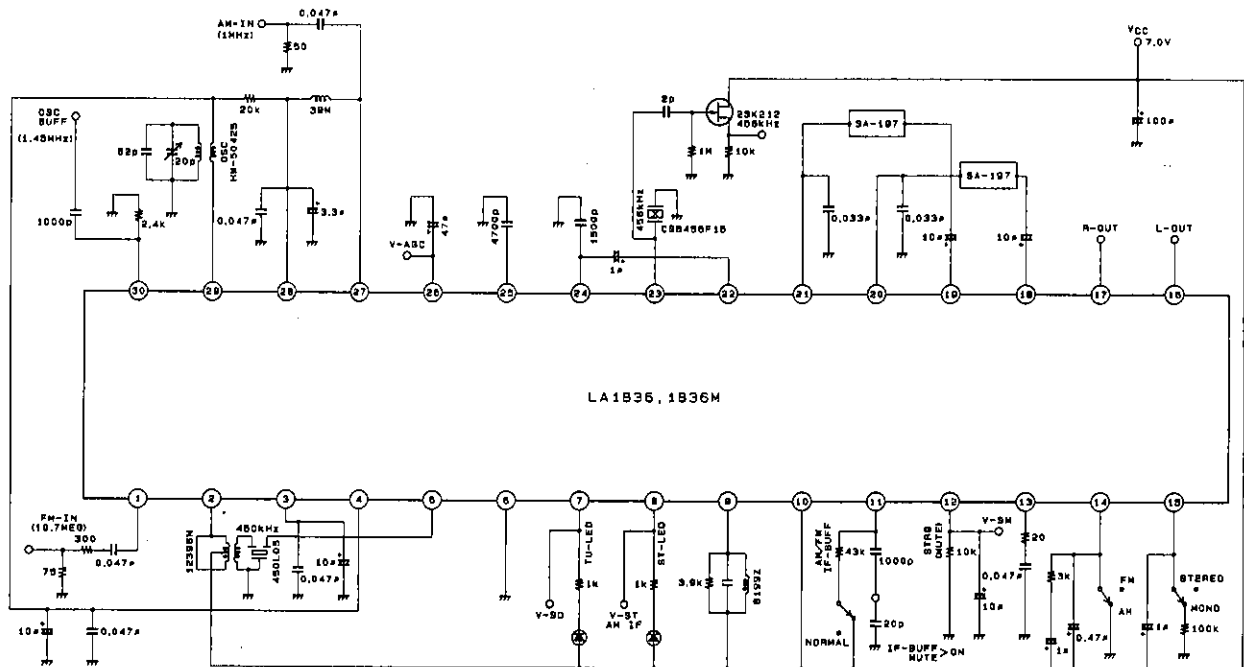

LA1836, 1836M

408037

Pin Functions

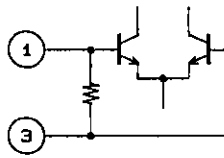
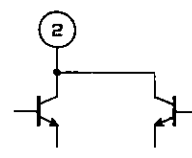
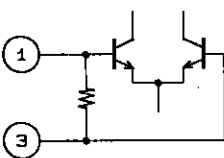
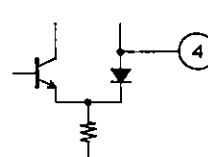
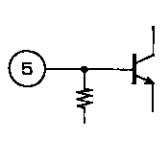
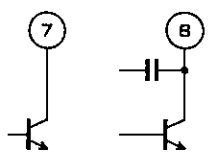
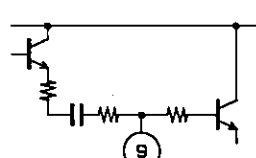
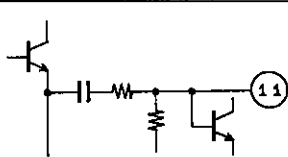
Pin No.	Function	Voltage	Internal equivalent circuit	Remarks
1	FM IF input	Vreg	 <p>A01486</p>	Input impedance $r_i = 330 \Omega$
2	AM mixer output	Vcc	 <p>A01487</p>	
3	FM IF input bypass	Vreg	 <p>A01488</p>	Also used for the AM noise filter
4	REG	Vreg	 <p>A01488</p>	Vreg = 3.6 V
5	AM IF input	Vreg	 <p>A01489</p>	Input impedance $r_i = 2 k\Omega$
6	GND	0 V		
7	Tu - LED	Vcc	 <p>A01490</p>	Active low Open collector AM stereo IF output (pin 8)
8	ST - LED, AM - IF output	Vcc		
9	FM detector	Vcc	 <p>A02038</p>	Recommended detector coil: 600TEAS-8199Z (Toko) SA281 (Sumida)
10	Vcc	Vcc		
11	AM/FM IF buffer output, output control SW (muting switch)	0 V	 <p>A01492</p>	The post-amplifier muting turns on for applied voltages of 1.3 V and over. The IF buffer output turns on at 4.0 V and over. Recommended muting on control voltage: 1.9 V

Continued on next page.

LA1836, 1836M

Continued from preceding page.

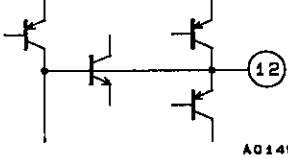
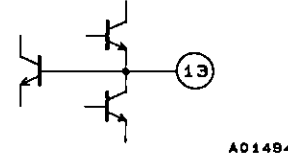
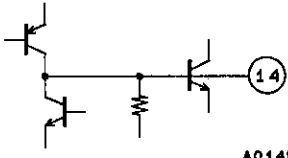
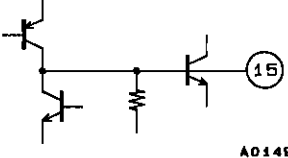
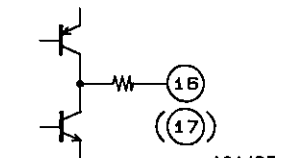
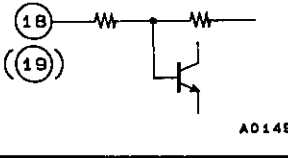
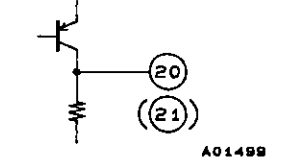
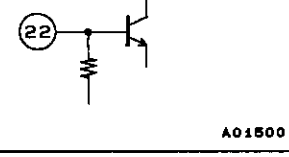
Pin No.	Function	Voltage	Internal equivalent circuit	Remarks
12	S-meter output, AM SD sensitivity adjustment	0.5 V (FM) 0 V (AM)	 A01493	The AM SD sensitivity can be adjusted with the resistor between this pin and ground. The AM SD sensitivity should be adjusted first, since the FM SD sensitivity is affected by this adjustment.
13	AM narrow band CF connection	1.5 V	 A01494	Recommended narrow band CF: BFU450C4N (Murata)
14	Phase comparator low-pass filter (FM/AM switch)	$V_{CC} - 1.4$ (FM) 0 V (AM)	 A01495	AM mode selected when this pin is connected to ground.
15	Pilot detector low-pass filter (forced mono) (VCO stop)	$V_{CC} - 1.0$	 A01496	The circuit is forced to mono when a current of 50 $\mu$ A or larger flows from this pin. Connecting this pin to ground stops the VCO.
16 17	Post-amplifier L output and R output	Vreg Vreg	 A01497	Output impedance $r_o = 200 \Omega$ Pin 16: left output Pin 17: right output
18 19	Post-amplifier L input and R input	Vreg Vreg	 A01498	Inverting inputs: $r_i = 3.3 \text{ k}\Omega$ Pin 18: left input Pin 19: right input
20 21	MPX output, L output and R output	3.5 V 3.5 V	 A01499	Output impedance $r_o = 3.3 \text{ k}\Omega$ Pin 20: left de-emphasis Pin 21: right de-emphasis
22	MPX input	2.9 V	 A01500	Input impedance $r_i = 20 \text{ k}\Omega$ The low-band separation characteristics are improved by increasing the value of the capacitor connected between this pin and pin 24. However, the impulse noise associated with AM/FM switching will increase.

Continued on next page.

LA1836, 1836M

Continued from preceding page.

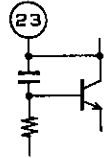
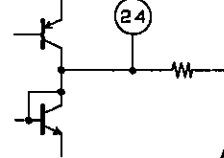
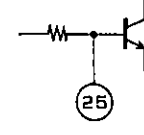
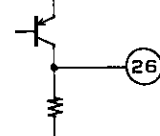
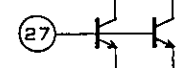
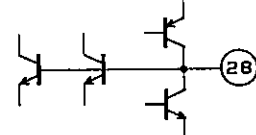
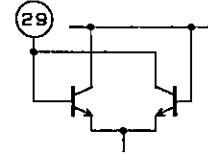
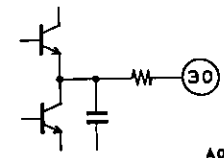
Pin No.	Function	Voltage	Internal equivalent circuit	Remarks
23	MPX VCO	3.5 V (FM) 0 V (AM)	 <p>A01501</p>	Recommended ceramic resonator: CSB456F15 (Murata)
24	AM/FM demodulator output	2.9 V (FM) 3.0 V (AM)	 <p>A01502</p>	Output impedance: 250 Ω (FM), 10 kΩ (AM) The separation can be adjusted with the external capacitor connected between this pin and ground.
25	AM low cut	2.9 V (FM) 3.0 V (AM)	 <p>A01503</p>	The AF demodulation frequency low area frequency characteristics can be adjusted with the external capacitor connected between this pin and ground. The AM detector output can be attenuated by connecting a resistor in series with this capacitor.
26	AM AGC	0 V (FM) 0.5 V (AM)	 <p>A01504</p>	Internal load resistance: R = 6.7 kΩ
27	AM RF input	Vreg	 <p>A02040</p>	This pin must be used at the same potential as pin 4.
28	AFC	Vreg	 <p>A02041</p>	The FM-SD bandwidth can be adjusted with the external resistor connected between this pin and pin 4.
29	OSC	Vreg	 <p>A01507</p>	The oscillator coil is connected between this pin and pin 4.
30	Oscillator buffer output, FM SD sensitivity adjustment	1.6 V (FM) 1.3 V (AM)	 <p>A01508</p>	The FM SD sensitivity can be adjusted with the external resistor connected between this pin and ground. Output impedance $r_o = 200 \Omega$

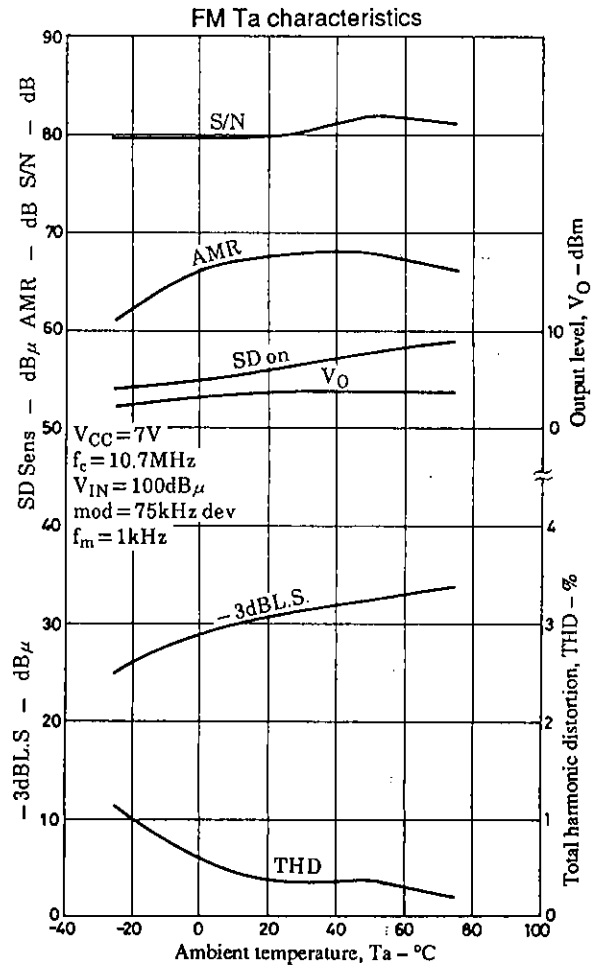
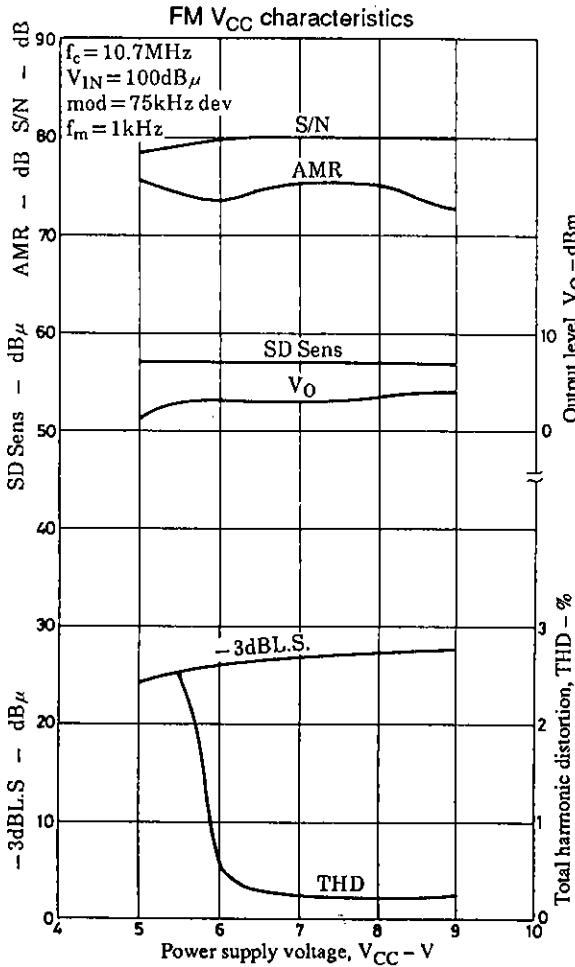
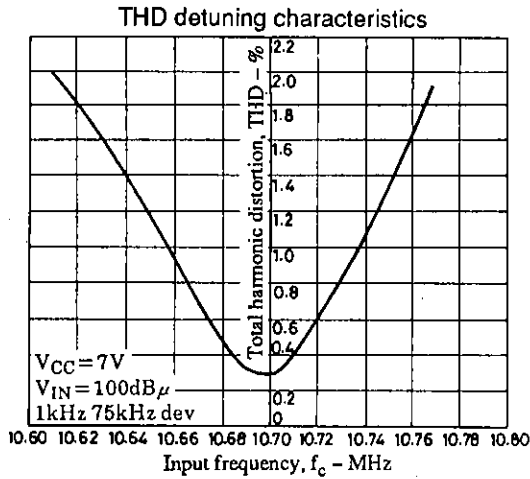
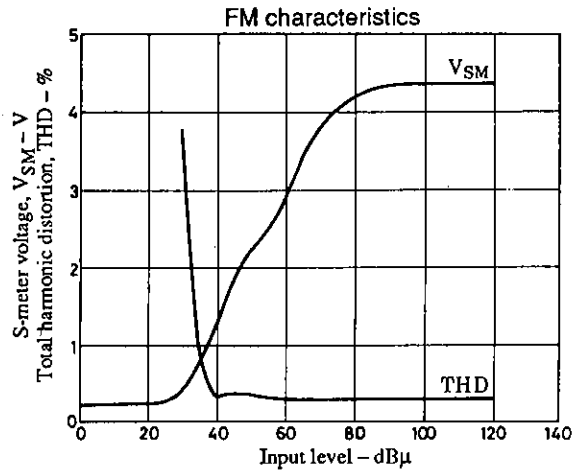
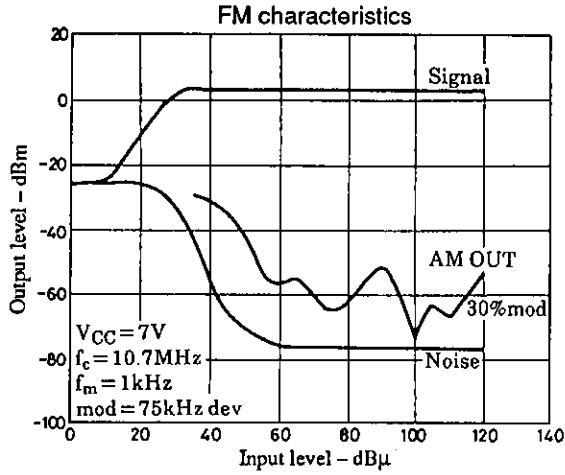



SD band  $V_{CC}$  characteristics

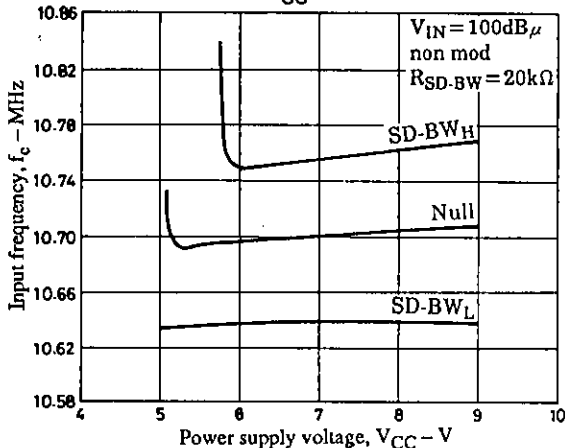

SD band  $T_a$  characteristics

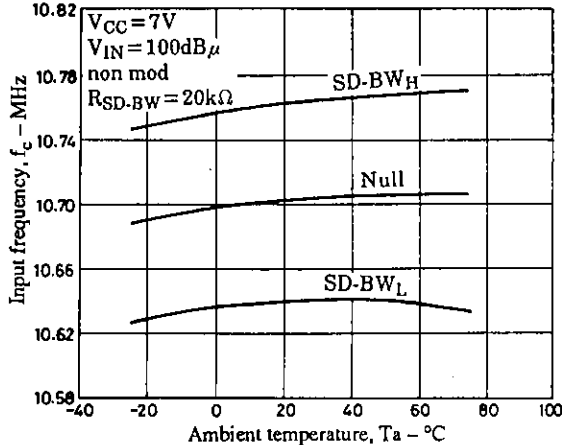

AM characteristics

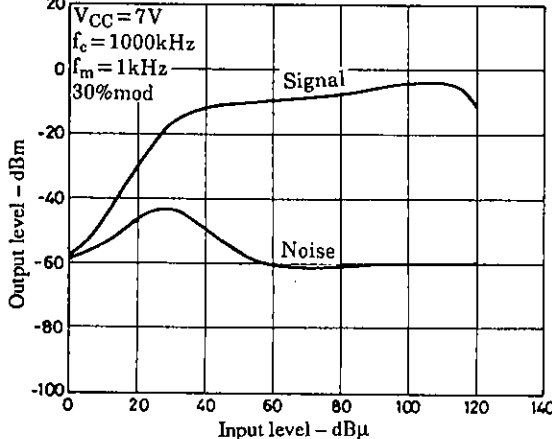

AM characteristics

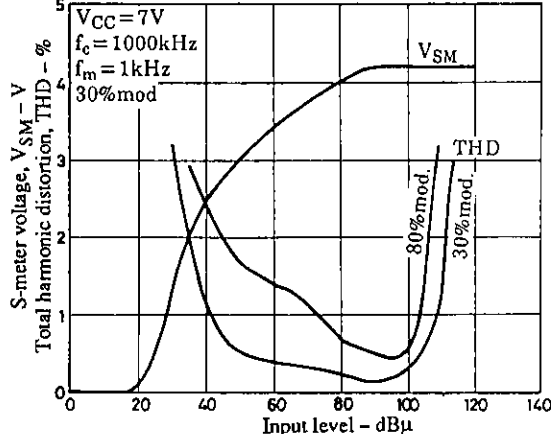

AM frequency characteristics

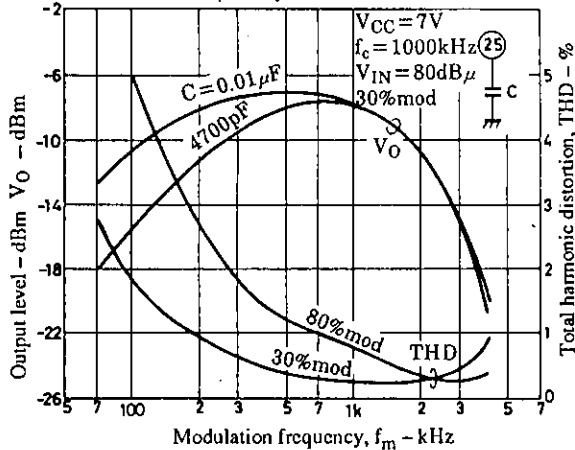

AM  $V_{CC}$  characteristics

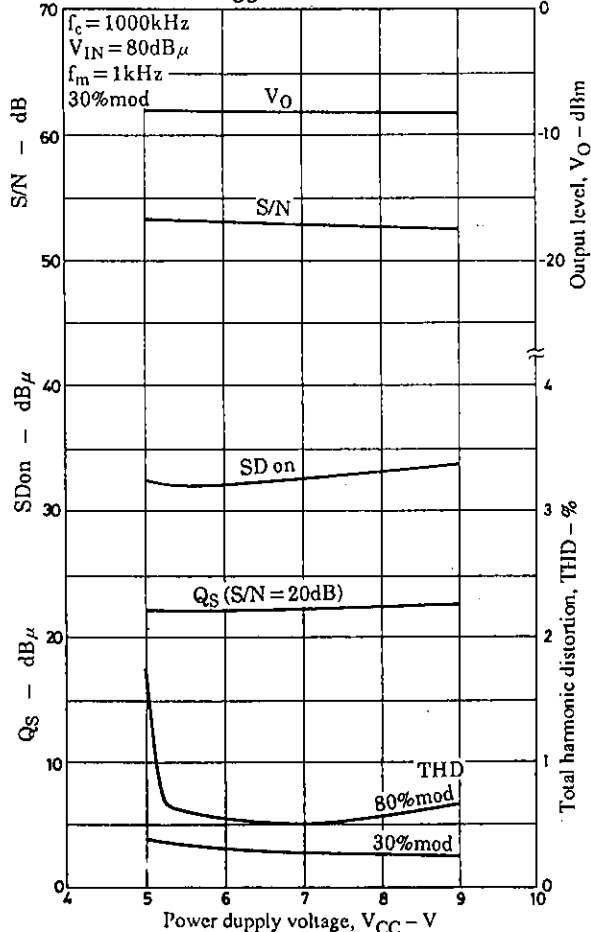

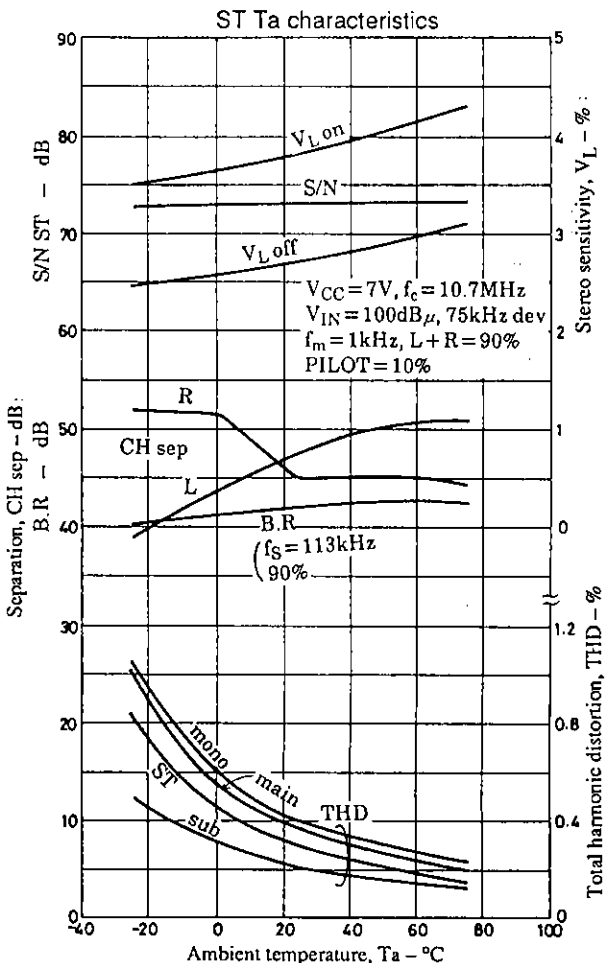
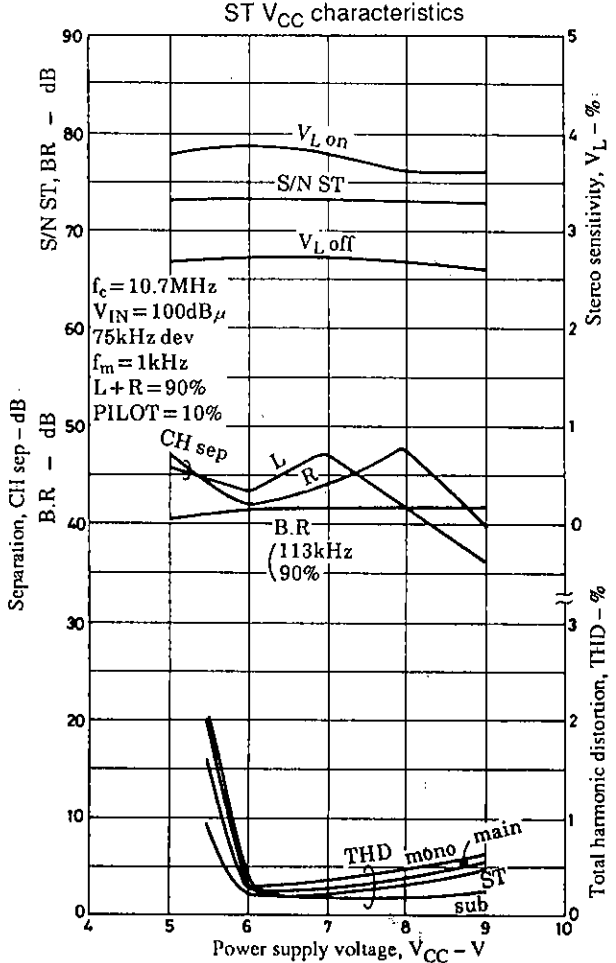
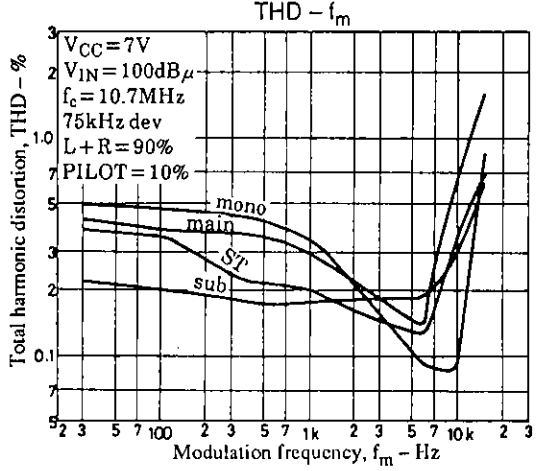
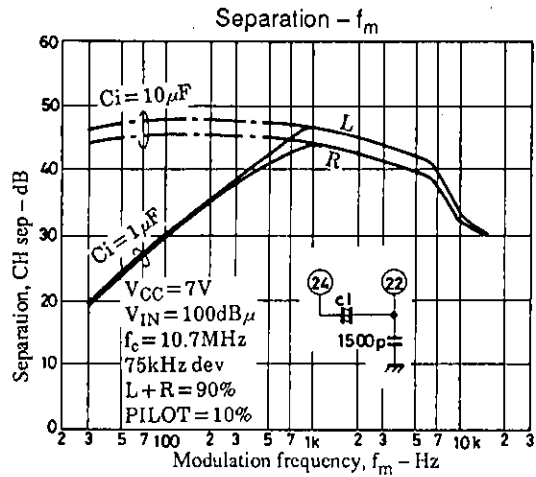
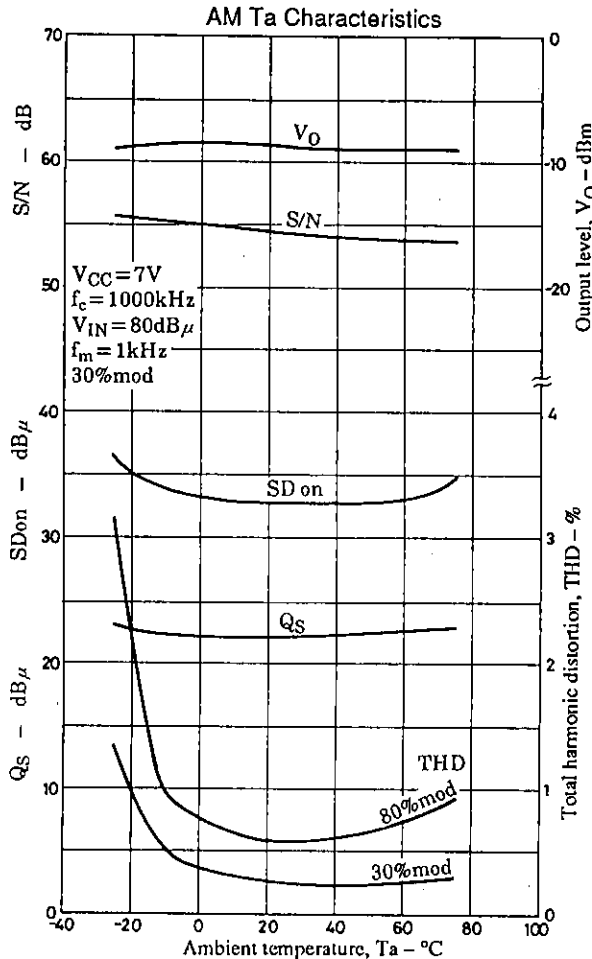

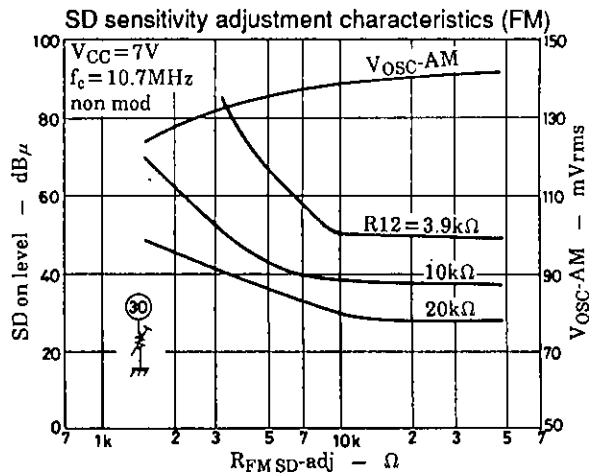
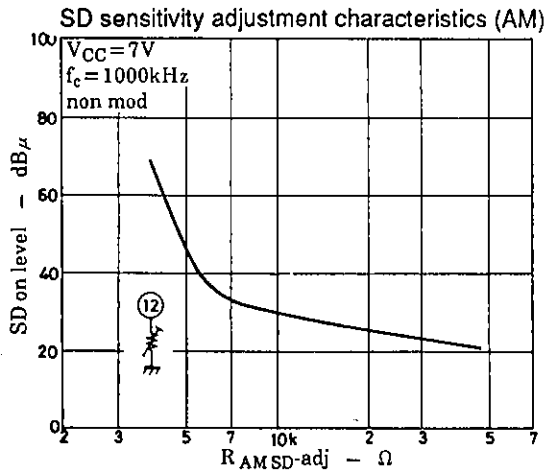
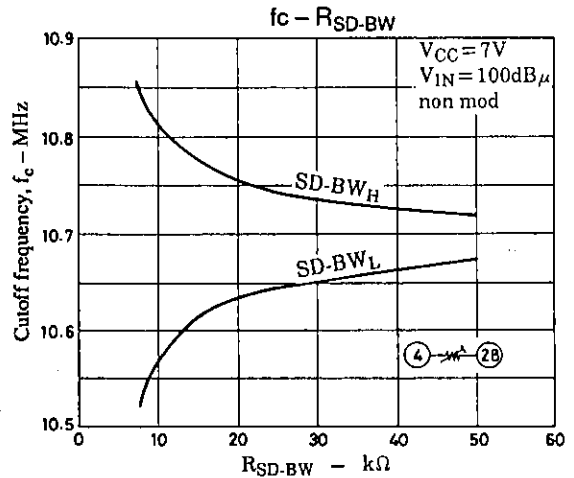
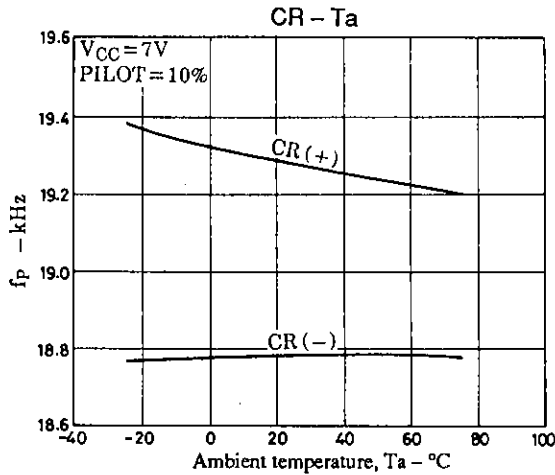
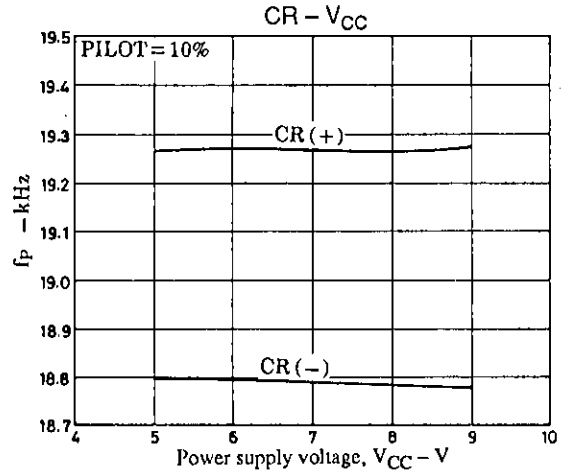
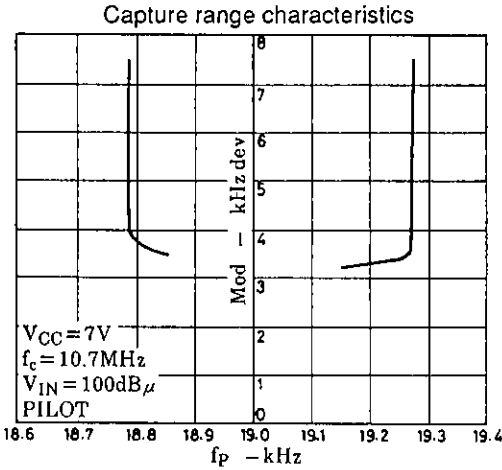
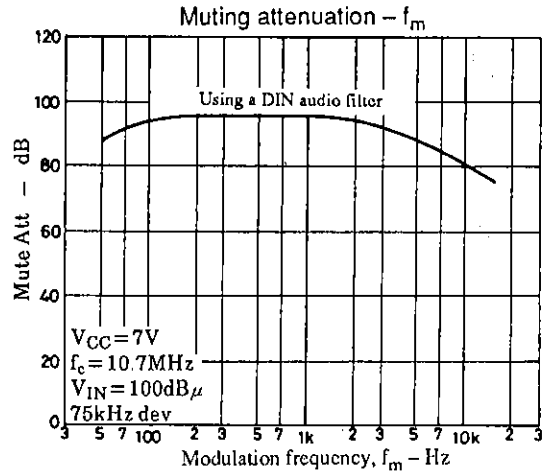
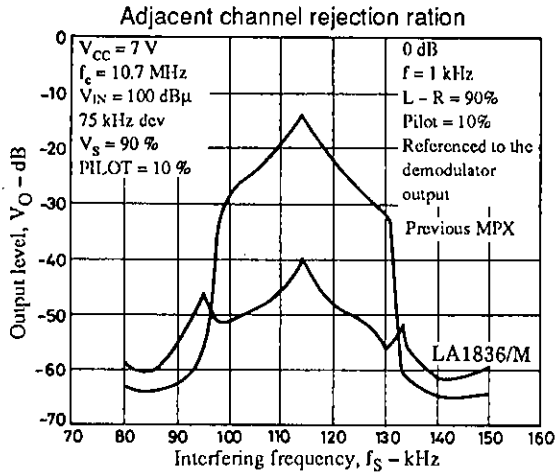

IF buffer output characteristics

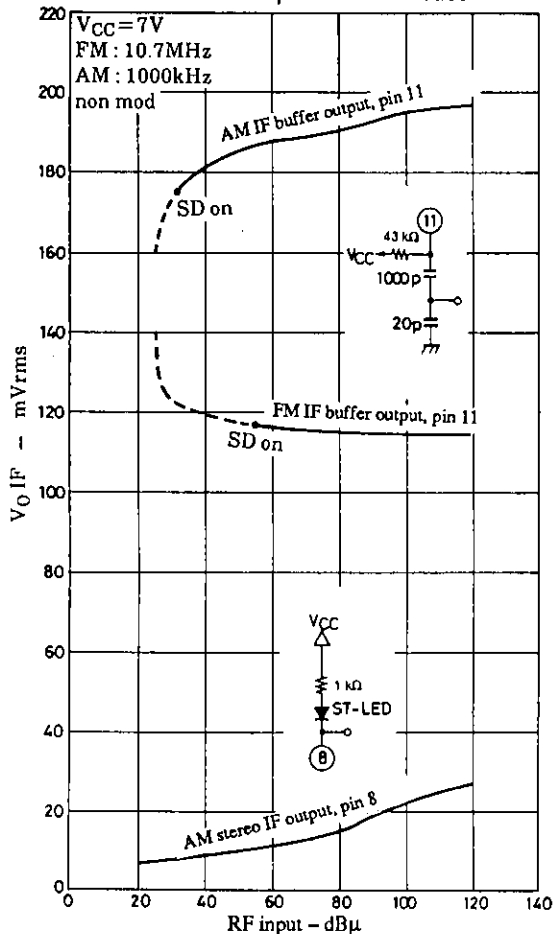

IF buffer output characteristics

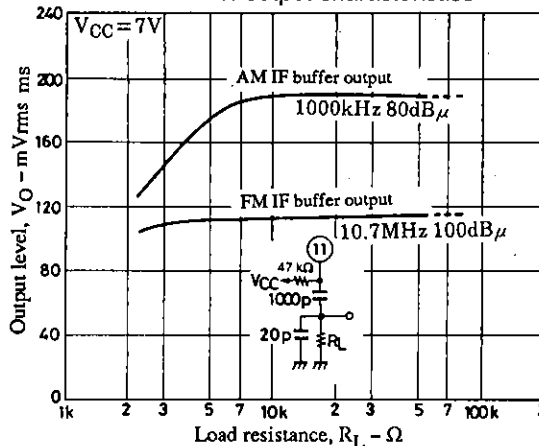

ST IF output characteristics

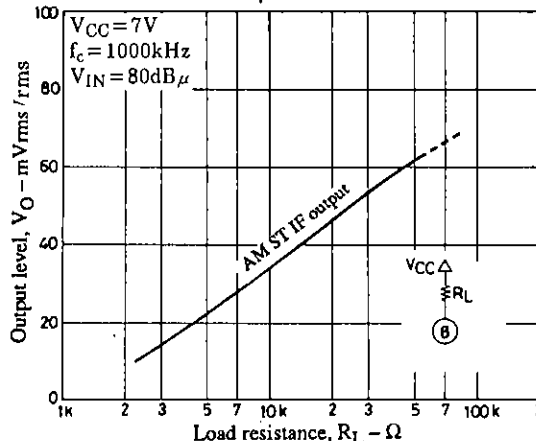

Oscillator and IF buffer outputs -  $V_{CC}$

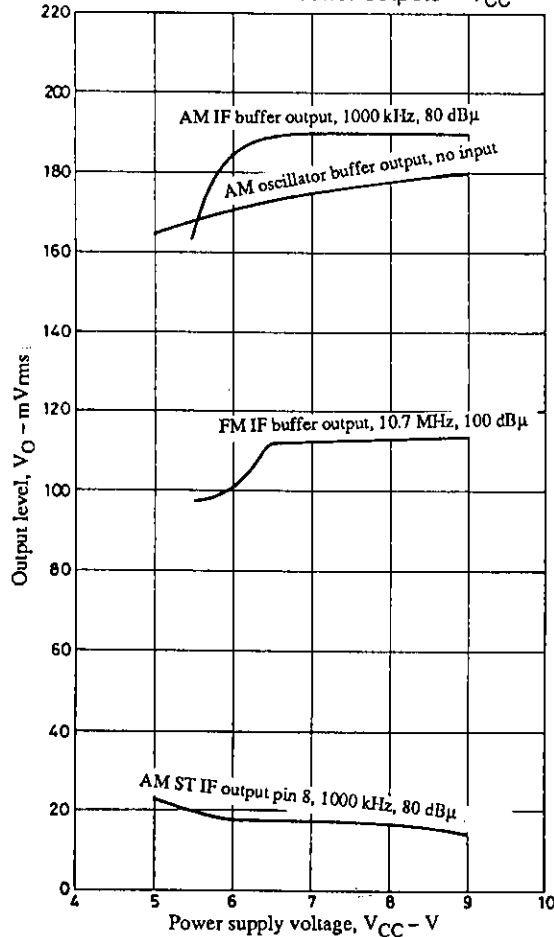

Oscillator and IF buffer outputs -  $T_a$  characteristics

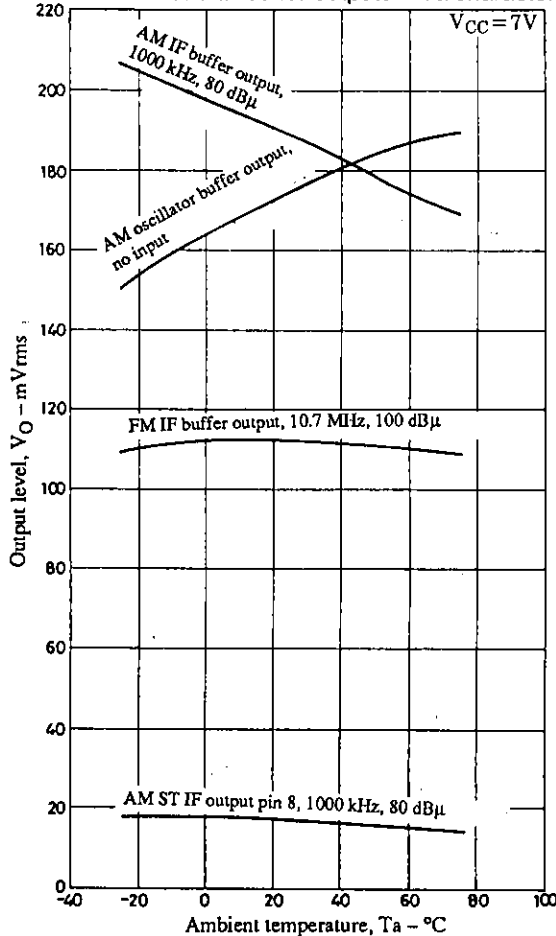

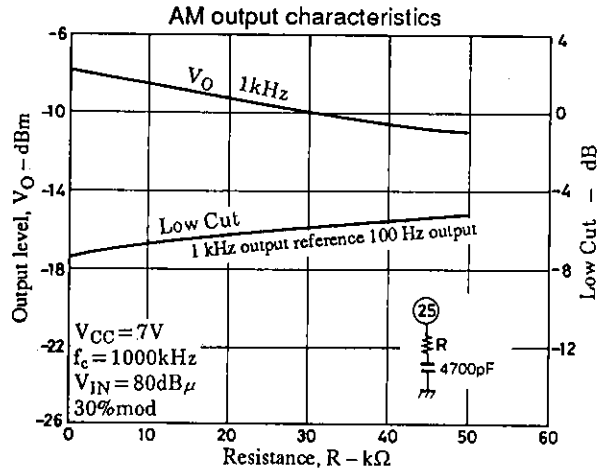
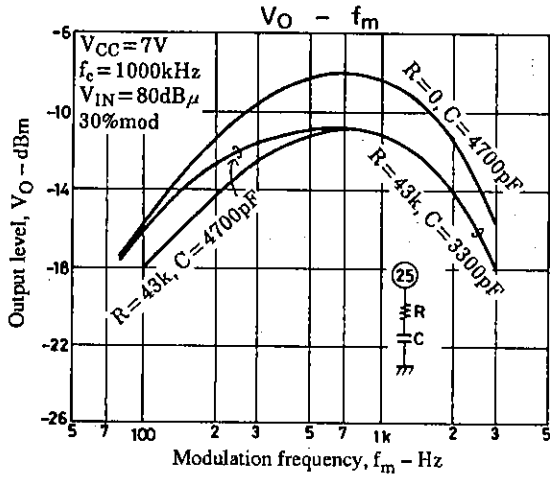

■ No products described or contained herein are intended for use in surgical implants, life-support systems, aerospace equipment, nuclear power control systems, vehicles, disaster/crime-prevention equipment and the like, the failure of which may directly or indirectly cause injury, death or property loss.

■ Anyone purchasing any products described or contained herein for an above-mentioned use shall:

- ① Accept full responsibility and indemnify and defend SANYO ELECTRIC CO., LTD., its affiliates, subsidiaries and distributors and all their officers and employees, jointly and severally, against any and all claims and litigation and all damages, cost and expenses associated with such use:
- ② Not impose any responsibility for any fault or negligence which may be cited in any such claim or litigation on SANYO ELECTRIC CO., LTD., its affiliates, subsidiaries and distributors or any of their officers and employees jointly or severally.

■ Information (including circuit diagrams and circuit parameters) herein is for example only; it is not guaranteed for volume production. SANYO believes information herein is accurate and reliable, but no guarantees are made or implied regarding its use or any infringements of intellectual property rights or other rights of third parties.