

LM1576-ADJ/LM2576-ADJ Simple Switcher™ 3 Amp Step-Down Voltage Regulator

General Description

The LM1576-ADJ series are monolithic integrated circuits that provide all the active functions for a step-down (buck) switching regulator. These devices feature an output voltage which is adjustable from 1.23V to 37V and is capable of driving a 3A load with excellent line and load regulation.

Requiring a minimum number of external components, these regulators are simple to use and include internal frequency compensation and a fixed-frequency oscillator.

The LM1576-ADJ series offers a high efficiency replacement for popular three-terminal adjustable linear regulators. It substantially reduces the size of the heat sink, and in many cases no heat sink is required.

A standard series of inductors are available from several different manufacturers optimized for use with the LM1576-ADJ series. This feature greatly simplifies the design of switch-mode power supplies.

Other features include a guaranteed $\pm 2\%$ tolerance on feedback voltage within specified input voltages and output load conditions, and $\pm 10\%$ on the oscillator frequency. External shutdown is included, featuring less than 200 μA standby current. The output switch includes cycle-by-cycle current limiting, as well as thermal shutdown for full protection under fault conditions.

Features

- Adjustable output, reference voltage $\pm 2\%$ max over line and load conditions
- Guaranteed 3A output current
- Wide input voltage range, 4V to 40V
- Wide output voltage range, 1.23V to 37V
- Requires only 6 external components
- 52 kHz fixed frequency internal oscillator
- Low power standby mode, I_Q typically $< 200 \mu\text{A}$
- Efficiency typically over 80%
- Uses readily available standard inductors
- Thermal shutdown and current limit protection
- 100% electrical thermal limit burn-in

Applications

- Simple high-efficiency step-down (buck) regulator
- Efficient pre-regulator for linear regulators
- On-card switching regulators
- Positive to negative converter (Inverting Buck-Boost)
- Isolated Flyback Converter using minimum number of external components
- Negative Boost Converter

Typical Application

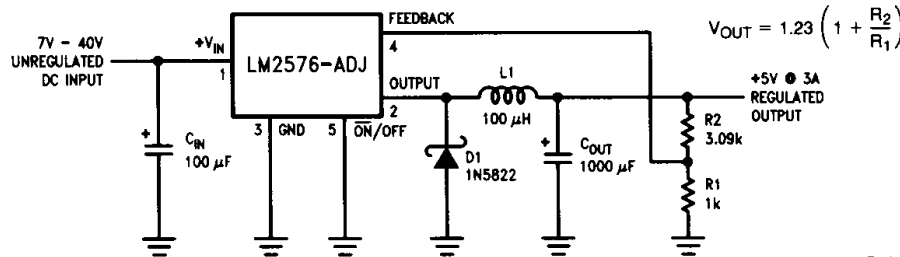

Note: Pin numbers are for TO-220 Package.

TL/H/11052-1

Connection Diagrams

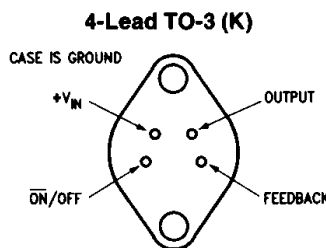

Bottom View

TL/H/11052-2

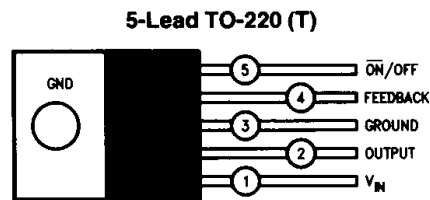

Top View

TL/H/11052-3

Order Number LM1576K-ADJ or LM2576K-ADJ
See NS Package Number K04A

Order Number LM2576T-ADJ
See NS Package Number T05A

For information about LM2576 in dual-in-line or surface-mount packages, contact a National Semiconductor sales office in your area.

Patent Pending
Simple Switcher™ is a trademark of National Semiconductor Corporation.

LM1576-ADJ/LM2576-ADJ Simple Switcher 3 Amp Step-Down Voltage Regulator

Absolute Maximum Ratings (Note 1)

If Military/Aerospace specified devices are required, please contact the National Semiconductor Sales Office/Distributors for availability and specifications.

Maximum Supply Voltage LM1576/LM2576	45V
$\overline{\text{ON}}$ /OFF Pin Input Voltage	$-0.3 \leq V \leq +40V$
Output Voltage to Ground (Steady State)	-1V
Power Dissipation	Internally Limited
Storage Temperature Range	-65°C to +150°C
Minimum ESD Rating (C = 100 pF, R = 1.5 k Ω)	2 kV
FB Pin (Pin 4)	1 kV

Lead Temperature
(Soldering, 10 sec.) 260°C

Operating Ratings

Maximum Junction Temperature	150°C
Temperature Range	
LM1576	$-55^\circ\text{C} \leq T_J \leq +150^\circ\text{C}$
LM2576	$-40^\circ\text{C} \leq T_J \leq +125^\circ\text{C}$
Supply Voltage LM1576/LM2576	40V

Electrical Characteristics Specifications with standard type face are for $T_J = 25^\circ\text{C}$, and those with **boldface** type apply over **full Operating Temperature Range**. Unless otherwise specified, $V_{\text{IN}} = 12V$, and $I_{\text{LOAD}} = 500 \text{ mA}$.

Symbol	Parameter	Conditions	Typ	LM1576-ADJ Limit (Note 2)	LM2576-ADJ Limit (Note 3)	Units (Limits)
SYSTEM PARAMETERS (Note 4) Test Circuit <i>Figure 1</i>						
V_{OUT}	Feedback Voltage	$V_{\text{IN}} = 12V, I_{\text{LOAD}} = 0.5A$ $V_{\text{OUT}} = 5V$, Circuit of <i>Figure 1</i>	1.230	1.217 1.243	1.217 1.243	V V(min) V(max)
V_{OUT}	Feedback Voltage	$0.5A \leq I_{\text{LOAD}} \leq 3A, 8V \leq V_{\text{IN}} \leq 40V$ $V_{\text{OUT}} = 5V$, Circuit of <i>Figure 1</i>	1.230	1.205/ 1.193 1.261/ 1.273	1.193/ 1.180 1.273/ 1.286	V V(min) V(max)
η	Efficiency	$V_{\text{IN}} = 12V, I_{\text{LOAD}} = 3A, V_{\text{OUT}} = 5V$	82			%
DEVICE PARAMETERS						
I_b	Feedback Bias Current	$V_{\text{OUT}} = 5V$	50	100/ 500	100/ 500	nA
f_O	Oscillator Frequency	(Note 10)	52	47/ 43 58/ 62	47/ 42 58/ 63	kHz kHz(min) kHz(max)
V_{SAT}	Saturation Voltage	$I_{\text{OUT}} = 3A$ (Note 5)	1.4	1.8/ 2.0	1.8/ 2.0	V V(max)
DC	Max Duty Cycle (ON)	(Note 6)	98	93	93	% %(min)
I_{CL}	Current Limit	Peak Current, $t_{\text{ON}} \leq 3 \mu\text{s}$ (Note 5)	5.8	4.2/ 3.5 6.9/ 7.5	4.2/ 3.5 6.9/ 7.5	A A(min) A(max)
I_L	Output Leakage Current	$V_{\text{IN}} = 40V$, (Note 7), Output = 0V Output = -1V Output = -1V	7.5	2 30	2 30	mA(max) mA mA(max)
I_Q	Quiescent Current	(Note 7)	5	10/ 12	10	mA mA(max)
I_{STBY}	Standby Quiescent Current	$\overline{\text{ON}}$ /OFF Pin = 5V (OFF)	50	200/ 500	200	μA μA (max)
θ_{JA} θ_{JC} θ_{JA} θ_{JA} θ_{JC}	Thermal Resistance	K Package, Junction to Ambient K Package, Junction to Case T Package, Junction to Ambient (Note 8) T Package, Junction to Ambient (Note 9) T Package, Junction to Case	35 1.5 65 45 2			$^\circ\text{C}/\text{W}$

Electrical Characteristics Specifications with standard type face are for $T_J = 25^\circ\text{C}$, and those with **boldface type** apply over **full Operating Temperature Range**. Unless otherwise specified, $V_{IN} = 12\text{V}$, and $I_{LOAD} = 500\text{ mA}$.
(Continued)

Symbol	Parameter	Conditions	Typ	LM1576-ADJ Limit (Note 2)	LM2576-ADJ Limit (Note 3)	Units (Limits)
ON/OFF CONTROL Test Circuit <i>Figure 1</i>						
V_{IH} V_{IL}	$\overline{\text{ON}}$ /OFF Pin Logic Input Level	$V_{OUT} = 0\text{V}$ $V_{OUT} = 5\text{V}$	1.4 1.2	2.2/2.4 1.0/0.8	2.2/2.4 1.0/0.8	V(min) V(max)
I_{IH}	$\overline{\text{ON}}$ /OFF Pin Input Current	$\overline{\text{ON}}$ /OFF Pin = 5V (OFF)	12	30	30	μA $\mu\text{A}(\text{max})$
I_{IL}		$\overline{\text{ON}}$ /OFF Pin = 0V (ON)	0	10	10	μA $\mu\text{A}(\text{max})$

Note 1: Absolute Maximum Ratings indicate limits beyond which damage to the device may occur. Operating Ratings indicate conditions for which the device is intended to be functional, but do not guarantee specific performance limits. For guaranteed specifications and test conditions, see the Electrical Characteristics.

Note 2: All limits guaranteed at room temperature (standard type face) and at **temperature extremes (bold type face)**. All limits are used to calculate Average Outgoing Quality Level, and all are 100% production tested.

Note 3: All limits guaranteed at room temperature (standard type face) and at **temperature extremes (bold type face)**. All room temperature limits are 100% production tested. All limits at **temperature extremes** are guaranteed via correlation using standard Statistical Quality Control (SQC) methods.

Note 4: External components such as the catch diode, inductor, input and output capacitors can affect switching regulator system performance. When the LM1576/LM2576 is used as shown in the *Figure 1* test circuit, system performance will be as shown in system parameters section of Electrical Characteristics.

Note 5: Output (pin 2) sourcing current. No diode, inductor or capacitor connected to output.

Note 6: Feedback (pin 4) removed from output and connected to 0V.

Note 7: Feedback (pin 4) removed from output and connected to 12V to force the output transistor OFF.

Note 8: Junction to ambient thermal resistance (no external heat sink) for the 5 lead TO-220 package mounted vertically, with $\frac{1}{2}$ " leads in a socket, or on a PC board with minimum copper area.

Note 9: Junction to ambient thermal resistance (no external heat sink) for the 5 lead TO-220 package mounted vertically, with $\frac{1}{4}$ " leads soldered to a PC board containing approximately 4 square inches of copper area surrounding the leads.

Note 10: The oscillator frequency reduces to approximately 18 kHz in the event of an output short or an overload which pulls the feedback voltage lower than 0.7V. This self-protection feature lowers the average power dissipation of the IC by reducing the minimum duty cycle from 5% to approximately 2%.

Typical Performance Characteristics (Circuit of *Figure 1*)

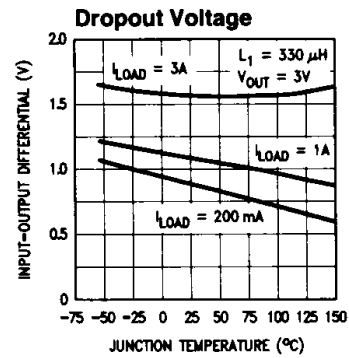
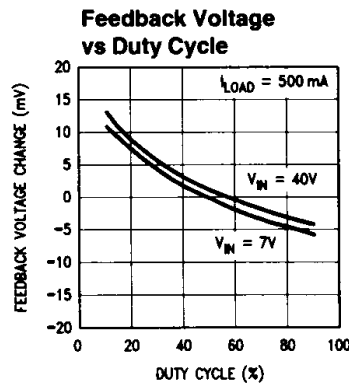
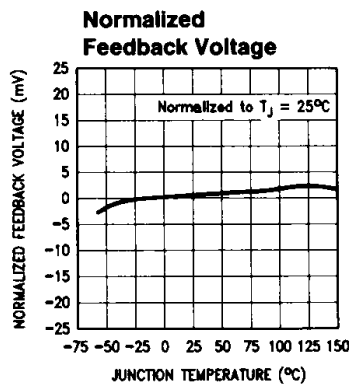

TL/H/11052-4

Typical Performance Characteristics (Circuit of Figure 1) (Continued)

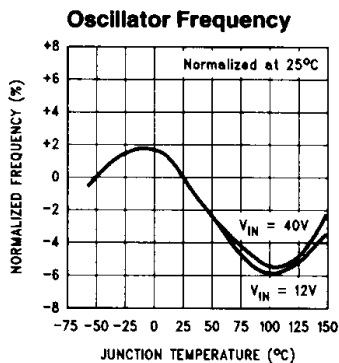
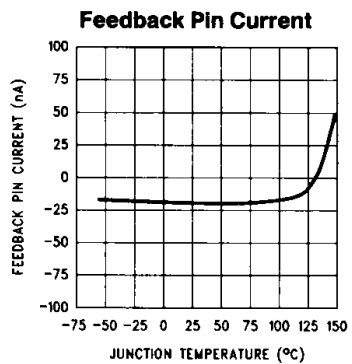
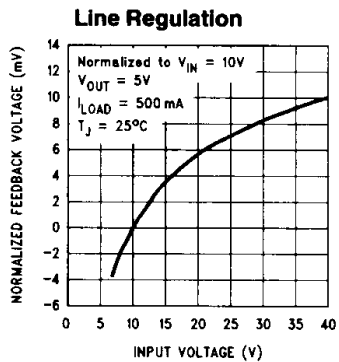
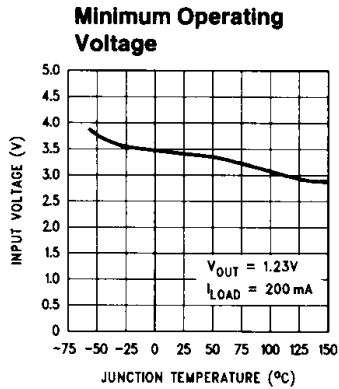
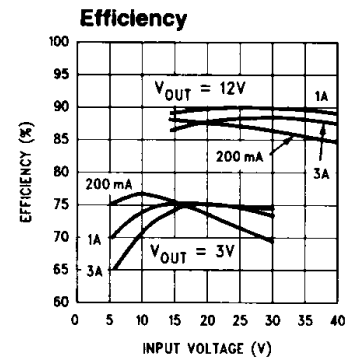
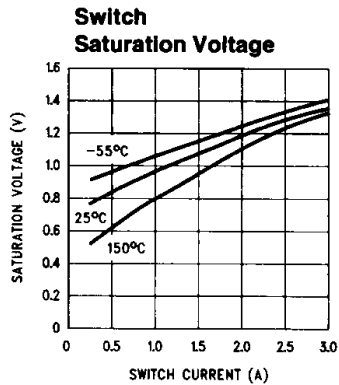
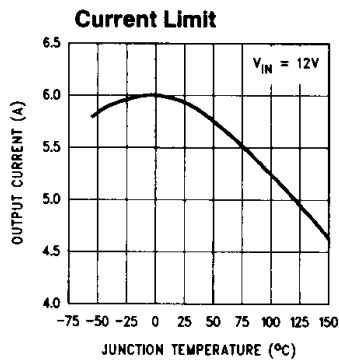
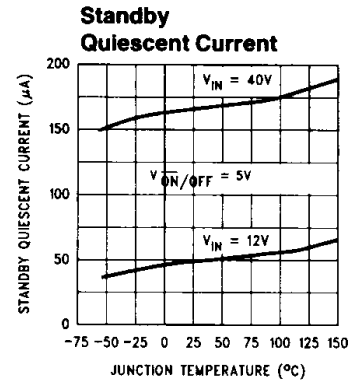
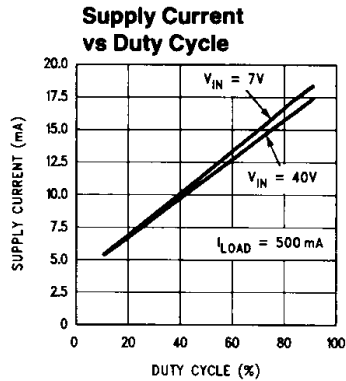
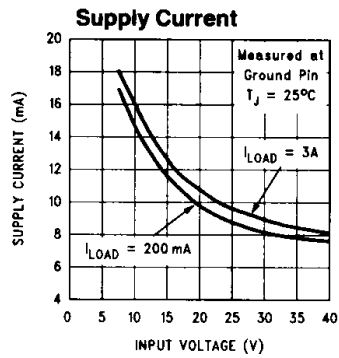

Typical Performance Characteristics (Circuit of Figure 1) (Continued)

Load Transient Response

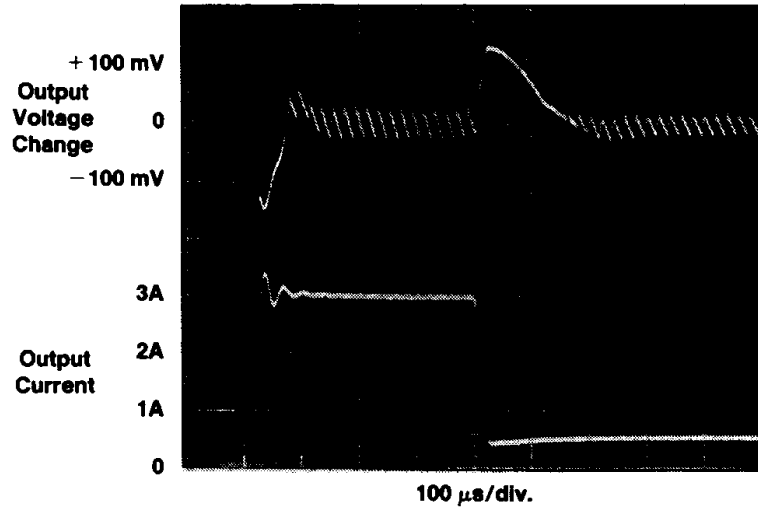

TL/H/11052-6

Switching Waveforms

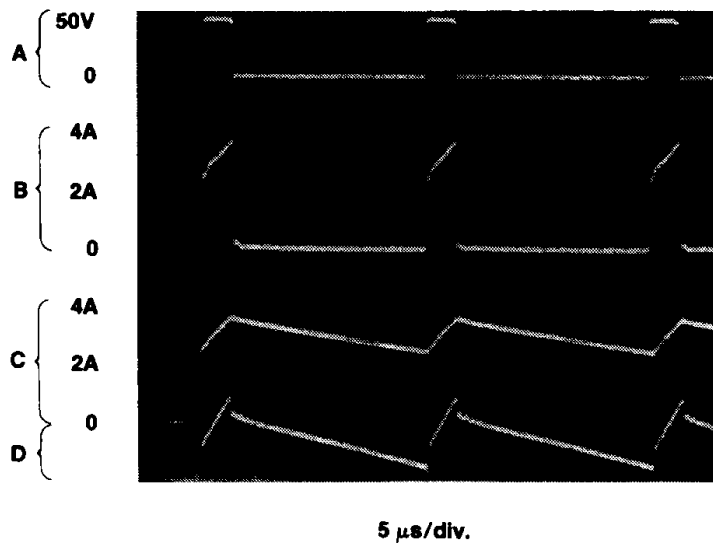

TL/H/11052-7

- A: Output pin voltage, 50V/div
 - B: Output pin current, 2A/div
 - C: Inductor current, 2A/div
 - D: Output ripple voltage, 50 mV/div, AC-coupled
- Horizontal Time Base: 5 μ s/div.

Test Circuit and Layout Guidelines

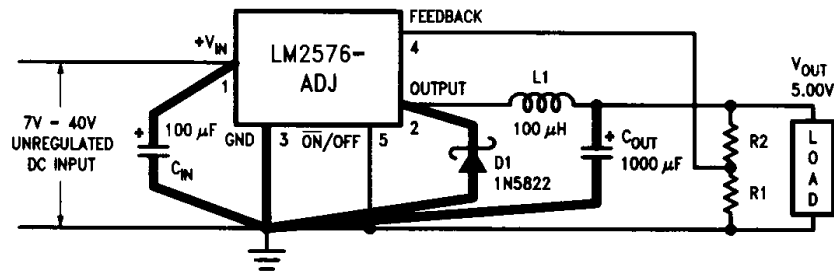

- C_{IN} — 100 μ F, 50V, Aluminum Electrolytic
- C_{OUT} — 1000 μ F, 15V, Aluminum Electrolytic
- D1 — Schottky, 1N5822
- L1 — 100 μ H, Pulse Eng. PE-92108
- R1 — 1k, 0.01%
- R2 — 3.065k, 0.01%

5-pin TO-220 socket—2936 (Loranger Mfg. Co.)
 4-pin TO-3 socket—8112-AG7 (Augat Inc.)

TL/H/11052-8

Note: Pin numbers are for the TO-220 package.

FIGURE 1

As in any switching regulator, layout is very important. Rapidly switching currents associated with wiring inductance generate voltage transients which can cause problems. For minimal stray inductance and ground loops, the length of the leads indicated by heavy lines should be kept as short as possible. Single-point grounding (as indicated) or ground plane construction should be used for best results.

Block Diagram and Typical Application

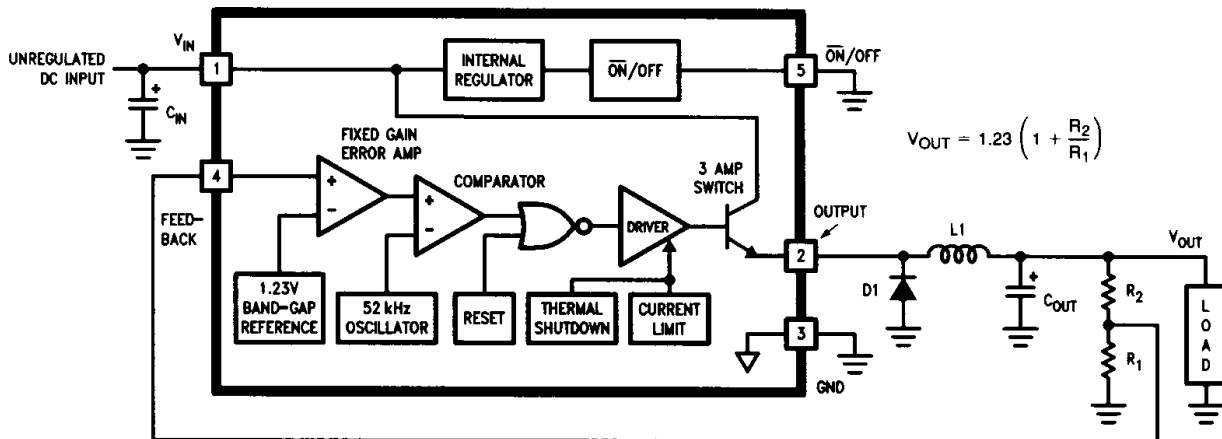

TL/H/11052-9

Note: Pin numbers are for the TO-220 package.

FIGURE 2

LM1576-ADJ Series Buck Regulator Design Procedure

Procedure	Example
<p>Given:</p> <p>V_{OUT} = Regulated Output Voltage $V_{IN(max)}$ = Maximum input voltage $I_{LOAD(max)}$ = Maximum load current F = Switching frequency (<i>fixed at 52 kHz</i>)</p> <p>1. Programming Output Voltage (selecting R_1 and R_2) Use the following formula to select the appropriate resistor values.</p> $V_{OUT} = V_{REF} \left(1 + \frac{R_2}{R_1} \right) \quad \text{where } V_{REF} = 1.23V$ <p>R_1 can be between 1k and 10k. (<i>for best temperature coefficient and stability with time, use 1% metal film resistors</i>)</p> $R_2 = R_1 \left(\frac{V_{OUT}}{V_{REF}} - 1 \right)$ <p>2. Inductor Selection (L1)</p> <p>A. Calculate $E \cdot T$ ($V \cdot \mu s$), from the following formula;</p> $E \cdot T = (V_{IN} - V_{OUT}) \frac{V_{OUT}}{V_{IN}} \cdot \frac{1000}{F(\text{in kHz})} (V \cdot \mu s)$ <p>B. Use the $E \cdot T$ value from the previous formula and match it with the $E \cdot T$ number on the vertical axis of the Inductor value selection guide shown in <i>Figure 4</i>.</p> <p>C. On the horizontal axis, select the maximum load current.</p> <p>D. Identify the region intersected by the $E \cdot T$ value and the maximum load current value, and note the inductor code for that region.</p> <p>E. Match Inductor code to the inductor value as shown in <i>Figure 5</i>. (<i>and manufacturer's part number</i>)</p> <p>3. Output Capacitor Selection (C_{OUT})</p> <p>The value of the output capacitor together with the inductor defines the dominant pole-pair of the switching regulator loop. For stable operation, the capacitor must satisfy the following requirement:</p> <p>A. $C_{OUT} \geq 13,300 \frac{V_{IN(max)}}{V_{OUT} \cdot L(\mu H)} (\mu F)$</p> <p>The above formula yields capacitor values between 10 μF and 2200 μF that will satisfy the loop requirements for stable operation. But to achieve an acceptable output ripple voltage (approximately 1% of the output voltage) and transient response, the output capacitor may need to be several times larger than the above formula yields.</p>	<p>Given:</p> <p>$V_{OUT} = 10V$ $V_{IN(max)} = 25V$ $I_{LOAD(max)} = 3A$ $F = 52 \text{ kHz}$</p> <p>1. Programming Output Voltage (selecting R_1 and R_2)</p> $V_{OUT} = 1.23 \left(1 + \frac{R_2}{R_1} \right) \quad \text{select } R_1 = 1k$ $R_2 = R_1 \left(\frac{V_{OUT}}{V_{REF}} - 1 \right) = 1k \left(\frac{10V}{1.23V} - 1 \right)$ $R_2 = 1k (8.13 - 1) = 7.13k, \text{ use closest 1\% value } 7.15k$ <p>2. Inductor Selection (L1)</p> <p>A. Calculate $E \cdot T$ ($V \cdot \mu s$)</p> $E \cdot T = (25 - 10) \cdot \frac{10}{25} \cdot \frac{1000}{52} = 115 V \cdot \mu s$ <p>B. $E \cdot T = 115 V \cdot \mu s$</p> <p>C. $I_{LOAD(max)} = 3A$</p> <p>D. Inductor code = H150</p> <p>E. Inductor value = 150 μH <i>Choose from AIE part #415-0936, Pulse Engineering part #PE-53115, or Renco part #RL2445.</i></p> <p>3. Output Capacitor Selection (C_{OUT})</p> <p>A. $C_{OUT} > 13,300 \frac{25}{10 \cdot 150} = 221 \mu F$</p> <p>However, for acceptable output ripple voltage select</p> $C_{OUT} \geq 680 \mu F$ <p>$C_{OUT} = 680 \mu F$ electrolytic Capacitor</p>

LM1576-ADJ Series Buck Regulator Design Procedure (Continued)

Procedure

The amount of output ripple voltage is primarily a function of the ESR (Equivalent Series Resistance) of the output capacitor. The value and the type of capacitor used will determine the amount of ESR it contains. Selecting a capacitor with a low ESR will result in a low output ripple voltage. In general, the lower capacitor values have the higher ESR ratings.

The lower capacitor values (220 μF –1000 μF) will allow typically 50 mV to 150 mV of output ripple voltage, while larger-value capacitors will reduce the ripple to approximately 35 mV to 50 mV.

$$V_{\text{RIPPLE p-p}} \geq 0.3 \times I_{\text{LOAD(max)}} \times \text{ESR}$$

To further reduce the output ripple voltage, several standard electrolytic capacitors may be paralleled, or a higher-grade capacitor may be used. Such capacitors are often called "high-frequency", "low-inductance", or "low-ESR". These will reduce the output ripple to 10 mV to 20 mV. However, reducing the ESR below 0.05 Ω can cause instability. For this reason, the use of a tantalum capacitor as the sole capacitor is not recommended. Tantalum capacitors (because of their good low temperature characteristics) can be used in parallel with aluminum electrolytics, with the tantalum making up 10% or 20% of the total capacitance.

The capacitor's ripple current rating at 52 kHz should be at least 50% higher than the ripple component of the inductor current.

$$I_{\text{RIPPLE(max)}} \geq 1.5 \times 0.3 \times I_{\text{LOAD(max)}}$$

B. The capacitor's voltage rating should be at least 1.25 times greater than the output voltage. For a 10V output, a rating of at least 15V is appropriate, and a 20V rating is recommended.

4. Catch Diode Selection (D1)

The catch-diode current rating must be at least 1.2 times greater than the maximum load current. Also, if the power supply design must withstand continuous shorted output conditions, the diode current rating should be greater than 3A. The most stressful condition for this diode is an overload or short circuit condition.

A. The reverse voltage rating of the diode should be at least 1.25 times the maximum input voltage.

B. Because of their fast switching speed and low forward voltage drop, Schottky diodes provide the best efficiency, especially in low output voltage switching regulators (less than 5V). Fast-Recovery, High-Efficiency, or Ultra-Fast Recovery diodes are also suitable, but some types with an abrupt turn-off characteristic may cause instability and EMI problems. A fast-recovery diode with soft recovery characteristics is a better choice. Standard 60 Hz diodes (e.g., 1N4001, or 1N5400, etc.) are also **not suitable**. See *Figure 3* for Schottky and "soft" fast-recovery diode selection guide.

Example

V_{IN} (max)	Schottky		Fast Recovery	
	3A	4A–6A	3A	4A–6A
20V	1N5820 MBR320P SR302	1N5823	The following diodes are all rated to 100V 31DF1 HER302	The following diodes are all rated to 100V 50WF10 MUR410 HER602
30V	1N5821 MBR330 31DQ03 SR303	50WQ03 31DQ03 1N5824		
40V	1N5822 MBR340 31DQ04 SR304	MBR340 31DQ04 50WQ04 1N5825		
50V	MBR350 31DQ05 SR305	50WQ05		
60V	MBR360	50WQ06		
	DQ06 SR306	50SQ060		

FIGURE 3. Diode Selection Guide

To further simplify the buck regulator design procedure, National Semiconductor is making available computer design software to be used with the Simple Switcher™ line of switching regulators. **Switchers Made Simple** is available on a (5¼") diskette for IBM compatible computers from a National Semiconductor sales office in your area.

LM1576-ADJ Series Buck Regulator Design Procedure (Continued)

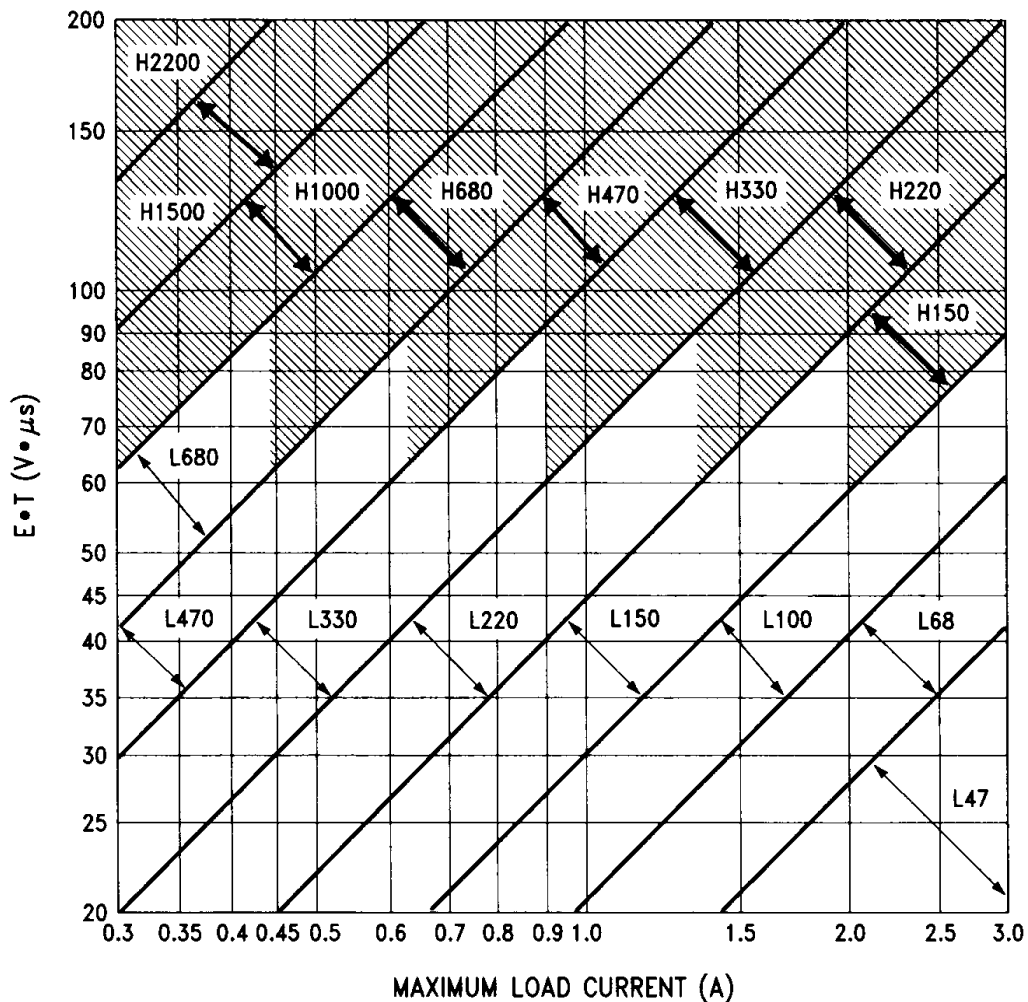

FIGURE 4. Inductor Value Selection Guide (for Continuous Mode Operation)

TL/H/11052-10

Inductor Code	Inductor Value	AIE ¹	Pulse Eng. ²	Renco ³
L47	47 μH	415-0932	PE-53112	RL2442
L68	68 μH	415-0931	PE-92114	RL2443
L100	100 μH	415-0930	PE-92108	RL2444
L150	150 μH	415-0953	PE-53113	RL1954
L220	220 μH	415-0922	PE-52626	RL1953
L330	330 μH	415-0926	PE-52627	RL1952
L470	470 μH	415-0927	PE-53114	RL1951
L680	680 μH	415-0928	PE-52629	RL1950
H150	150 μH	415-0936	PE-53115	RL2445
H220	220 μH	430-0636	PE-53116	RL2446
H330	330 μH	430-0635	PE-53117	RL2447
H470	470 μH	430-0634	PE-53118	RL1961
H680	680 μH	415-0935	PE-53119	RL1960
H1000	1000 μH	415-0934	PE-53120	RL1959
H1500	1500 μH	415-0933	PE-53121	RL1958
H2200	2200 μH	415-0945	PE-53122	RL2448

Note 1: AIE Magnetics, div. Vernatron Corp. Passive Components Group, (813) 347-2181, 2801 72nd Street North, St. Petersburg, FL 33710

Note 2: Pulse Engineering, (619) 268-2400, P.O. Box 12235, San Diego, CA 92112

Note 3: Renco Electronics Inc., (516) 586-5566, 60 Jeffryn Blvd. East, Deer Park, NY 11729

FIGURE 5. Inductor Selection by Manufacturer's Part Number

Typical Applications

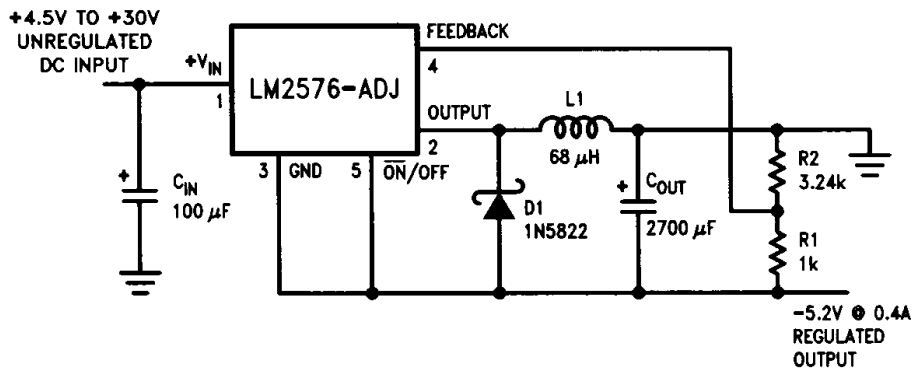

FIGURE 6. Inverting Buck-Boost

TL/H/11052-11

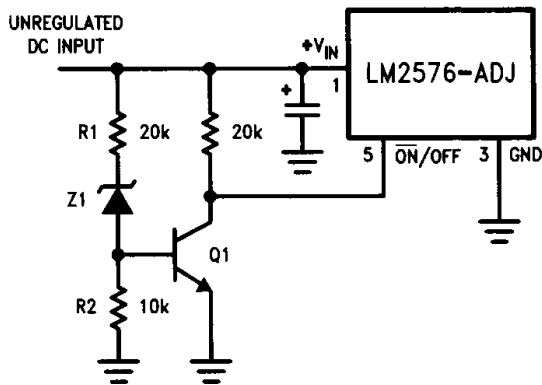

FIGURE 7. Undervoltage Lockout

TL/H/11052-12

Figure 6 shows an LM2576-ADJ in a very simple buck-boost configuration to generate a negative 5.2V output, from a positive input voltage. This circuit bootstraps the regulator's ground pin to the negative output voltage, then by grounding the feedback pin, the regulator senses the inverted output voltage and regulates it to $-5.2V$.

The maximum available output current in this configuration is approximately 0.4A. Higher currents (up to 0.7A) are possible with input voltages greater than 8V, or by increasing the value of the output capacitor.

The pulsed switch currents in this buck-boost configuration are higher than in the standard buck-mode design. To avoid

exceeding the maximum switch current rating, the available output current is less than the standard buck configuration. Also, the Start-up input current is higher than the standard buck-mode regulator, and this could overload the input power source. Using a delayed turn-on or an undervoltage lock-out circuit would allow the input voltage to rise to a high enough level before the switcher would be allowed to turn on. The circuit in Figure 7 can be modified for the buck-boost under-voltage lockout by wiring the emitter of Q1 and the low side of R1, to the ground pin of the LM2576, which is the negative output of the inverting buck-boost circuit.

The buck regulator design procedure section can not be used to select the inductor, because of the structural differences between the buck and the buck-boost regulator topologies. The recommended range of inductor values for the buck-boost designs is between $47 \mu H$ and $200 \mu H$.

In some applications it is desirable to keep the regulator off until the input voltage reaches a certain threshold. An undervoltage lockout circuit which accomplishes this task is shown in Figure 7. This circuit keeps the regulator off until the input voltage reaches a predetermined level.

$$V_{TH} \approx V_{Z1} + V_{BE}(Q1)$$

A 3A power supply that features an adjustable output voltage is shown in Figure 8. An additional L-C filter that reduces the output ripple by a factor of 10 or more, to about 5 mV, is included in this circuit.

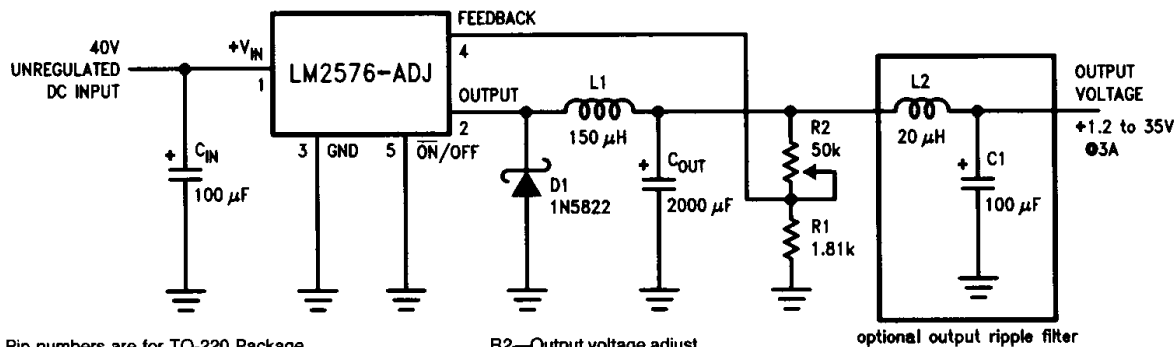

Note: Pin numbers are for TO-220 Package.

R2—Output voltage adjust

optional output ripple filter

FIGURE 8. 1.2V to 35V Adjustable 3A Power Supply with Low Output Ripple

TL/H/11052-13

Application Hints

INPUT CAPACITOR (C_{IN})

Because of higher switching currents, input supply bypassing is more important in the LM2576 than in the LM2575. To maintain stability, the regulator input pin must be bypassed with at least a 47 μ F low-ESR electrolytic capacitor. Capacitors with high voltage ratings, or capacitors which are physically larger, generally have a lower ESR. The capacitor's leads must be kept short, and located as close as possible to the regulator.

If the operating temperature range includes temperatures below -25°C , the input capacitor value may need to be larger. With most electrolytic capacitors, the capacitance value decreases and the ESR increases with lower temperatures and age. Adding a ceramic or solid tantalum capacitor near the input pin will increase the regulator stability at cold temperatures. For maximum capacitor operating lifetime, the capacitor's RMS ripple current rating should be greater than $1.2 \times (t_{ON}/T) \times I_{LOAD}$.

INDUCTOR SELECTION

The inductor value selection guide of *Figure 4* was designed for buck regulator designs of the continuous inductor current type. When using inductor values shown in the inductor selection guide, the peak-to-peak inductor ripple current will be approximately 20% to 30% of the maximum DC current. With relatively heavy load currents, the circuit operates in the continuous mode (inductor current always flowing), but under light load conditions, the circuit will be forced to the discontinuous mode (inductor current falls to zero for a period of time). This discontinuous mode of operation is perfectly acceptable. For light loads (less than approximately 300 mA) it may be desirable to operate the regulator in the discontinuous mode, primarily because of the lower inductor values required for the discontinuous mode.

The LM2576 can be used for both continuous and discontinuous modes of operation. The selection guide chooses inductor values suitable for continuous mode operation, but if the inductor value chosen is prohibitively high, the designer should investigate the possibility of discontinuous operation. The computer design software *Switchers Made Simple* will provide all component values for discontinuous (as well as continuous) mode of operation.

Inductors are available in different styles such as pot core, toroid, E-frame, bobbin core, etc., as well as different core materials, such as ferrites and powdered iron. The least expensive, the bobbin core type, consists of wire wrapped on a ferrite rod core. This type of construction makes for an inexpensive inductor, but since the magnetic flux is not completely contained within the core, it generates more electromagnetic interference (EMI). This EMI can cause problems in sensitive circuits, or can give incorrect scope readings because of induced voltages in the scope probe.

The inductors listed in the selection chart include ferrite pot core construction for AIE, powdered iron toroid for Pulse Engineering, and ferrite bobbin core for Renco.

An inductor should not be operated beyond its maximum rated current because it may saturate. When an inductor begins to saturate, the inductance decreases rapidly and the inductor begins to look mainly resistive (the DC resistance of the winding). This can cause the switch current to

rise very rapidly and the switch may not be able to turn off fast enough to protect itself from excessive current. Different inductor types have different saturation characteristics, and this should be kept in mind when selecting an inductor. The inductor manufacturers' data sheets include current and energy limits to avoid inductor saturation.

OUTPUT VOLTAGE RIPPLE AND TRANSIENTS

The output voltage of a switching power supply will contain a sawtooth ripple voltage at the switcher frequency, and may also contain short voltage spikes at the peaks of the sawtooth waveform.

The output ripple voltage is due mainly to the inductor sawtooth ripple current multiplied by the ESR of the output capacitor (see Section 3A of design procedure).

The voltage spikes are present because of the fast switching action of the output switch, and the parasitic inductance of the output filter capacitor. To minimize these voltage spikes, special low inductance capacitors must be used, and their lead lengths must be kept short. Wiring inductance, stray capacitance, as well as the scope probe used to evaluate these transients, all contribute to the amplitude of these spikes.

An additional small LC filter can be added to the output to further reduce the amount of output ripple and transients, as in *Figure 8*.

FEEDBACK CONNECTION

The LM2576-ADJ feedback circuitry is designed so that, when the output voltage is connected directly to the Feedback pin, the output voltage is 1.230V.

ON/OFF INPUT

For normal operation, the $\overline{\text{ON/OFF}}$ pin should be grounded or driven with a low-level TTL voltage (typically below 1.6V). To put the regulator into standby mode, drive this pin with a high-level TTL or CMOS signal.

GROUNDING

To maintain output voltage stability, the power ground connections must be low-impedance (see *Figure 1*). For the TO-3 style package, the case is ground. For the 5-lead TO-220 style package, both the tab and pin 3 are ground and either connection may be used, as they are both part of the same copper lead frame.

HEAT SINK/THERMAL CONSIDERATIONS

In many cases, only a small heat sink is required to keep the LM2576 junction temperature within the allowed operating range. For each application, to determine whether or not a heat sink will be required, the following must be identified:

1. Maximum ambient temperature (in the application).
2. Maximum regulator power dissipation (in application).
3. Maximum allowed junction temperature (150°C for LM1576 or 125°C for the LM2576). For a safe, conservative design, a temperature approximately 15°C cooler than the maximum temperatures should be selected.
4. LM2576 package thermal resistances θ_{JA} and θ_{JC} .

Total power dissipated by the LM2576 can be estimated as follows:

$$P_D = (V_{IN}) (I_Q) + (V_O/V_{IN}) (I_{LOAD}) (V_{SAT})$$

Application Hints (Continued)

where I_Q (quiescent current) and V_{SAT} can be found in the Characteristic Curves shown previously, V_{IN} is the applied minimum input voltage, V_O is the regulated output voltage, and I_{LOAD} is the load current. The dynamic losses during turn-on and turn-off are negligible if a Schottky type catch diode is used.

When no heat sink is used, the junction temperature rise can be determined by the following:

$$\Delta T_J = (P_D)(\theta_{JA})$$

To arrive at the actual operating junction temperature, add the junction temperature rise to the maximum ambient temperature.

$$T_J = \Delta T_J + T_A$$

If the actual operating junction temperature is greater than the selected safe operating junction temperature determined in step 3, then a heat sink is required.

When using a heat sink, the junction temperature rise can be determined by the following:

$$\Delta T_J = (P_D)(\theta_{JC} + \theta_{interface} + \theta_{Heat\ sink})$$

The operating junction temperature will be:

$$T_J = T_A + \Delta T_J$$

As above, if the actual operating junction temperature is greater than the selected safe operating junction temperature, then a larger heat sink is required (one that has a lower thermal resistance).

Included on the **Switcher Made Simple** design software is a more precise (non-linear) thermal model that can be used to determine junction temperature with different input-output parameters or different component values. It can also calculate the heat sink thermal resistance required to maintain the regulators junction temperature below the maximum operating temperature.

Definition of Terms

BUCK REGULATOR

A switching regulator topology in which a higher voltage is converted to a lower voltage. Also known as a step-down switching regulator.

BUCK-BOOST REGULATOR

A switching regular topology in which a positive voltage is converted to a negative voltage without a transformer.

DUTY CYCLE (D)

Ratio of the output switch's on-time to the oscillator period.

$$\text{for buck regulator} \quad D = \frac{t_{ON}}{T} = \frac{V_{OUT}}{V_{IN}}$$

$$\text{for buck-boost regulator} \quad D = \frac{t_{ON}}{T} = \frac{|V_O|}{|V_O| + V_{IN}}$$

where T is the oscillator period, typically 1/52 kHz or 19 μ s.

CATCH DIODE OR CURRENT STEERING DIODE

The diode which provides a return path for the load current when the LM2576 switch is OFF.

EFFICIENCY (η)

The proportion of input power actually delivered to the load.

$$\eta = \frac{P_{OUT}}{P_{IN}} = \frac{P_{OUT}}{P_{OUT} + P_{LOSS}}$$

EQUIVALENT SERIES INDUCTANCE (ESL)

The pure inductance component of a capacitor (see *Figure 9*). The amount of inductance is determined to a large extent on the capacitor's construction. In a buck regulator, this unwanted inductance causes voltage spikes to appear on the output.

EQUIVALENT SERIES RESISTANCE (ESR)

The purely resistive component of a real capacitor's impedance (see *Figure 9*). It causes power loss resulting in capacitor heating, which directly affects the capacitor's operating lifetime. When used as a switching regulator output filter, higher ESR values result in higher output ripple voltages.

Most standard aluminum electrolytic capacitors in the 470 μ F–2000 μ F range have 0.05 Ω to 0.3 Ω ESR. Higher-grade capacitors ("low-ESR", "high-frequency", or "low-inductance") in the 220 μ F–1000 μ F range generally have ESR of less than 0.15 Ω .

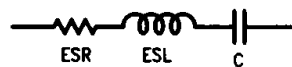

TL/H/11052-14

FIGURE 9. Simple Model of a Real Capacitor

OUTPUT RIPPLE VOLTAGE

The AC component of the switching regulator's output voltage. It is usually dominated by the output capacitor's ESR multiplied by the inductor's ripple current. The peak-to-peak value of this sawtooth ripple current will be typically 30% of the maximum load current (when the Design Procedure in the datasheet is followed).

CAPACITOR RIPPLE CURRENT

RMS value of the maximum allowable alternating current at which a capacitor can be operated continuously at a specified temperature.

STANDBY QUIESCENT CURRENT (I_{STBY})

Supply current required by the LM2576 when in the standby mode (\overline{ON}/OFF pin is driven to TTL-high voltage), thus turning the output switch OFF.

INDUCTOR RIPPLE CURRENT

The peak-to-peak value of the inductor current waveform, typically a sawtooth waveform when the regulator is operating continuous (vs. discontinuous)

CONTINUOUS/DISCONTINUOUS MODE OF OPERATION

Relates to the inductor current. In the continuous mode, the inductor current is always flowing and never drops to zero, vs. the discontinuous mode, where the inductor current drops to zero for a period of time.

INDUCTOR SATURATION

The condition which exists when an inductor cannot hold any more magnetic flux. When an inductor saturates, the inductor appears less inductive and the resistive component dominates. Inductor current is then limited only by the DC resistance of the wire and the available source current.

Physical Dimensions inches (millimeters)

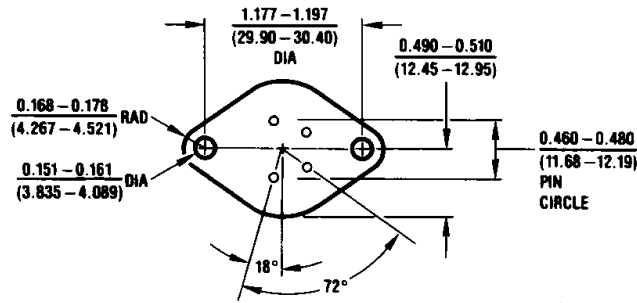
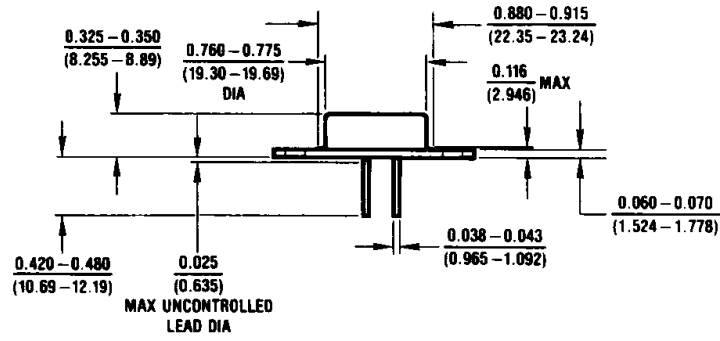

K04A (REV E)

4-Lead TO-3 (K)
Order Number LM1576K-ADJ or LM2576K-ADJ
NS Package Number K04A

Physical Dimensions inches (millimeters) (Continued)

Lit #107462

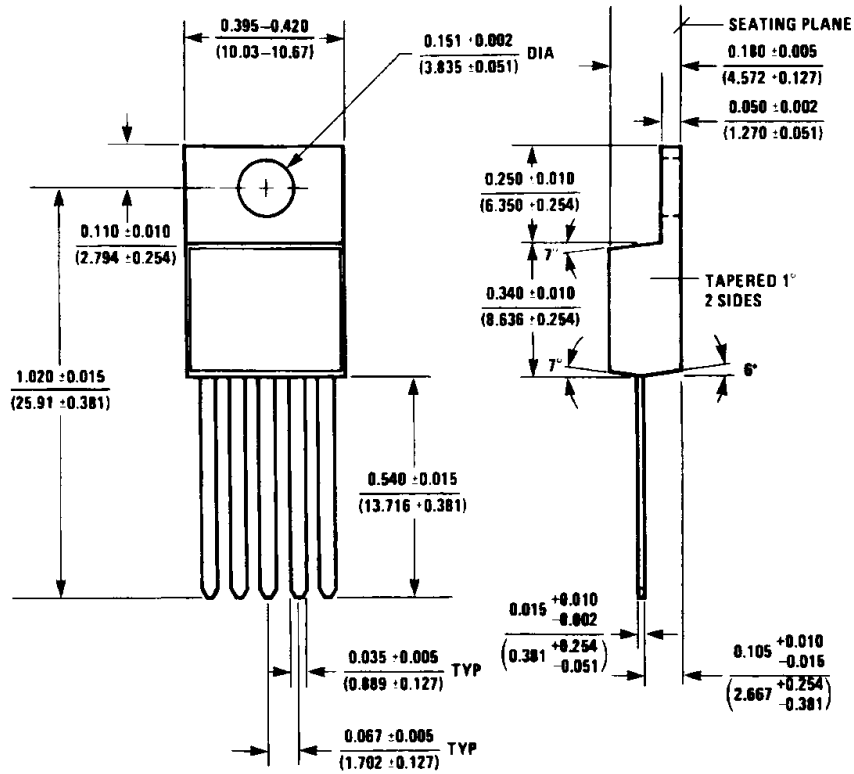

106A (REV H)

5-Lead TO-220 (T)
Order Number LM2576T-ADJ
NS Package Number T05A

LIFE SUPPORT POLICY

NATIONAL'S PRODUCTS ARE NOT AUTHORIZED FOR USE AS CRITICAL COMPONENTS IN LIFE SUPPORT DEVICES OR SYSTEMS WITHOUT THE EXPRESS WRITTEN APPROVAL OF THE PRESIDENT OF NATIONAL SEMICONDUCTOR CORPORATION. As used herein:

1. Life support devices or systems are devices or systems which, (a) are intended for surgical implant into the body, or (b) support or sustain life, and whose failure to perform, when properly used in accordance with instructions for use provided in the labeling, can be reasonably expected to result in a significant injury to the user.
2. A critical component is any component of a life support device or system whose failure to perform can be reasonably expected to cause the failure of the life support device or system, or to affect its safety or effectiveness.

JAN 13 1992

Handwritten signature and initials: *[Signature]* ✓ *R*



National Semiconductor Corporation
 2900 Semiconductor Drive
 P.O. Box 58090
 Santa Clara, CA 95052-8090
 Tel: (408) 721-5000
 TWX: (910) 339-9240

National Semiconductor GmbH
 Industriestrasse 10
 D-8080 Furstenfeldbruck
 West Germany
 Tel: (0-81-41) 103-0
 Telex: 527-649
 Fax: (08141) 103554

National Semiconductor Japan Ltd.
 Sanseido Bldg. 5F
 4-15 Nishi Shinjuku
 Shinjuku-Ku,
 Tokyo 160, Japan
 Tel: 3-299-7001
 FAX: 3-299-7000

National Semiconductor Hong Kong Ltd.
 Suite 513, 5th Floor
 Chinachem Golden Plaza,
 77 Mody Road, Tsimshatsui East,
 Kowloon, Hong Kong
 Tel: 3-7231290
 Telex: 52996 NSSEA HX
 Fax: 3-3112536

National Semicondutores Do Brasil Ltda.
 Av. Brig. Faria Lima, 1383
 6.0 Andor-Conj. 62
 01451 Sao Paulo, SP, Brasil
 Tel: (55/11) 212-5066
 Fax: (55/11) 211-1181 NSBR BR

National Semiconductor (Australia) PTY, Ltd.
 1st Floor, 441 St. Kilda Rd.
 Melbourne, 3004
 Victoria, Australia
 Tel: (03) 267-5000
 Fax: 61-3-2677458

Copyright © Each Manufacturing Company.

All Datasheets cannot be modified without permission.

This datasheet has been download from :

www.AllDataSheet.com

100% Free DataSheet Search Site.

Free Download.

No Register.

Fast Search System.

www.AllDataSheet.com