

## Single Operational Amplifiers

**TBA 221; TBB 741**  
**TBA 222; TBB 742**

1

### Features

- NPN input
- High differential input voltage
- Short-circuit proof
- High voltage gain
- High supply voltage 44 V
- Wide temperature range (TBA 222, TBB 742)
- Push-pull output
- B S1-version for high quality

Bipolar IC

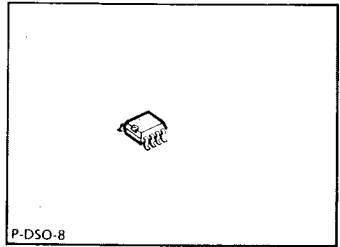
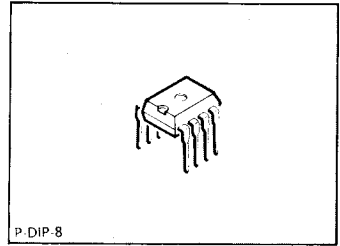

### Applications

- Amplifier
- Comparator

Type	Ordering Code	Package	Color Code
☐ TBA 221 B	Q67000-A281	P-DIP-8	—
☐ TBA 222 B	Q67000-A2280	P-DIP-8	—
TBA 222 B S1	Q67000-A8057	P-DIP-8	—
■ ☐ TBB 741 G	Q67000-A1498	P-DSO-8 (SMD)	blue/brown
■ ☐ TBB 742 G	Q67000-A2395-G403	P-DSO-8 (SMD)	red/green

■ = Not for new design

These op amps are short-circuit proof to  $+V_S$ ,  $-V_S$ . The input offset voltage can be very easily compensated. Very few external components are required due to the internal frequency compensation. The gain reduction by 6 dB/octave yields a very good stability.

**Circuit Diagram**

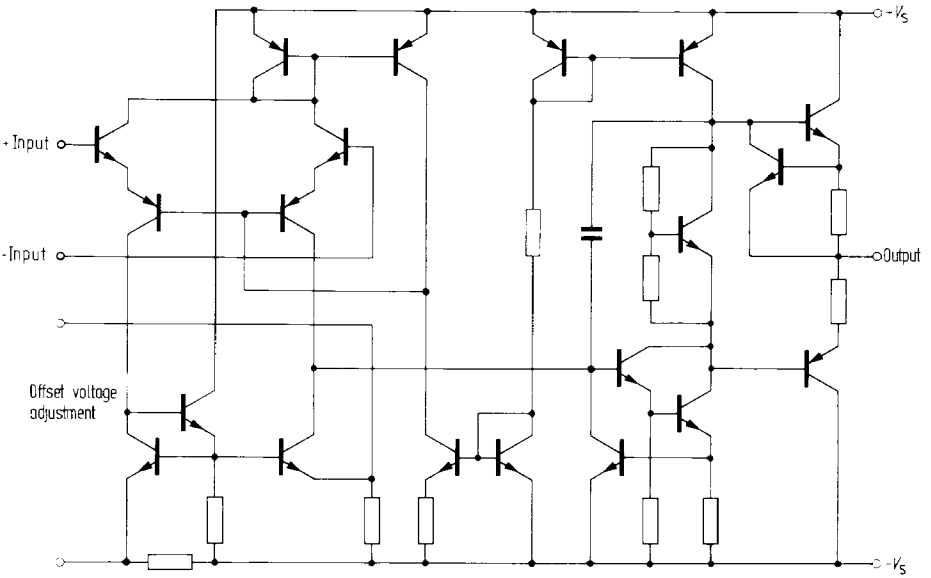

**Pin Configurations**  
(top view)

**TBA 221 B**  
**TBA 222 B**  
**TBA 222 B S1**

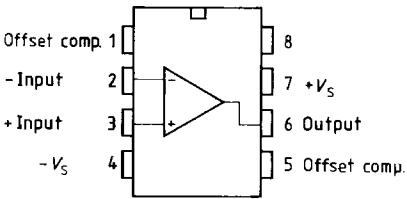

**TBB 741 G**  
**TBB 742 G**

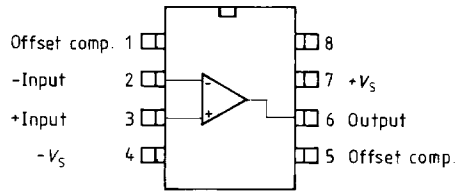

### Absolute Maximum Ratings

Parameter	Symbol	Limit Values		Unit	
		TBA 221 TBB 741	TBA 222 TBB 742		
Supply voltage	$V_S$	$\pm 18$	$\pm 22$	V	
Input voltage: $V_S = \pm 4$ to $\pm 15$ V $V_S \geq 15$ V	$V_I$	$\pm V_S$	$\pm V_S$	V	
	$V_I$	$\pm 15$	$\pm 15$	V	
Differential input voltage	$V_{ID}$	$\pm 30$	$\pm 30$	V	
Output short-circuit duration <sup>1)</sup>	$t_{QSC}$	$\infty$	$\infty$		
Junction temperature	$T_j$	150	150	°C	
Storage temperature range	$T_{stg}$	-55 to 125	-65 to 125	°C	
Thermal resistance system – air	TBA 221B/222B; BS1 TBB 741 G/742 G	$R_{th SA}$	100	100	K/W
		$R_{th SA}$	200	200	K/W

1) Short circuit may be to  $+V_S$ ,  $-V_S$ , or 0, whereby maximum ratings like  $T_j$  must not be exceeded.

### Operating Range

Supply voltage	$V_S$	$\pm 4$ to $\pm 18$	$\pm 4$ to $\pm 22$	V
Ambient temperature	$T_A$	0 to 70	-55 to 125	°C

### Characteristics

$V_S = \pm 15$  V

Parameter	Symbol	Limit Values $T_A = 25$ °C			Limit Values $T_A = 0$ °C to 70 °C		Unit
		min.	typ.	max.	min.	max.	
Input offset voltage	$V_{IO}$	-6		6	-7.5	7.5	mV
$R_G \leq 10$ k $\Omega$							
Setting range of $V_{IO}$	$V_{IO}$	6	$\pm 15$	-6			mV
Input offset current	$I_{IO}$	-200	$\pm 20$	200	-300	300	nA
Input current	$I_I$		80	500		800	nA
Supply current	$I_S$		1.7	2.8		2.8	mA
Pos. output short-circuit current	$I_{QSC+}$	15	20	25			mA
Neg. output short-circuit current	$I_{QSC-}$	-25	-20	-15			mA
Input resistance	$R_I$	300	2000				k $\Omega$
Input capacitance	$C_I$		1.4				pF
Output resistance	$R_O$		75				$\Omega$
Control range							
$R_G \geq 10$ k $\Omega$	$V_{Q PP}$	13	$\pm 14$	-12.5			V
$R_L \geq 2$ k $\Omega$	$V_{Q PP}$	11	$\pm 13$	-11			V
Common-mode input voltage range	$V_{IC}$	$-V_S + 3$		$V_S - 3$			V

**Characteristics**

$V_S = \pm 15\text{ V}$

Parameter	Symbol	Limit Values $T_A = 25\text{ }^\circ\text{C}$			Limit Values $T_A = 0\text{ }^\circ\text{C}$ to $70\text{ }^\circ\text{C}$		Unit
		min.	typ.	max.	min.	max.	
Open-loop voltage gain $V_{O\text{ pp}} = \pm 10\text{ V}$ , $R_L \geq 2\text{ k}\Omega$	$G_{VO}$	86	100		84		dB
Common-mode rejection ( $R_G \leq 10\text{ k}\Omega$ )	$K_{CMR}$	70	90				dB
Supply voltage rejection	$k_{SVR}$		30	150			$\mu\text{V/V}$
Transient response of output voltage at $G_V = 1$ : Rise time, $V_I = 20\text{ mV}$ , $R_L = 2\text{ k}\Omega$ ; $C_L \leq 100\text{ pF}$	$t_r$		0.3				$\mu\text{s}$
Overshoot			5				%
Slew rate <sup>1)</sup> $R_L \leq 2\text{ k}\Omega$	SR		0.5				$\text{V}/\mu\text{s}$
Temperature coefficient of $V_{IO}$	$\alpha_{VIO}$		3				$\mu\text{V/K}$
Temperature coefficient of $I_{IO}$	$\alpha_{IIO}$		0.4				$\text{nA/K}$

**Characteristics (TBA 222, TBB 742)**

$V_S = \pm 15\text{ V}$

Input offset voltage $R_G \leq 10\text{ k}\Omega$	$V_{IO}$	-4		4	-5.5	5.5	mV
Setting range of $V_{IO}$	$V_{IO}$	6	$\pm 15$	-6			mV
Input offset current	$I_{IO}$	-100	$\pm 20$	100	-400	400	nA
Input current	$I_I$		80	350		1200	nA
Supply current	$I_S$		1.7	2.8		2.8	mA
Pos. output short-circuit current	$I_{QSC+}$	15	20	25			mA
Neg. output short-circuit current	$I_{QSC-}$	-25	-20	-15			mA
Input resistance	$R_I$	300	2000				$\text{k}\Omega$
Input capacitance	$C_I$		1.4				pF
Output resistance	$R_Q$		75				$\Omega$
Control range $R_L \geq 10\text{ k}\Omega$ $R_L \geq 2\text{ k}\Omega$	$V_{O\text{ pp}}$ $V_{Q\text{ pp}}$	13 11	$\pm 14$ $\pm 13$	-12.5 -11			V V
Common-mode input voltage range	$V_{IC}$	$-V_S+3$		$V_S-3$			V
Open-loop voltage gain $V_{O\text{ pp}} = \pm 10\text{ V}$ , $R_L \geq 2\text{ k}\Omega$	$G_{VO}$	94	106		88		dB
Common-mode rejection $R_G \leq 10\text{ k}\Omega$	$K_{CMR}$	80	90				dB
Supply voltage rejection	$k_{SVR}$		30	100			$\mu\text{V/V}$

1) For the relationship between power bandwidth and slew rate refer to "Introduction – Operational Amplifiers"

**Characteristics (TBA 222, TBA 742)**

$V_S = \pm 15\text{ V}$

Parameter	Symbol	Limit Values $T_A = 25^\circ\text{C}$			Limit Values $T_A = 0^\circ\text{C}$ to $70^\circ\text{C}$		Unit
		min.	typ.	max.	min.	max.	
Transient response of output voltage at $G_V = 1$ : Rise time, $V_i = 20\text{ mV}$ , $R_L = 2\text{ k}\Omega$ , $C_L \leq 100\text{ pF}$	$t_r$		0.3				$\mu\text{s}$
Overshoot			5				%
Slew rate <sup>1)</sup> $R_L \leq 2\text{ k}\Omega$	SR		0.5				$\text{V}/\mu\text{s}$
Temperature coefficient of $V_{IO}$	$\alpha_{VIO}$		3				$\mu\text{V}/\text{K}$
Temperature coefficient of $I_{IO}$	$\alpha_{IIO}$		0.4				$\text{nA}/\text{K}$

**TBA 222 B S1**

The TBA 222 B S1 is similar to TBA 222 B, however, with special quality features.

- 72 hours electrically preaged at  $T_A = 50^\circ\text{C}$ ,  $V_S \pm 22\text{ V}$  corresponding to the circuit shown below
- Noise  $< 5\ \mu\text{Vs}$  in accordance with DIN 45405

**Circuit, Preageing for TBA 222 B S1**

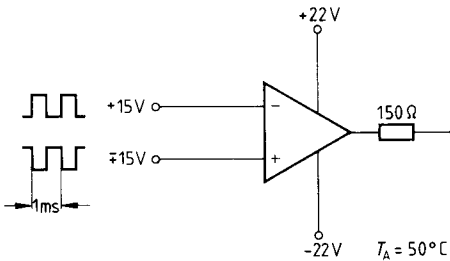

<sup>1)</sup> For the relationship between power bandwidth and slew rate refer to “**Introduction – Operational Amplifier**”

**Open-loop voltage gain versus supply voltage**

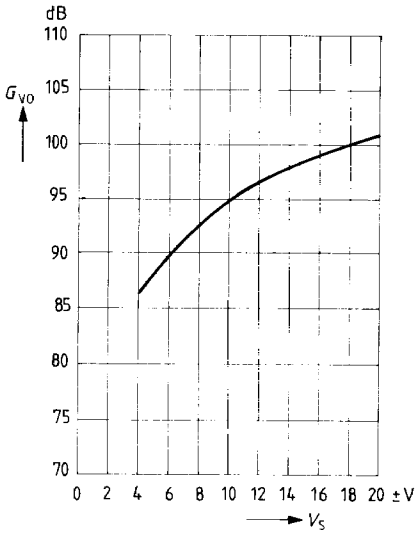

**Output voltage versus supply voltage**

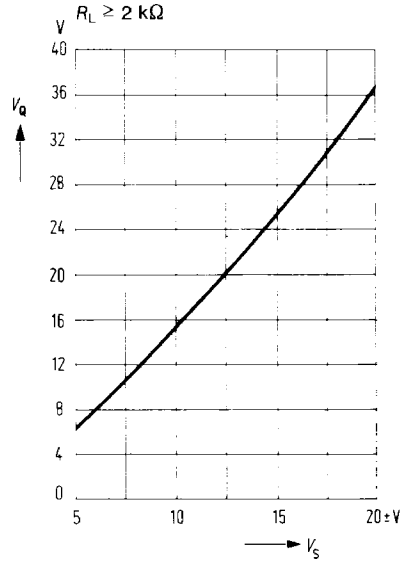

**Common-mode range versus supply voltage**

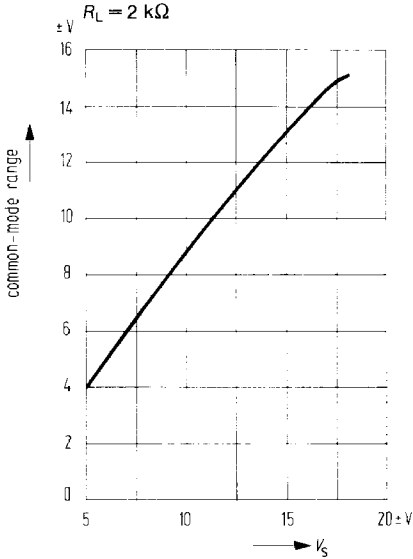

**Output short-circuit current versus ambient temperature**

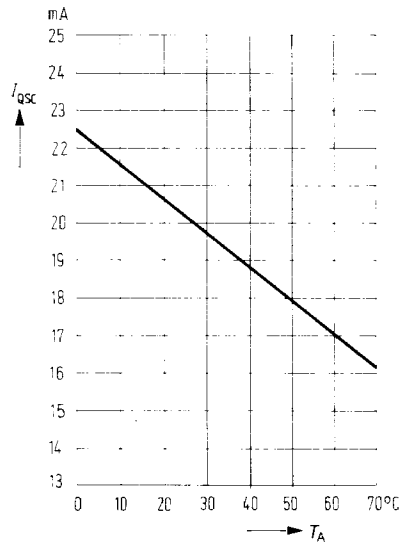

**Input current versus ambient temperature**  
 $V_S = \pm 15\text{ V}$

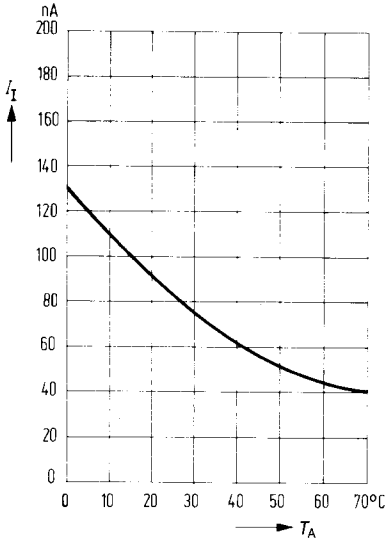

**Input resistance versus ambient temperature**  
 $V_S = \pm 15\text{ V}$

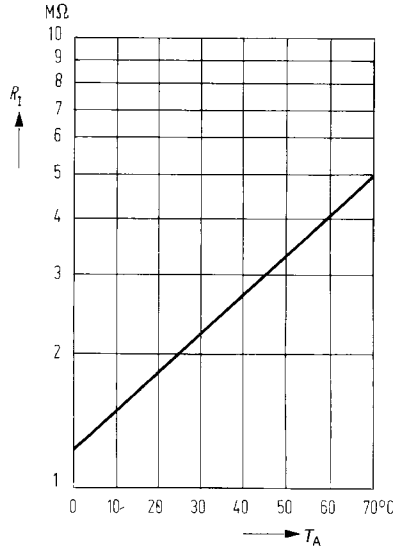

**Input offset current versus supply voltage**

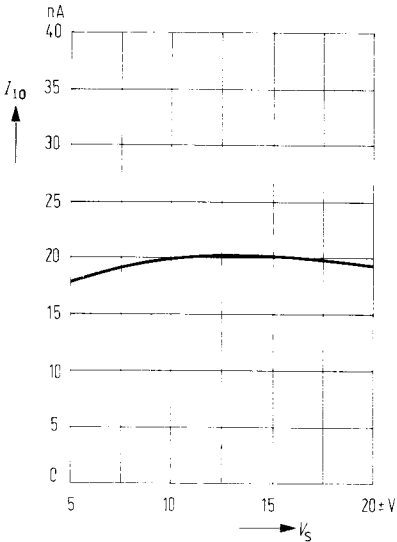

**Input offset current versus ambient temperature**  
 $V_S = \pm 15\text{ V}$

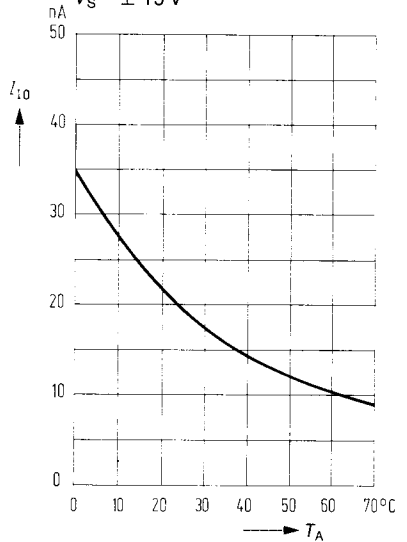

**Output voltage versus load resistance**  
 $V_S = \pm 15\text{ V}$

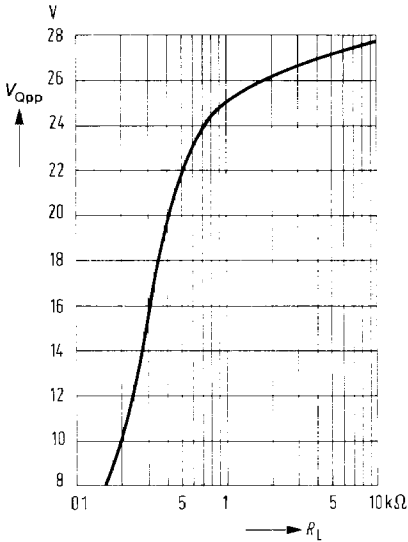

**Phase response of open-loop voltage gain**  
**Phase versus frequency**  
 $V_S = \pm 15\text{ V}$

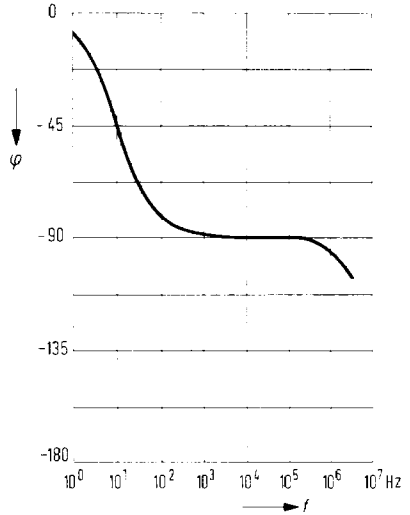

**Output voltage versus frequency**  
 $V_S = \pm 15\text{ V}; R_L = 10\text{ k}\Omega$

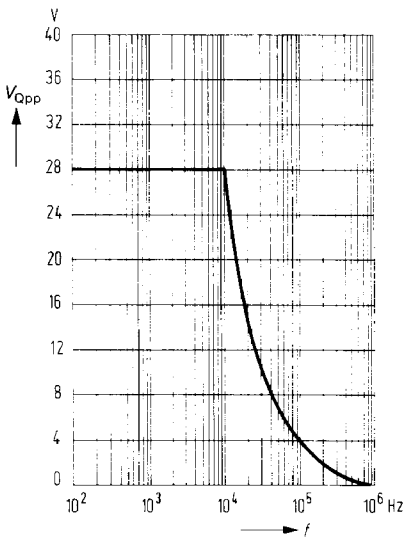

**Input resistance and input capacitance versus frequency**

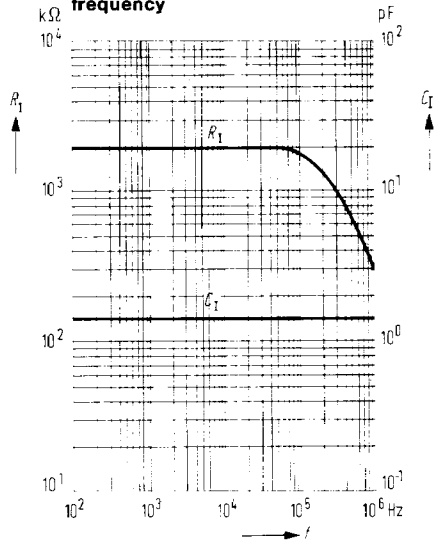



**Output resistance versus frequency**

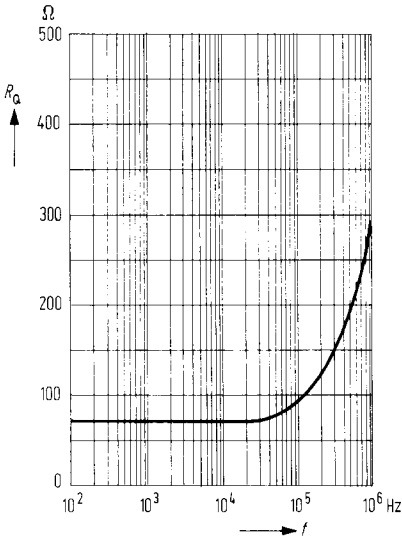

**Open-loop voltage gain versus frequency**

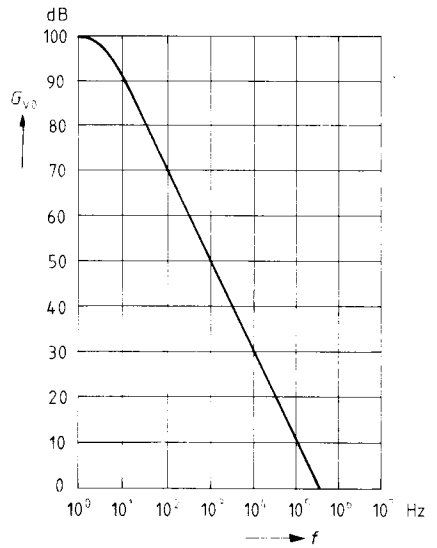

**Supply current versus supply voltage**

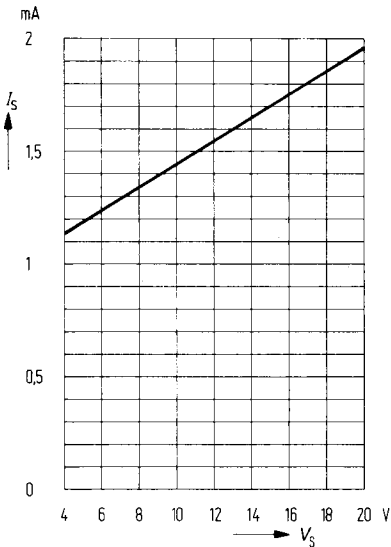

**Offset voltage adjustment circuit**

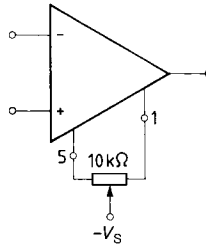

**Transient response**

