

TURN-ON AND TURN-OFF TIME TEST CIRCUIT

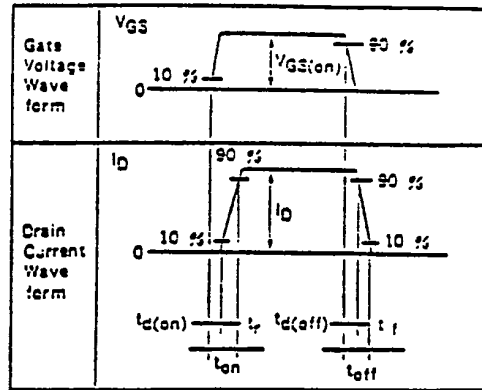

DERATING FACTOR OF FORWARD BIAS SAFE OPERATING AREA

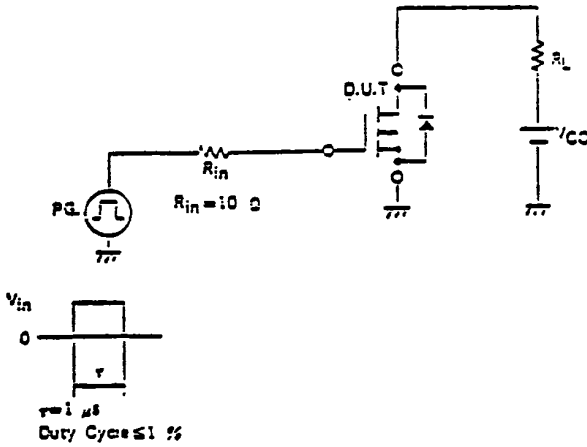
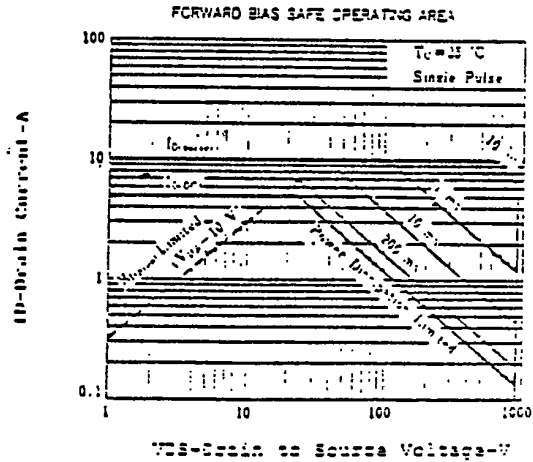
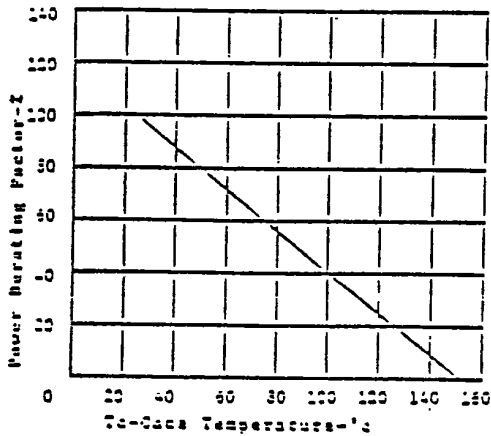

TOTAL POWER DISSIPATION vs. CASE TEMPERATURE

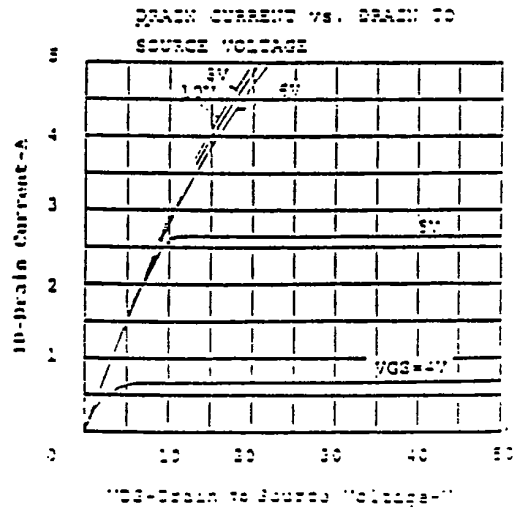
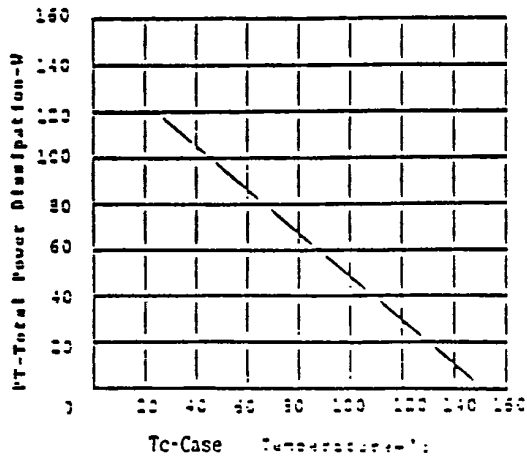

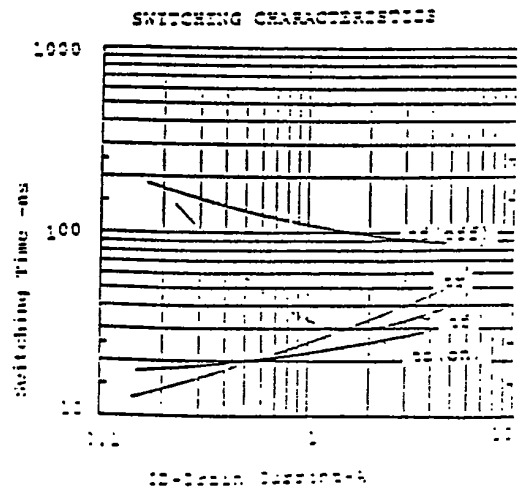
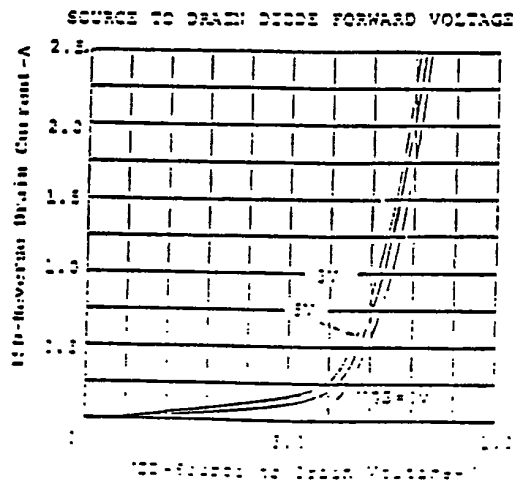
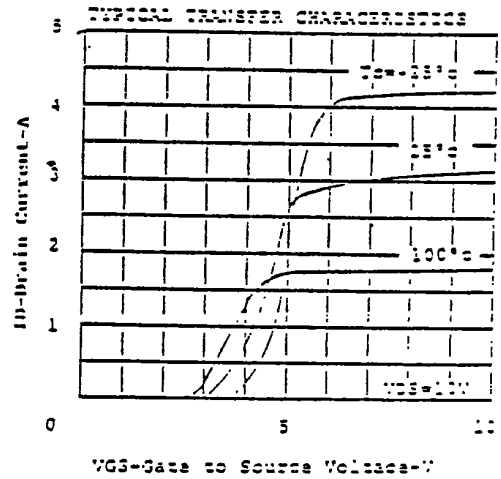
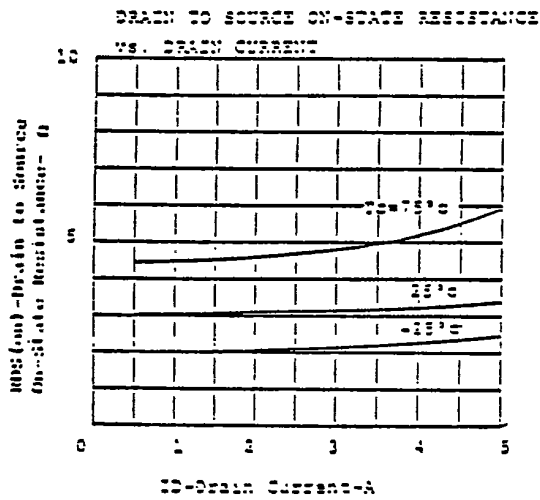
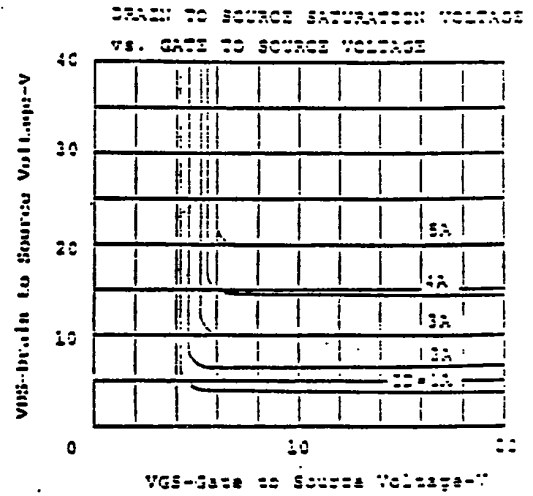
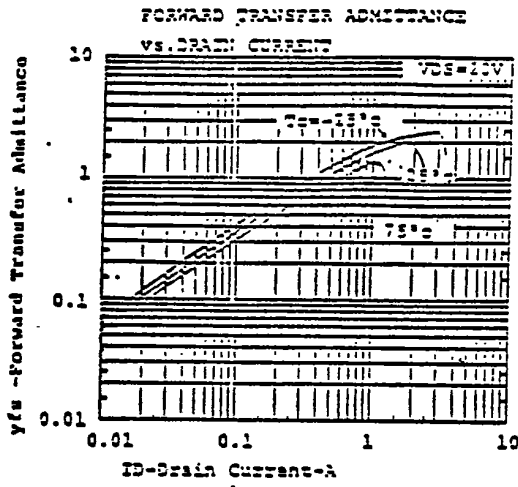

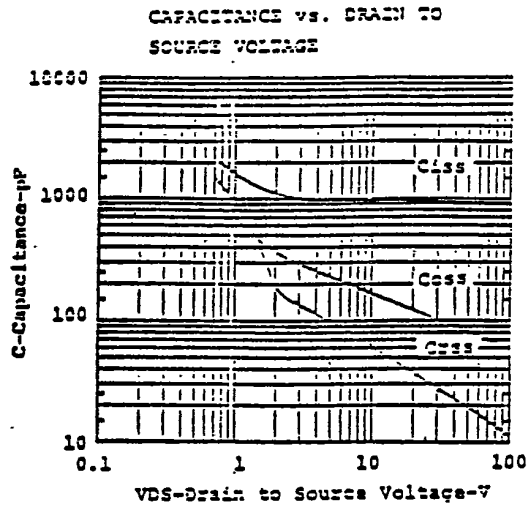

NEC Corporation

INTERNATIONAL ELECTRON DEVICES DIV.
 NEC Building, 33-1, Shiba Guchome
 Minato-ku, Tokyo 103, Japan
 Tel: Tokyo 454-1111
 Telex Address: NECTOK J22886
 Cable Address: MICROPHONE TOKYO