

45 W AF POWER AMPLIFIER

DESCRIPTION

The μ PC2500A is an audio power amplifier in a 12-lead single in-line package, specifically designed for car stereo applications.

Typically it provides output power of 45 W at 14.4 V or 40 W at 13.2 V to a 2 Ω load.

This IC can be used without output capacitors, because its two output terminals have the same potential and it includes original short circuit protection function which protects internal output power transistors and a speaker at the same time when one output terminal is shorted to ground or V_{CC} .

FEATURES

- Internal stand-by switch circuit; CMOS drive possible.
- Can be used as OCL connection.
- Very low output offset voltage : $V_{offset} = 150$ mV (MAX.)
- High output power : $P_O = 45$ W (TYP.) @ $R_L = 2 \Omega$, $V_{CC} = 14.4$ V, THD = 10 %
 $P_O = 40$ W (TYP.) @ $R_L = 2 \Omega$, $V_{CC} = 13.2$ V, THD = 10 %
- Very low distortion : THD = 0.03 % (TYP.) @ $R_L = 2 \Omega$, $V_{CC} = 13.2$ V, $P_O = 8$ W, $f = 1$ kHz
- Following protection circuits are included.
 - (1) Load dump voltage surge protection circuit.
 - (2) Thermal shut down protection circuit.
 - (3) Output terminal short circuit protection circuit. (V_{CC} to OUT, OUT to GND, OUT to OUT)
 - (4) Loudspeaker protection circuit.

ORDERING INFORMATION

PART NUMBER	PACKAGE	QUALITY GRADE
μ PC2500AH	12 PIN PLASTIC POWER SIP (L)	Standard

Please refer to "Quality grade on NEC Semiconductor Devices" (Document number IEI-1209) published by NEC Corporation to know the specification of quality grade on the devices and its recommended applications.

The information in this document is subject to change without notice.

BLOCK DIAGRAM

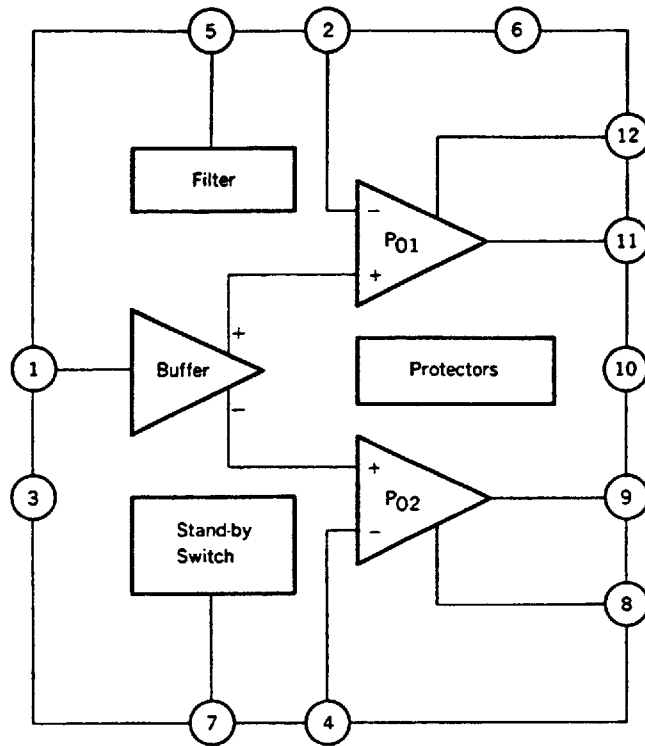

CONNECTION DIAGRAM

PIN NO.	CONNECTION	PIN NO.	CONNECTION
1	Input	7	Stand-by Switch
2	NFB1	8	Bootstrap 2
3	GND for Input	9	Output 2
4	NFB2	10	GND for Output
5	Filter	11	Output 1
6	VCC	12	Bootstrap 1

ABSOLUTE MAXIMUM RATINGS (T_a = 25 °C)

Supply Voltage (Note)	V _{CC surge}	60*	V
Supply Voltage (Operational)	V _{CC}	18	V
Output Current (Instantaneous)	I _o	8	A
Power Dissipation	P _D	50	W
Operating Temperature	T _{opt}	-30 to +85	°C
Storage Temperature	T _{stg}	-40 to +150	°C

*

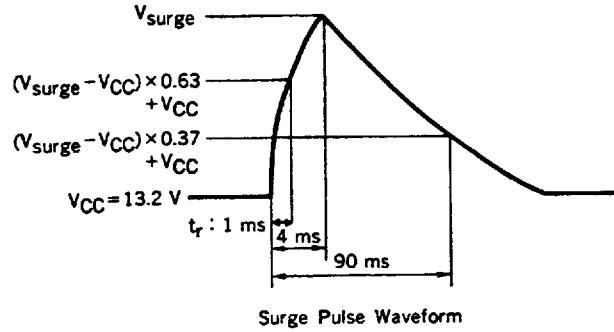

RECOMMENDED OPERATING CONDITIONS (T_a = 25 °C)

Supply Voltage Range	9 to 16	V
Load Impedance	2 to 8	Ω
Pin 7 Voltage (Operating)	3.5 to V _{CC}	V
Pin 7 Voltage (Stand-by)	0 to 1.5	V
Voltage Gain	34 MIN.	dB

ELECTRICAL CHARACTERISTICS (T_a = 25 °C, V_{CC} = 13.2 V, R_L = 4 Ω, f = 1 kHz)

CHARACTERISTIC	SYMBOL	MIN.	TYP.	MAX.	UNIT	TEST CONDITIONS
Quiescent Current	I _{CC}		150	250	mA	V _i = 0
Output Offset Voltage	V _{offset}	-150	0	+150	mV	V _i = 0
Output Power	P _{O1}	32	40		W	R _L = 2 Ω, THD = 10 %
	P _{O2}		45		W	R _L = 2 Ω, THD = 10 %, V _{CC} = 14.4 V
	P _{O3}	20	24		W	R _L = 4 Ω, THD = 10 %
	P _{O4}	25	33		W	R _L = 2 Ω, THD = 1 %
	P _{O5}	15	19		W	R _L = 4 Ω, THD = 1 %
Voltage Gain	A _v		40		dB	P _O = 2 W
Total Harmonic Distortion	THD ₁		0.03	0.12	%	R _L = 2 Ω, P _O = 8 W
	THD ₂		0.03	0.12	%	R _L = 4 Ω, P _O = 4 W
Output Noise Level	V _n		0.35	0.7	mV	R _G = 10 kΩ, BW = 20 Hz to 20 kHz
Supply Voltage Rejection Ratio	SVR	50	60		dB	R _G = 0, f _{rip} = 100 Hz, V _{rip} = 1.0 V
Input Resistance	R _i	20	30		kΩ	
Roll-off Frequency	f _H	100	250	400	kHz	A _v = -3 dB from 1 kHz Ref High
	f _L		5	10	Hz	A _v = -3 dB from 1 kHz Ref Low
Stand-by Current	I _{CC(SB)}		0.05	10	μA	0 ≤ V ₇ ≤ 1.5 V

TEST CIRCUIT

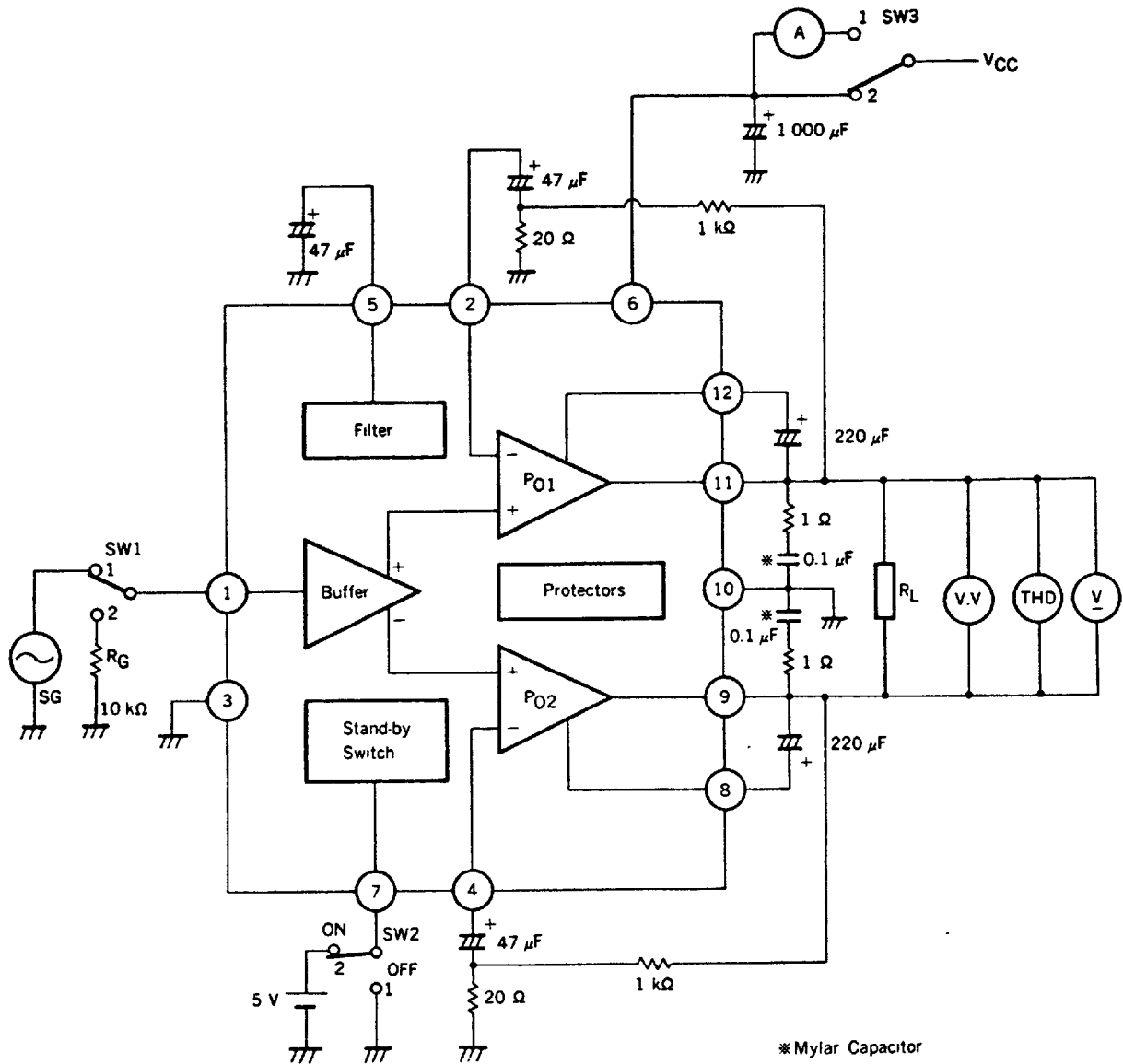

SWITCH POSITION

CHARACTERISTIC	SYMBOL	SW 1	SW 2	SW 3
Quiescent Current	I_{CC}	2	2	1
Output Offset Voltage	V_{offset}	2	2	2
Voltage Gain	A_v	1	2	2
Output Power	P_O	1	2	2
Total Harmonic Distortion	THD	1	2	2
Output Noise Level	V_n	2	2	2
Stand-by Current	$I_{CC(SB)}$	2	1	1

TYPICAL APPLICATION

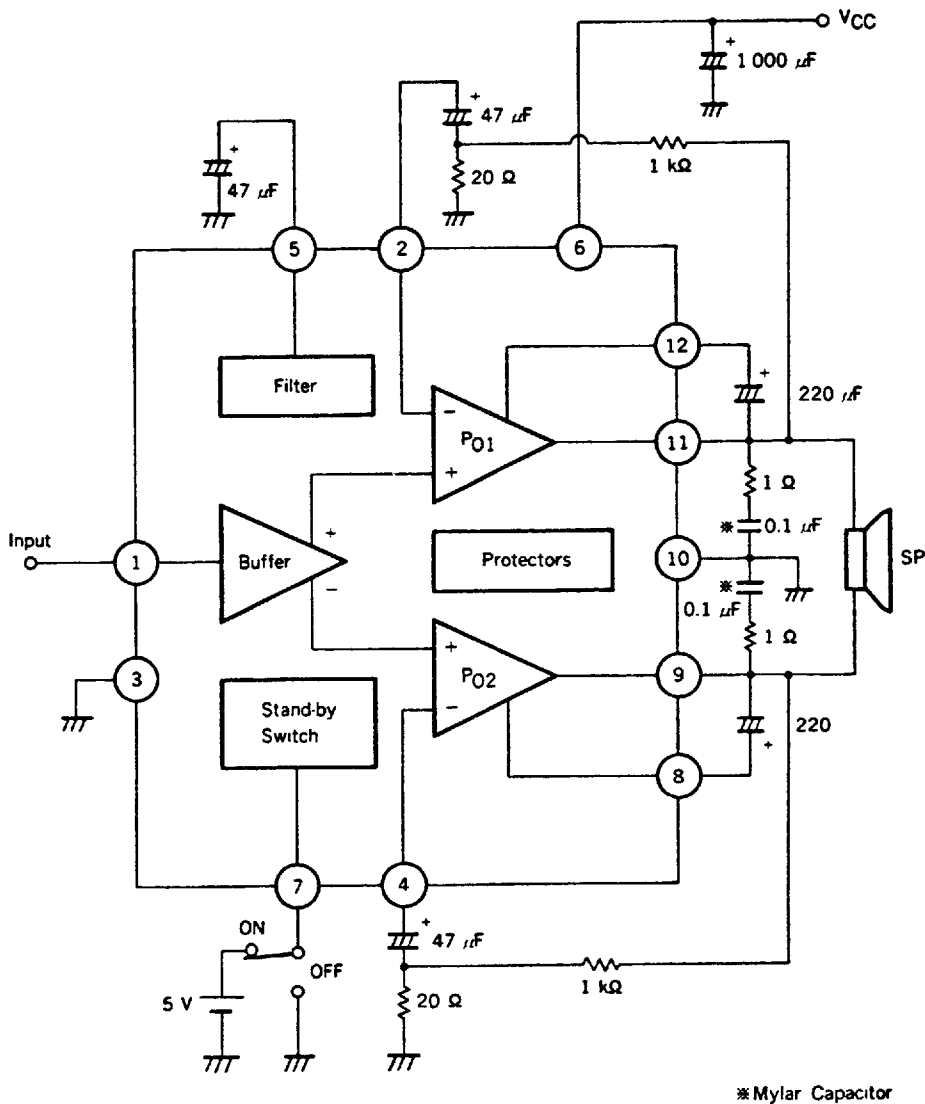

INSTRUCTION FOR USE

- (1) How to attach the heatsink.
 - Surely use the silicon grease.
 - Please keep the fastening torque for the screw in the range of 5 to 8 kg·cm.
 - Flatness of attached area of heatsink should be kept within 0.1 mm.
- (2) When this IC is unstable due to the high impedance of signal source, connect a capacitor (about 1 000 pF) between Pin 1 and Pin 3.

TYPICAL CHARACTERISTICS ($T_a = 25^\circ\text{C}$)

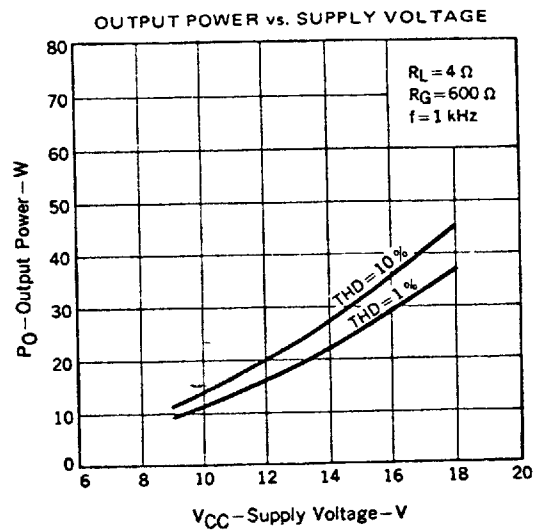
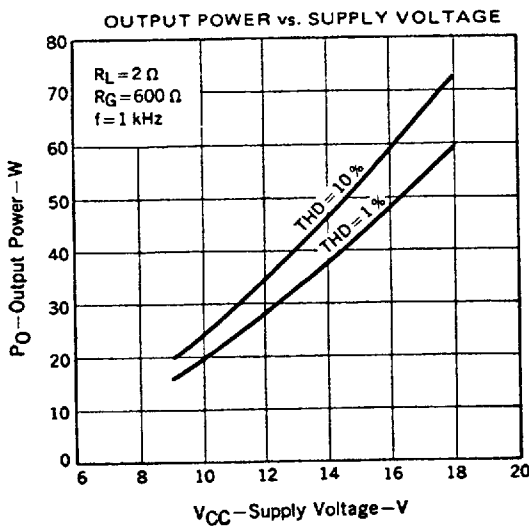
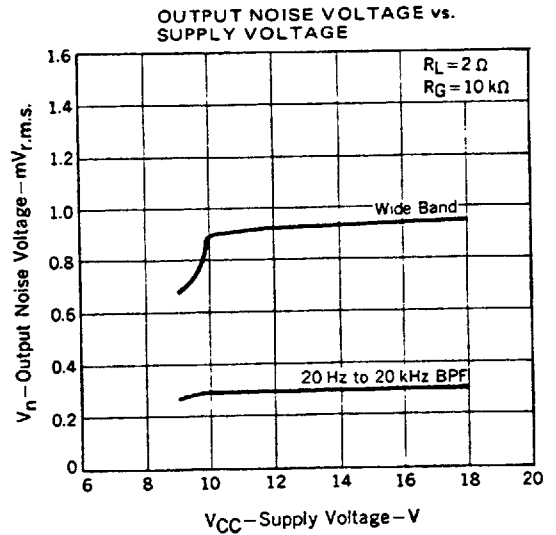
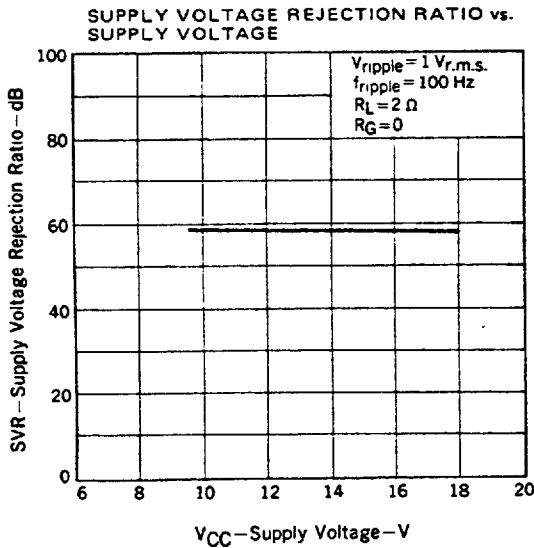
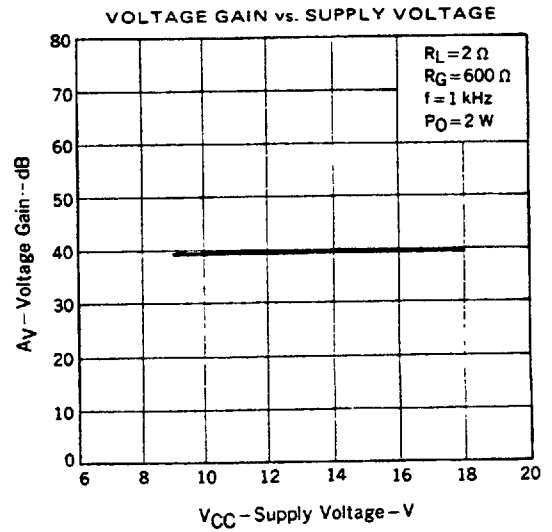
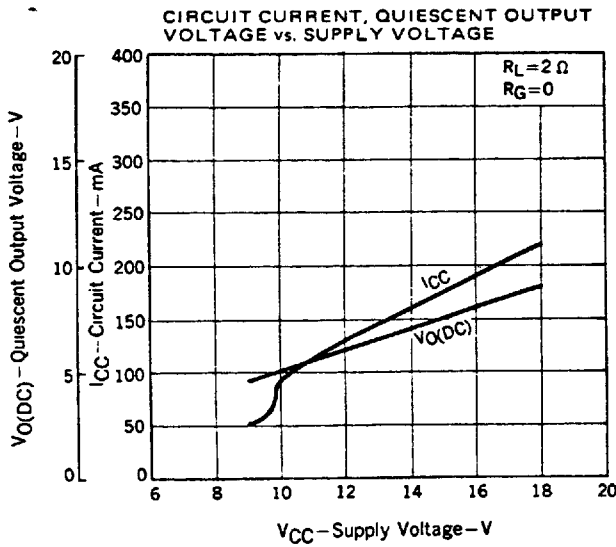

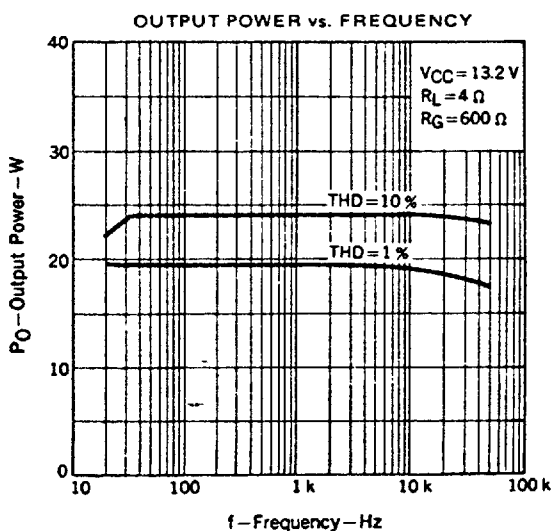
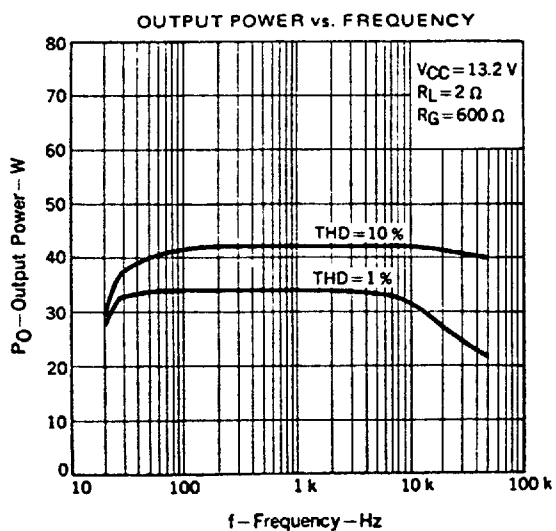
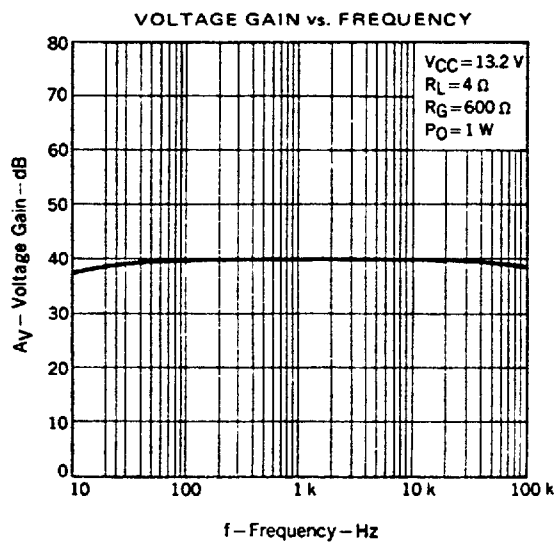
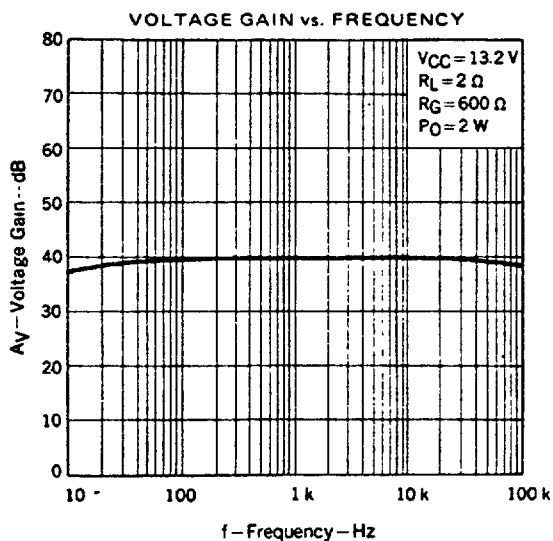
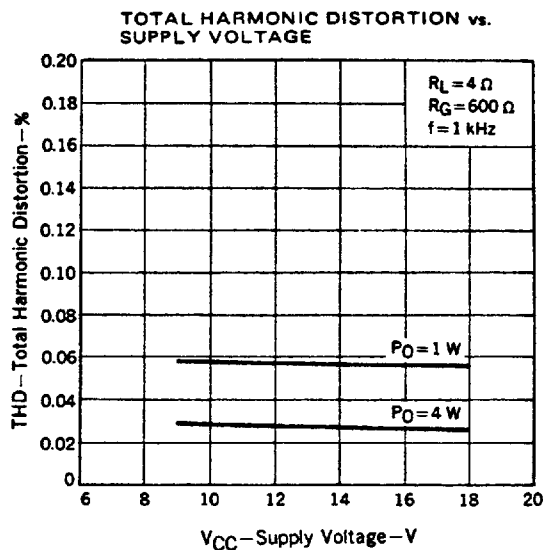
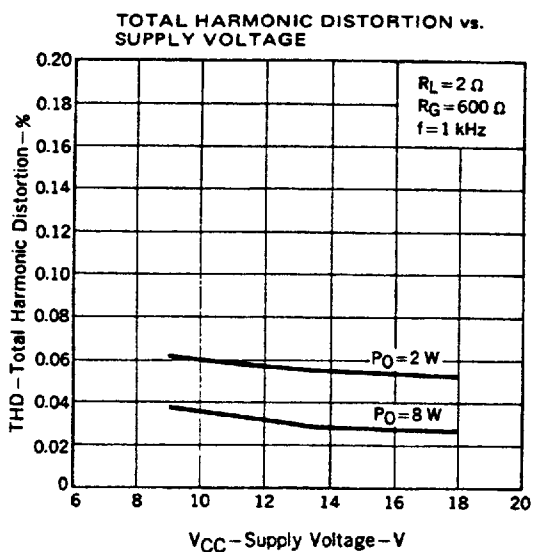

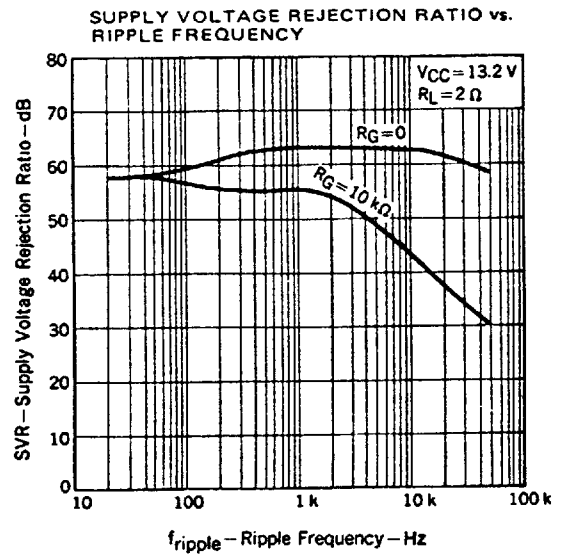
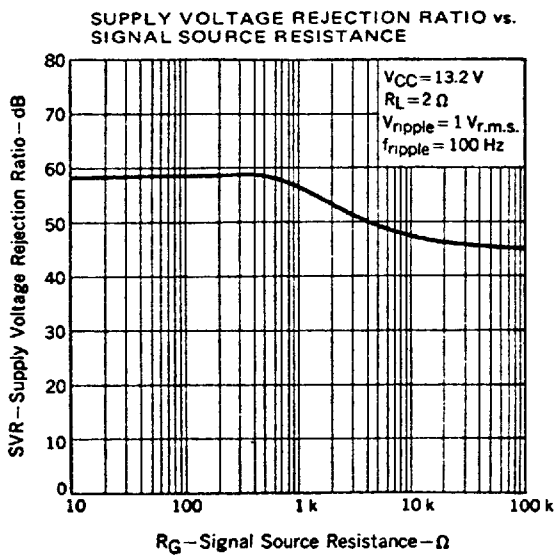
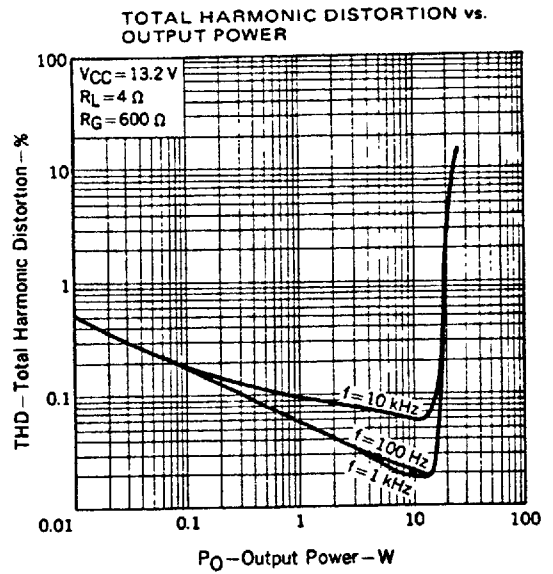
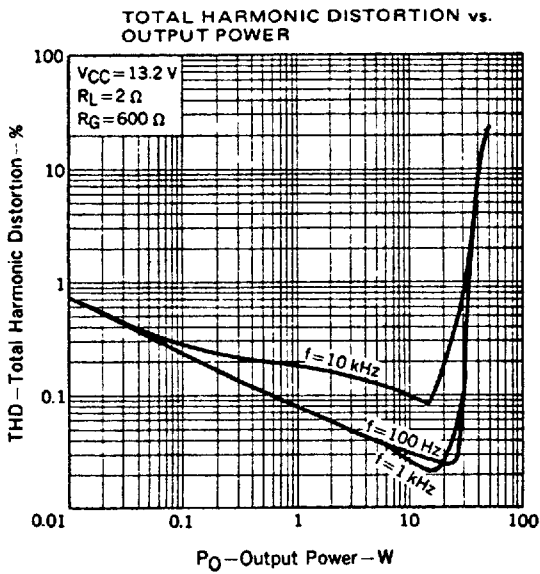
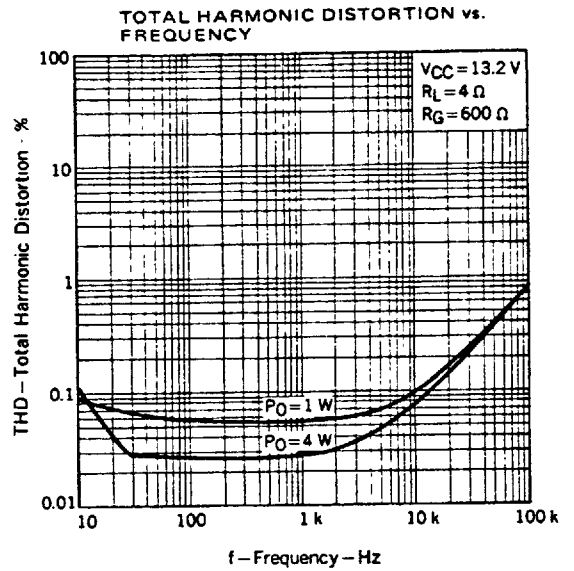
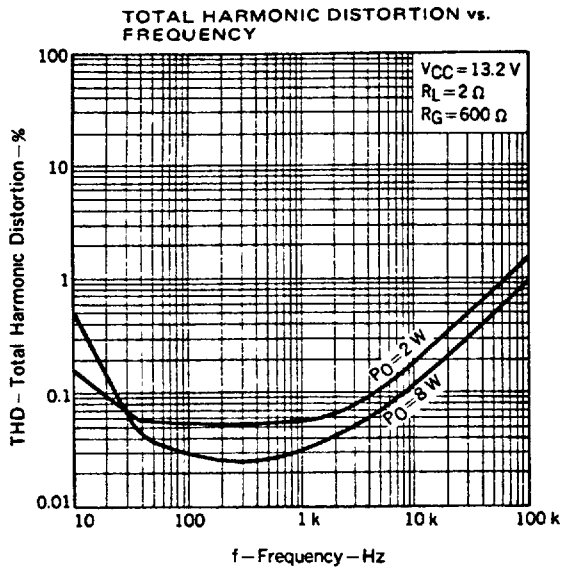

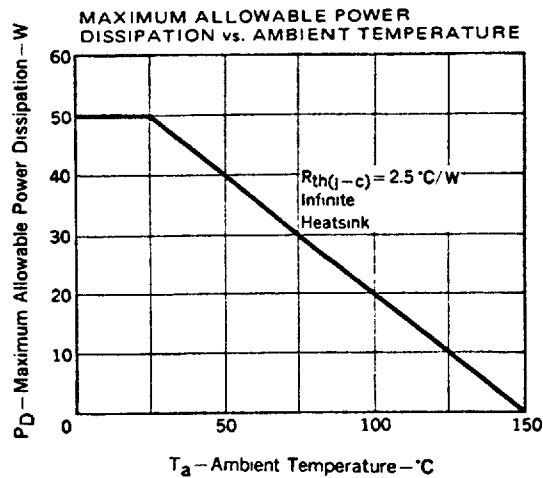
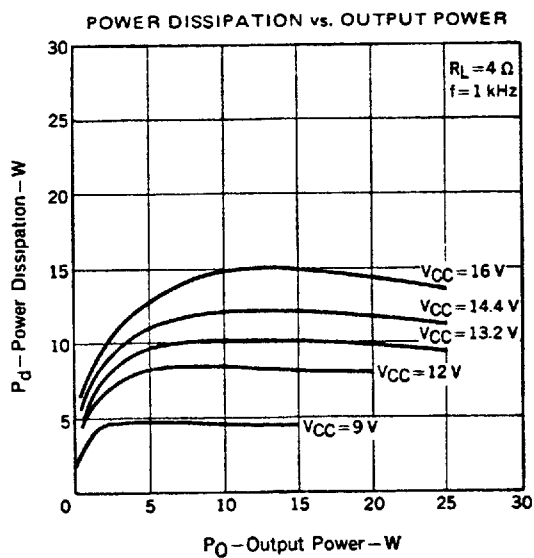
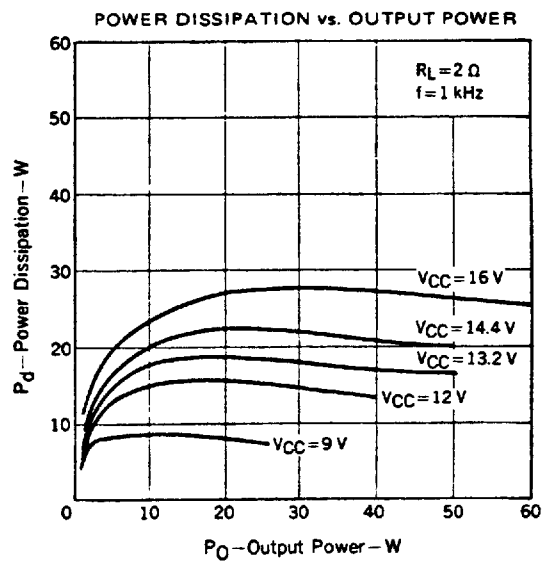
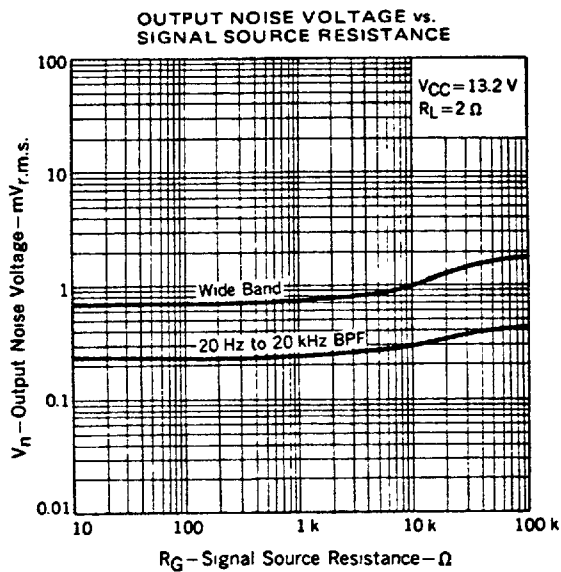

RECOMMENDED SOLDERING CONDITIONS

The following conditions (see table below) must be met when soldering this product.

Please consult with our sales offices in case other soldering process is used, or in case soldering is done under different conditions.

TYPE OF THROUGH HOLE MOUNT DEVICE**μPC2500AH**

Soldering process	Soldering conditions
Wave soldering	Solder temperature: 260 °C or below, Flow time: 10 seconds or below

PACKAGE DIMENSIONS

12 PIN PLASTIC POWER SIP (L)

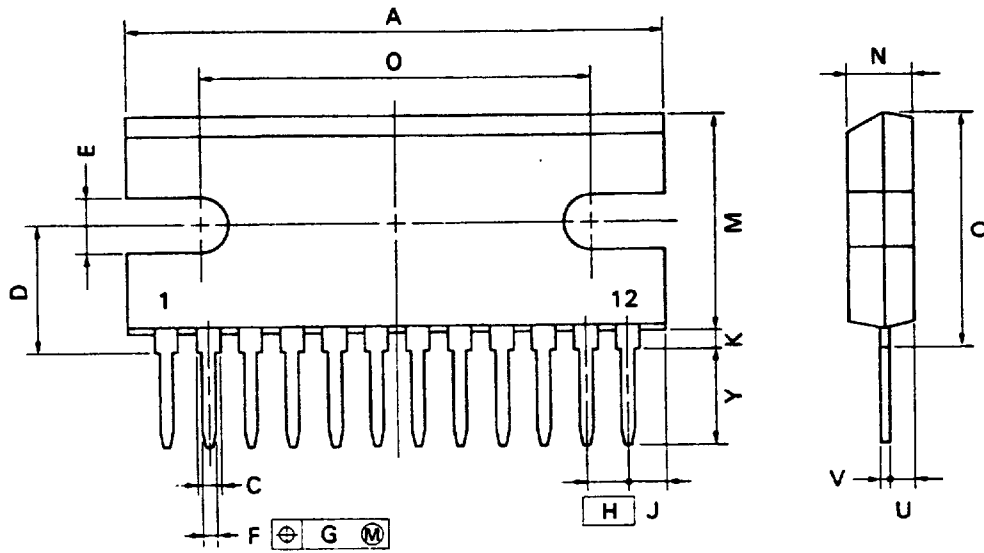

NOTE

Each lead centerline is located within 0.25 mm (0.01 inch) of its true position (T.P.) at maximum material condition.

P12HP-254B2

ITEM	MILLIMETERS	INCHES
A	33.02 MAX.	1.3 MAX.
C	1.2 MIN.	0.047 MIN.
D	8.2 ^{-0.3}	0.323 ^{-0.012}
E	3.6 ^{-0.1}	0.142 ^{-0.004}
F	0.8 ^{-0.1}	0.031 ^{-0.004}
G	0.25	0.01
H	2.54	0.1
J	2.54 MAX.	0.1 MAX.
K	1.0 MIN.	0.039 MIN.
M	13.8 MAX.	0.544 MAX.
N	4.8 ^{-0.2}	0.189 ^{-0.008}
O	24.0 ^{-0.1}	0.945 ^{-0.004}
Q	15.0 MAX.	0.591 MAX.
U	2.8 MAX.	0.111 MAX.
V	0.35 ^{-0.1}	0.014 ^{-0.004}
Y	6.5 ^{-0.7}	0.256 ^{-0.028}