

BIPOLAR ANALOG INTEGRATED CIRCUIT

μ PC2400A Series

THREE TERMINAL LOW DROPOUT VOLTAGE REGULATOR

DESCRIPTION

μ PC2400A Series are low dropout regulators which have 1 A capable for the output current. These ICs are built-in the saturation protection circuit of the output transistor.

FEATURES

- Built-in the saturation protection circuit of the output transistor.
- The capability of output current is 1 A
- High accuracy of output voltage.
 - $|\Delta V_o| \leq \pm 2\%$ ($T_J = 25\text{ }^\circ\text{C}$)
 - $|\Delta V_o| \leq \pm 3\%$ ($0\text{ }^\circ\text{C} \leq T_J \leq 125\text{ }^\circ\text{C}$)
- Low dropout voltage.
 - $V_{DIF} \leq 1\text{ V}$ ($I_o \leq 1\text{ A}$, $T_J \leq 125\text{ }^\circ\text{C}$)
- Built-in overcurrent protection circuit, thermal shut-down circuit.
- Built-in Safe Operating Area protection circuit.
- Compatible for μ PC2400 Series.

CONNECTION DIAGRAM (TOP VIEW)

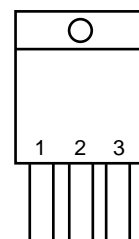

1: INPUT
2: GND
3: OUTPUT

ORDERING INFORMATION

Output Voltage	Type Number	Package
5 V	μ PC2405AHF	MP-45G (Isolated TO-220)
6 V	μ PC2406AHF	
7 V	μ PC2407AHF	
8 V	μ PC2408AHF	
9 V	μ PC2409AHF	
10 V	μ PC2410AHF	
12 V	μ PC2412AHF	
15 V	μ PC2415AHF	
18 V	μ PC2418AHF	

BLOCK DIAGRAM

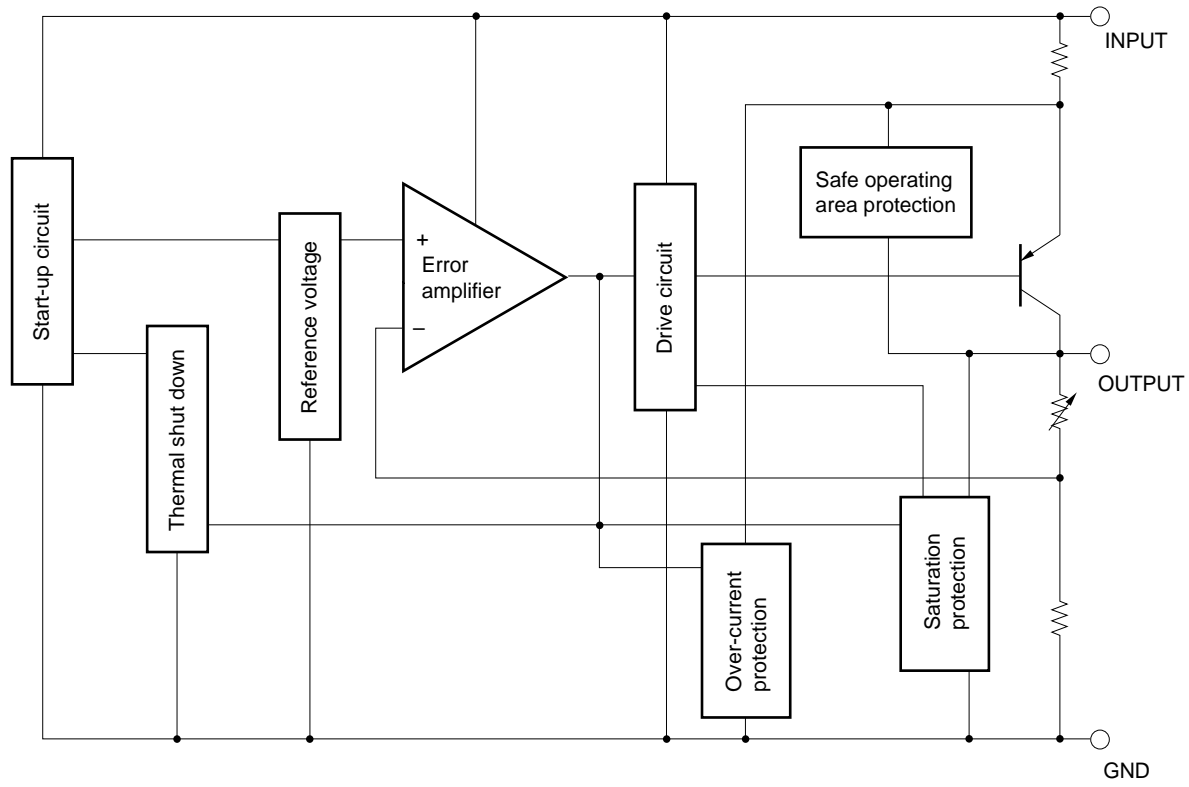

ABSOLUTE MAXIMUM RATINGS (T_A = 25 °C, Unless otherwise specified.)

PARAMETER	SYMBOL	RATING	UNIT
Input Voltage	V _{IN}	36	V
Internal Power Dissipation	P _{T(Tc = 25 °C)}	15 Note	W
Operating Ambient Temperature Range	T _A	-20 to +85	°C
Operating Junction Temperature Range	T _J	-20 to +150	°C
Storage Temperature Range	T _{stg}	-55 to +150	°C
Thermal Resistance (Junction to Case)	R _{th(J - C)}	5.0	°C/W
Thermal Resistance (Junction to Ambient)	R _{th(J - A)}	65	°C/W

Note Internally limited

TYPICAL CONNECTION

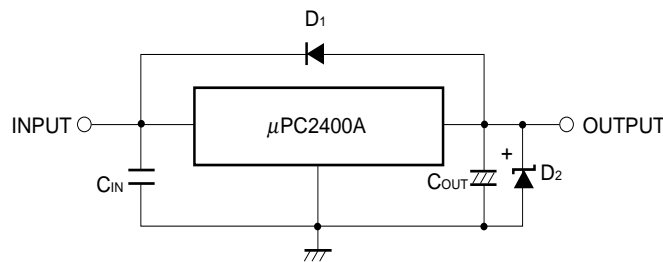

C_{IN} : 0.1 to 0.47 μF.

C_{OUT} : More than 47 μF.

D₁ : Need for V_O > V_{IN}.

D₂ : Need for V_O < GND.

RECOMMENDED OPERATING CONDITIONS

PARAMETER	SYMBOL	TYPE NUMBER	MIN.	TYP.	MAX.	UNIT
Input Voltage	V _{IN}	μPC2405AHF	6	9	20	V
		μPC2406AHF	7	10	21	
		μPC2407AHF	8	11	22	
		μPC2408AHF	9	13	23	
		μPC2409AHF	10	14	24	
		μPC2410AHF	11	15	25	
		μPC2412AHF	13	18	27	
		μPC2415AHF	16	22	27	
μPC2418AHF	19	25	28			
Output Current	I _o	All	0		1	A
Operating Ambient Temperature Range	T _A	All	-20		+85	°C
Operating Junction Temperature Range	T _J	All	-20		+125	°C

ELECTRICAL CHARACTERISTICS

μPC2405A (V_{IN} = 9 V, I_o = 500 mA, T_J = 25 °C, Unless otherwise specified)

PARAMETER	SYMBOL	MIN.	TYP.	MAX.	UNIT	TEST CONDITIONS
Output Voltage	V _o	4.9	5.0	5.1	V	
		4.85		5.15		6 V ≤ V _{IN} ≤ 20 V, 5 mA ≤ I _o ≤ 500 mA, 0 °C ≤ T _J ≤ 125 °C
		4.85		5.15		5 mA ≤ I _o ≤ 1 A, 0 °C ≤ T _J ≤ 125 °C
Line Regulation	REG _{IN}		6	50	mV	6.5 V ≤ V _{IN} ≤ 20 V
Load Regulation	REG _L		3	50	mV	5 mA ≤ I _o ≤ 1 A
Quiescent Current	I _{BIAS}		2.3	3.2	mA	I _o = 0
			9	60		I _o = 1 A
Start-up Current	I _{BIAS(S)}			15	mA	V _{IN} = 4.5 V, I _o = 0 mA
				75		V _{IN} = 4.5 V, I _o = 1 A
Quiescent Current Change	ΔI _{BIAS}			20	mA	6.5 V ≤ V _{IN} ≤ 20 V, I _o = 1 A
Output Noise Voltage	V _n		90		μV _{rms}	10 Hz ≤ f ≤ 100 kHz
Ripple Rejection	R·R	59	64		dB	f = 120 Hz, 6.5 V ≤ V _{IN} ≤ 16.5 V
Dropout Voltage	V _{DIF}		0.5	1.0	V	I _o = 1 A, 0 °C ≤ T _J ≤ 125 °C
Short Circuit Current	I _{short}		1.2		A	V _{IN} = 20 V
Peak Output Current	I _{opeak}	1.65	2.2	3.1	A	
Temperature Coefficient of Output Voltage	ΔV _o /ΔT		-0.4		mV/°C	I _o = 5 mA, 0 °C ≤ T _J ≤ 125 °C

μPC2406A (V_{IN} = 10 V, I_o = 500 mA, T_J = 25 °C, Unless otherwise specified)

PARAMETER	SYMBOL	MIN.	TYP.	MAX.	UNIT	TEST CONDITIONS
Output Voltage	V _o	5.88	6.0	6.12	V	
		5.82		6.18		7 V ≤ V _{IN} ≤ 21 V, 5 mA ≤ I _o ≤ 500 mA, 0 °C ≤ T _J ≤ 125 °C
		5.82		6.18		5 mA ≤ I _o ≤ 1 A, 0 °C ≤ T _J ≤ 125 °C
Line Regulation	REG _{IN}		7	60	mV	7.5 V ≤ V _{IN} ≤ 21 V
Load Regulation	REG _L		4	60	mV	5 mA ≤ I _o ≤ 1A
Quiescent Current	I _{BIAS}		2.3	3.2	mA	I _o = 0
			9	60		I _o = 1 A
Start-up Current	I _{BIAS(S)}			15	mA	V _{IN} = 5.5 V, I _o = 0 mA
				75		V _{IN} = 5.5 V, I _o = 1 A
Quiescent Current Change	ΔI _{BIAS}			20	mA	7.5 V ≤ V _{IN} ≤ 21 V, I _o = 1 A
Output Noise Voltage	V _n		110		μV _{rms}	10 Hz ≤ f ≤ 100 kHz
Ripple Rejection	R·R	58	63		dB	f = 120 Hz, 7.5 V ≤ V _{IN} ≤ 17.5 V
Dropout Voltage	V _{DIF}		0.5	1.0	V	I _o = 1 A, 0 °C ≤ T _J ≤ 125 °C
Short Circuit Current	I _{short}		1.2		A	V _{IN} = 21 V
Peak Output Current	I _{opeak}	1.65	2.2	3.1	A	
Temperature Coefficient of Output Voltage	ΔV _o /ΔT		0.4		mV/°C	I _o = 5 mA, 0 °C ≤ T _J ≤ 125 °C

μPC2407A (V_{IN} = 11 V, I_o = 500 mA, T_J = 25 °C, Unless otherwise specified)

PARAMETER	SYMBOL	MIN.	TYP.	MAX.	UNIT	TEST CONDITIONS
Output Voltage	V _O	6.86	7.0	7.14	V	
		6.79		7.21		8 V ≤ V _{IN} ≤ 22 V, 5 mA ≤ I _o ≤ 500 mA, 0 °C ≤ T _J ≤ 125 °C
		6.79		7.21		5 mA ≤ I _o ≤ 1 A, 0 °C ≤ T _J ≤ 125 °C
Line Regulation	REG _{IN}		8	70	mV	8.5 V ≤ V _{IN} ≤ 22 V
Load Regulation	REG _L		4	70	mV	5 mA ≤ I _o ≤ 1 A
Quiescent Current	I _{BIAS}		2.3	3.2	mA	I _o = 0
			9	60		I _o = 1 A
Start-up Current	I _{BIAS(S)}			15	mA	V _{IN} = 6.5 V, I _o = 0 mA
				75		V _{IN} = 6.5 V, I _o = 1 A
Quiescent Current Change	ΔI _{BIAS}			20	mA	8.5 V ≤ V _{IN} ≤ 22 V, I _o = 1 A
Output Noise Voltage	V _n		130		μV _{rms}	10 Hz ≤ f ≤ 100 kHz
Ripple Rejection	R·R	57	62		dB	f = 120 Hz, 8.5 V ≤ V _{IN} ≤ 18.5 V
Dropout Voltage	V _{DIF}		0.5	1.0	V	I _o = 1 A, 0 °C ≤ T _J ≤ 125 °C
Short Circuit Current	I _{short}		1.2		A	V _{IN} = 22 V
Peak Output Current	I _{peak}	1.65	2.2	3.1	A	
Temperature Coefficient of Output Voltage	ΔV _O /ΔT		0.4		mV/°C	I _o = 5 mA, 0 °C ≤ T _J ≤ 125 °C

μPC2408A (V_{IN} = 13 V, I_o = 500 mA, T_J = 25 °C, Unless otherwise specified)

PARAMETER	SYMBOL	MIN.	TYP.	MAX.	UNIT	TEST CONDITIONS
Output Voltage	V _O	7.85	8.0	8.15	V	
		7.75		8.25		9 V ≤ V _{IN} ≤ 23 V, 5 mA ≤ I _o ≤ 500 mA, 0 °C ≤ T _J ≤ 125 °C
		7.75		8.25		5 mA ≤ I _o ≤ 1 A, 0 °C ≤ T _J ≤ 125 °C
Line Regulation	REG _{IN}		9	80	mV	9.5 V ≤ V _{IN} ≤ 23 V
Load Regulation	REG _L		5	80	mV	5 mA ≤ I _o ≤ 1 A
Quiescent Current	I _{BIAS}		2.3	3.2	mA	I _o = 0
			9	60		I _o = 1 A
Start-up Current	I _{BIAS(S)}			15	mA	V _{IN} = 7.5 V, I _o = 0 mA
				75		V _{IN} = 7.5 V, I _o = 1 A
Quiescent Current Change	ΔI _{BIAS}			20	mA	9.5 V ≤ V _{IN} ≤ 23 V, I _o = 1 A
Output Noise Voltage	V _n		150		μV _{rms}	10 Hz ≤ f ≤ 100 kHz
Ripple Rejection	R·R	56	61		dB	f = 120 Hz, 9.5 V ≤ V _{IN} ≤ 19.5 V
Dropout Voltage	V _{DIF}		0.5	1.0	V	I _o = 1 A, 0 °C ≤ T _J ≤ 125 °C
Short Circuit Current	I _{short}		1.2		A	V _{IN} = 23 V
Peak Output Current	I _{peak}	1.6	2.2	3.05	A	
Temperature Coefficient of Output Voltage	ΔV _O /ΔT		0.5		mV/°C	I _o = 5 mA, 0 °C ≤ T _J ≤ 125 °C

μPC2409A (V_{IN} = 14 V, I_o = 500 mA, T_J = 25 °C, Unless otherwise specified)

PARAMETER	SYMBOL	MIN.	TYP.	MAX.	UNIT	TEST CONDITIONS
Output Voltage	V _O	8.82	9.0	9.18	V	
		8.73		9.27		10 V ≤ V _{IN} ≤ 24 V, 5 mA ≤ I _o ≤ 500 mA, 0 °C ≤ T _J ≤ 125 °C
		8.73		9.27		5 mA ≤ I _o ≤ 1 A, 0 °C ≤ T _J ≤ 125 °C
Line Regulation	REG _{IN}		11	90	mV	10.5 V ≤ V _{IN} ≤ 24 V
Load Regulation	REG _L		5	90	mV	5 mA ≤ I _o ≤ 1 A
Quiescent Current	I _{BIAS}		2.4	3.2	mA	I _o = 0
			9	60		I _o = 1 A
Start-up Current	I _{BIAS(S)}			15	mA	V _{IN} = 8.5 V, I _o = 0 mA
				75		V _{IN} = 8.5 V, I _o = 1 A
Quiescent Current Change	ΔI _{BIAS}			20	mA	10.5 V ≤ V _{IN} ≤ 24 V, I _o = 1 A
Output Noise Voltage	V _n		170		μV _{rms}	10 Hz ≤ f ≤ 100 kHz
Ripple Rejection	R·R	55	60		dB	f = 120 Hz, 10.5 V ≤ V _{IN} ≤ 20.5 V
Dropout Voltage	V _{DIF}		0.5	1.0	V	I _o = 1 A, 0 °C ≤ T _J ≤ 125 °C
Short Circuit Current	I _{Oshort}		1.0		A	V _{IN} = 24 V
Peak Output Current	I _{Opeak}	1.6	2.2	3.05	A	
Temperature Coefficient of Output Voltage	ΔV _O /ΔT		0.9		mV/°C	I _o = 5 mA, 0 °C ≤ T _J ≤ 125 °C

μPC2410A (V_{IN} = 15 V, I_o = 500 mA, T_J = 25 °C, Unless otherwise specified)

PARAMETER	SYMBOL	MIN.	TYP.	MAX.	UNIT	TEST CONDITIONS
Output Voltage	V _O	9.8	10	10.2	V	
		9.7		10.3		11 V ≤ V _{IN} ≤ 25 V, 5 mA ≤ I _o ≤ 500 mA, 0 °C ≤ T _J ≤ 125 °C
		9.7		10.3		5 mA ≤ I _o ≤ 1 A, 0 °C ≤ T _J ≤ 125 °C
Line Regulation	REG _{IN}		12	100	mV	11.5 V ≤ V _{IN} ≤ 25 V
Load Regulation	REG _L		6	100	mV	5 mA ≤ I _o ≤ 1A
Quiescent Current	I _{BIAS}		2.4	3.2	mA	I _o = 0
			9	60		I _o = 1 A
Start-up Current	I _{BIAS(S)}			15	mA	V _{IN} = 9.5 V, I _o = 0 mA
				75		V _{IN} = 9.5 V, I _o = 1 A
Quiescent Current Change	ΔI _{BIAS}			20	mA	11.5 V ≤ V _{IN} ≤ 25 V, I _o = 1 A
Output Noise Voltage	V _n		190		μV _{rms}	10 Hz ≤ f ≤ 100 kHz
Ripple Rejection	R·R	54	59		dB	f = 120 Hz, 11.5 V ≤ V _{IN} ≤ 21.5 V
Dropout Voltage	V _{DIF}		0.5	1.0	V	I _o = 1 A, 0 °C ≤ T _J ≤ 125 °C
Short Circuit Current	I _{Oshort}		1.0		A	V _{IN} = 25 V
Peak Output Current	I _{Opeak}	1.6	2.2	3.05	A	
Temperature Coefficient of Output Voltage	ΔV _O /ΔT		0.8		mV/°C	I _o = 5 mA, 0 °C ≤ T _J ≤ 125 °C

μPC2412A (V_{IN} = 18 V, I_o = 500 mA, T_J = 25 °C, Unless otherwise specified)

PARAMETER	SYMBOL	MIN.	TYP.	MAX.	UNIT	TEST CONDITIONS
Output Voltage	V _O	11.75	12	12.25	V	
		11.65		12.35		13 V ≤ V _{IN} ≤ 27 V, 5 mA ≤ I _o ≤ 500 mA, 0 °C ≤ T _J ≤ 125 °C
		11.65		12.35		5 mA ≤ I _o ≤ 1 A, 0 °C ≤ T _J ≤ 125 °C
Line Regulation	REG _{IN}		14	120	mV	14 V ≤ V _{IN} ≤ 27 V
Load Regulation	REG _L		7	120	mV	5 mA ≤ I _o ≤ 1 A
Quiescent Current	I _{BIAS}		2.4	3.2	mA	I _o = 0
			10	60		I _o = 1 A
Start-up Current	I _{BIAS(S)}			15	mA	V _{IN} = 11.5 V, I _o = 0 mA
				75		V _{IN} = 11.5 V, I _o = 1 A
Quiescent Current Change	ΔI _{BIAS}			20	mA	14 V ≤ V _{IN} ≤ 27 V, I _o = 1 A
Output Noise Voltage	V _n		230		μV _{rms}	10 Hz ≤ f ≤ 100 kHz
Ripple Rejection	R·R	53	58		dB	f = 120 Hz, 14 V ≤ V _{IN} ≤ 24 V
Dropout Voltage	V _{DIF}		0.5	1.0	V	I _o = 1 A, 0 °C ≤ T _J ≤ 125 °C
Short Circuit Current	I _{short}		0.8		A	V _{IN} = 27 V
Peak Output Current	I _{opeak}	1.58	2.2	3.03	A	
Temperature Coefficient of Output Voltage	ΔV _O /ΔT		0.8		mV/°C	I _o = 5 mA, 0 °C ≤ T _J ≤ 125 °C

μPC2415A (V_{IN} = 22 V, I_o = 500 mA, T_J = 25 °C, Unless otherwise specified)

PARAMETER	SYMBOL	MIN.	TYP.	MAX.	UNIT	TEST CONDITIONS
Output Voltage	V _O	14.7	15	15.3	V	
		14.55		15.45		16 V ≤ V _{IN} ≤ 27 V, 5 mA ≤ I _o ≤ 500 mA, 0 °C ≤ T _J ≤ 125 °C
		14.55		15.45		5 mA ≤ I _o ≤ 1 A, 0 °C ≤ T _J ≤ 125 °C
Line Regulation	REG _{IN}		18	150	mV	17 V ≤ V _{IN} ≤ 27 V
Load Regulation	REG _L		9	150	mV	5 mA ≤ I _o ≤ 1A
Quiescent Current	I _{BIAS}		2.5	3.2	mA	I _o = 0
			10	60		I _o = 1 A
Start-up Current	I _{BIAS(S)}			15	mA	V _{IN} = 14.5 V, I _o = 0 mA
				75		V _{IN} = 14.5 V, I _o = 1 A
Quiescent Current Change	ΔI _{BIAS}			20	mA	17 V ≤ V _{IN} ≤ 27 V, I _o = 1 A
Output Noise Voltage	V _n		290		μV _{rms}	10 Hz ≤ f ≤ 100 kHz
Ripple Rejection	R·R	51	56		dB	f = 120 Hz, 17 V ≤ V _{IN} ≤ 27 V
Dropout Voltage	V _{DIF}		0.5	1.0	V	I _o = 1 A, 0 °C ≤ T _J ≤ 125 °C
Short Circuit Current	I _{short}		0.8		A	V _{IN} = 27 V
Peak Output Current	I _{opeak}	1.55	2.2	3.0	A	
Temperature Coefficient of Output Voltage	ΔV _O /ΔT		1.6		mV/°C	I _o = 5 mA, 0 °C ≤ T _J ≤ 125 °C

μPC2418A (V_{IN} = 25 V, I_o = 500 mA, T_J = 25 °C, Unless otherwise specified)

PARAMETER	SYMBOL	MIN.	TYP.	MAX.	UNIT	TEST CONDITIONS
Output Voltage	V _o	17.64	18	18.36	V	
		17.46		18.54		19 V ≤ V _{IN} ≤ 28 V, 5 mA ≤ I _o ≤ 500 mA, 0 °C ≤ T _J ≤ 125 °C
		17.46		18.54		5 mA ≤ I _o ≤ 1 A, 0 °C ≤ T _J ≤ 125 °C
Line Regulation	REG _{IN}		22	180	mV	20 V ≤ V _{IN} ≤ 28 V
Load Regulation	REG _L		11	180	mV	5 mA ≤ I _o ≤ 1 A
Quiescent Current	I _{BIAS}		2.5	3.2	mA	I _o = 0
			10	60		I _o = 1 A
Start-up Current	I _{BIAS(S)}			15	mA	V _{IN} = 17.5 V, I _o = 0 mA
				75		V _{IN} = 17.5 V, I _o = 1 A
Quiescent Current Change	ΔI _{BIAS}			20	mA	20 V ≤ V _{IN} ≤ 28 V, I _o = 1 A
Output Noise Voltage	V _n		350		μV _{rms}	10 Hz ≤ f ≤ 100 kHz
Ripple Rejection	R·R	49	54		dB	f = 120 Hz, 20 V ≤ V _{IN} ≤ 28 V
Dropout Voltage	V _{DIF}		0.5	1.0	V	I _o = 1 A, 0 °C ≤ T _J ≤ 125 °C
Short Circuit Current	I _{Oshort}		0.8		A	V _{IN} = 28 V
Peak Output Current	I _{Opeak}	1.55	2.2	3.0	A	
Temperature Coefficient of Output Voltage	ΔV _o /ΔT		2.5		mV/°C	I _o = 5 mA, 0 °C ≤ T _J ≤ 125 °C

TYPICAL CHARACTERISTICS

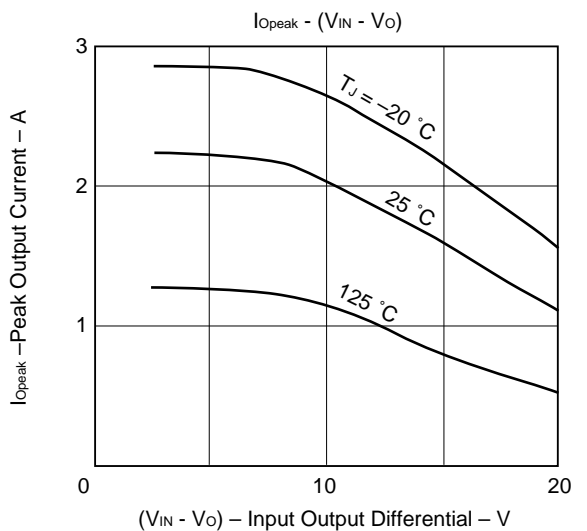
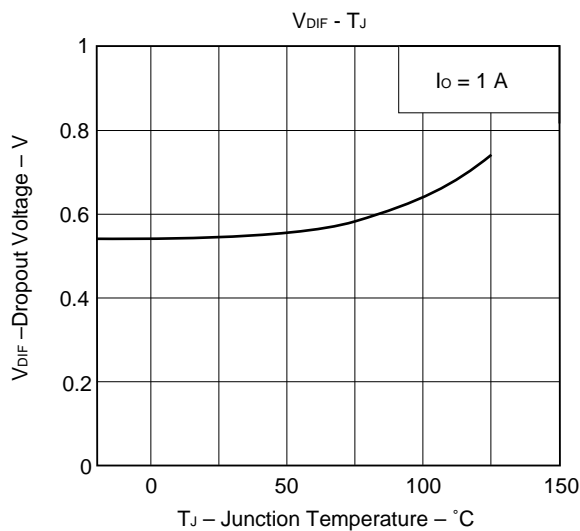
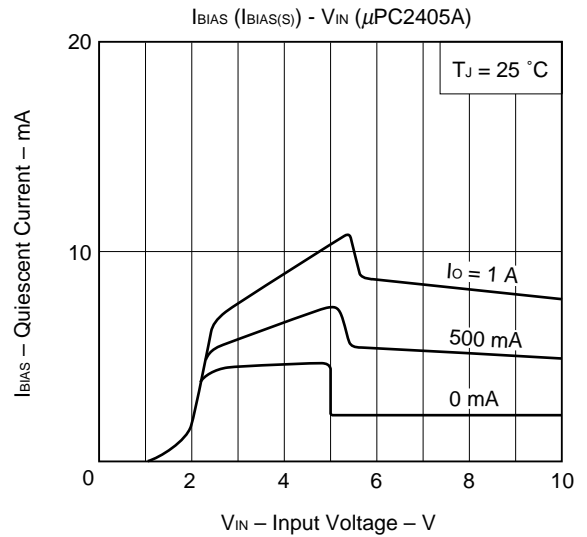
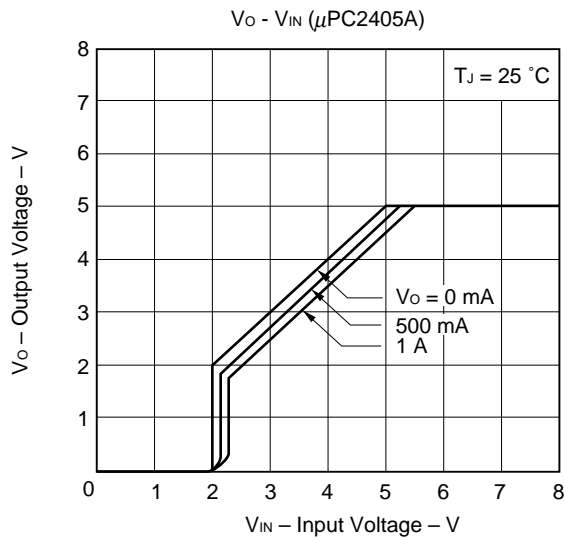
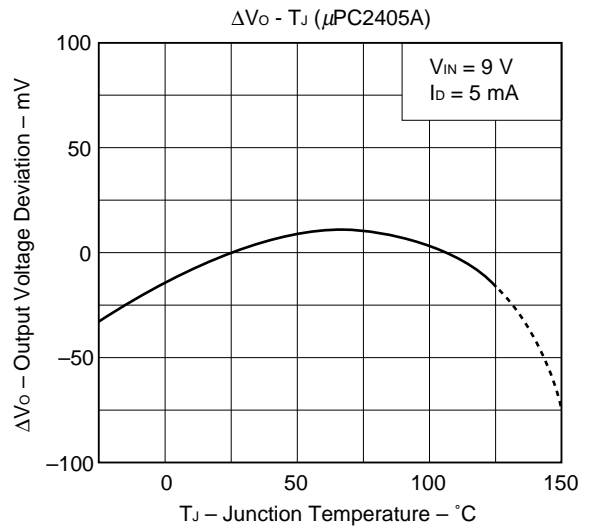
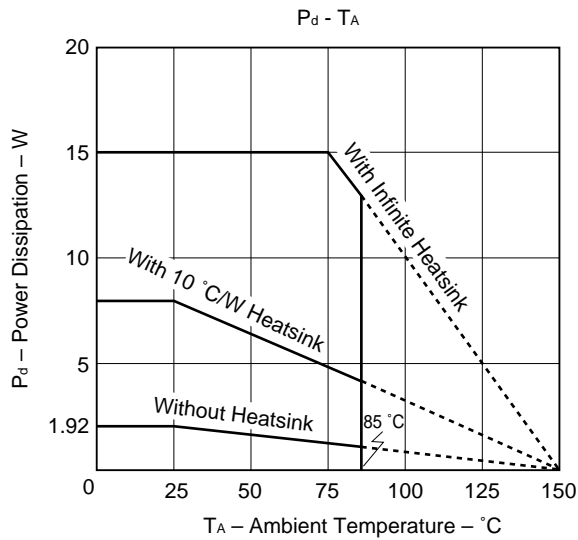

TYPICAL CHARACTERISTICS

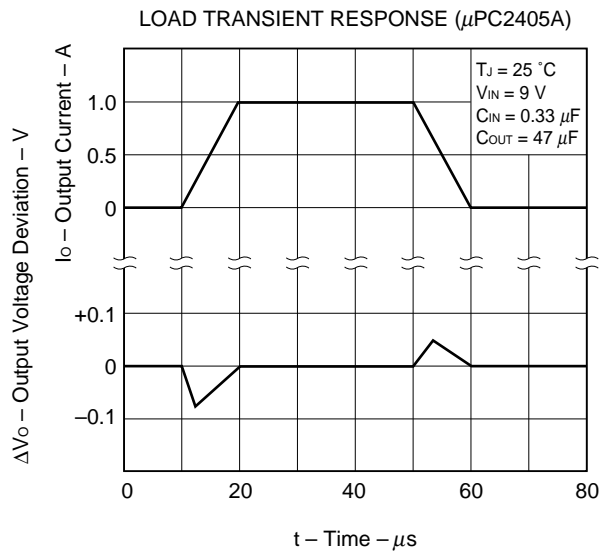
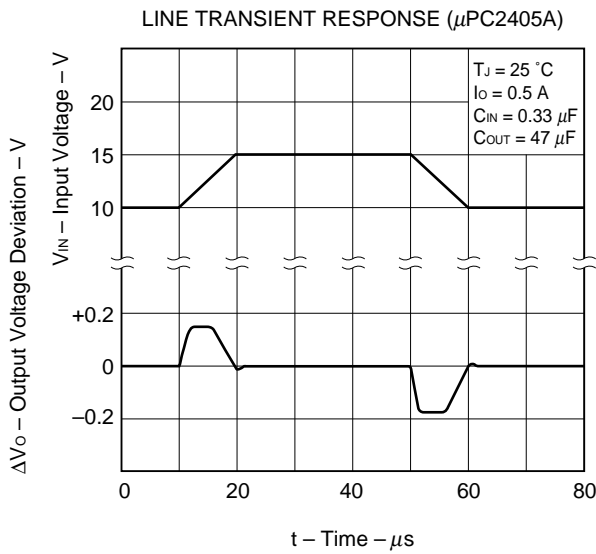
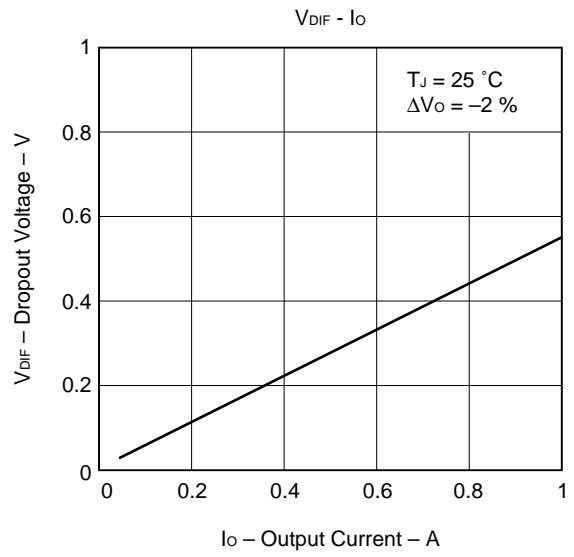
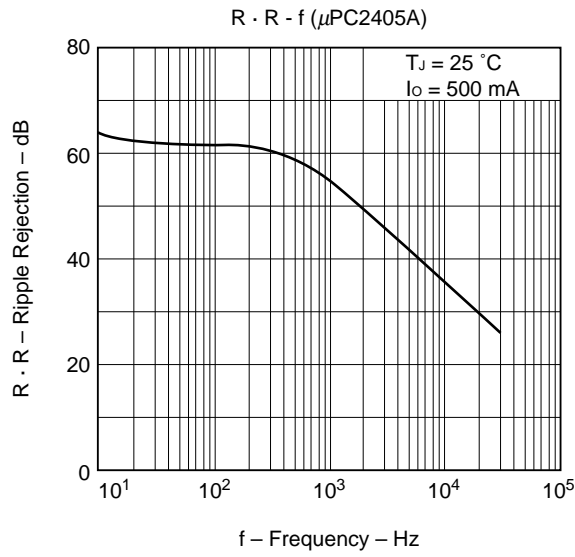

PACKAGE DIMENSIONS (Unit: mm)

μPC2400AHF Series

3PIN PLASTIC SIP (MP-45G)

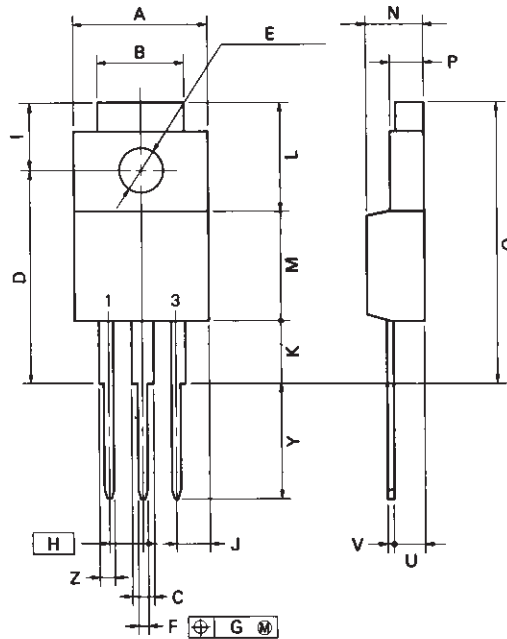

P3HF-254B-1

NOTE

Each lead centerline is located within 0.25 mm (0.01 inch) of its true position (T.P.) at maximum material condition.

ITEM	MILLIMETERS	INCHES
A	10.4 MAX.	0.410 MAX.
B	7.0	0.276
C	1.2 MIN.	0.047 MIN.
D	17.0 ^{±0.3}	0.669 ^{+0.012} _{-0.013}
E	φ3.3 ^{±0.2}	φ0.130 ^{+0.008}
F	0.75 ^{±0.10}	0.030 ^{+0.004} _{-0.005}
G	0.25	0.010
H	2.54 (T.P.)	0.100 (T.P.)
I	5.0 ^{±0.3}	0.197 ^{±0.012}
J	2.66 MAX.	0.105 MAX.
K	4.8 MIN.	0.188 MIN.
L	8.5	0.335
M	8.5	0.335
N	4.5 ^{±0.2}	0.177 ^{±0.008}
P	2.8 ^{±0.2}	0.110 ^{+0.008} _{-0.008}
Q	22.4 MAX.	0.882 MAX.
U	2.4 ^{±0.5}	0.094 ^{+0.021} _{-0.020}
V	0.65 ^{±0.10}	0.026 ^{+0.004} _{-0.005}
Y	8.9 ^{±0.7}	0.350 ^{±0.028}
Z	1.0 MIN.	0.039 MIN.

RECOMMENDED SOLDERING CONDITIONS

The following conditions (see table below) must be met when soldering this product.

Please consult with our sales offices in case other soldering process is used, or in case soldering is done under different conditions.

TYPES OF THROUGH HOLE MOUNT DEVICE

μPC2400AHF Series

Soldering Process	Soldering Conditions	Symbol
Wave soldering	Solder temperature: 260 °C or below. Flow Time: 10 seconds or below.	

REFERENCE

Document Name	Document No.
NEC semiconductor device reliability/quality control system.	IEI-1212
Quality grade on NEC semiconductor devices.	IEI-1209
Semiconductor device mounting technology manual.	IEI-1207
Semiconductor device package manual.	IEI-1213
Guide to quality assurance for semiconductor devices.	MEI-1202
Semiconductor selection guide.	MF-1134

[MEMO]

No part of this document may be copied or reproduced in any form or by any means without the prior written consent of NEC Corporation. NEC Corporation assumes no responsibility for any errors which may appear in this document.

NEC Corporation does not assume any liability for infringement of patents, copyrights or other intellectual property rights of third parties by or arising from use of a device described herein or any other liability arising from use of such device. No license, either express, implied or otherwise, is granted under any patents, copyrights or other intellectual property rights of NEC Corporation or others.

While NEC Corporation has been making continuous effort to enhance the reliability of its semiconductor devices, the possibility of defects cannot be eliminated entirely. To minimize risks of damage or injury to persons or property arising from a defect in an NEC semiconductor device, customer must incorporate sufficient safety measures in its design, such as redundancy, fire-containment, and anti-failure features.

NEC devices are classified into the following three quality grades:

“Standard”, “Special”, and “Specific”. The Specific quality grade applies only to devices developed based on a customer designated “quality assurance program” for a specific application. The recommended applications of a device depend on its quality grade, as indicated below. Customers must check the quality grade of each device before using it in a particular application.

Standard: Computers, office equipment, communications equipment, test and measurement equipment, audio and visual equipment, home electronic appliances, machine tools, personal electronic equipment and industrial robots

Special: Transportation equipment (automobiles, trains, ships, etc.), traffic control systems, anti-disaster systems, anti-crime systems, safety equipment and medical equipment (not specifically designed for life support)

Specific: Aircrafts, aerospace equipment, submersible repeaters, nuclear reactor control systems, life support systems or medical equipment for life support, etc.

The quality grade of NEC devices in “Standard” unless otherwise specified in NEC's Data Sheets or Data Books. If customers intend to use NEC devices for applications other than those specified for Standard quality grade, they should contact NEC Sales Representative in advance.

Anti-radioactive design is not implemented in this product.