

PROTECTION CIRCUIT FOR OCL POWER AMPLIFIER  
AND SPEAKER

- . Over current detecting circuit  
Operation at the time of over load, such as a speaker terminal short.
- . DC voltage detecting circuit  
Operation at the time when positive or negative DC voltage ( $\pm 1.1V$  of detection level) has generated at output terminals.
- . Muting circuit  
Transient noise protection when power is ON-OFF.
- . Relay driver circuit (Drive current of 130mA at Max.)
- . Operation by dual power supply.

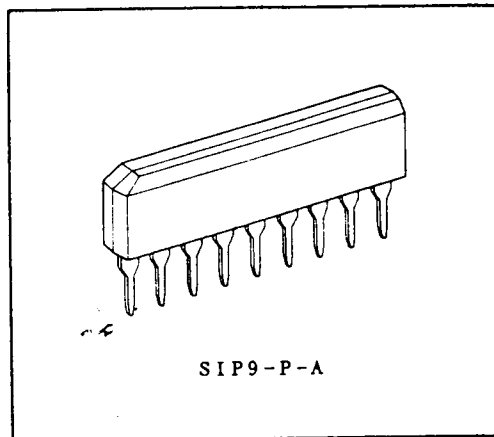

SIP9-P-A

Weight: 0.9g(Typ.)

MAXIMUM RATINGS ( $T_a=25^{\circ}C$ )

CHARACTERISTIC	SYMBOL	RATING	UNIT
Supply Voltage	$V_{CC}$	60	V
Relay Driver Output Current	$I_{OUT}$	130	mA
Power Dissipation	$P_D$	500	mW
Operating Temperature	$T_{opr}$	-20 ~ 75	$^{\circ}C$
Storage Temperature	$T_{stg}$	-55 ~ 150	$^{\circ}C$

ELECTRICAL CHARACTERISTICS ( $V_{CC}=\pm 50V$ ,  $T_a=25^{\circ}C$ )

CHARACTERISTIC	SYMBOL	TEST CIR-CUIT	TEST CONDITION	MIN.	TYP.	MAX.	UNIT
Supply Current	$I_{CC ON}$	-	$V_1 IN=-5V$ , $\pm V_{DC}=0V$ , SW:OFF	-	54	-	mA
	$I_{CC OFF}$	-	$V_1 IN=0V$ , $\pm V_{DC}=0V$ , SW:OFF	1.5	2.4	4	
DC Detector Voltage	$+V_{DC}$	-	Note 1	0.9	1.1	1.3	V
	$-V_{DC}$	-	Note 1	-0.9	-1.1	-1.3	
Output Voltage	$V_{OUT(ON)}$	-	$V_1 IN=-5V$ , $\pm V_{DC}=0V$ , SW:OFF	-	1	2	V
	$V_{OUT(OFF)}$	-	$V_1 IN=0V$ , $\pm V_{DC}=0V$ , SW:OFF	-	50	-	
Muting Time at Power ON	M.T ( $V_{CC ON}$ )	-	Note 2	-	4	-	sec
Muting Time with Load Shorted	M.T	-	Note 3	-	3.5	-	sec
Pin 8 Entering Current	$I_8$	-	-	2	8	-	$\mu A$
Pin 9 Terminal Voltage	$V_9$	-	-	-	3.1	-	V
Pin 1 Terminal Voltage	$V_1$	-	-	-	0.75	-	V
Pin 5 Terminal Voltage	$V_5$	-	-	-	-0.75	-	V

MAXIMUM INTO OR OUT CURRENT

CHARACTERISTIC	SYMBOL	RATING	UNIT
Pin 1 Current	$I_1$	$\pm 1.0$	mA
Pin 2 Current	$I_2$	$\pm 1.0$	mA
Pin 3 Current	$I_3$	$\pm 1.0$	mA
Pin 5 Current	$I_5$	-6.0	mA
Pin 7 Current	$I_7$	1.0	mA
Pin 9 Current	$I_9$	5.0	mA

EQUIVALENT CIRCUIT

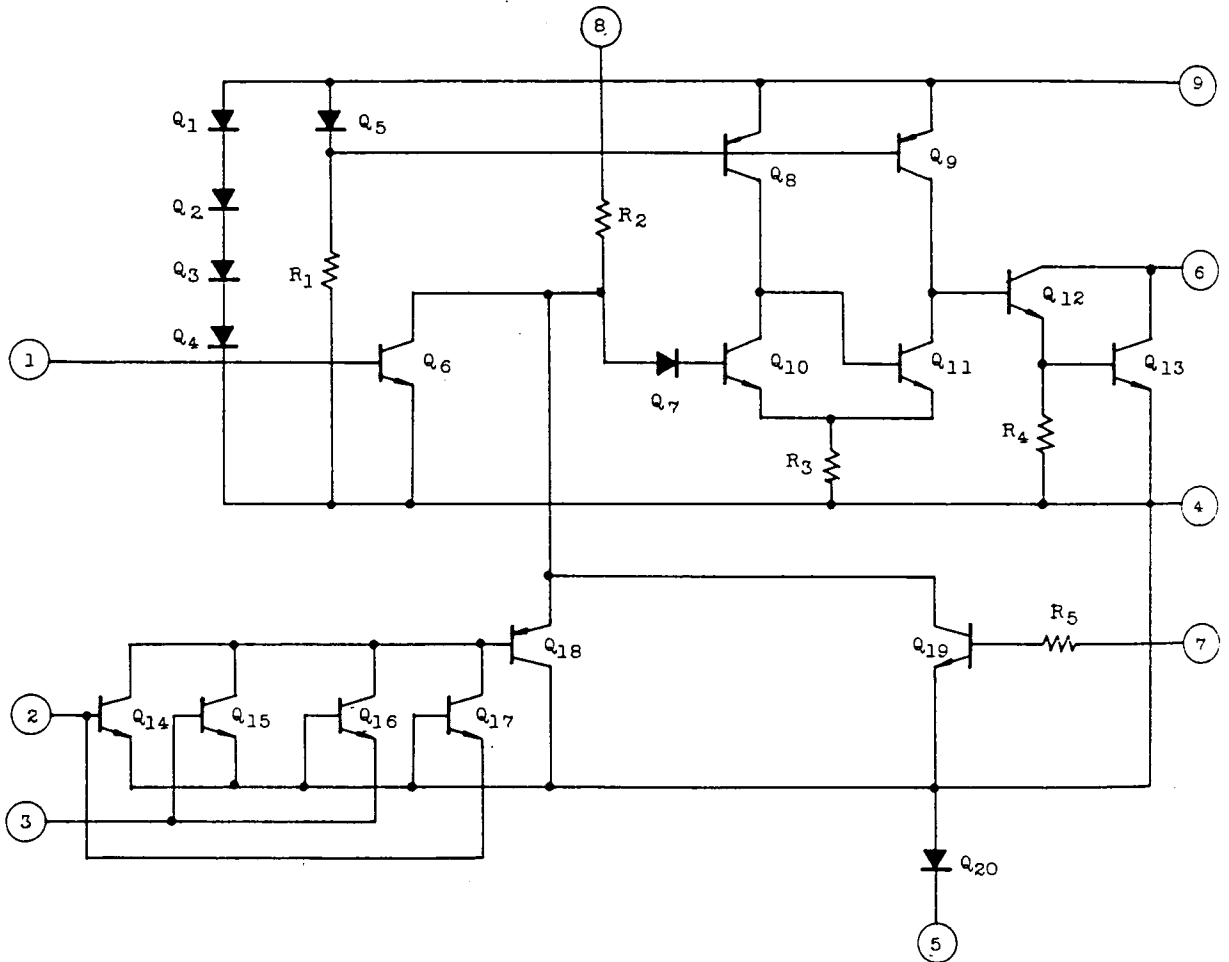

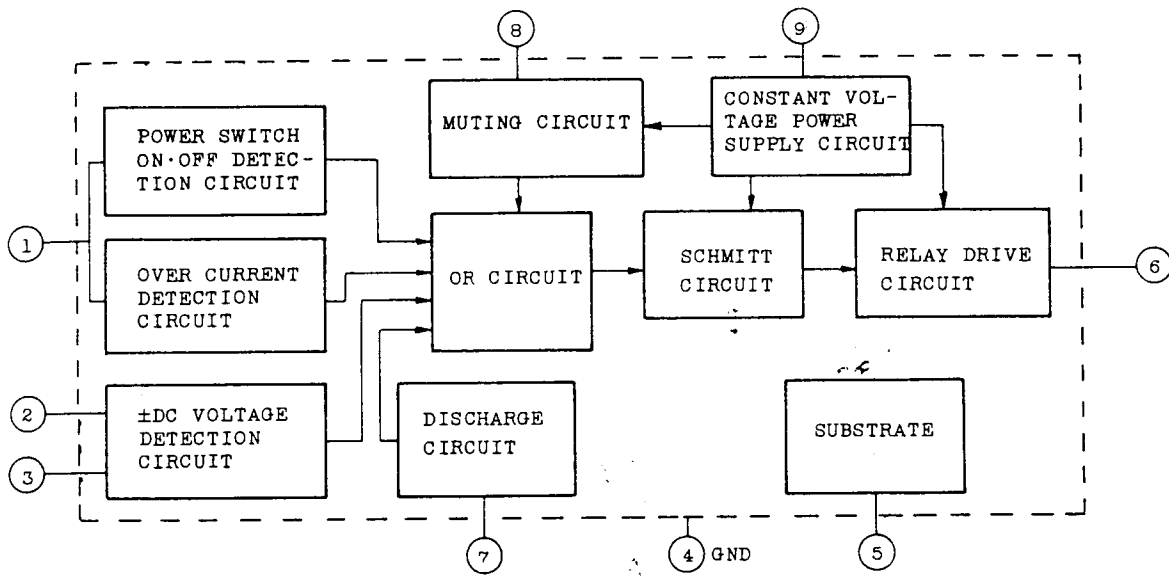

TEST CIRCUIT

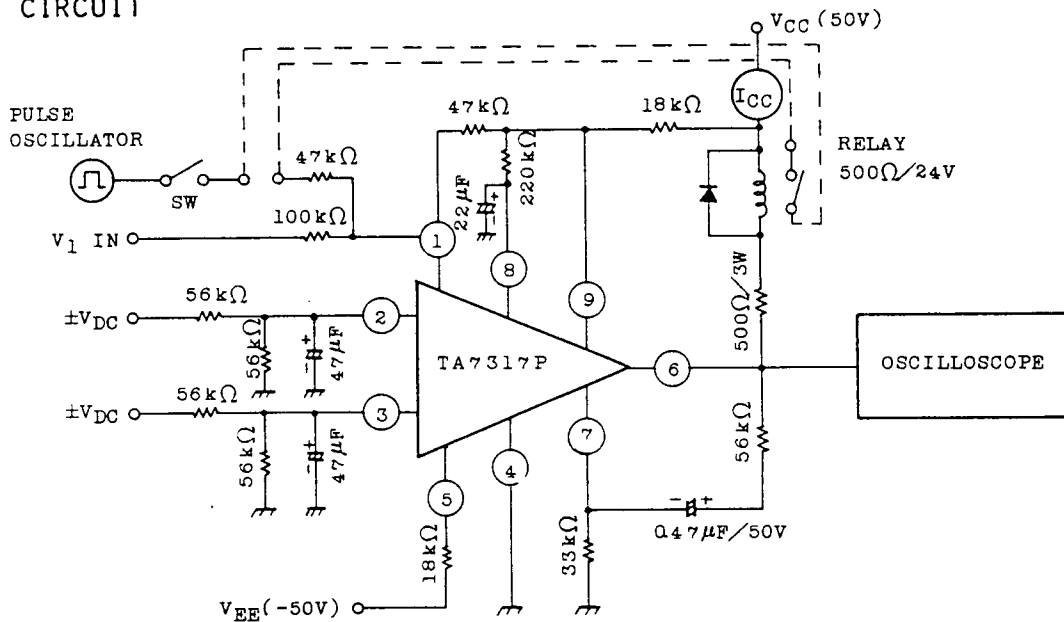

- (Note) 1. The value of  $\pm V_{DC}$  at the time when the relay is turned from ON to OFF in the condition of  $V_1 IN = -5V$  and SW-OFF.
2. The time required for the relay being turned from OFF to ON at  $+V_{CC}$  ON in the condition of  $V_1 IN = -5V$ ,  $\pm V_{DC} = 0V$ , and SW-OFF.
3. The duration of the relay being able to keep OFF when SW is turned ON in the condition of  $V_1 IN = -5V$  and  $\pm V_{DC} = 0V$ . At that time input pulse is 3ms, -3V.

