

9097247 TOSHIBA. ELECTRONIC

02E 17003 D

T-74-05-01

TA7274P**12W BTL AUDIO POWER AMPLIFIER**

The TA7274P is audio power amplifier for consumer application.

This IC is applying BTL system in which output coupling condenser and bootstrap condenser are not necessary and output 12W ($V_{CC}=13.2V$, $R_L=4\Omega$, THD=10%) can be obtained.

Since the package is a 7 pin SIP, (Single Inline Package), it greatly simplifies construction of a power amplifier both in design and assembly.

It also contains various kind of protector. It is suitable for car-audio power amplifier with high performance.

- High Power : $P_{OUT}=12W(Typ.)$
($V_{CC}=13.2V$, $f=1kHz$, THD=10%, $R_L=4\Omega$)
- Built in Protector Circuit
Thermal Shut Down, Over Voltage Protector (Typ. $V_{CC}=24V$)
ASO Protector (R_L Short, Out to GND, Out to VCC)
- Operating Supply Voltage Range : $V_{CC}=9\sim 18V$

Unit in mm

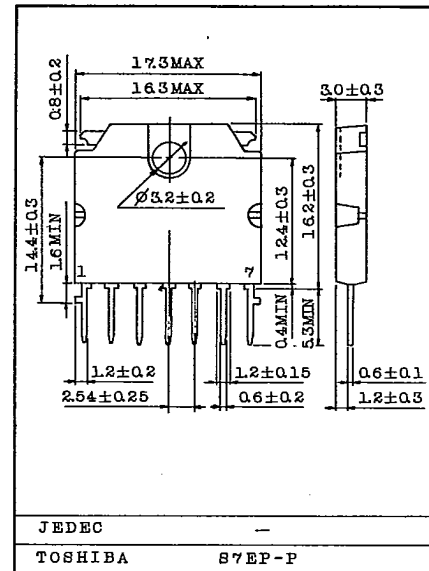

Weight : 2.19g (TYP.)

MAXIMUM RATINGS (Ta=25°C)

CHARACTERISTIC	SYMBOL	RATING	UNIT
Peak Supply Voltage (0.2 sec)	VCC surge	45	V
DC Supply Voltage	VCC DC	25	V
Operating Supply Voltage	VCC opr	18	V
Output Current (Peak)	IO(peak)	4.5	A
Power Dissipation	PD	15	W
Operating Temperature	Topr	-30 ~ 85	°C
Storage Temperature	Tstg	-55 ~ 150	°C

TOSHIBA

TA7274P

T-74-05-01

TEST CIRCUIT/APPLICATION CIRCUIT

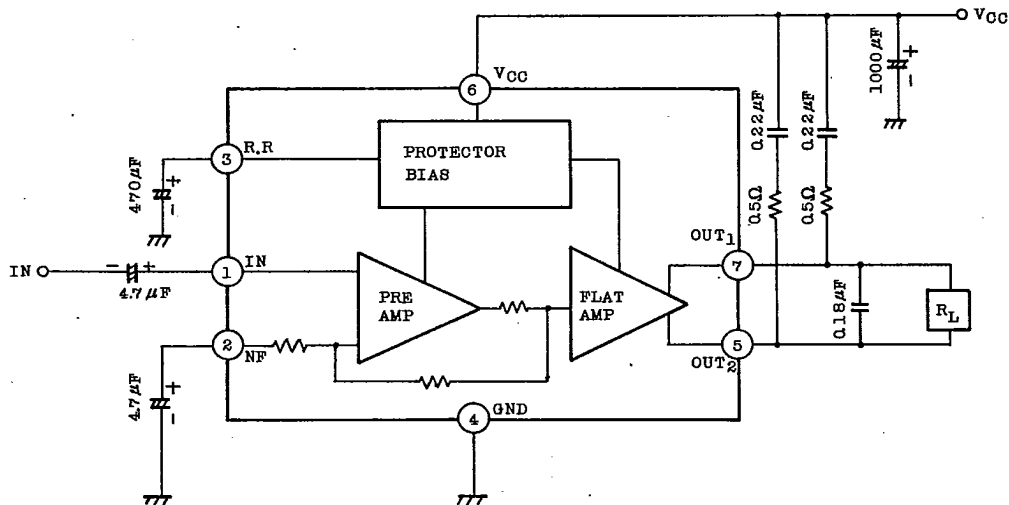

ELECTRICAL CHARACTERISTICS

(Unless otherwise specified, $V_{CC}=13.2V$, $R_L=4\Omega$, $f=1kHz$, $T_a=25^\circ C$)

CHARACTERISTIC	SYMBOL	TEST CIR-CUIT	TEST CONDITION	MIN.	TYP.	MAX.	UNIT
Quiescent Current	I_{CCQ}	-	$V_{IN}=0$	-	65	110	mA
Output Power	P_{OUT}	-	THD=10%	10	12	-	W
Total Harmonic Distortion	THD	-	$P_{OUT}=5W$	-	0.4	1	%
Voltage Gain	G_v	-	$R_f=0\Omega$	51	53	55	dB
Output Noise Voltage	V_{NO}	-	$R_g=10k\Omega$, BW=20Hz ~ 20kHz	-	0.9	2.0	mVrms
Ripple Rejection Ratio	R.R	-	$f_{ripple}=100Hz$, $R_g=600\Omega$	40	50	-	dB
Input Resistance	R_{IN}	-	$f=1kHz$	-	30	-	$k\Omega$
Output Offset Voltage	V_{offset}	-	$V_{IN}=0$	-	0	0.3	V

TYPICAL DC VOLTAGE OF EACH TERMINAL ($V_{CC}=13.2V$, $T_a=25^\circ C$)

TERMINAL No.	1	2	3	4	5	6	7
DC Voltage (V)	5.4	5.4	5.4	GND	6.6	V_{CC}	6.6

AUDIO LINEAR IC

TA7274P

T-74-05-01

DIRECTIONS FOR USE AND APPLICATION METHOD

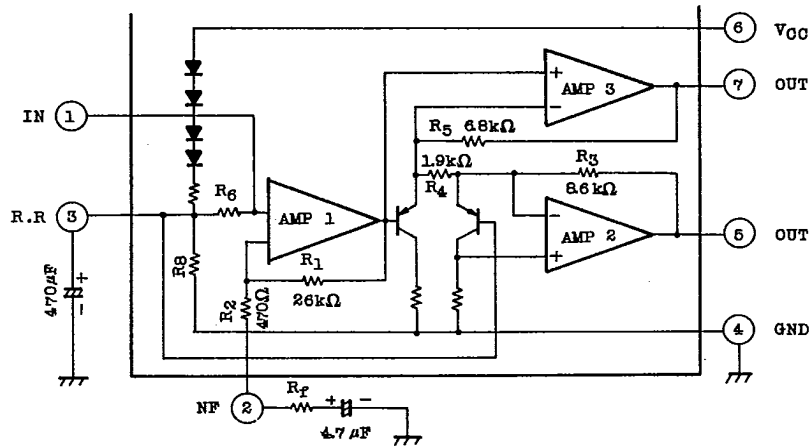

(Fig. 1)

1. VOLTAGE GAIN ADJUSTMENT

In (Fig. 1), let closed loop voltage gain of initial stage AMP: Amp 1 be G_{V1} , then

$$G_{V1} \approx 20 \log \frac{R_1}{R_2 + R_f} \text{ (dB)} \quad (R_1 \gg R_2 + R_f)$$

Also, let closed loop voltage gains of non-inverted AMP: Amp 2 and inverted AMP: Amp 3 be G_{V2} and G_{V3} , respectively, then,

$$G_{V2} = 20 \log \frac{R_3}{R_4}, \quad G_{V3} = 20 \log \frac{R_4 + R_5}{R_4} \approx 13 \text{ (dB)} \quad (G_{V2} \approx G_{V3}).$$

Hence, the total closed circuit voltage gain G_V is given by BTL connection as follows:

$$G_V = G_{V1} + G_{V2} + 6 = G_{V1} + 19 \text{ (dB)}.$$

For instance, in the case of $R_f = 0$, $G_V = 54 \text{ (dB)}$ setting can be made.

TA7274P

T-74-05-01

When the dead short detecting circuit has operated, a lock condition is realized and the power transistor is protected.

(2) **V_{CC}-FAULT PROTECTIVE CIRCUIT** (Circuit between OUT and V_{CC} is shorted.)

Block diagram of V_{CC}-fault Protective Circuit is shown in (Fig. -3).

This circuit makes a similar operation to the GND-fault protective circuit.

In the case of half-short, the dead-short detecting circuit operates by the rise of output terminal up to V_{CC} level, and protects the power transistor.

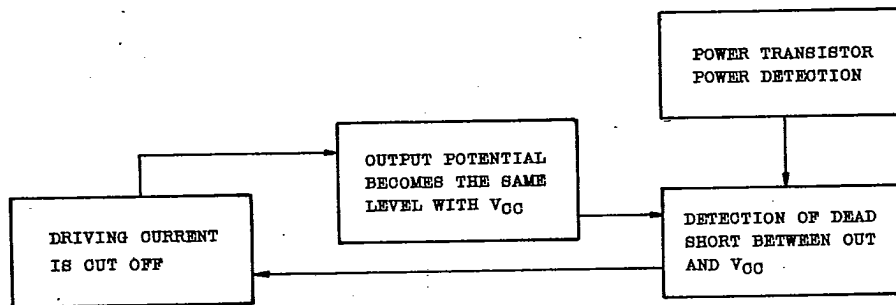

Fig. 3 V_{CC} FAULT PROTECTIVE CIRCUIT

(3) **R_L SHORT PROTECTIVE CIRCUIT** (Circuit between OUT and OUT is shorted.)

It cuts off driving current by the power transistor power detecting circuit of GND-fault and V_{CC} fault, protective circuit, and protects the power transistor.

AUDIO LINEAR IC

TA7274P

T-74-05-01

3. OSCILLATION PREVENTION

In this IC, GND pin [(4) pin] has only one terminal, and the inside of IC is divided by into Pre-GND and Power-GND. For this reason, pay attention to the following points in making design.

- (1) Install the chemical condenser between VCC and GND near IC pin as much as possible.
- (2) Drop heat sink to ((4) Pin) GND. (To prevent the deterioration of distortion.)
- (3) Use oscillation preventive condenser between output VCC, characteristic of which is not so much affected by temperature. When using ceramic condenser, adopt the value larger than the recommended value, as the characteristic of ceramic condenser is apt to be changed by temperature.

In this case, never fail to execute temperature test and check oscillation allowance.

TOSHIBA

TA7274P

T-74-05-01

Recommended oscillation stopping condenser capacity and series resistance value is $0.22\mu\text{F}$ and 0.5Ω , respectively.

Before using, fully examine the type and mounting position of condenser.

There is a possibility of oscillation when contact resistance is produced by the use of IC socket.

(4) CAPACITY VALUE OF CHEMICAL CONDENSER

When the values of input coupling and NF condenser are different, pop Noise is produce. Therefore, it is recommended, to equalize the capacity values and adopt $4.7\mu\text{F}$.

(Fig. -5) shows the characteristic when the capacity of ripple condenser is varied.

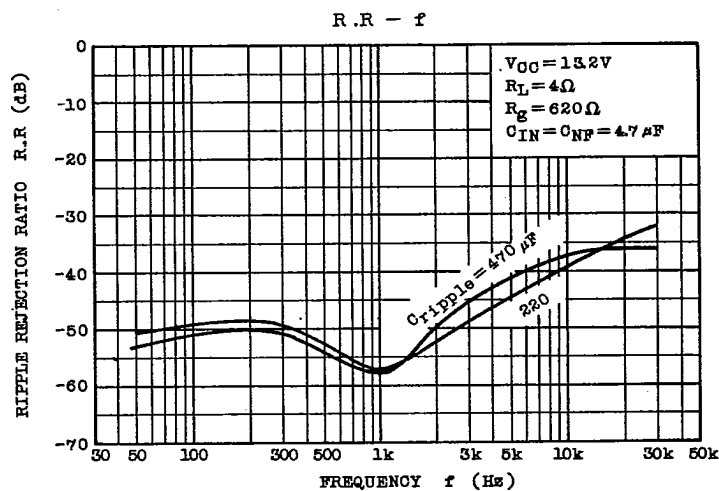

(Fig.-5) R.R - f

AUDIO LINEAR IC

TA7274P

T-74-05-01

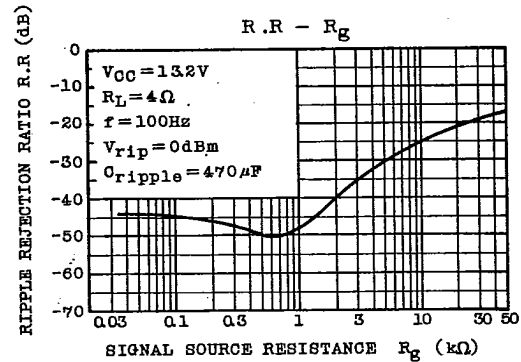
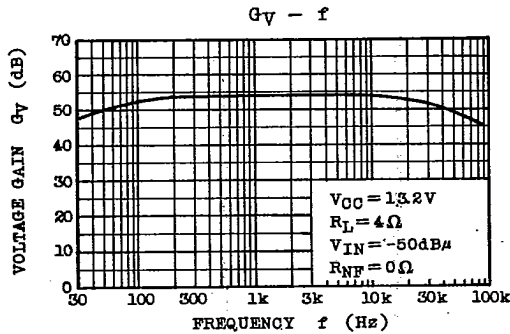
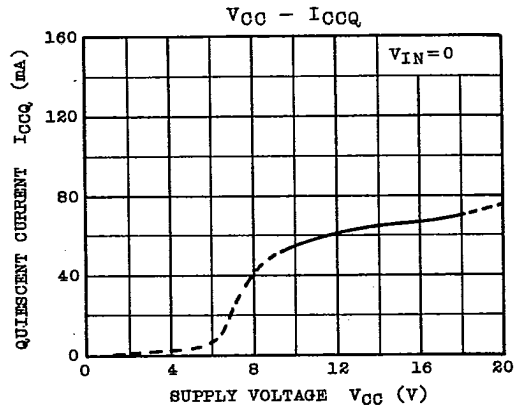
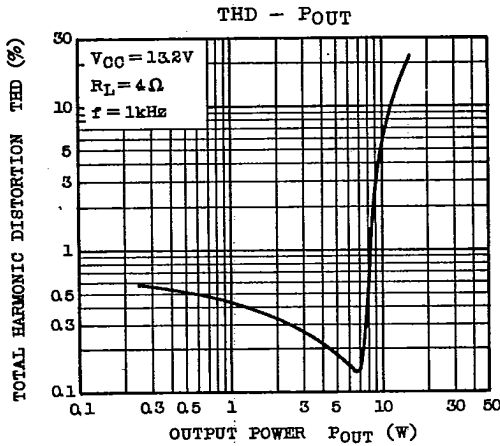
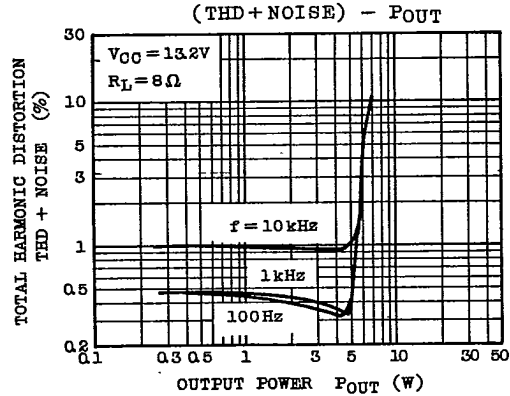
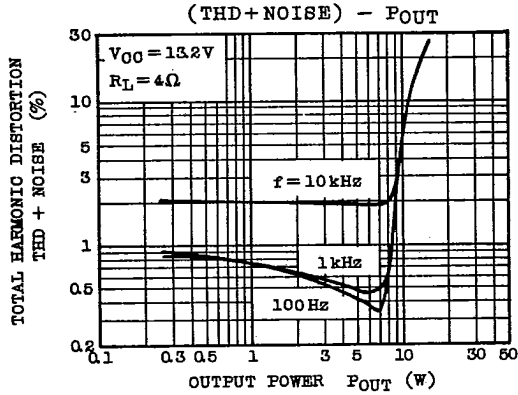

TOSHIBA

TA7274P

T-74-05-01

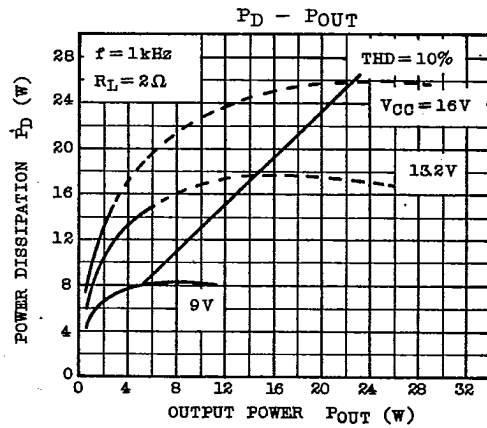
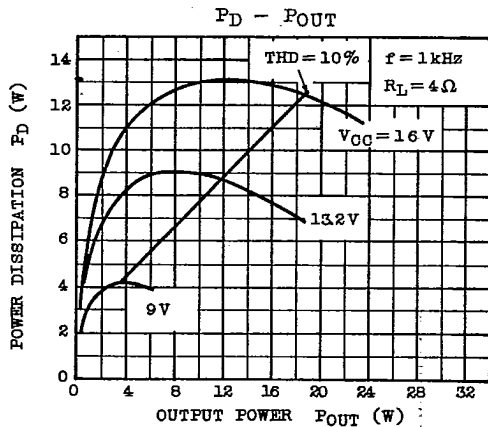
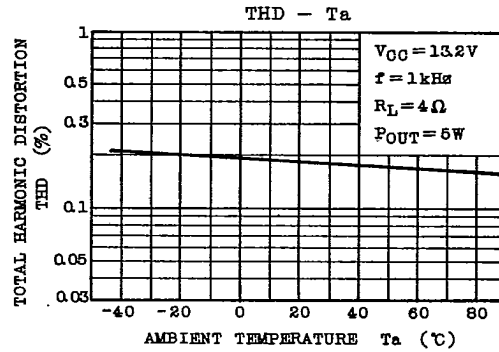
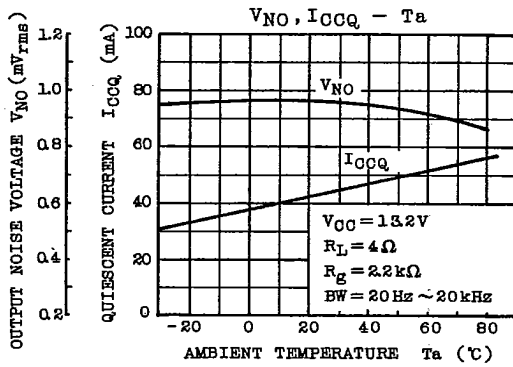
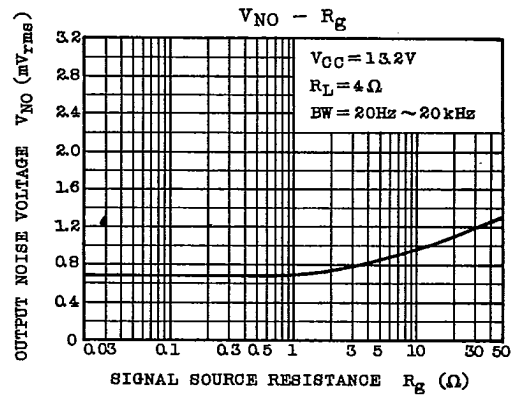
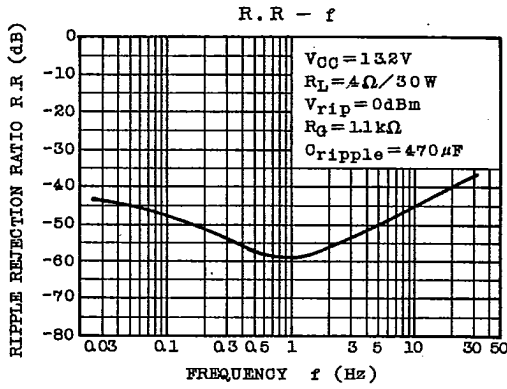

AUDIO LINEAR IC

TA7274P

T-74-05-01

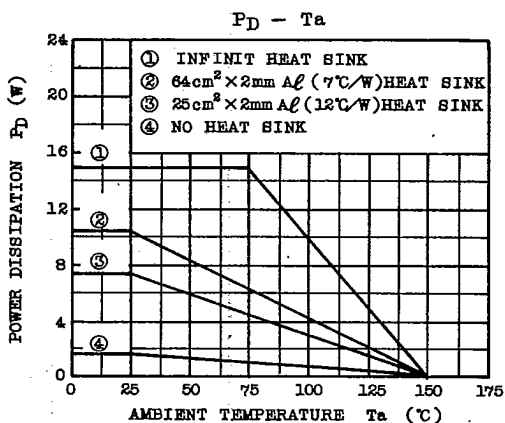
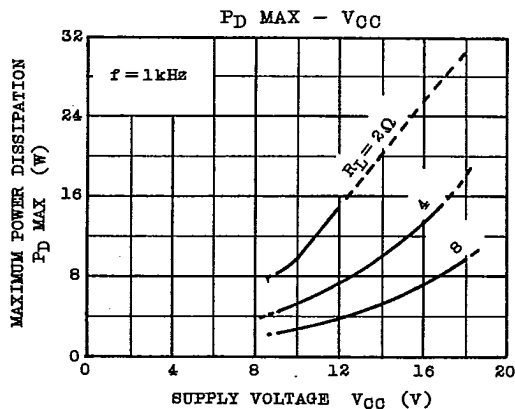
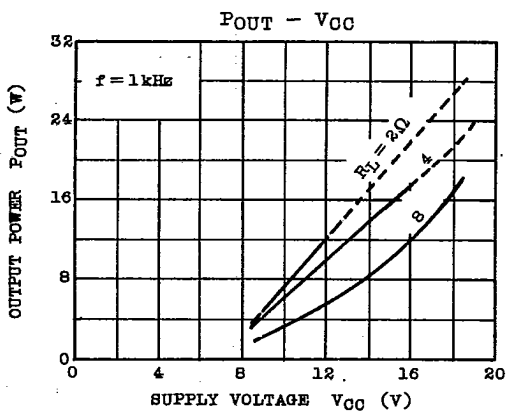

TOSHIBA